

GENERAL DESCRIPTION

This high voltage MOSFET uses an advanced termination scheme to provide enhanced voltage-blocking capability without degrading performance over time. In addition, this advanced MOSFET is designed to withstand high energy in avalanche and commutation modes. The new energy efficient design also offers a drain-to-source diode with a fast recovery time. Designed for high voltage, high speed switching applications in power supplies, converters and PWM motor controls, these devices are particularly well suited for bridge circuits where diode speed and commutating safe operating areas are critical and offer additional and safety margin against unexpected voltage transients.

FEATURES

- ◆ Robust High Voltage Termination
- ◆ Avalanche Energy Specified
- ◆ Source-to-Drain Diode Recovery Time Comparable to a Discrete Fast Recovery Diode
- ◆ Diode is Characterized for Use in Bridge Circuits
- ◆ I_{BSS} and $V_{DS(on)}$ Specified at Elevated Temperature

PIN CONFIGURATION

TO-220
Top View

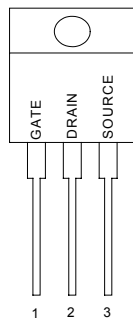

SYMBOL

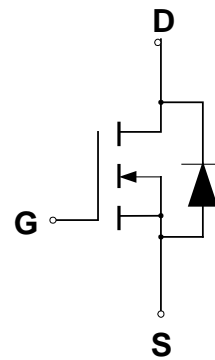

N-Channel MOSFET

ABSOLUTE MAXIMUM RATINGS

Rating	Symbol	Value	Unit
Drain to Current - Continuous	I_D	10	A
- Pulsed	I_{DM}	40	
Gate-to-Source Voltage - Continue	V_{GS}	± 20	V
- Non-repetitive	V_{GSM}	± 40	V
Total Power Dissipation	P_D	125	W
Derate above 25		1.0	W/
Operating and Storage Temperature Range	T_J, T_{STG}	-55 to 150	
Single Pulse Drain-to-Source Avalanche Energy - $T_J = 25$ ($V_{DD} = 100V, V_{GS} = 10V, I_L = 10A, L = 6mH, R_G = 25\Omega$)	E_{AS}	300	mJ
Thermal Resistance - Junction to Case	θ_{JC}	1.7	/W
- Junction to Ambient	θ_{JA}	62.5	
Maximum Lead Temperature for Soldering Purposes, 1/8" from case for 10 seconds	T_L	260	

ORDERING INFORMATION

Part Number	Package
CMT10N40N220	TO-220

ELECTRICAL CHARACTERISTICS

Unless otherwise specified, $T_J = 25$.

Characteristic		Symbol	CMT10N40			Units
			Min	Typ	Max	
Drain-Source Breakdown Voltage ($V_{GS} = 0\text{ V}$, $I_D = 250\ \mu\text{A}$)		$V_{(BR)DSS}$	400			V
Drain-Source Leakage Current ($V_{DS} = 400\text{ V}$, $V_{GS} = 0\text{ V}$) ($V_{DS} = 400\text{ V}$, $V_{GS} = 0\text{ V}$, $T_J = 125$)		I_{DSS}			25 250	μA
Gate-Source Leakage Current-Forward ($V_{gsf} = 20\text{ V}$, $V_{DS} = 0\text{ V}$)		I_{GSSF}			100	nA
Gate-Source Leakage Current-Reverse ($V_{gsr} = 20\text{ V}$, $V_{DS} = 0\text{ V}$)		I_{GSSR}			100	nA
Gate Threshold Voltage ($V_{DS} = V_{GS}$, $I_D = 250\ \mu\text{A}$)		$V_{GS(th)}$	2.0		4.0	V
Static Drain-Source On-Resistance ($V_{GS} = 10\text{ V}$, $I_D = 5.0\text{A}$) *		$R_{DS(on)}$			0.55	Ω
Drain-Source On-Voltage ($V_{GS} = 10\text{ V}$) ($I_D = 5.0\text{ A}$)		$V_{DS(on)}$			6.0	V
Forward Transconductance ($V_{DS} = 50\text{ V}$, $I_D = 5.0\text{A}$) *		g_{FS}	5.8			mhos
Input Capacitance	$(V_{DS} = 25\text{ V}$, $V_{GS} = 0\text{ V}$, $f = 1.0\text{ MHz}$)	C_{iss}		1570		pF
Output Capacitance		C_{oss}		230		pF
Reverse Transfer Capacitance		C_{rss}		55		pF
Turn-On Delay Time	$(V_{DD} = 200\text{ V}$, $I_D = 10.0\text{ A}$, $V_{GS} = 10\text{ V}$, $R_G = 10\Omega$) *	$t_{d(on)}$		25		ns
Rise Time		t_r		37		ns
Turn-Off Delay Time		$t_{d(off)}$		75		ns
Fall Time		t_f		31		ns
Total Gate Charge	$(V_{DS} = 320\text{ V}$, $I_D = 10.0\text{ A}$, $V_{GS} = 10\text{ V}$)*	Q_g		46	63	nC
Gate-Source Charge		Q_{gs}		10		nC
Gate-Drain Charge		Q_{gd}		23		nC
Internal Drain Inductance (Measured from the drain lead 0.25" from package to center of die)		L_D		4.5		nH
Internal Drain Inductance (Measured from the source lead 0.25" from package to source bond pad)		L_S		7.5		nH
SOURCE-DRAIN DIODE CHARACTERISTICS						
Forward On-Voltage(1)	$(I_S = 10.0\text{ A}$, $V_{GS} = 0\text{ V}$, $d_I/d_t = 100\text{A}/\mu\text{s}$)	V_{SD}			1.5	V
Forward Turn-On Time		t_{on}		**		ns
Reverse Recovery Time		t_{rr}		250		ns

* Pulse Test: Pulse Width 300 μs , Duty Cycle 2%

** Negligible, Dominated by circuit inductance

TYPICAL ELECTRICAL CHARACTERISTICS

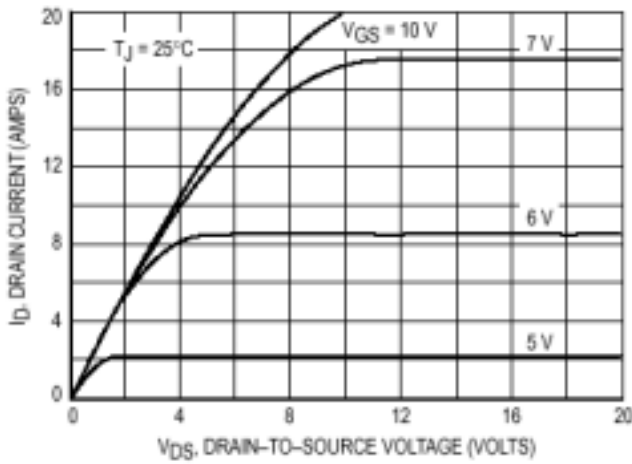

Figure 1. On-Region Characteristics

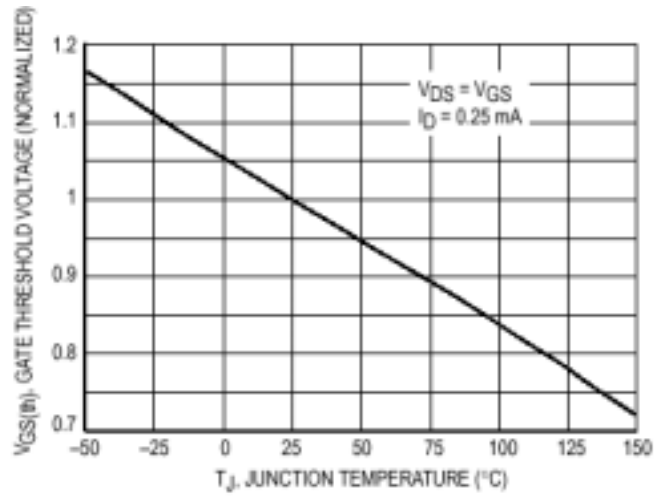

Figure 2. Gate-Threshold Voltage Variation With Temperature

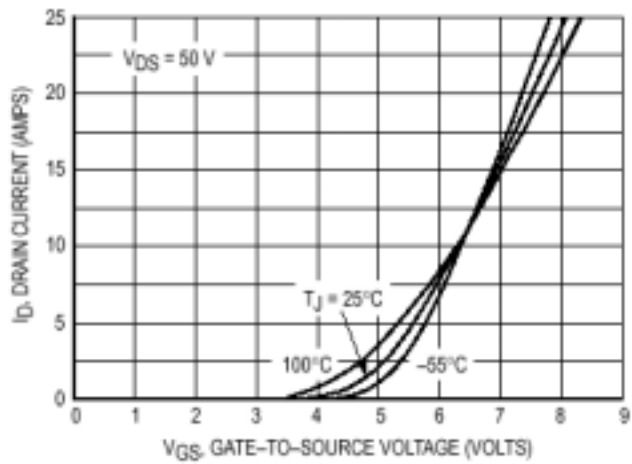

Figure 3. Transfer Characteristics

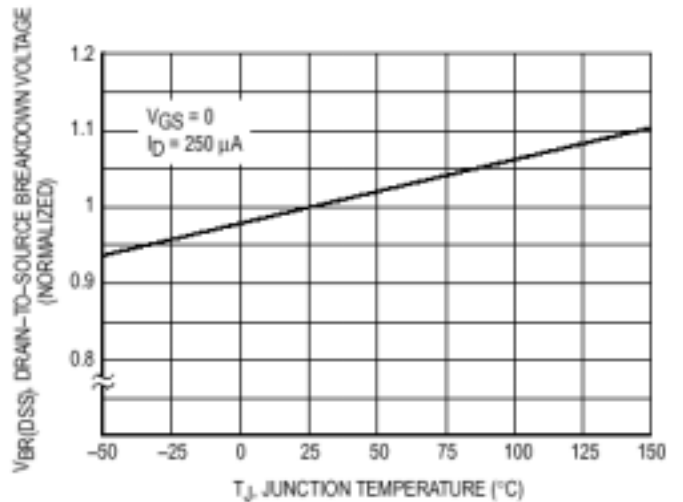

Figure 4. Breakdown Voltage Variation With Temperature

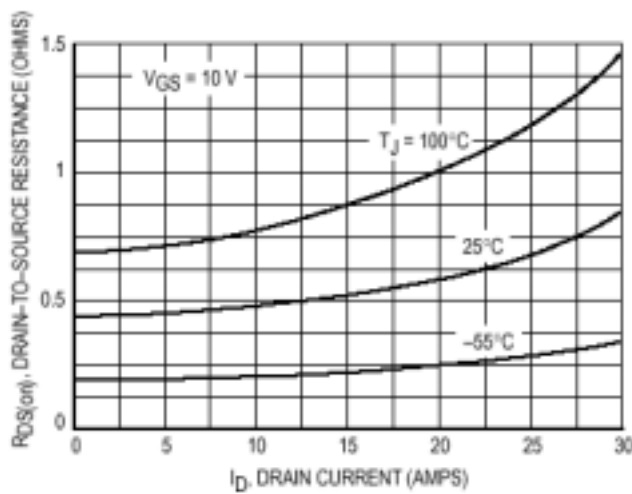

Figure 5. On-Resistance versus Drain Current

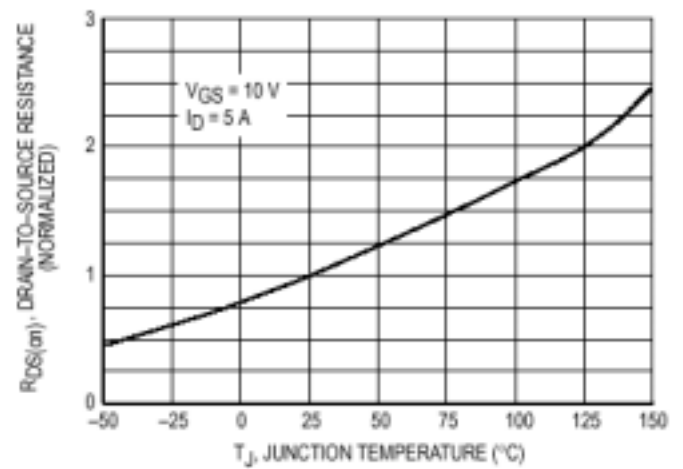
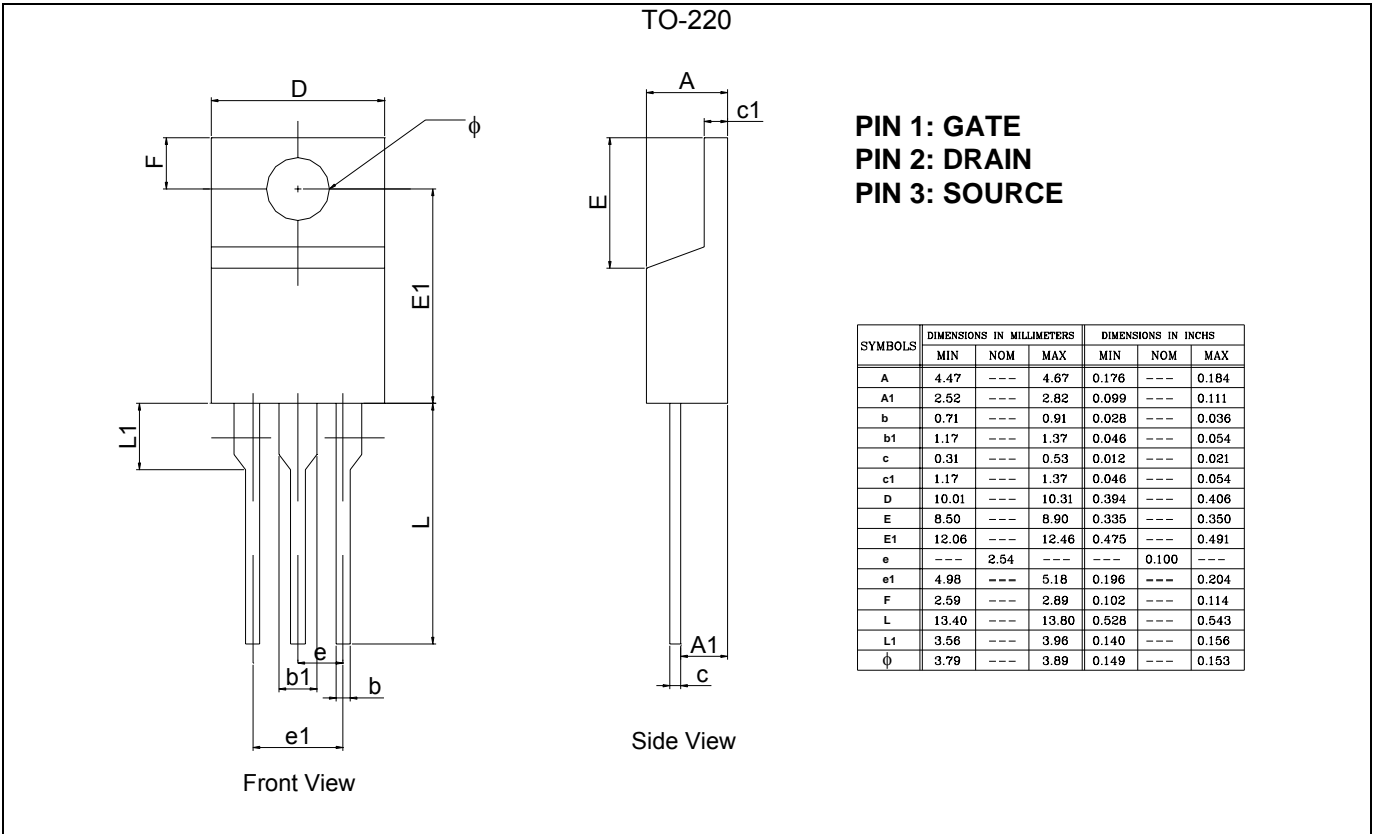

Figure 6. On-Resistance Variation With Temperature

PACKAGE DIMENSION



IMPORTANT NOTICE

Champion Microelectronic Corporation (CMC) reserves the right to make changes to its products or to discontinue any integrated circuit product or service without notice, and advises its customers to obtain the latest version of relevant information to verify, before placing orders, that the information being relied on is current.

A few applications using integrated circuit products may involve potential risks of death, personal injury, or severe property or environmental damage. CMC integrated circuit products are not designed, intended, authorized, or warranted to be suitable for use in life-support applications, devices or systems or other critical applications. Use of CMC products in such applications is understood to be fully at the risk of the customer. In order to minimize risks associated with the customer's applications, the customer should provide adequate design and operating safeguards.

HsinChu Headquarter

5F, No. 11, Park Avenue II,
Science-Based Industrial Park,
HsinChu City, Taiwan
TEL: +886-3-567 9979
FAX: +886-3-567 9909

Sales & Marketing

11F, No. 306-3, SEC. 1, Ta Tung Road,
Hsichih, Taipei Hsien 221, Taiwan
TEL: +886-2-8692 1591
FAX: +886-2-8692 1596
