

Open Carrier Double-Balanced Mixer For Microwave Telecommunications

MC2313
V2

Features

- LO 2.2 TO 8.0 GHz
- RF 3.4 TO 7.0 GHz
- IF DC TO 2.0 GHz
- LO DRIVE +13 dBm (NOMINAL)
- MICROSTRIP INTERFACE

Description

The MC2313 is a double balanced mixer, designed for use in military, commercial and test equipment applications. The design utilizes Schottky ring quad diodes and broadband soft dielectric and ferrite baluns to attain excellent performance. This mixer can also be used as a phase detector and/or bi-phase modulator since the IF port is DC coupled to the diodes. The use of high temperature solder and welded assembly processes used internally makes it ideal for use in manual, semi-automated assembly. Environmental screening available to MIL-STD-883, MIL-STD-202, or MIL-DTL-28837, consult factory.

Product Image

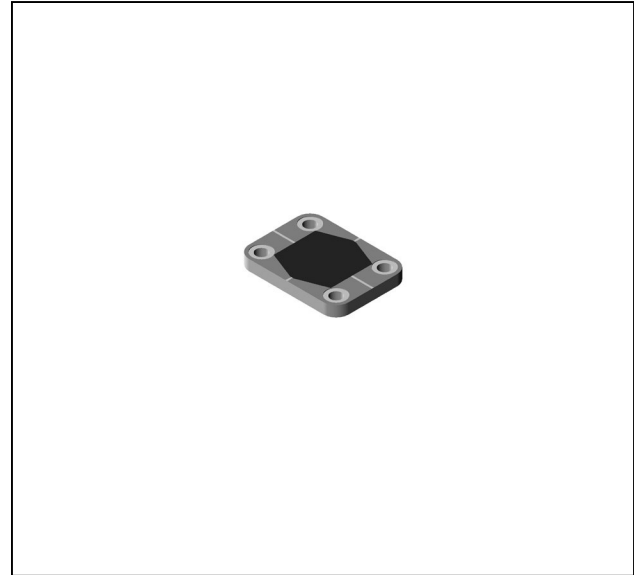

Ordering Information

Part Number	Package
MC2313	Open Carrier
MC2313-2	Open Carrier

Electrical Specifications: $Z_0 = 50\Omega$ $L_o = +13$ dBm (Downconverter application only)

Parameter	Test Conditions	Units	Typical	Guaranteed	
				+25°C	-54° to +85°C
SSB Conversion Loss (max) & SSB Noise Figure (max)	fR=3.4 to 7 GHz, fL=2.2 to 8 GHz, fl=0.05 to 0.5 GHz	dB	5.2	7.0	7.3
	fR=3.4 to 7 GHz, fL=2.2 to 8 GHz, fl=0.05 to 1.5 GHz	dB	6.5	8.0	8.5
	fR=3.4 to 7 GHz, fL=2.2 to 8 GHz, fl=0.05 to 2 GHz	dB	7.0	8.5	9.0
Isolation, L to R (min)	fL = 2.2 to 3 GHz	dB	25	18	16
	fL = 3 to 8 GHz	dB	40	28	26
Isolation, L to I (min)	fL = 2.2 to 3 GHz	dB	20	13	11
	fL = 3 to 4 GHz	dB	30	18	16
	fL = 4 to 8 GHz	dB	42	30	28
Isolation, R to I (min)	fL = 3.4 to 7 GHz	dB	26		
1 dB Conversion Comp.	fL = +13 dBm	dBm	+7		
Input IP3	fR1 = 4.2 GHz at -10 dBm, fR2 = 4.21 at -10 dBm, fL = 2.7 GHz at +13 dBm	dBm	+16		
	fR1 = 6 GHz at -10 dBm, fR2 = 6.01 at -10 dBm, fL = 4.5 GHz at +13 dBm	dBm	+17		

1

M/A-COM Inc. and its affiliates reserve the right to make changes to the product(s) or information contained herein without notice. M/A-COM makes no warranty, representation or guarantee regarding the suitability of its products for any particular purpose, nor does M/A-COM assume any liability whatsoever arising out of the use or application of any product(s) or information.

- **North America** Tel: 800.366.2266 / Fax: 978.366.2266
- **Europe** Tel: 44.1908.574.200 / Fax: 44.1908.574.300
- **Asia/Pacific** Tel: 81.44.844.8296 / Fax: 81.44.844.8298

Visit www.macom.com for additional data sheets and product information.

**Open Carrier Double-Balanced Mixer
For Microwave Telecommunications**

MC2313
V2

Typical Performance Curves

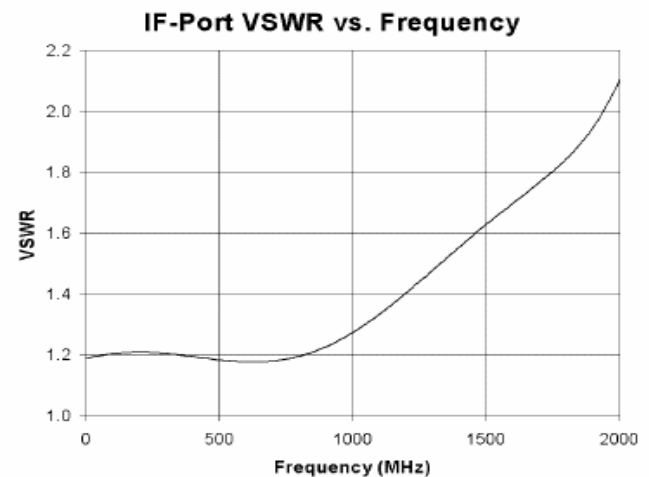
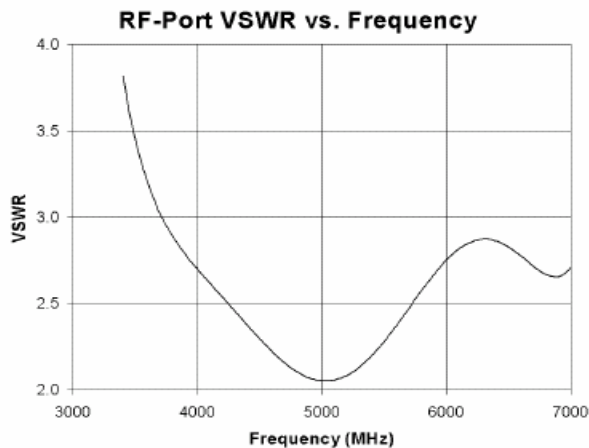
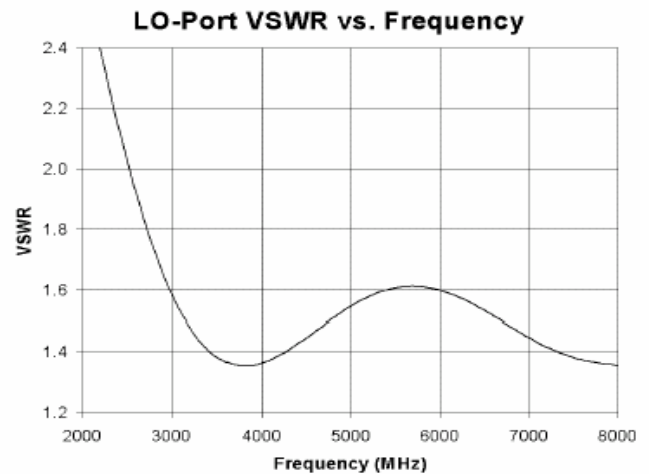
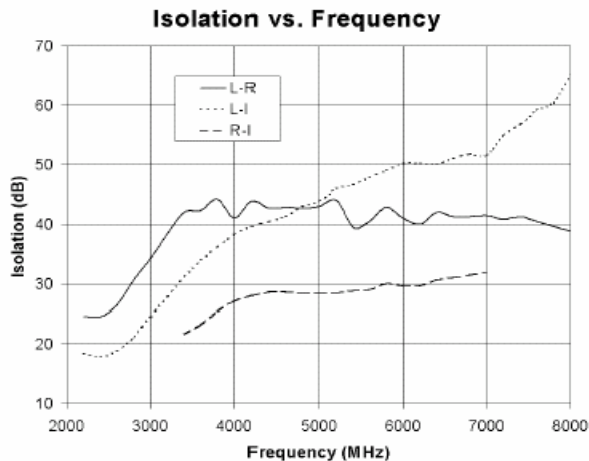
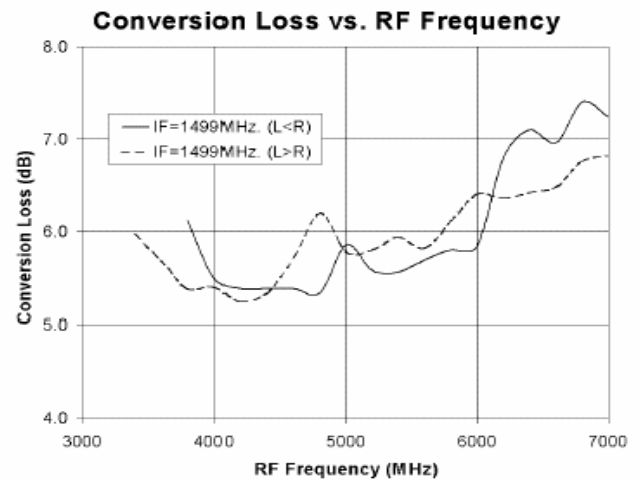
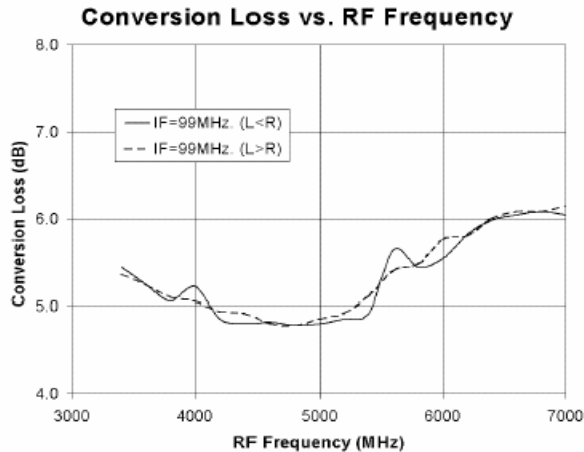

**Open Carrier Double-Balanced Mixer
For Microwave Telecommunications**

MC2313
V2

Absolute Maximum Ratings

Parameter	Absolute Maximum
Operating Temperature	-54°C to +85°C
Storage Temperature	-65°C to +100°C
Peak Input Power	+23 dBm max @ +25°C +20 dBm max @ +85°C
Peak Input Current	50 mA DC

Outline Drawing: Open Carrier *MC2313

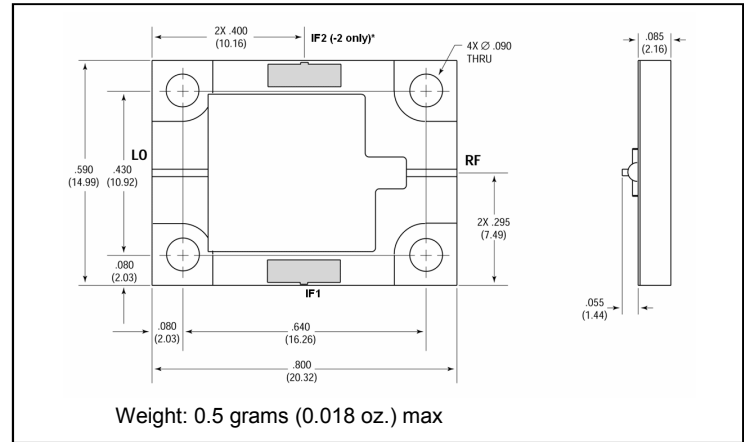

*For the base model, only the IF1 port is connected.
For the “-2” model only the IF2 port is connected.

* Dimensions are inches (millimeters) ±0.015 (0.38) unless otherwise specified.