

# DATA SHEET

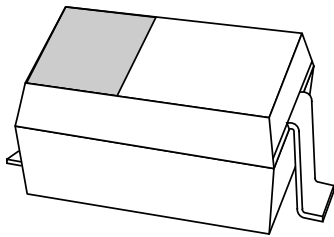

## **PMEG1020EA**

Ultra low  $V_F$  MEGA Schottky barrier diode

Preliminary specification

2003 Mar 07

# Ultra low $V_F$ MEGA Schottky barrier diode

# PMEG1020EA

## FEATURES

- Forward current: 2 A
- Reverse voltage: 10 V
- Ultra low forward voltage
- Very small plastic SMD package.

## APPLICATIONS

- Low voltage rectification
- High efficiency DC/DC conversion
- Switch mode power supply
- Inverse polarity protection
- Low power consumption applications.

## DESCRIPTION

Planar Maximum Efficiency General Application (MEGA) Schottky barrier diode with an integrated guard ring for stress protection, encapsulated in a SOD323 (SC-76) very small SMD plastic package.

## PINNING

PIN	DESCRIPTION
1	cathode
2	anode

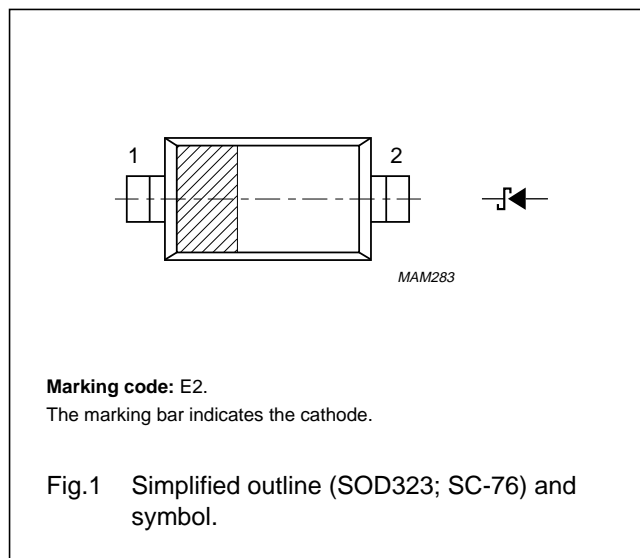

## LIMITING VALUES

In accordance with the Absolute Maximum Rating System (IEC 60134).

SYMBOL	PARAMETER	CONDITIONS	MIN.	MAX.	UNIT
$V_R$	continuous reverse voltage		–	10	V
$I_F$	continuous forward current	$T_{sp} \leq 55\text{ }^\circ\text{C}$	–	2	A
$I_{FRM}$	repetitive peak forward current	$t_p \leq 1\text{ ms}; \delta \leq 0.5$	–	3.2	A
$I_{FSM}$	non-repetitive peak forward current	$t_p = 8\text{ ms square wave}$	–	9	A
$T_{stg}$	storage temperature		–65	+150	$^\circ\text{C}$
$T_j$	junction temperature		–	150	$^\circ\text{C}$
$T_{amb}$	operating ambient temperature		–65	+150	$^\circ\text{C}$

Ultra low  $V_F$  MEGA Schottky barrier diode

## PMEG1020EA

**ELECTRICAL CHARACTERISTICS** $T_{amb} = 25\text{ }^\circ\text{C}$  unless otherwise specified.

SYMBOL	PARAMETER	CONDITIONS	TYP.	MAX.	UNIT
$V_F$	forward voltage	see Fig.2; note 1			
		$I_F = 0.01\text{ A}$	100	130	mV
		$I_F = 0.1\text{ A}$	170	200	mV
		$I_F = 1\text{ A}$	280	350	mV
		$I_F = 2\text{ A}$	350	460	mV
$I_R$	reverse current	see Fig.3; note 2			
		$V_R = 5\text{ V}$	0.7	2	mA
		$V_R = 8\text{ V}$	1	2.5	mA
		$V_R = 10\text{ V}$	1.2	3	mA
$C_d$	diode capacitance	$V_R = 5\text{ V}$ ; $f = 1\text{ MHz}$ ; see Fig.4	37	45	pF

**Notes**

1. Pulse test:  $t_p = 300\text{ }\mu\text{s}$ ;  $\delta = 0.02$ .
2. For Schottky barrier diodes thermal runaway has to be considered, as in some applications the reverse power losses ( $P_R$ ) are a significant part of the total power losses.

**THERMAL CHARACTERISTICS**

SYMBOL	PARAMETER	CONDITIONS	VALUE	UNIT
$R_{th\ j-a}$	thermal resistance from junction to ambient	note 1	450	K/W
		note 2	210	K/W
$R_{th\ j-s}$	thermal resistance from junction to solder point	note 3	90	K/W

**Notes**

1. Refer to SOD323 (SC-76) standard mounting conditions.
2. Device mounted on an FR4 printed-circuit board with copper clad 10 x 10 mm.
3. Solder point of cathode tab.

Ultra low  $V_F$  MEGA Schottky barrier diode

PMEG1020EA

GRAPHICAL DATA

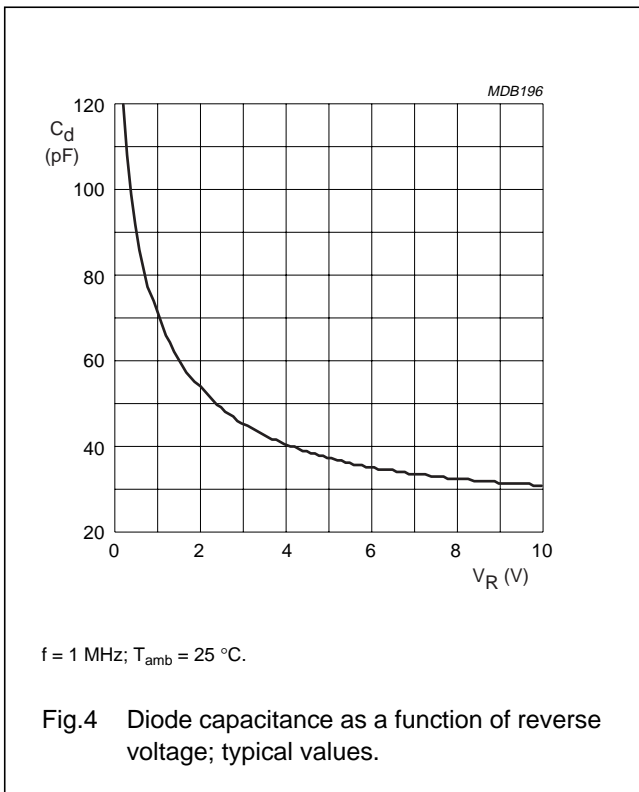
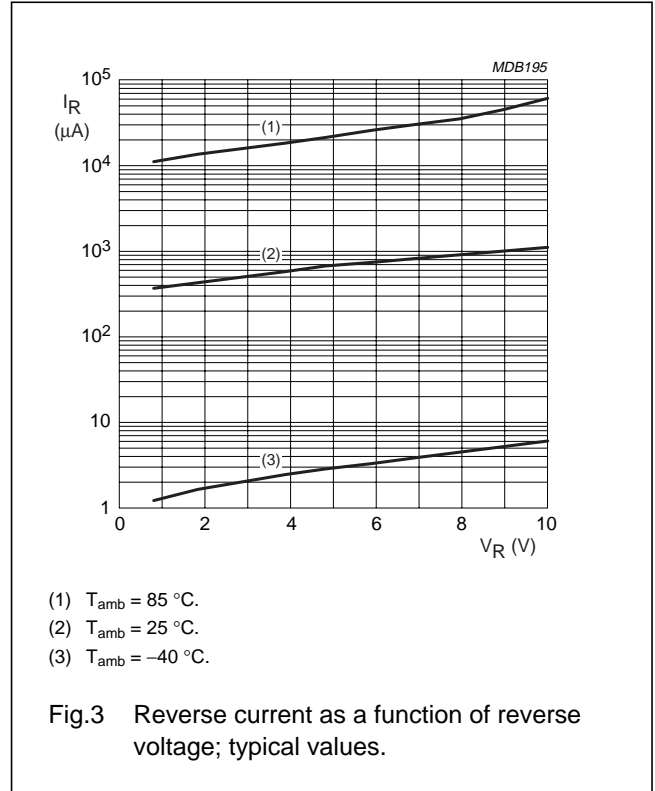
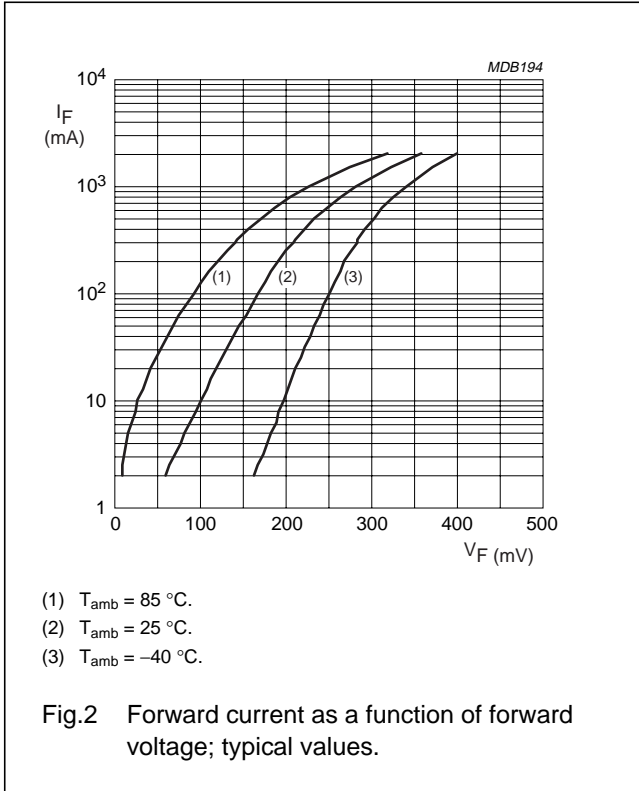

Ultra low  $V_F$  MEGA Schottky barrier diode

PMEG1020EA

PACKAGE OUTLINE

Plastic surface mounted package; 2 leads

SOD323

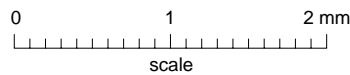
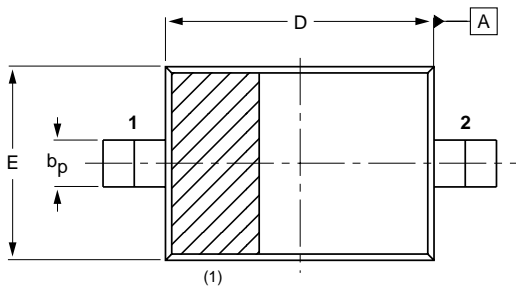
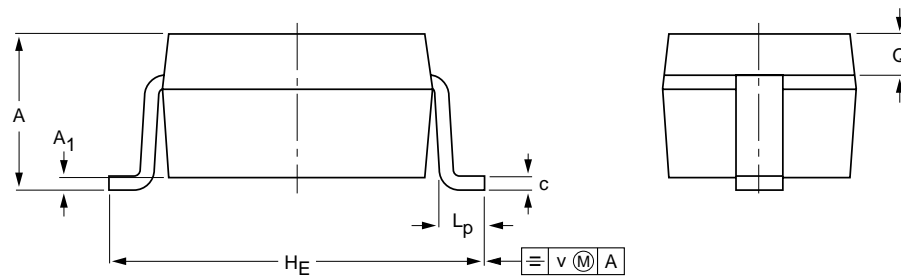

DIMENSIONS (mm are the original dimensions)

UNIT	A	A <sub>1</sub> max.	bp	c	D	E	H <sub>E</sub>	L <sub>p</sub>	Q	v
mm	1.1 0.8	+0.05 -0.05	0.40 0.25	0.25 0.10	1.8 1.6	1.35 1.15	2.7 2.3	0.45 0.15	0.25 0.15	0.2

Note

1. The marking bar indicates the cathode.

OUTLINE VERSION	REFERENCES				EUROPEAN PROJECTION	ISSUE DATE
	IEC	JEDEC	EIAJ			
SOD323			SC-76			98-09-14 99-09-13

Ultra low  $V_F$  MEGA Schottky barrier diode

## PMEG1020EA

## DATA SHEET STATUS

LEVEL	DATA SHEET STATUS <sup>(1)</sup>	PRODUCT STATUS <sup>(2)(3)</sup>	DEFINITION
I	Objective data	Development	This data sheet contains data from the objective specification for product development. Philips Semiconductors reserves the right to change the specification in any manner without notice.
II	Preliminary data	Qualification	This data sheet contains data from the preliminary specification. Supplementary data will be published at a later date. Philips Semiconductors reserves the right to change the specification without notice, in order to improve the design and supply the best possible product.
III	Product data	Production	This data sheet contains data from the product specification. Philips Semiconductors reserves the right to make changes at any time in order to improve the design, manufacturing and supply. Relevant changes will be communicated via a Customer Product/Process Change Notification (CPCN).

## Notes

1. Please consult the most recently issued data sheet before initiating or completing a design.
2. The product status of the device(s) described in this data sheet may have changed since this data sheet was published. The latest information is available on the Internet at URL <http://www.semiconductors.philips.com>.
3. For data sheets describing multiple type numbers, the highest-level product status determines the data sheet status.

## DEFINITIONS

**Short-form specification** — The data in a short-form specification is extracted from a full data sheet with the same type number and title. For detailed information see the relevant data sheet or data handbook.

**Limiting values definition** — Limiting values given are in accordance with the Absolute Maximum Rating System (IEC 60134). Stress above one or more of the limiting values may cause permanent damage to the device. These are stress ratings only and operation of the device at these or at any other conditions above those given in the Characteristics sections of the specification is not implied. Exposure to limiting values for extended periods may affect device reliability.

**Application information** — Applications that are described herein for any of these products are for illustrative purposes only. Philips Semiconductors make no representation or warranty that such applications will be suitable for the specified use without further testing or modification.

## DISCLAIMERS

**Life support applications** — These products are not designed for use in life support appliances, devices, or systems where malfunction of these products can reasonably be expected to result in personal injury. Philips Semiconductors customers using or selling these products for use in such applications do so at their own risk and agree to fully indemnify Philips Semiconductors for any damages resulting from such application.

**Right to make changes** — Philips Semiconductors reserves the right to make changes in the products - including circuits, standard cells, and/or software - described or contained herein in order to improve design and/or performance. When the product is in full production (status 'Production'), relevant changes will be communicated via a Customer Product/Process Change Notification (CPCN). Philips Semiconductors assumes no responsibility or liability for the use of any of these products, conveys no licence or title under any patent, copyright, or mask work right to these products, and makes no representations or warranties that these products are free from patent, copyright, or mask work right infringement, unless otherwise specified.

Ultra low  $V_F$  MEGA Schottky barrier diode

PMEG1020EA

---

**NOTES**

# Philips Semiconductors – a worldwide company

## Contact information

For additional information please visit <http://www.semiconductors.philips.com>. Fax: +31 40 27 24825

For sales offices addresses send e-mail to: [sales.addresses@www.semiconductors.philips.com](mailto:sales.addresses@www.semiconductors.philips.com).

© Koninklijke Philips Electronics N.V. 2003

SCA75

All rights are reserved. Reproduction in whole or in part is prohibited without the prior written consent of the copyright owner.

The information presented in this document does not form part of any quotation or contract, is believed to be accurate and reliable and may be changed without notice. No liability will be accepted by the publisher for any consequence of its use. Publication thereof does not convey nor imply any license under patent- or other industrial or intellectual property rights.

Printed in The Netherlands

513514/1500/01/pp8

Date of release: 2003 Mar 07

Document order number: 9397 750 11024

*Let's make things better.*

