

KV-20TS29/20TS32

KV-21STR2/2170RS

RM-Y116

SERVICE MANUAL



RM-Y116

US Model

KV-20TS29 Chassis No. SCC-F78A-A

KV-20TS32 Chassis No. SCC-F78B-A

Canadian Model

KV-20TS29 Chassis No. SCC-F79A-A

WP Model

KV-21STR2 Chassis No. SCC-F81A-A

E Model

KV-2170RS Chassis No. SCC-F80A-A

BA-1 CHASSIS

MODELS OF THE SAME SERIES

KV-20TS29/20TS32	
KV-21STR2/2170RS	
KV-20TR23/2160WR/2150R	

SPECIFICATIONS

Television system	American TV standards	Speaker output	2W×2 (8 ohms)
Channel coverage	VHF: 2-13 UHF: 14-69 CABLE TV: 1-125	Speaker size	Full range 50×90 mm (2×3 ⁵ / ₈ in.)× 2 units
Picture tube	Hi-Black Trinitron® tube 20-inch picture measured diagonally 21-inch picture tube measured diagonally	Audio frequency response	50Hz-20kHz
Antenna	75 ohm external antenna terminal for VHF/UHF	Power requirements	120V AC, 60Hz 110-127V or 220-240V AC, 50-60Hz (KV-21STR2 only)
Input	VIDEO and S VIDEO S VIDEO IN (S terminal) (KV-20TS32) Y: 1Vp-p, 75-ohms unbalanced, sync negative C: 0.286Vp-p (Barst signal) 75-ohms	Power consumption	120W
	Video (phono jacks): 1 Vp-p, 75-ohms unbalanced, sync negative	Standby mode	4W
	Audio (phono jacks): 500 mVrms (100% modulation) Impedance: 47 kilohms	Dimensions (w/h/d)	5.5W (KV-21STR2 only) 526×488×471.5 mm (20 ³ / ₄ ×19 ¹ / ₄ ×18 ⁵ / ₈ inches)
		Weight	22.8 kg (50 lbs 4 oz)

- Continued on next page -

TRINITRON® COLOR TV

SONY®

www.DataSheet4U.com



Supplied accessories	Remote Commander RM-Y116 (1) with 2 size AA (R6) EVEREADY batteries Dipole antenna (1) Antenna connector (1) Power cord plug adaptor * (KV-21STR2 only)
Recommended accessories	U/V mixer EAC-66 Connecting cord VMC-810S/820S, VMC-720M YC-15V/30V, RK-74A

*** AC power cord connection**

If the power cord plug cannot be inserted into the wall outlet, use the supplied power cord plug adaptor.

Design and specifications are subject to change without notice.

WARNING!!

AN ISOLATION TRANSFORMER SHOULD BE USED DURING ANY SERVICE TO AVOID POSSIBLE SHOCK HAZARD, BECAUSE OF LIVE CHASSIS. THE CHASSIS OF THIS RECEIVER IS DIRECTLY CONNECTED TO THE AC POWER LINE.

SAFETY-RELATED COMPONENT WARNING !!

COMPONENTS IDENTIFIED BY SHADING AND MARK Δ ON THE SCHEMATIC DIAGRAMS, EXPLODED VIEWS AND IN THE PARTS LIST ARE CRITICAL TO SAFE OPERATION. REPLACE THESE COMPONENTS WITH SONY PARTS WHOSE PART NUMBERS APPEAR AS SHOWN IN THIS MANUAL OR IN SUPPLEMENTS PUBLISHED BY SONY. CIRCUIT ADJUSTMENTS THAT ARE CRITICAL TO SAFE OPERATION ARE IDENTIFIED IN THIS MANUAL. FOLLOW THESE PROCEDURES WHENEVER CRITICAL COMPONENTS ARE REPLACED OR IMPROPER OPERATION IS SUSPECTED.

ATTENTION!!

AFIN D'EVITER TOUT RISQUE D'ELECTROCUTION PROVENANT D'UN CHÂSSIS SOUS TENSION, UN TRANSFORMATEUR D'ISOLEMENT DOIT ETRE UTILISÉ LORS DE TOUT DÉPANNAGE. LE CHÂSSIS DE CE RÉCEPTEUR EST DIRECTEMENT RACCORDÉ À L'ALIMENTATION SECTEUR.

ATTENTION AUX COMPOSANTS RELATIFS À LA SÉCURITÉ!!

LES COMPOSANTS IDENTIFIÉS PAR UNE TRAME ET PAR UNE MAPQUE Δ SUR LES SCHÉMAS DE PRINCIPE, LES VUES EXPLOSÉES ET LES LISTES DE PIÉCES CONT D'UNE IMPORTANCE CRITIQUE POUR LA SÉCURITÉ DU FONCTIONNEMENT. NE LES REMPLACER QUE PAR DES COMPOSANTS SONY DONT LE NUMÉRO DE PIÉCE EST INDIQUÉ DANS LE PRÉSENT MANUEL OU DANS DES SUPPLÉMENTS PUBLIÉS PAR SONY. LES RÉGLAGES DE CIRCUIT DONT L'IMPORTANCE EST CRITIQUE POUR LA SÉCURITÉ DU FONCTIONNEMENT SONT IDENTIFIÉS DANS LE PRÉSENT MANUEL. SUIVRE CES PROCÉDURES LORS DE CHAQUE REMPLACEMENT DE COMPOSANTS CRITIQUES, OU LORSQU'UN MAUVAIS FONCTIONNEMENT EST SUSPECTÉ.

SAFETY CHECK-OUT

(US Model only)

After correcting the original service problem, perform the following safety checks before releasing the set to the customer:

1. Check the area of your repair for unsoldered or poorly-soldered connections. Check the entire board surface for solder splashes and bridges.
2. Check the interboard wiring to ensure that no wires are "pinched" or contact high-wattage resistors.
3. Check that all control knobs, shields, covers, ground straps, and mounting hardware have been replaced. Be absolutely certain that you have replaced all the insulators.
4. Look for unauthorized replacement parts, particularly transistors, that were installed during a previous repair. Point them out to the customer and recommend their replacement.
5. Look for parts which, though functioning, show obvious signs of deterioration. Point them out to the customer and recommend their replacement.
6. Check the line cord for cracks and abrasion. Recommend the replacement of any such line cord to the customer.
7. Check the condition of the monopole antenna (if any).
Make sure the end is not broken off, and has the plastic cap on it. Point out the danger of impalement on a broken antenna to the customer, and recommend the antenna's replacement.
8. Check the B+ and HV to see they are at the values specified. Make sure your instruments are accurate; be suspicious of your HV meter if sets always have low HV.
9. Check the antenna terminals, metal trim, "metallized" knobs, screws, and all other exposed metal parts for AC leakage. Check leakage as described below.

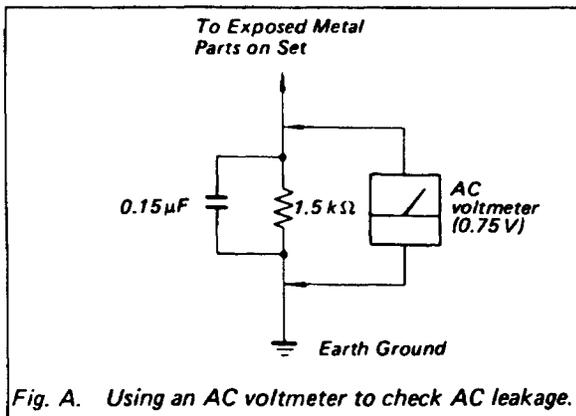
**LEAKAGE TEST**

The AC leakage from any exposed metal part to earth ground and from all exposed metal parts to any exposed metal part having a return to chassis, must not exceed 0.5 mA (500 microamperes). Leakage current can be measured by any one of three methods.

1. A commercial leakage tester, such as the Simpson 229 or RCA WT-540A. Follow the manufacturers' instructions to use these instruments.
2. A battery-operated AC milliammeter. The Data Precision 245 digital multimeter is suitable for this job.
3. Measuring the voltage drop across a resistor by means of a VOM or battery-operated AC voltmeter. The "limit" indication is 0.75 V, so analog meters must have an accurate low-voltage scale. The Simpson 250 and Sanwa SH-63Trd are examples of a passive VOM that is suitable. Nearly all battery operated digital multimeters that have a 2V AC range are suitable. (See Fig. A)

HOW TO FIND A GOOD EARTH GROUND

A cold-water pipe is guaranteed earth ground; the cover-plate retaining screw on most AC outlet boxes is also at earth ground. If the retaining screw is to be used as your earth-ground, verify that it is at ground by measuring the resistance between it and a cold-water pipe with an ohmmeter. The reading should be zero ohms. If a cold-water pipe is not accessible, connect a 60–100 watts trouble light (not a neon lamp) between the hot side of the receptacle and the retaining screw. Try both slots, if necessary, to locate the hot side of the line, the lamp should light at normal brilliance if the screw is at ground potential. (See Fig. B)

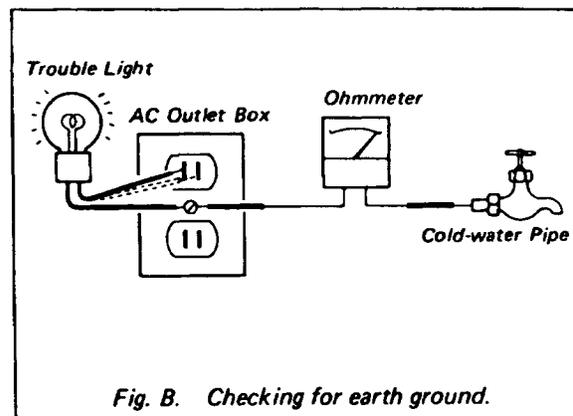

TABLE OF CONTENTS

<u>Section</u>	<u>Title</u>	<u>Page</u>	<u>Section</u>	<u>Title</u>	<u>Page</u>
1.	GENERAL		4.	SAFETY RELATED ADJUSTMENTS	30
1-1.	Identifying Your TV	5	5.	CIRCUIT ADJUSTMENTS	
1-2.	Locating the Controls	6	5-1.	Electrical Adjustment by Remote Commander	32
1-3.	Using the ON-SCREEN Menus	8	5-2.	A Board Adjustments	34
1-4.	Turning the Cable Mode ON or OFF	10	6.	DIAGRAMS	
1-5.	Presetting TV Channels	10	6-1.	Block Diagram	37
1-6.	Connecting Other Equipment	13	6-2.	Circuit Boards Location	41
1-7.	Watching TV Programs	15	6-3.	Printed Wiring Boards and Schematic Diagrams	41
1-8.	Using Convenient Features	15	• A Board	42	
1-9.	Adjusting Picture and Sound Quality	16	• G Board (KV-20TS29/20TS32/2170RS)	49	
1-10.	Using Closed Caption (U.S.A. models only)	18	• G Board (KV-21STR2)	51	
1-11.	Using the Timer-Activated Functions	19	• C Board	54	
1-12.	Customizing the Screen Display	22	• S Board (KV-20TS29/20TS32)	57	
1-13.	Troubleshooting	23	6-4.	Semiconductors	59
2.	DISASSEMBLY		7.	EXPLODED VIEW	
2-1.	Rear Cover Removal	24	7-1.	Chassis	60
2-2.	Service Position	24	8.	ELECTRICAL PARTS LIST	61
2-3.	Picture Tube Removal	25			
3.	SET-UP ADJUSTMENTS				
3-1.	Beam Landing	26			
3-2.	Convergence	27			
3-3.	Focus	29			
3-4.	Screen (G2)	29			
3-5.	Method of Setting the Service Adjustment Mode	29			
3-6.	White Balance Adjustments	29			

1-1. IDENTIFYING YOUR TV

SECTION 1 GENERAL

This section is extracted from instruction manual.

Identifying Your TV

Check the model number of your TV set. This manual covers 11 models and there are slight differences among them. Check the table below to see what your TV is equipped with before you start operating it.

Table of models YES: equipped NO: not equipped

	KV-20TS29 KV-2170RS KV-21STR2	KV-20TS32
MTS stereo	YES	YES
Headphones jack	NO	YES
S video input jack	NO	YES
Front panel AV jacks	NO	YES

* Monaural sound is output by both headphone speakers.

	KV-20TS29	KV-20TS32	KV-2170RS	KV-21STR2
Model destination	U.S.A./Canda		Central South America and other area	
Closed caption	YES**		NO	
Dual Language	NO		YES	

** U.S.A. models only.

Design

KV-20TS29 KV-2170RS
 KV-21STR2

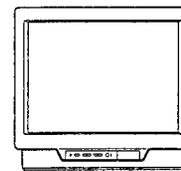

KV-20TS32

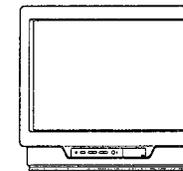

1-2. LOCATING THE CONTROLS

Screen Displays

For details, see the pages indicated by the numbered black circles ●

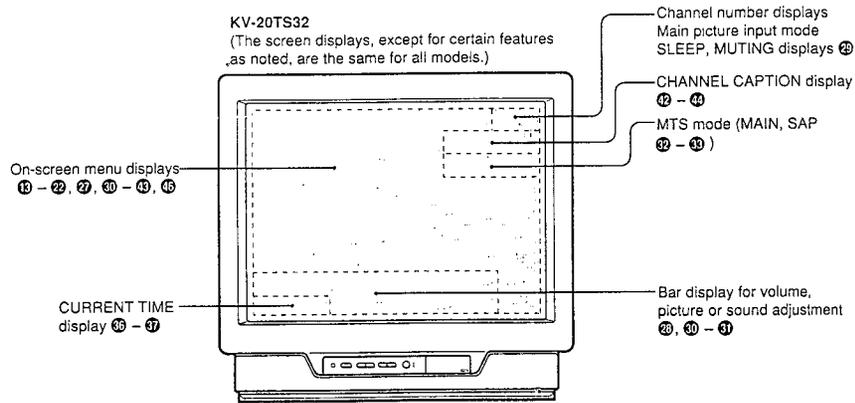

Front Panel

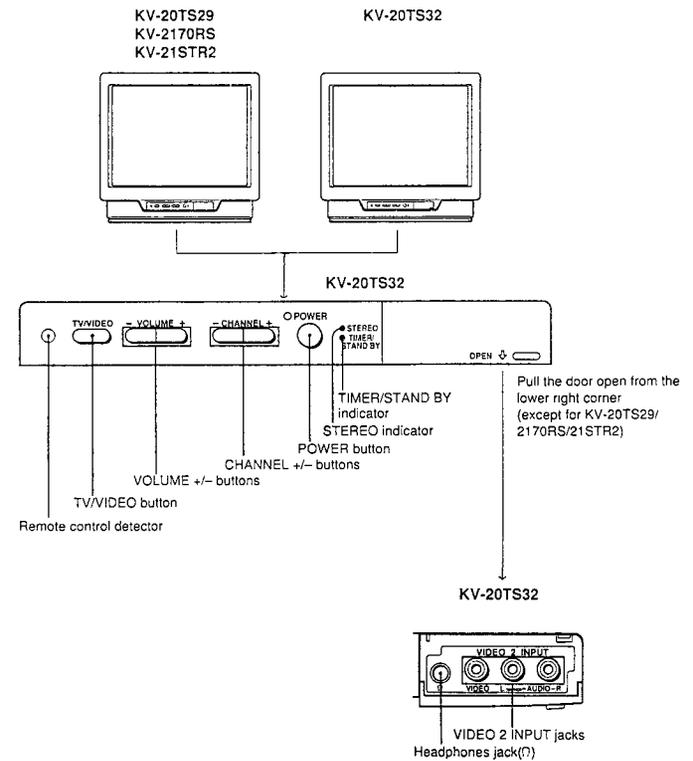

Rear Panel

For details, see the pages indicated by the numbered black circles ●.

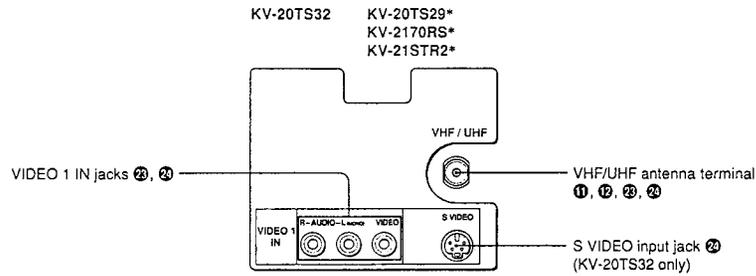

* These models are equipped with only one set of video input jacks.

Remote Commander

For details, see the pages indicated by the numbered black circles ●.

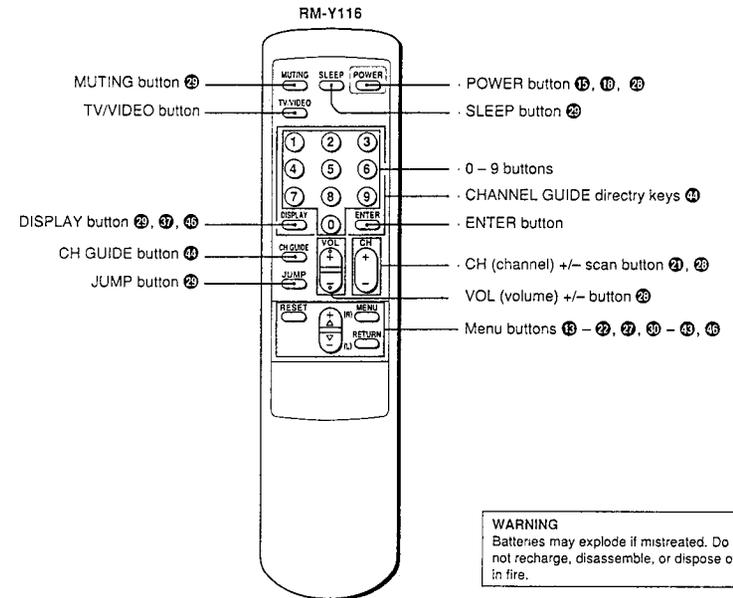

WARNING
Batteries may explode if mistreated. Do not recharge, disassemble, or dispose of in fire.

Installing batteries

1 Remove the battery compartment cover.

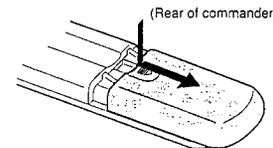

2 Insert two size AA (R6) batteries in correct polarity.

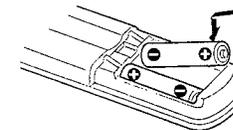

Battery life
With normal operation, batteries will last up to half a year. If the Remote Commander does not operate properly, the batteries might be exhausted. Replace both of them with new ones.

To avoid damage from possible battery leakage
Remove the batteries if you do not plan to use the Remote Commander for a fairly long time.

1-3. USING THE ON-SCREEN MENUS

The following flow chart shows the different levels of on-screen menus that you can use to make various adjustments and settings. See the indicated pages for instructions on using each feature.

For picture quality adjustment

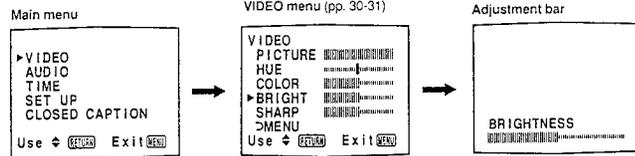

For sound quality adjustment

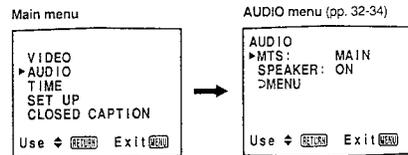

For time-related setting

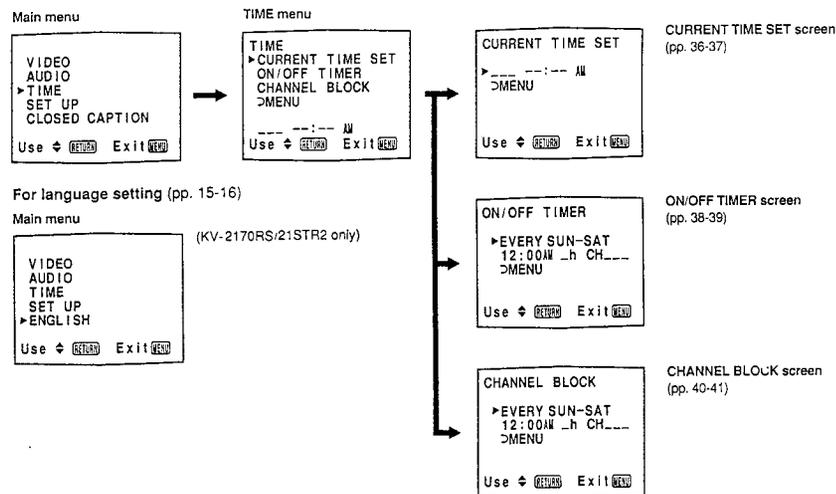

For language setting (pp. 15-16)

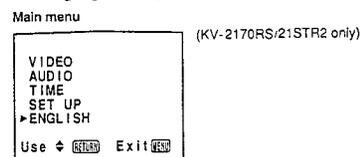

For presetting and other functions

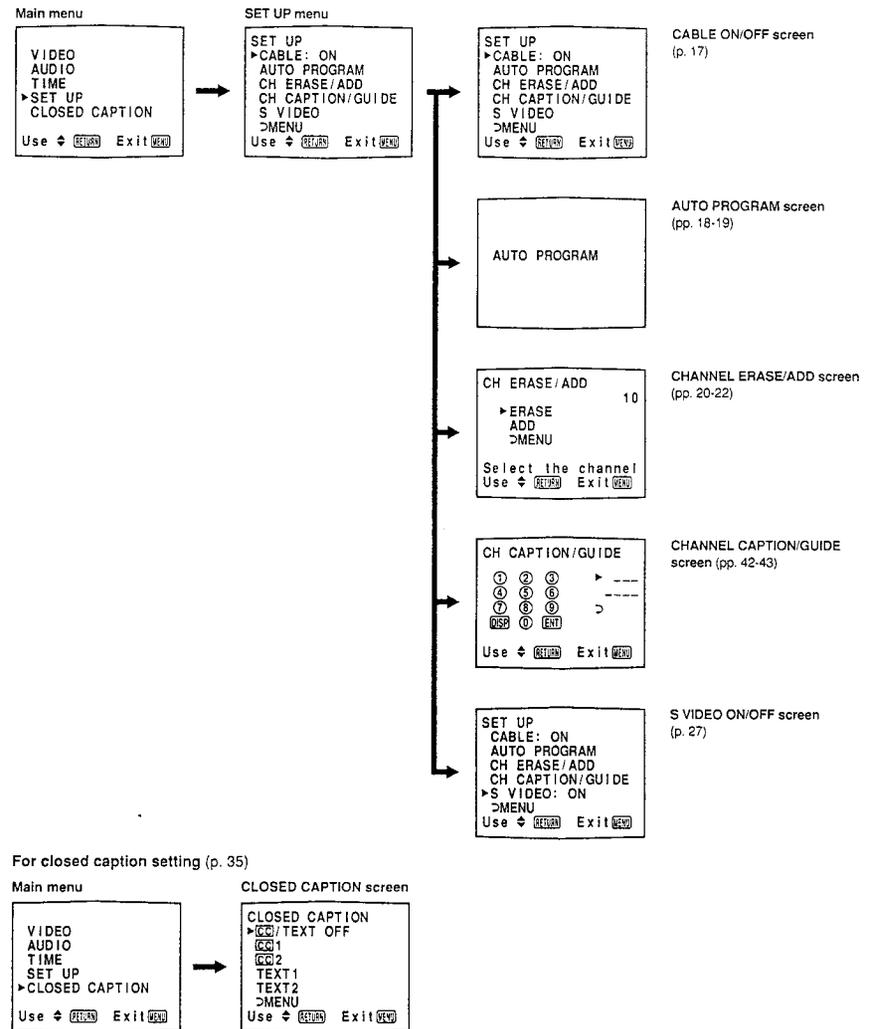

Navigating Through the Menus

To display the main menu
Press MENU.

To return to the previous menu
Press Δ+ or ▽- to select ◀ MENU.
Then press RETURN.

To return to the main menu
Repeat the above, until you reach the main menu.

To return to the normal screen
Press MENU on the Remote Commander.

Note

The menus disappear automatically if you do not press a button within 90 seconds.

Changing the Menu Language

(KV-2170RS/21STR2 only)

The menu language is factory-set to ENGLISH. Follow these instructions to change the menu language to Spanish or back to English.

1 Press POWER on the TV or the Remote Commander to turn the TV on.

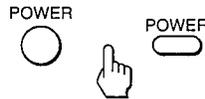

2 Press MENU.
The main menu appears.



3 Press the Δ+ or ▽- to select ENGLISH.
Then press RETURN.

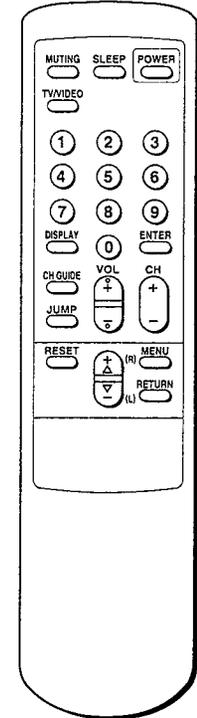
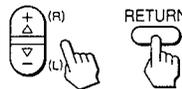

RM-Y116

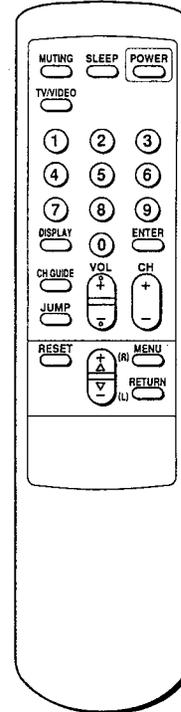

RM-Y116

To return to the normal screen
Press MENU.

4 Press Δ+ or ▽- to select the language.
Each time you press Δ+ or ▽-, the ESPAÑOL and ENGLISH menus appear.

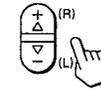

Note

Certain parts of the ESPAÑOL menu remain in English.

5 Press RETURN.
The language is selected.

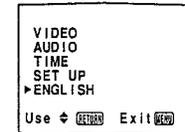

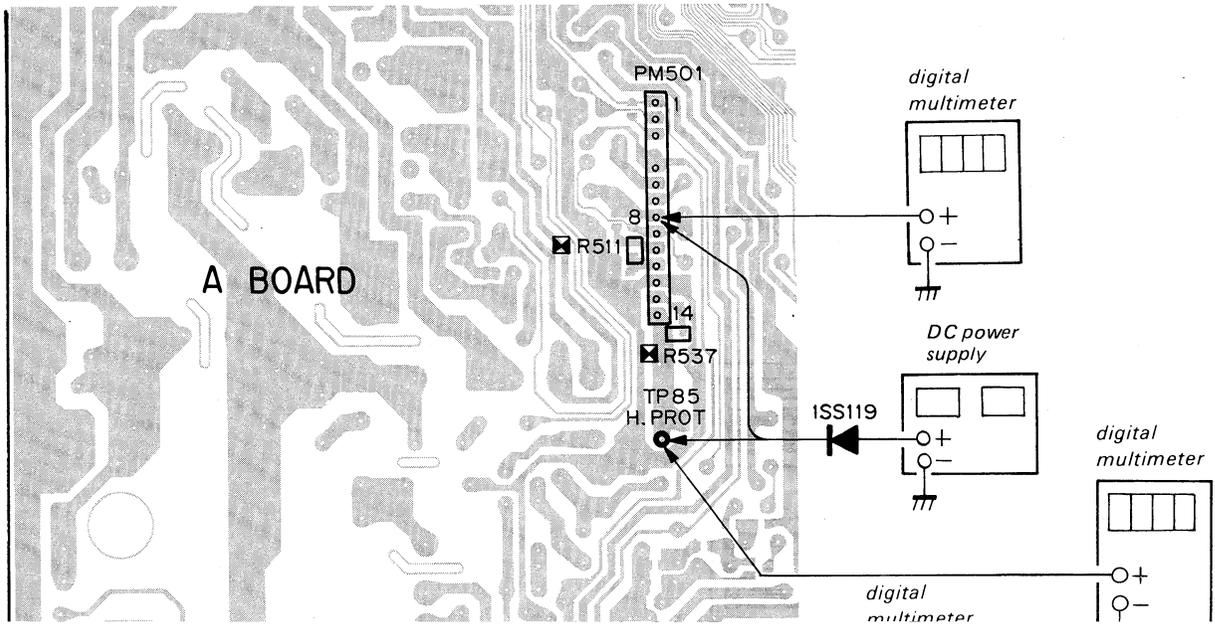
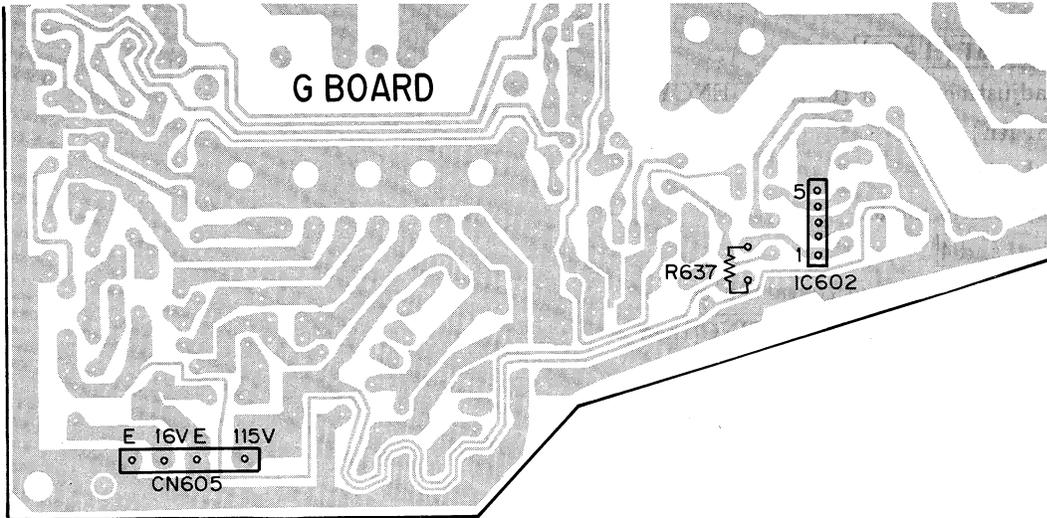

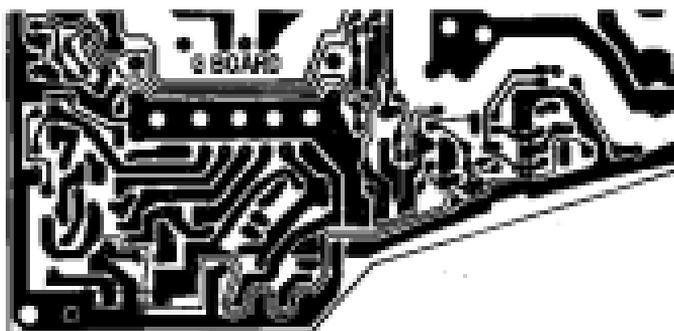

Sheet4U.com

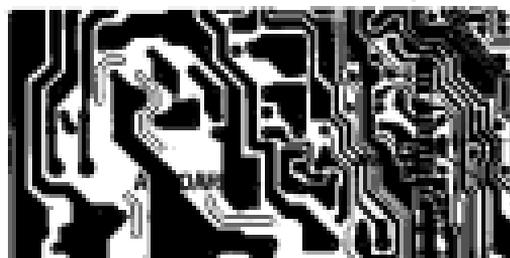

Sheet4U.com

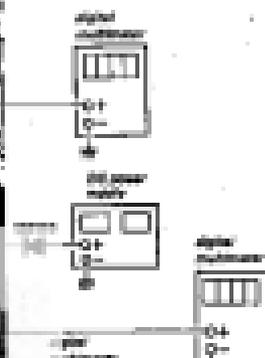

S [CLOSED CAPTION]

— S Board —

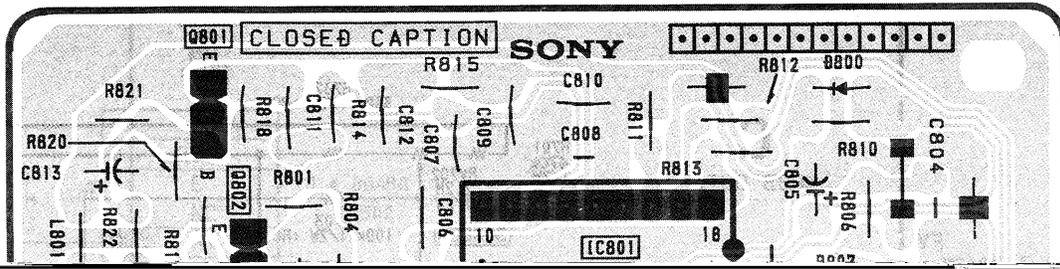

S

(GLASS) CAPTION

— B Board —



Sheet4U.com

taSheet4U.com

1-4. TURNING THE CABLE MODE ON OR OFF

All of the controls are on the Remote Commander.

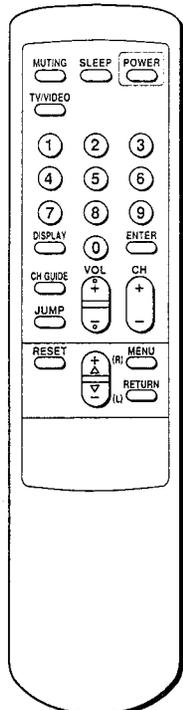

RM-Y116

To return to the normal screen
Press MENU.

If you have cable connected to your TV (p.11), follow the steps below to turn the cable connection on or off. CABLE is preset to ON when you use your TV for the first time. Turn CABLE to OFF to preset or watch VHF or UHF channels (pp. 18–22, 28).

- 1 Press MENU.
The main menu appears.



```

▶VIDEO
AUDIO
TIME
SET UP
CLOSED CAPTION
Use ⏪ [MENU] Exit [EXIT]
    
```

- 2 Press Δ+ or ▽- to select SET UP.



```

VIDEO
AUDIO
TIME
▶SET UP
CLOSED CAPTION
Use ⏪ [RETURN] Exit [EXIT]
    
```

Press RETURN.
The SET UP menu appears, and the cursor points to CABLE.



```

SET UP
▶CABLE: ON
AUTO PROGRAM
CH ERASE/ADD
CH CAPTION/GUIDE
S VIDEO
>MENU
Use ⏪ [RETURN] Exit [EXIT]
    
```

Note
If the CABLE display appears in black, the TV is in video mode and you cannot select CABLE. Press TV/VIDEO to change to TV mode.

- 3 Press RETURN again.



Press Δ+ or ▽- to select ON or OFF alternately.

```

SET UP
CABLE: OFF
AUTO PROGRAM
CH ERASE/ADD
CH CAPTION/GUIDE
S VIDEO
>MENU
Use ⏪ [RETURN] Exit [EXIT]
    
```



```

SET UP
CABLE: ON
AUTO PROGRAM
CH ERASE/ADD
CH CAPTION/GUIDE
S VIDEO
>MENU
Use ⏪ [RETURN] Exit [EXIT]
    
```

Press RETURN.
The setting is completed.

1-5. PRESETTING TV CHANNELS

By presetting TV channels to the TV, you can select channels by pressing CHANNEL +/- on the TV or CH +/- on the Remote Commander.

Presetting TV Channels Automatically

Note

Perform auto programming during the day rather than late at night, when some channels may not be broadcasting.

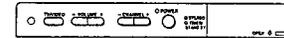

- 1 Press POWER on the TV or the Remote Commander to turn the TV on.

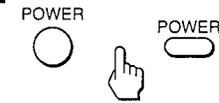

- 2 Turn the cable connection on or off to select the type of channel you want to preset, VHF/UHF or cable TV.
(Follow the steps in "Turning the Cable Mode On or Off," p. 17.)

- 3 Press MENU.
The main menu appears.



```

▶VIDEO
AUDIO
TIME
SET UP
CLOSED CAPTION
Use ⏪ [MENU] Exit [EXIT]
    
```

- 4 Press Δ+ or ▽- to select SET UP.

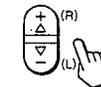

```

VIDEO
AUDIO
TIME
▶SET UP
CLOSED CAPTION
Use ⏪ [RETURN] Exit [EXIT]
    
```

Press RETURN.
The SET UP menu appears.



```

SET UP
▶CABLE: ON
AUTO PROGRAM
CH ERASE/ADD
CH CAPTION/GUIDE
S VIDEO
>MENU
Use ⏪ [RETURN] Exit [EXIT]
    
```

Note

If the AUTO PROGRAM display appears in black, the TV is in video mode and you cannot select AUTO PROGRAM. Press TV/VIDEO to change to TV mode.

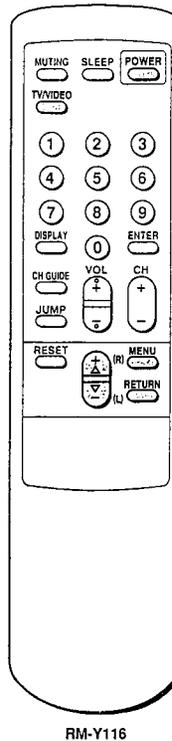

RM-Y116

5 Press Δ + or ∇ - to select AUTO PROGRAM.

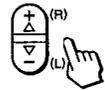

Press RETURN.

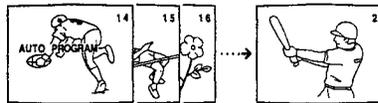

```

SET UP
CABLE: ON
▶AUTO PROGRAM
CH ERASE/ADD
CH CAPTION/GUIDE
S VIDEO
>MENU
Use  $\nabla$  RETURN Exit RETURN
    
```

Receivable channels for this TV
 VHF: 2 – 13
 UHF: 14 – 69
 Cable: 1 – 125

To select TV channels without presetting
 Press 0 – 9 and ENTER.

To return to the normal screen
 Press MENU.

To erase unnecessary channels, or to add channels that could not be preset automatically because their signal was too weak, follow the steps in "Erasing Unnecessary Channels – CHANNEL ERASE" (pp. 20–21) and "Presetting Only Desired Channels – CHANNEL ADD" (p. 22).

"AUTO PROGRAM" appears on the screen and receivable channels (other than the channels already preset) are preset in numerical sequence. The channels previously preset will not remain in the TV's memory. When no more channels can be found, the programming stops and the lowest numbered channel is displayed.

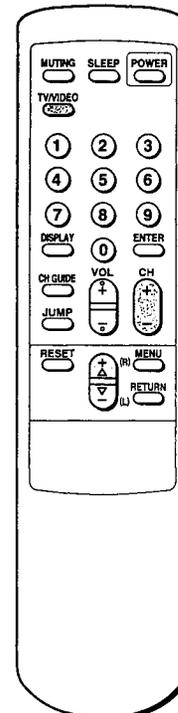

RM-Y116

Erasing Unnecessary Channels—CHANNEL ERASE

Use this feature to erase unnecessary TV channels, so that when you press CH +/-, the channel(s) are skipped.

1 Press MENU.
The main menu appears.



```

▶VIDEO
AUDIO
TIME
SET UP
CLOSED CAPTION
Use  $\nabla$  RETURN Exit RETURN
    
```

2 Press Δ + or ∇ - to select SET UP.

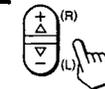

Press RETURN.
The SET UP menu appears.



```

VIDEO
AUDIO
TIME
▶SET UP
CLOSED CAPTION
Use  $\nabla$  RETURN Exit RETURN
    
```

```

SET UP
▶CABLE: ON
AUTO PROGRAM
CH ERASE/ADD
CH CAPTION/GUIDE
S VIDEO
>MENU
Use  $\nabla$  RETURN Exit RETURN
    
```

3 Press Δ + or ∇ - to select CH ERASE/ADD.

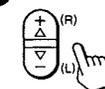

Press RETURN.
The CH ERASE/ADD screen appears, and the cursor points to ERASE.



```

SET UP
CABLE: ON
AUTO PROGRAM
▶CH ERASE/ADD
CH CAPTION/GUIDE
S VIDEO
>MENU
Use  $\nabla$  RETURN Exit RETURN
    
```

```

CH ERASE/ADD 10
▶ERASE
ADD
>MENU
Select the channel
Use  $\nabla$  RETURN Exit RETURN
    
```

Note

If the CHANNEL ERASE/ADD display appears in black, the TV is in video mode and you cannot select CHANNEL ERASE/ADD. Press TV/VIDEO to change to TV mode.

4 Press the CH +/- button to select the channel you want to erase.
For example, to erase channel 8, press CH + or - until 8 appears.

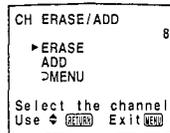
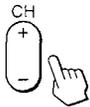

Press RETURN.

A "-" sign appears in front of the channel number display showing that the channel is erased from the channel scan memory.

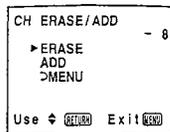

The next time you press the CH +/- buttons, channel 8 will be skipped.

To erase other channels
Repeat step 4.

To return to the normal screen
Press MENU.

Note

If you erase a VHF or UHF channel, the cable TV channel with the same number is also erased, and vice versa.

Cable TV channel chart*

Cable TV systems use letters or numbers to designate channels. To tune in a channel, refer to the chart below.

Number on this TV	Corresponding cable TV channel
1	A-8
5	A-7
6	A-6
14	A
15	B
16	C
17	D
18	E
19	F
20	G
21	H
22	I
23	J
24	K
25	L
26	M
27	N
28	O
29	P
30	Q
31	R
32	S
33	T
34	U
35	V
36	W
37	W+1
38	W+2
39	W+3
:	:
93	W+57
94	W+58
95	A-5
96	A-4
97	A-3
98	A-2
99	A-1
100	W+59
101	W+60
102	W+61
:	:
123	W+82
124	W+83
125	W+84

* This designation of cable TV channels conforms to the EIA/NCTA recommendation. Check with your local cable TV company for more complete information on the available channels.

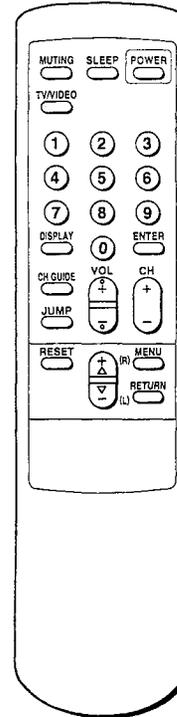

RM-Y116

To return to the normal screen
Press MENU.

Note

If you add a VHF or UHF channel, the cable TV channel with the same number is also added, and vice versa.

Presetting Only Desired Channels—CHANNEL ADD

Use this feature to add channels one by one to the channel scan memory.

1-3 (Follow steps 1-3 in "Erasing Unnecessary Channels - CHANNEL ERASE," p. 20.)

Note

If CH ERASE/ADD display appears in black, the TV is in video mode and you cannot select CH ERASE/ADD. Press TV/VIDEO to change to TV mode.

4 Press Δ+ or ∇- to select ADD.

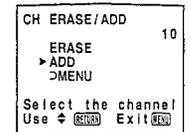

5 Press 0-9 and ENTER to select the channel you want to add. For example, to add channel 25, press 2, 5 and ENTER.

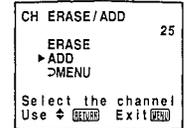
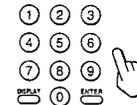

Press RETURN.

A "*" sign appears in front of the channel number display showing that the channel is added to the channel scan memory.

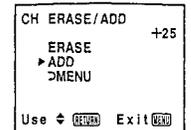

To add other channels
Repeat step 5.

1-6. CONNECTING OTHER EQUIPMENT

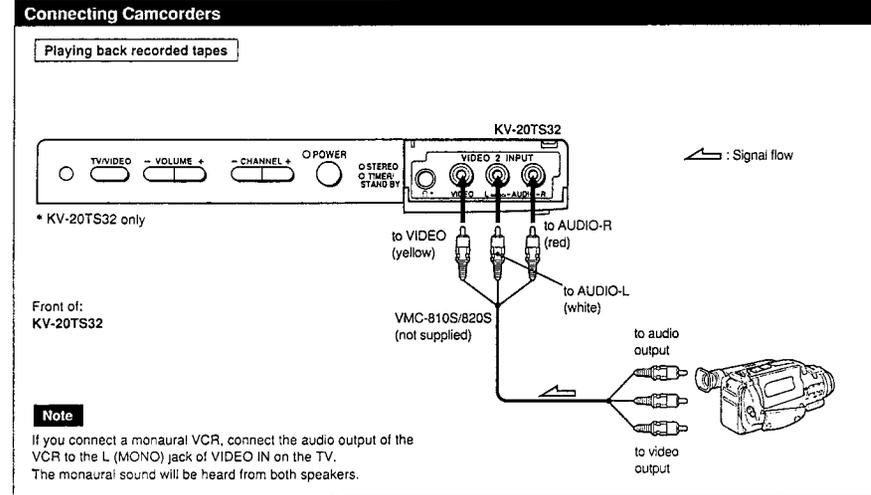
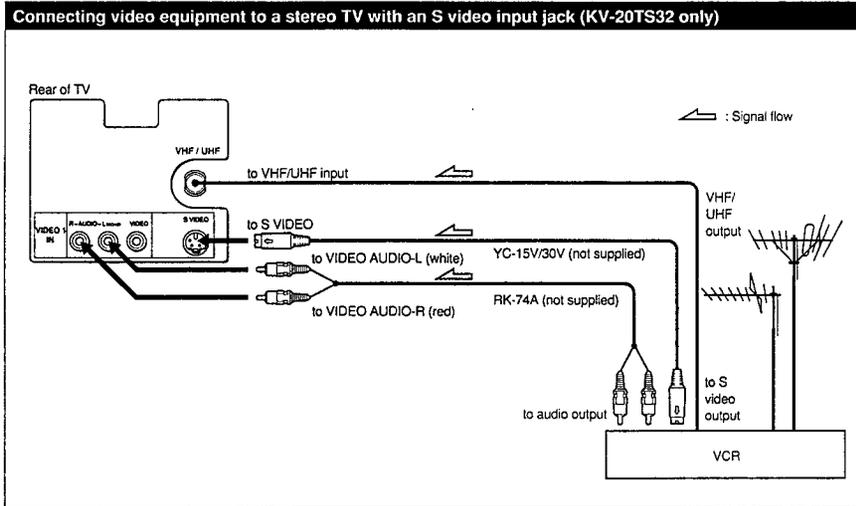

* KV-20TS32 only

Front of: KV-20TS32

Note

If you connect a monaural VCR, connect the audio output of the VCR to the L (MONO) jack of VIDEO IN on the TV. The monaural sound will be heard from both speakers.

Preparing for use

- 1 Turn on the TV.
- 2 Press the TV/VIDEO button on the TV or on the Remote Commander so that "VIDEO" appears on the screen.

When you cannot obtain a clear picture and/or sound
 Make sure that the TV/VTR on the VCR is set to TV.
 Reselect the channel you want to view with the controls on the TV or the Remote Commander.

To return to TV mode
 Press the TV/VIDEO button on the TV or Remote Commander so that a channel number appears on the screen.

About S video input

Video input and output signals can be separated into Y (luminance or brightness) and C (chroma or color) signals. Usually these two signals are combined in a VCR and sent as one signal to a TV. Separation of the Y and C signals prevents them from interfering with one another, thereby improving picture (especially color) quality. This TV is equipped with an S video input jack through which these separated signals can be input directly. This way you can connect your S video-equipped VCR separately from a non-S video VCR.

Notes

- For operating instructions, refer to the instruction manual furnished with the VCR.
- If the picture or sound is affected, move the VCR away from the TV.
- If S VIDEO is set to OFF, you cannot watch VCR playback pictures from the S VIDEO input. To set S VIDEO to ON, see "Watching a Video with Your S Video-Equipped VCR," p. 27.

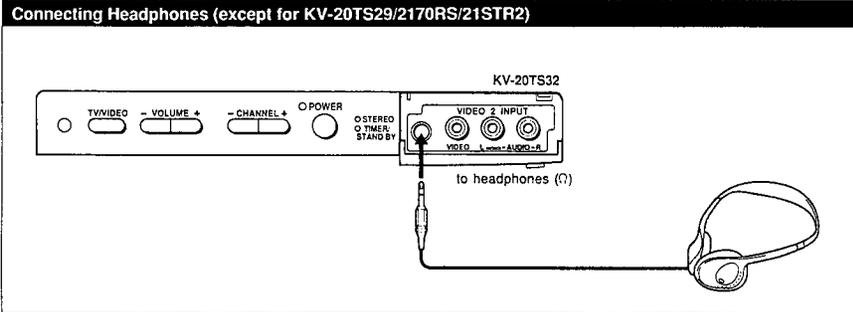

Notes

- To prevent hearing damage due to sudden or prolonged excessive volume, do not raise the headphones volume too high while listening.
- If your TV is a monaural TV, the monaural sound will be heard from both headphones.

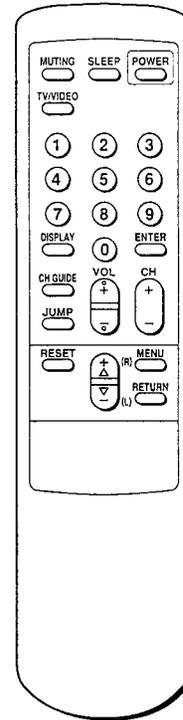

RM-Y116

To return to the normal screen
Press MENU.

Note

If you set S VIDEO to ON, the TV automatically receives S video signals whenever a VCR with S video is connected.

Watching a Video with Your S Video-Equipped VCR

(KV-20TS32 only)

Use this feature to set S VIDEO to ON or OFF depending on the kind of video equipment you have connected to the TV.
For instructions on connecting video equipment, see p. 24.

Note

If the TV is in TV or VIDEO 2 mode, the S VIDEO display appears in black and cannot be selected.
Press TV/VIDEO to change to VIDEO 1 mode.

1 Press MENU.
The main menu appears.

Use Δ (RETURN) Exit (EXIT)

2 Press Δ + or ∇ - to select SET UP.

Use Δ (RETURN) Exit (EXIT)

Press RETURN.
The SET UP menu appears.

Use Δ (RETURN) Exit (EXIT)

3 Press Δ + or ∇ - to select S VIDEO.
Then press RETURN.

Use Δ (RETURN) Exit (EXIT)

Press Δ + or ∇ - to select ON or OFF alternately.

Use Δ (RETURN) Exit (EXIT)

Press RETURN.
The setting is completed.

1-7. WATCHING TV PROGRAMS

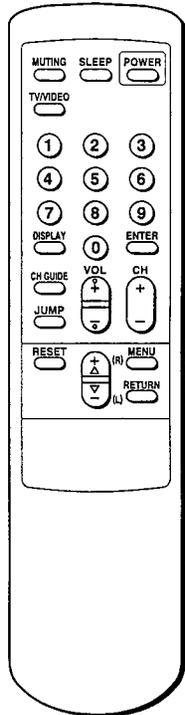
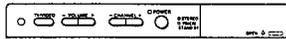

RM-Y116

1 Press POWER on the TV or the Remote Commander to turn the TV on.

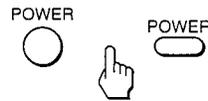

The TIMER/STAND BY indicator blinks until the picture appears on the screen.

2 Turn the cable mode on or off to select the type of channel you want to watch, VHF/UHF or cable TV.
(Follow the steps in "Turning the Cable Mode On or Off," p. 17.)

If "VIDEO" or "S VIDEO" is displayed on the screen, press the TV/VIDEO button on the TV or on the Remote Commander so that the channel number appears.

3 Select a channel in one of the following two ways:

To scan the preset channels* in numerical sequence
Press CH +/-.



* For more information on presetting channels, see pp. 18 - 22.

To select a channel directly
Press 0 - 9 and ENTER.
For example, to select channel 14, press 1, 4 and ENTER.

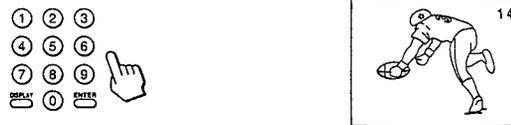

4 Press VOL +/- to adjust the volume.

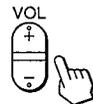

The display will disappear automatically after 3 seconds.



Press + to increase the volume.
Press - to decrease the volume.

To turn off the TV
Press POWER on the TV or the Remote Commander again.

1-8. USING CONVENIENT FEATURES

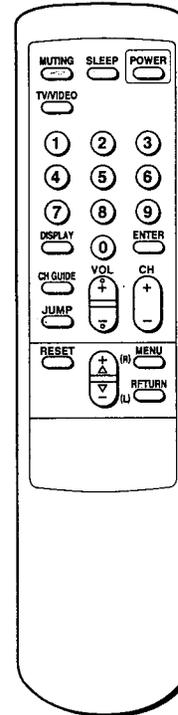

RM-Y116

Muting the Sound — MUTING

Press MUTING
The display "MUTING" will appear on the screen.



To restore the sound
Press MUTING again, or press VOL +.

Keeping the Displays On-Screen — DISPLAY

To display the channel
Press DISPLAY.
All the existing displays appear: channel number, channel caption (if set), MTS mode (SAP only) and the current time ("AM" or "PM" disappears after about three seconds).



To cancel the display
Press DISPLAY again.
The channel display will disappear.

Setting the Sleep Timer — SLEEP

The sleep timer turns off the TV automatically after the amount of time you select.

Press SLEEP.
Each time you press SLEEP, the time increments 30, 60, 90 and OFF mode appear in sequence.



SLEEP 30
SLEEP 60
SLEEP 90
SLEEP OFF

The SLEEP display appears about one minute before the TV turns off.

To cancel the setting
Press SLEEP until OFF mode appears.
The "SLEEP OFF" display appears for about three seconds.
OR
Turn the TV off.
The sleep timer setting is cancelled.

Switching Quickly Between Two Channels — JUMP

Press JUMP once to recall the channel you were watching previously. Press JUMP again to switch back. Use this feature to keep track of two programs alternately.



1-9. ADJUSTING PICTURE AND SOUND QUALITY

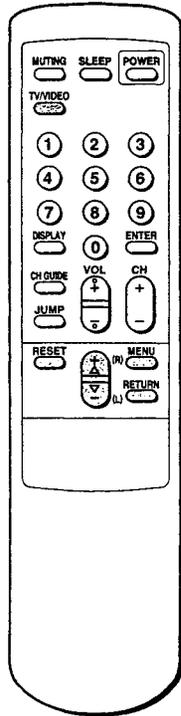

RM-Y116

Adjusting Picture Quality

You can adjust the picture for each input mode (TV, VIDEO 1, VIDEO 2) by pressing TV/VIDEO to select the input mode before making the adjustments. These adjustments are retained in memory even when you turn off the TV until you change the adjustments again.

- 1 Press MENU.
The main menu appears, and the cursor points to VIDEO.

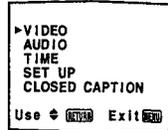

- 2 Press RETURN.
The VIDEO menu appears.

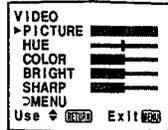

- 3 Press $\Delta+$ or $\nabla-$ to select the item you want to adjust.
For example, to adjust the picture brightness, select BRIGHT.

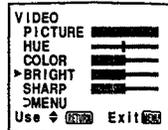

Press RETURN.
The adjustment bar appears.



- 4 Press $\Delta+$ or $\nabla-$ to make the adjustment.



Press RETURN.
The new setting appears in the VIDEO menu.



To adjust other items
Repeat steps 3 - 4.

	Press $\nabla-$ to:	Press $\Delta+$ to:
PICTURE	decrease picture contrast with soft color	increase picture contrast with vivid color
HUE	make skin tones become purplish	make skin tones become greenish
COLOR	decrease color intensity	increase color intensity
BRIGHTNESS	darken the picture	brighten the picture
SHARPNESS	soften the picture	sharpen the picture



To return to the normal screen
Press MENU.

To restore the factory (mid-level) setting
Go to the VIDEO menu and press RESET.
All the settings except for PICTURE will be restored to the mid-level setting.

Note

The menus and adjustment bars will disappear automatically after 90 seconds if you do not press any other buttons during that time.

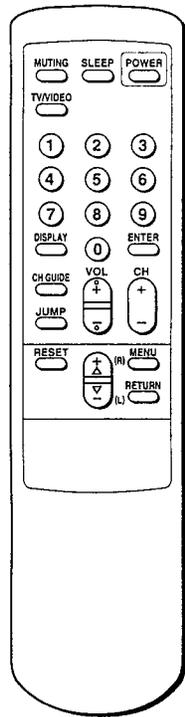

RM-Y116

Receiving Multichannel TV Sound Programs — MTS

1 Press MENU.
The main menu appears.

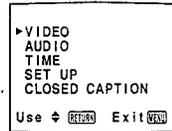

2 Press $\Delta+$ or $\nabla-$ to select AUDIO.

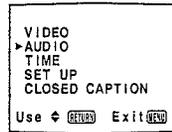

Press RETURN.
The AUDIO menu appears, and the cursor points to MTS.

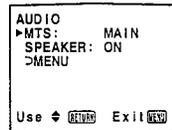

3 Press RETURN.



4 Press $\Delta+$ or $\nabla-$ to select the mode you want.
Each time you press $\Delta+$ or $\nabla-$, "MAIN", "SAP" and "MONO" appear in sequence.

Select the MAIN mode to listen to STEREO sound.
The STEREO indicator on the TV lights up whenever a stereo broadcast is received.

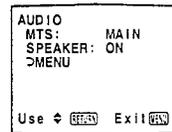

To return to the normal screen
Press MENU.

Select the SAP mode to listen to Second Audio Programs.

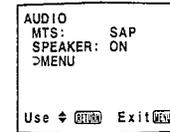

Note

During SAP mode, the sound of non-SAP programs will be muted.

Select the MONO mode to eliminate excessive noise during stereo broadcasts, caused by a weak signal.



Press RETURN
The mode is selected.



1-10. USING CLOSED CAPTION (U.S.A. models only)

Turning the Speaker On or Off

1-2 (Follow steps 1-2 in "Receiving Multichannel TV Sound Programs — MTS," p. 32.)

3 Press Δ+ or ∇- to select SPEAKER. Then press RETURN.

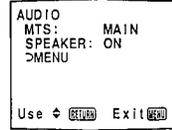

4 Press Δ+ or ∇- to select ON or OFF alternately.

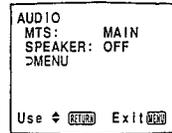
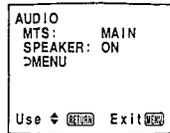

Press RETURN.
The setting is completed.

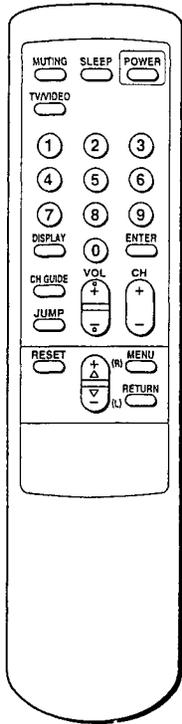
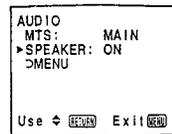

RM-Y116

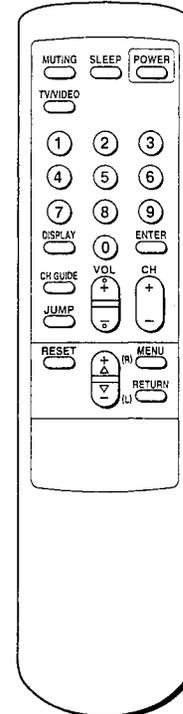

RM-Y116

To return to the normal screen
Press MENU.

1 Press MENU.
The main menu appears.

2 Press Δ+ or ∇- to select CLOSED CAPTION. Then press RETURN.
The CLOSED CAPTION screen appears.

3 Press Δ+ or ∇- to select closed caption mode.

Select CC1 or CC2 to view Captions.
A Caption is a printed version of the dialogue or sound effects of a program. (The mode should be set to CC1 for most programs.)

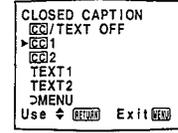

Select TEXT1 or TEXT2 to view Text.
Text is information that is presented using the half to full television screen.
It is usually not related to the program.

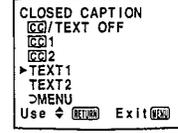

Select CC/TEXT OFF if you do not want to use the CLOSED CAPTION mode.

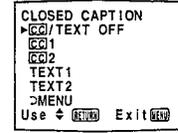

Press RETURN.
The Setting is completed.



1-11. USING THE TIMER-ACTIVATED FUNCTIONS

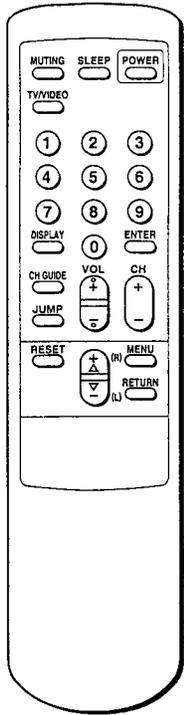

RM-Y116

Setting the Clock – CURRENT TIME SET

Follow these instructions to set the current time. The correct time must be set in order to use the other timer-activated functions (ON/OFF TIMER, CHANNEL BLOCK).

EXAMPLE: Set the time to 3:15 PM, Monday.

1 Press MENU.
The main menu appears.

▶ VIDEO
AUDIO
TIME
SET UP
CLOSED CAPTION

Use ◀ RETURN Exit ▶

2 Press Δ+ or ∇- to select TIME.

VIDEO
AUDIO
▶ TIME
SET UP
CLOSED CAPTION

Use ◀ RETURN Exit ▶

Press RETURN.
The TIME menu appears, and the cursor points to CURRENT TIME SET.

TIME
▶ CURRENT TIME SET
ON/OFF TIMER
CHANNEL BLOCK
MENU

Use ◀ RETURN Exit ▶

3 Press RETURN.
The CURRENT TIME SET screen appears.

CURRENT TIME SET
▶ ---:--:-- AM
MENU

Use ◀ RETURN Exit ▶

4 Press RETURN again.
"Set the day." appears on the screen.

CURRENT TIME SET
SUN 12:00 AM
MENU

Set the day.
Use ◀ RETURN Exit ▶

5 Press Δ+ or ∇- to set the day.
Each time you press Δ+ or ∇-, the day changes consecutively.

Press RETURN.
"Set the time." appears on the screen.

CURRENT TIME SET
MON 12:00 AM
MENU

Set the time.
Use ◀ RETURN Exit ▶

6 Press Δ+ or ∇- to set the hour.
Each time you press Δ+ or ∇-, the hour changes starting with "12:00 AM."

Press RETURN.

CURRENT TIME SET
MON 3:00 PM
MENU

Set the time.
Use ◀ RETURN Exit ▶

7 Press Δ+ or ∇- to set the minutes.
Each time you press Δ+ or ∇-, the minutes change in sequence.

Press RETURN.
The setting is completed, and the clock starts.

CURRENT TIME SET
▶ MON 3:15 PM
MENU

Use ◀ RETURN Exit ▶

To reset the time
Press RESET while in the CURRENT TIME screen, and repeat steps 4-7.

To display the time
Press DISPLAY.

To return to the normal screen
Press MENU.

- Notes**
- The internal clock of this TV operates on a 12-hour cycle. If a 24-hour cycle number (for instance, 13:00) is entered, it will be cleared when you press RETURN.

12:00 AM stands for midnight.
12:00 PM stands for noon.

- All the settings including CURRENT TIME SET will be erased if you unplug the TV or a power failure occurs. Reset the current time by following steps 1-7.

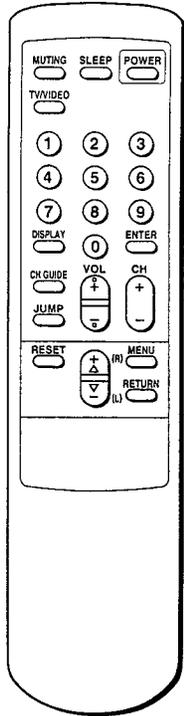

Setting the ON/OFF TIMER

With this function you can set your favorite program to appear on the screen at the time that you set.

EXAMPLE: Set the timer to turn on the TV every Monday through Friday at 3:15 PM for 2 hours, on channel 21.

1 Press MENU.
The main menu appears.



▶VIDEO
AUDIO
TIME
SET UP
CLOSED CAPTION
Use \blacktriangleleft RETURN Exit \blacktriangleright

2 Press Δ + or ∇ - to select TIME.
Then press RETURN.
The TIME menu appears.

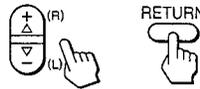

▶TIME
▶CURRENT TIME SET
ON/OFF TIMER
CHANNEL BLOCK
>MENU
MON 3:15 PM
Use \blacktriangleleft RETURN Exit \blacktriangleright

3 Press Δ + or ∇ - to select ON/OFF TIMER.
Then press RETURN.
The ON/OFF TIMER screen appears.

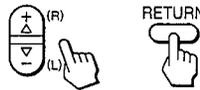

ON/OFF TIMER
▶EVERY SUN-SAT
12:00AM -h CH---
>MENU
Use \blacktriangleleft RETURN Exit \blacktriangleright

Note
If the ON/OFF TIMER display appears in black, the current time has not been set and you cannot select ON/OFF TIMER. To set the clock, see "Setting the Clock - CURRENT TIME SET," pp. 36-37.

4 Press RETURN again.
"Set the day." appears on the screen.



ON/OFF TIMER
EVERY SUN-SAT
12:00AM -h CH---
>MENU
Set the day.
Use \blacktriangleleft RETURN Exit \blacktriangleright

5 Press Δ + or ∇ - to set the day.
Each time you press Δ + or ∇ -, the days of the week change as shown in Fig. 1.
Then press RETURN.
"Set the time." appears on the screen.

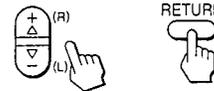

ON/OFF TIMER
EVERY MON-FRY
12:00AM -h CH---
>MENU
Set the time.
Use \blacktriangleleft RETURN Exit \blacktriangleright

6 Press Δ + or ∇ - to set the hour that you want the TIMER to start.
Each time you press Δ + or ∇ -, the hour changes in sequence.
Then press RETURN.



ON/OFF TIMER
EVERY MON-FRY
3:00AM -h CH---
>MENU
Set the time.
Use \blacktriangleleft RETURN Exit \blacktriangleright

7 Press Δ + or ∇ - to set the minutes.
Each time you press Δ + or ∇ -, the minutes change in sequence.
Then press RETURN.
"Set the duration." appears on the screen.



ON/OFF TIMER
EVERY MON-FRY
3:15PM -h CH---
>MENU
Set the duration.
Use \blacktriangleleft RETURN Exit \blacktriangleright

8 Press Δ + or ∇ - to set the duration of time.
Each time you press Δ + or ∇ -, the duration changes from "1" to "6" in sequence.
Then press RETURN.
"Select the channel" appears on the screen.

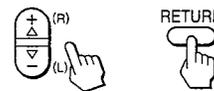

ON/OFF TIMER
EVERY MON-FRY
3:15PM 2h CH---
>MENU
Select the channel
Use \blacktriangleleft RETURN Exit \blacktriangleright

9 Press Δ + or ∇ - to set the channel that you want the TV to tune in.
Each time you press Δ + or ∇ -, the channel number changes from 1 to 125 in sequence.

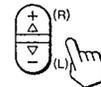

ON/OFF TIMER
EVERY MON-FRY
3:15PM 2h CH 21
>MENU
Select the channel
Use \blacktriangleleft RETURN Exit \blacktriangleright

Press RETURN.
The setting is completed, and the TIMER indicator on the front of the TV lights up.



ON/OFF TIMER
▶EVERY MON-FRY
3:15PM 2h CH 21
>MENU
Use \blacktriangleleft RETURN Exit \blacktriangleright

To clear the ON/OFF TIMER setting
Press RESET while in the ON/OFF TIMER screen.

To return to the normal screen
Press MENU.

Notes

- While the TIMER is set, the TIMER indicator on the TV is on.
- One minute before the timer goes off, the "TV will turn off" display will appear on the screen.
- If you have not set the clock correctly, the ON/OFF TIMER will not operate at the proper time. To set the clock, see "Setting the Clock-CURRENT TIME SET," pp. 36-37.
- All the settings including ON/OFF TIMER will be erased if you unplug the TV or a power failure occurs. Reset the TIMER by following steps 1-9.

Fig. 1
Selecting the day(s) of the week
When you press Δ +, the days of the week appear in the following order.

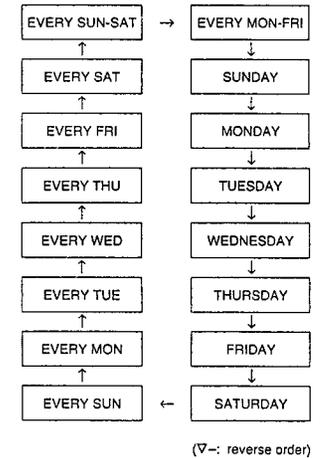

(∇ -: reverse order)

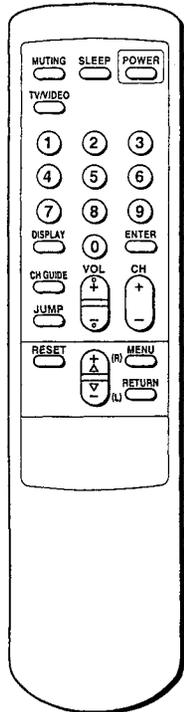

RM-Y116

Setting CHANNEL BLOCK

Use this function to block a channel from appearing on the screen during the time you specify. You can use this function to prevent children from watching undesirable programs.

EXAMPLE: Set CHANNEL BLOCK every Sunday at 8:45 PM for one hour, on channel 38.

1 Press MENU.
The main menu appears.

▶ VIDEO
AUDIO
TIME
SET UP
CLOSED CAPTION

Use \leftarrow [RETURN] Exit [EXIT]

2 Press Δ + or ∇ - to select TIME.
Then press RETURN.

TIME
▶ CURRENT TIME SET
ON/OFF TIMER
CHANNEL BLOCK
>MENU

MON 3:15 PM

Use \leftarrow [RETURN] Exit [EXIT]

3 Press Δ + or ∇ - to select CHANNEL BLOCK.
Then press RETURN.

CHANNEL BLOCK
▶ EVERY SUN-SAT
12:00AM -h CH---
>MENU

Use \leftarrow [RETURN] Exit [EXIT]

Note
If the CHANNEL BLOCK display appears in black, the current time has not been set and you cannot select CHANNEL BLOCK. To set the clock, see "Setting the Clock - CURRENT TIME SET," pp. 36-37.

4 Press RETURN again.
"Set the day," appears on the screen.

CHANNEL BLOCK
EVERY SUN-SAT
12:00AM -h CH---
>MENU

Set the day.
Use \leftarrow [RETURN] Exit [EXIT]

5 Press Δ + or ∇ - to set the day.
Each time you press Δ + or ∇ -, the days of the week change as shown in Fig. 1. (See p.39.)
Then press RETURN.
"Set the time," appears on the screen.

CHANNEL BLOCK
SUNDAY
12:00AM -h CH---
>MENU

Set the time.
Use \leftarrow [RETURN] Exit [EXIT]

6 Press Δ + or ∇ - to set the hour.
Each time you press Δ + or ∇ -, the hour changes in sequence.
Then press RETURN.

CHANNEL BLOCK
SUNDAY
8:00PM -h CH---
>MENU

Set the time.
Use \leftarrow [RETURN] Exit [EXIT]

7 Press Δ + or ∇ - to set the minutes.
Each time you press Δ + or ∇ -, the minutes change in sequence.
Then press RETURN.
"Set the duration," appears on the screen.

CHANNEL BLOCK
SUNDAY
8:45PM -h CH---
>MENU

Set the duration.
Use \leftarrow [RETURN] Exit [EXIT]

8 Press Δ + or ∇ - to set the duration of time that you want the TV remain blocked.
Each time you press Δ + or ∇ -, the duration changes from "1" to "6" in sequence.
Then press RETURN.
"Select the channel" appears on the screen.

CHANNEL BLOCK
SUNDAY
8:45PM 1h CH---
>MENU

Select the channel
Use \leftarrow [RETURN] Exit [EXIT]

9 Press Δ + or ∇ - to set the channel that you want to block.
Each time you press Δ + or ∇ -, the channel number changes from 1 to 125 in sequence.

CHANNEL BLOCK
SUNDAY
8:45PM 1h CH 38
>MENU

Select the channel
Use \leftarrow [RETURN] Exit [EXIT]

Press RETURN.
The setting is completed.

CHANNEL BLOCK
▶ SUNDAY
8:45PM 1h CH 38
>MENU

Use \leftarrow [RETURN] Exit [EXIT]

If you select a channel which has been blocked, the message of "BLOCKED" appears.



To clear the BLOCK setting
Press RESET while in the CHANNEL BLOCK screen.

To return to the normal screen
Press MENU.

- Notes**
- If you set a new CHANNEL BLOCK by following steps 1-9, the original setting will be erased.
 - If you have not set the clock correctly, CHANNEL BLOCK will not operate at the proper time. To set the current time, see "Setting the Clock - CURRENT TIME SET," pp. 36-37.

1-12. CUSTOMIZING THE SCREEN DISPLAY

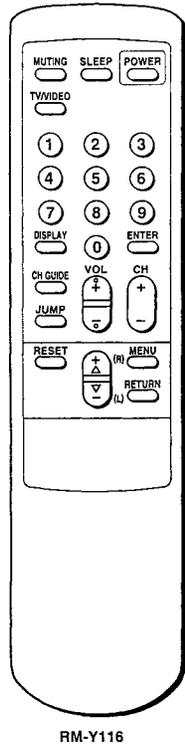

RM-Y116

Setting Channel Captions – CH CAPTION

Use this feature to caption up to 12 channel number displays with the matching channel call letters.

EXAMPLE: Caption channel 20 with ESPN at the caption position number 4.

- Press MENU.
The main menu appears.



- Press Δ or ∇ to select SET UP.
Then press RETURN.
The SET UP menu appears.

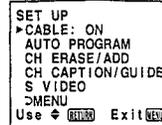

- Press Δ or ∇ to select CH CAPTION/GUIDE.
Then press RETURN.
The CH CAPTION/GUIDE screen appears.

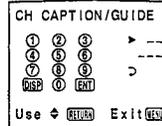

Note

If the CH CAPTION/GUIDE display appears in black, the TV is in video mode and you cannot select CH CAPTION/GUIDE. Press TV/VIDEO to change to TV mode.

- Press RETURN again.
"Select a position." appears on the screen.

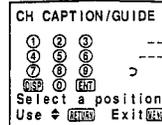

- Press Δ or ∇ to select a caption position number.
Each time you press Δ or ∇ , the caption position number is marked in sequence.
Then press RETURN.
"Select the channel" appears on the screen.

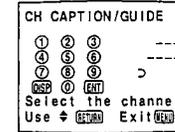

To erase unneeded captions
Call the caption setting screen by following steps 1 - 5. and press RESET.

To return to the normal screen
Press MENU.

- Press Δ or ∇ to select the channel you want to caption.
Each time you press Δ or ∇ , the channel number changes from 1 to 125.
Then press RETURN.
"Select the letter." appears on the screen.

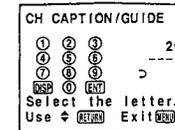

- Press Δ or ∇ to select the first letter.
Each time you press Δ or ∇ , "0-9," "A-Z," "&," "!", "-", and "_" (blank space) appear in sequence.
Then press RETURN.

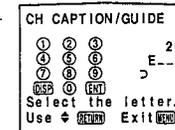

- Repeat step 7 to select each remaining letter.
(For a 3-letter caption, leave a space by pressing RETURN only.)

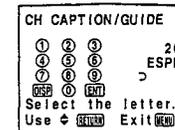

- Press RETURN.
The setting is completed.

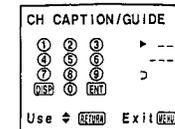

To caption other channels
Repeat steps 4-9.

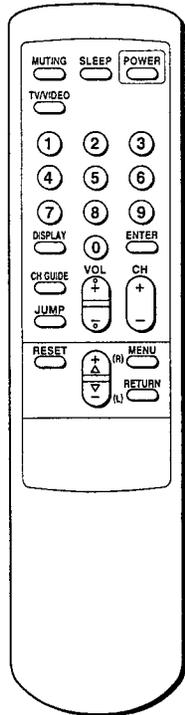

RM-Y116

Viewing the Captioned Channels – CHANNEL GUIDE

Use this feature to display the captions you set, and to select a channel directory for viewing.

- 1 Press CH GUIDE.
A directory appears, corresponding to the directory keys on the Remote Commander.

CH GUIDE



To cancel the CHANNEL GUIDE screen
Press CH GUIDE again.

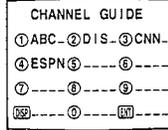

- 2 Press the directory key of the channel you want to watch.

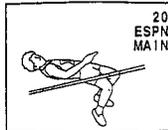

1-13. TROUBLESHOOTING

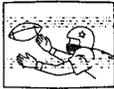
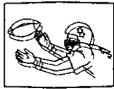
Symptom	Possible causes and remedies
Poor or no picture (screen not lit), good sound	<ul style="list-style-type: none"> Adjust PICTURE. Adjust BRIGHTNESS. Check antenna/cable connections.
Good picture, no sound	<ul style="list-style-type: none"> Press VOLUME + on the TV or VOL + on the Remote Commander. Press MUTING on the Remote Commander. Check that the MTS setting is set correctly. Check that the TV/VIDEO button is set correctly. Check that "SPEAKER ON" is set.
Good picture, no sound from the cordless headphones	<ul style="list-style-type: none"> Is the battery used up? Is the cordless headphones power turned on? Adjust the cordless headphones volume control. Make sure HEADPHONES is set to ON.
Good picture, noisy sound from the cordless headphones	<ul style="list-style-type: none"> Is the battery used up? Remove obstacles between the infrared emitter and the cordless headphones. Is the infrared detector covered by your hands, hair, etc? Adjust the direction and the position of the infrared emitter.
No picture (screen not lit), no sound	<ul style="list-style-type: none"> Is POWER switched on? Plug the unit into a wall outlet. Check that the TV/VIDEO button is set correctly. Make sure S VIDEO is set to on.
No color	<ul style="list-style-type: none"> Is it a color program? Adjust COLOR.
Snow and noise only	<ul style="list-style-type: none"> Is it an active or the correct channel? Check the CABLE setting. Check antenna/cable connections.
 Dotted lines or stripes	This is often caused by local interference. (e.g. cars, neon signs, hairdryers etc.) Adjust the antenna for minimum interference.
 Double images or ghosts	Reflections from nearby mountains or buildings often cause this problem. A highly directional outdoor antenna or a CATV cable may improve the picture.
Try another channel. It could be station trouble.	

If the problem persists, contact your nearest service facility.

SECTION 2 DISASSEMBLY

2-1. REAR COVER REMOVAL

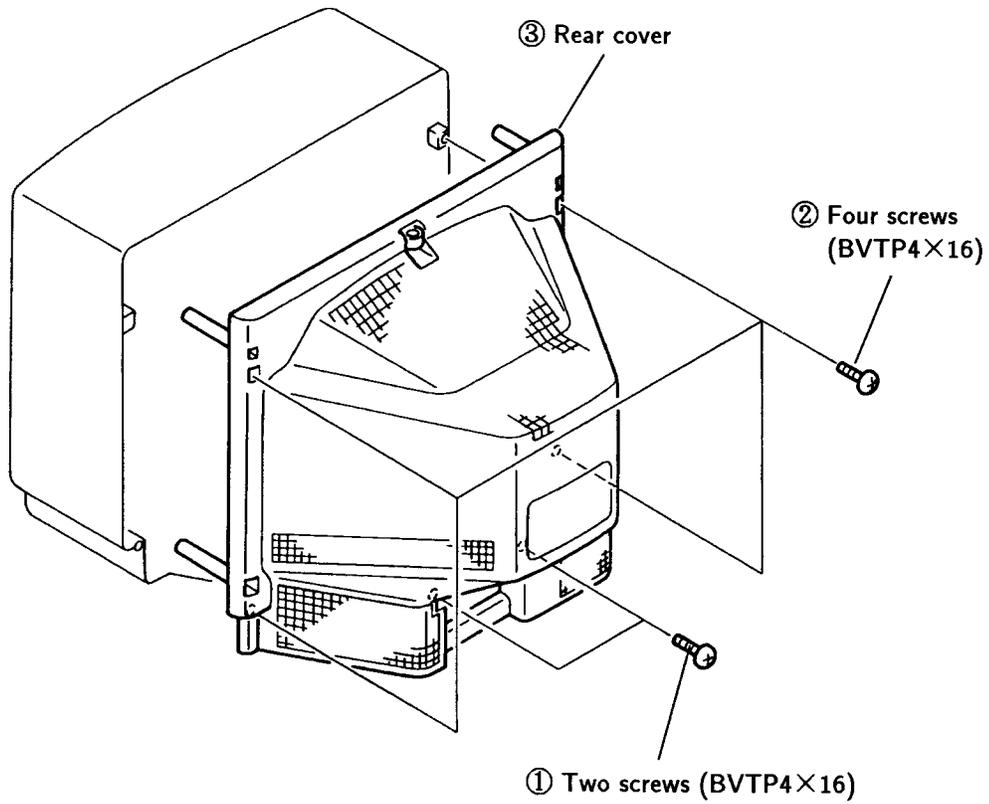

2-2. SERVICE POSITION

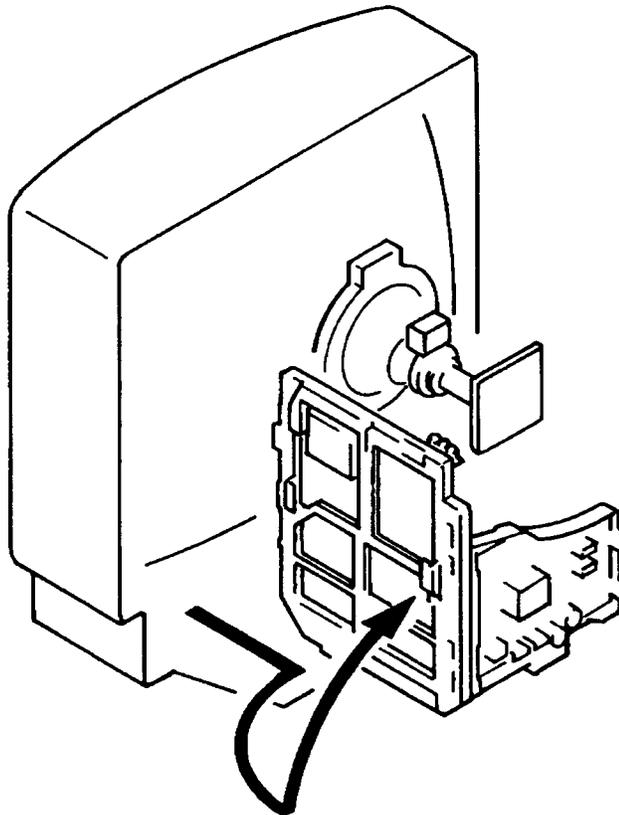

2-3. PICTURE TUBE REMOVAL

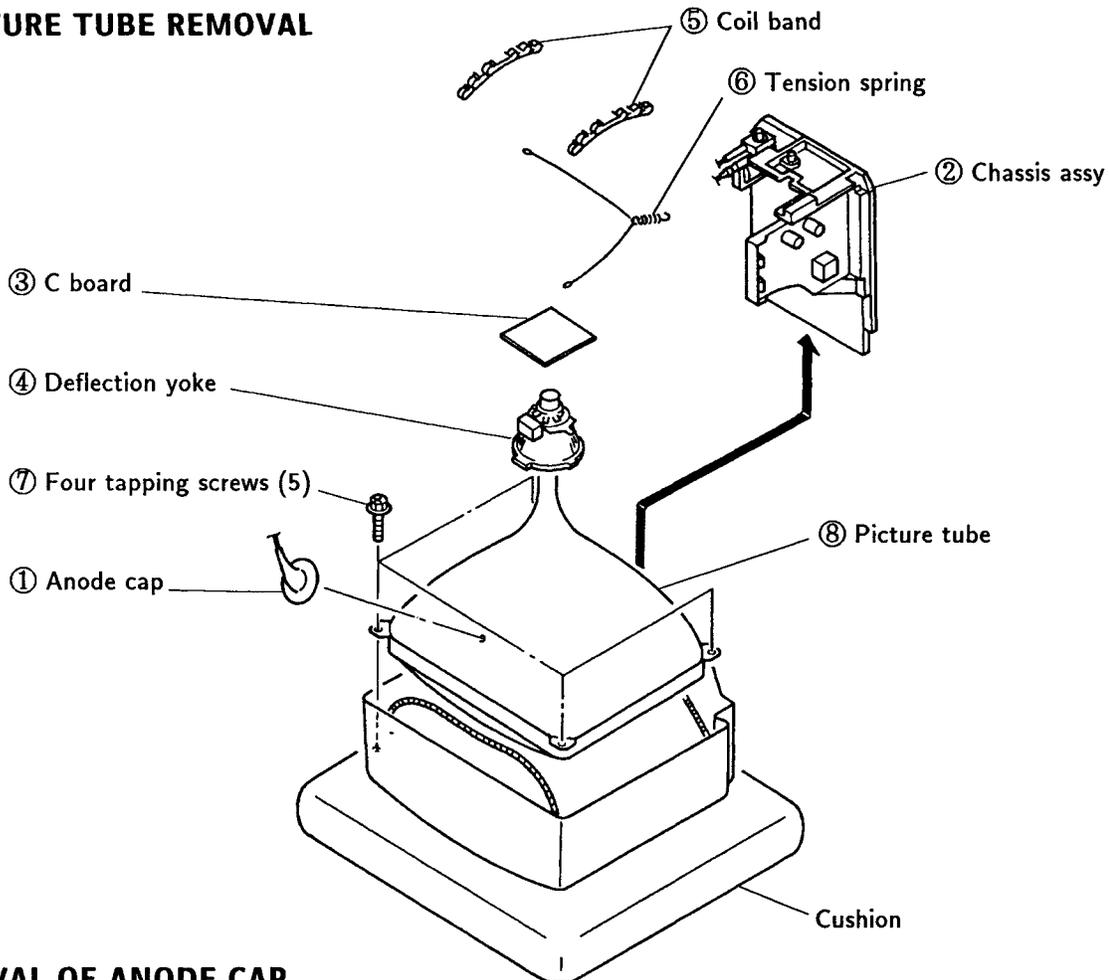

• REMOVAL OF ANODE-CAP

NOTE : Short circuit the anode of the picture tube and the anode cap to the metal chassis, CRT shield or carbon painted on the CRT, after removing the anode.

• REMOVING PROCEDURES

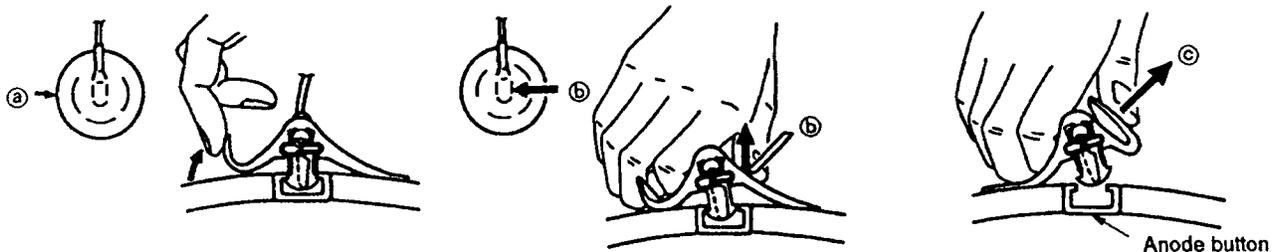

① Turn up one side of the rubber cap in the direction indicated by the arrow ①.

② Using a thumb pull up the rubber cap firmly in the direction indicated by the arrow ②.

③ When one side of the rubber cap is separated from the anode button, the anode-cap can be removed by turning up the rubber cap and pulling up it in the direction of the arrow ③.

• HOW TO HANDLE AN ANODE-CAP

- ① Don't hurt the surface of anode-caps with sharp shaped material!
- ② Don't press the rubber hardly not to hurt inside of anode-caps!
A material fitting called as shatter-hook terminal is built in the rubber.
- ③ Don't turn the foot of rubber over hardly!
The shatter-hook terminal will stick out or hurt the rubber.

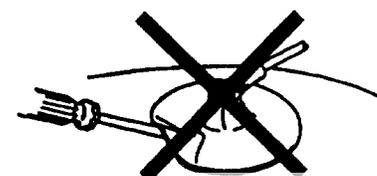
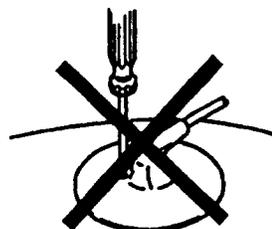

SECTION 3 SET-UP ADJUSTMENTS

- The following adjustments should be made when a complete realignment is required or a new picture tube is installed.
- These adjustments should be performed with rated power supply voltage unless otherwise noted.

The controls and switch should be set as follows unless otherwise noted :

PICTURE control..... normal
BRIGHTNESS control..... normal

Perform the adjustments in order as follows:

1. Beam Landing
2. Convergence
3. Focus
4. Screen (G 2) and White Balance

Note: Test Equipment Required.

1. Color bar Pattern Generator
2. Degausser
3. DC Power Supply
4. Digital multimeter

Preparation:

- Feed in the white pattern signal.
- Before starting, degauss the entire screen.

3-1. BEAM LANDING

1. Input a raster signal with the pattern generator.
2. Loosen the deflection yoke mounting screw, and set the purity control to the center as shown in Fig.2.
3. Turn the raster signal of the pattern generator to green.
4. Move the deflection yoke backward, and adjust with the purity control so that green is in the center and red and blue are at the sides evenly. (Fig.3)
5. Move the deflection yoke forward, and adjust so that the entire screen becomes green. (Fig.1)
6. Switch over the raster signal to red and blue and confirm the condition.
7. When the position of the deflection yoke is determined, tighten it with the deflection yoke mounting screw.
8. When landing at the corner is not right, adjust by using the disk magnets. (Fig.4)

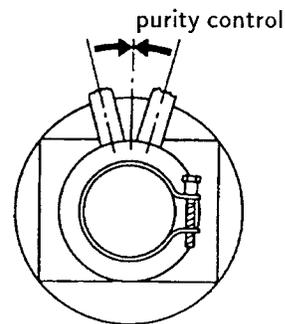

Fig.2

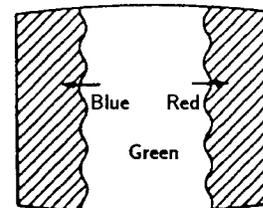

Fig.3

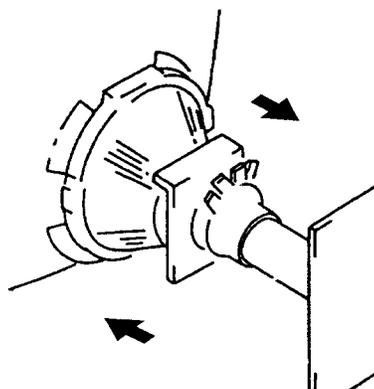

Fig.1

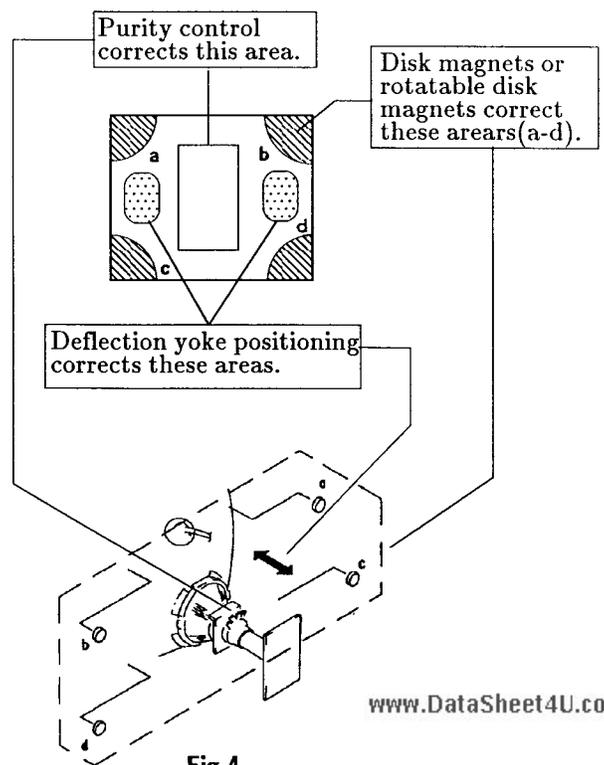

Fig.4

3-2. CONVERGENCE

Preparation:

- Before starting, perform FOCUS, H.SIZE, V.LIN and V.SIZE adjustments.
- Set BRIGHTNESS control to minimum.
- Feed in dot pattern.

(1) Horizontal and Vertical Static Convergence

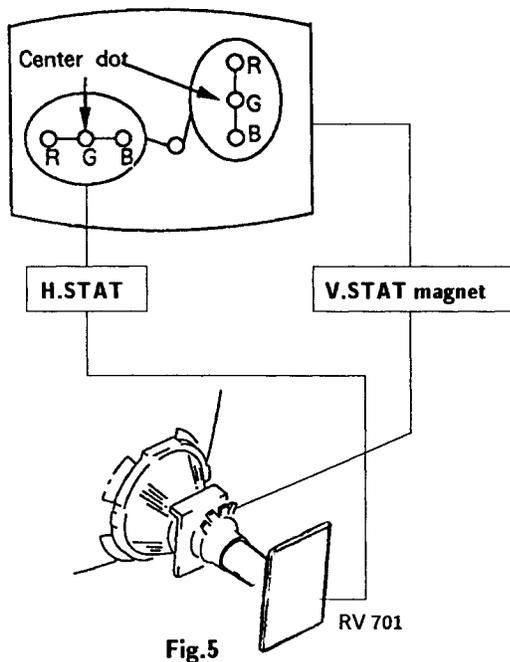
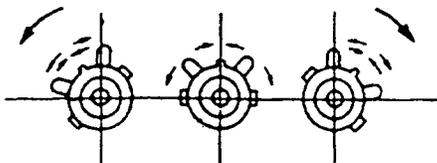
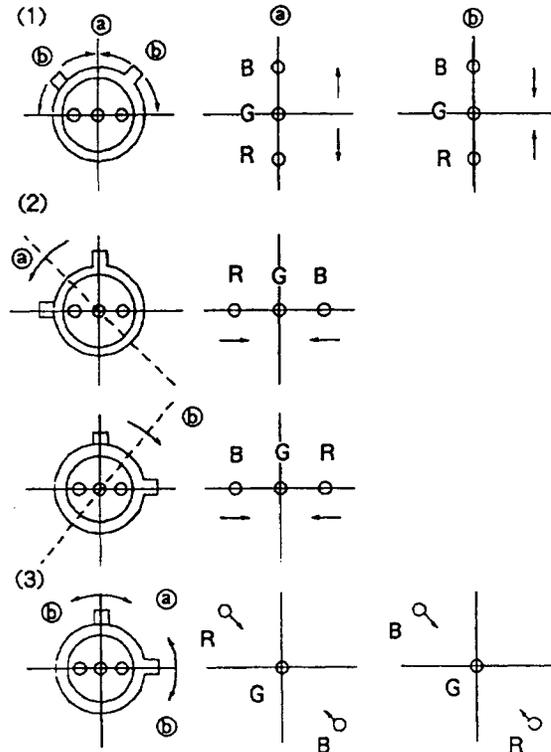

Fig.5

1. Adjust H.STAT VR to converge red, green and blue dots the in center of the screen.(Horizontal movement)
 2. Adjust V. STAT magnet to converge red, green and blue dots in the center of the screen. (Vertical movement)
 3. If the red, green and blue dots do not converge on the center of screen with H.STAT VR, perform horizontal convergence adjustment using H.STAT VR and V.STAT magnet as shown below. (In this case, H.STAT VR and V.STAT magnet effect each other.)
- Tilt the V.STAT magnet and adjust static convergence to open or close the V.STAT magnet.



4. When the V.STAT magnet is moved in the direction of arrow (a) and (b), red, green and blue dots move as shown below.



If the blue dot does not converge with red and green dots, perform following steps.

Move BMC magnet (a) to correct insufficient H.static convergence.

Rotate BMC magnet (b) to correct insufficient V.static convergence.

In either case, repeat Beam Landing Adjustment.

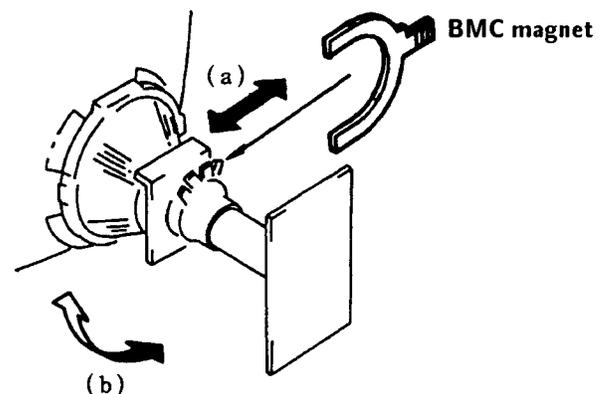

Fig.6

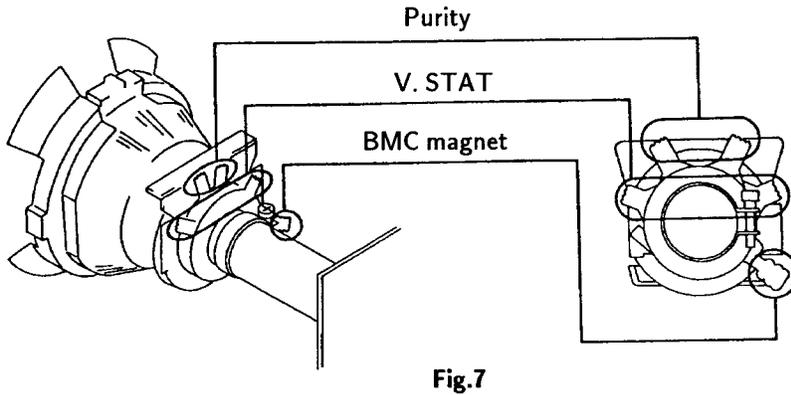

Fig.7

(2)Dynamic Convergence Adjustment

Preparation:

- Before starting perform Horizontal and Vertical static convergence Adjustment.
- 1. Slightly loosen deflection yoke screw.
- 2. Remove deflection yoke spacers.
- 3. Move the deflection yoke for best convergence as shown below.
- 4. Tighten the deflection yoke screw.
- 5. Install the deflection yoke spacers.

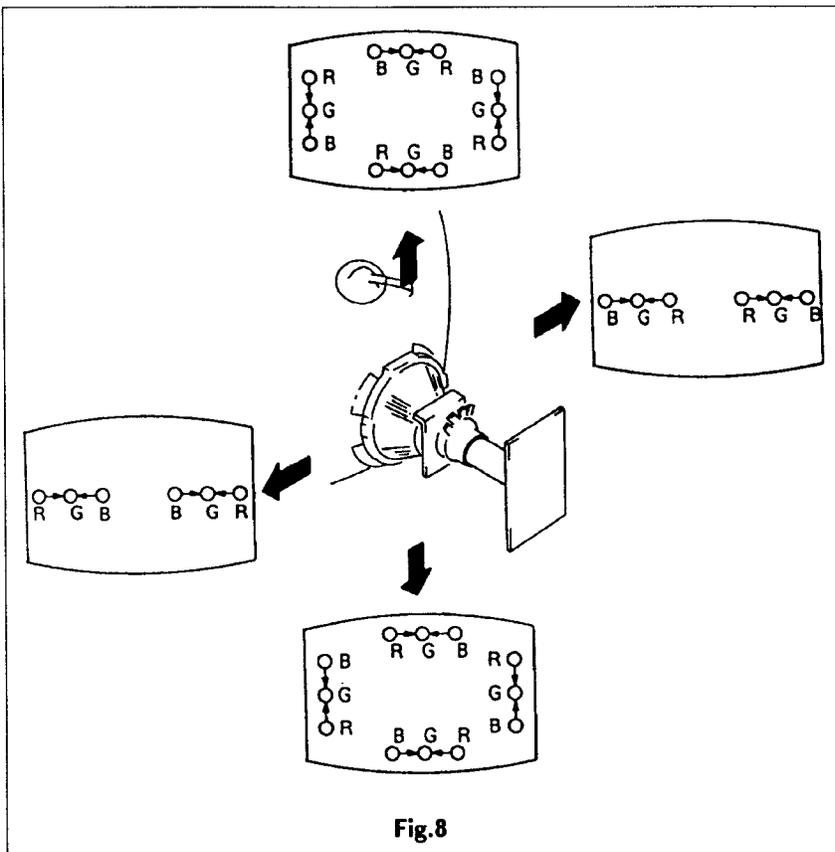

Fig.8

(3) Screen-corner Convergence

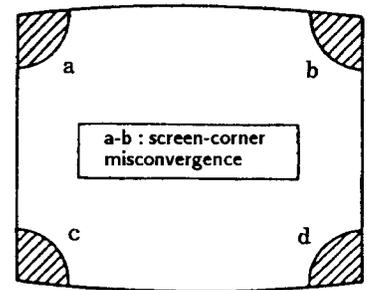
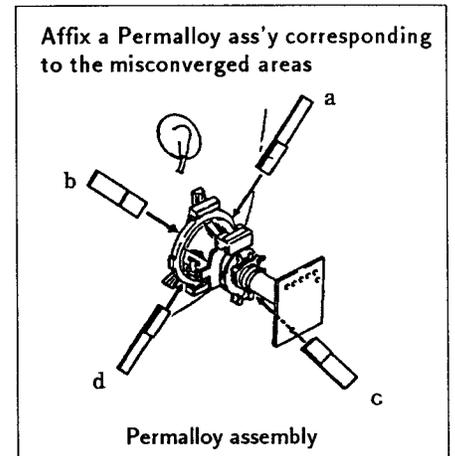

Fig.9



Permalloy assembly

3-3. FOCUS

Adjust FOCUS control for best picture.

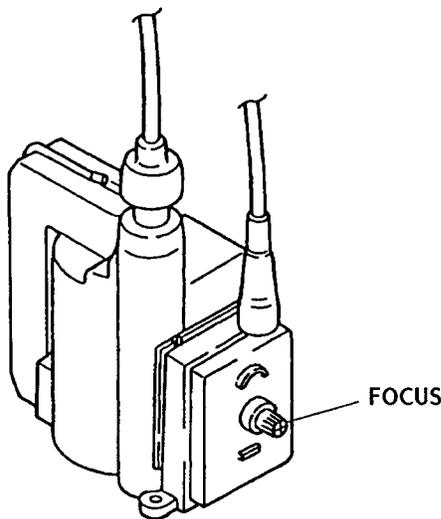

Fig.10

3-4. SCREEN(G 2)

1. Input a dots pattern.
2. Set the PIC, BRT controls at minimum and COLOR control at normal.
3. Adjust BKG VRs so that voltages on the red, green and blue cathodes are 170 V dc with an oscilloscope as shown in Fig.11.
4. Observe the screen and adjust SCREEN (G 2)RV 702 to obtain the faintly visible background of dot signal.

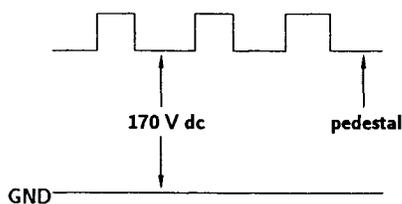

Fig.11

3-5. METHOD OF SETTING THE SERVICE ADJUSTMENT MODE

SERVICE MODE PROCEDURE

1. Standby mode.(Power off)
2. **DISPLAY** → **5** → **VOL (+)** → **POWER** on the Remote Commander. (Press each button within a second.)

SERVICE ADJUSTMENT MODE IN

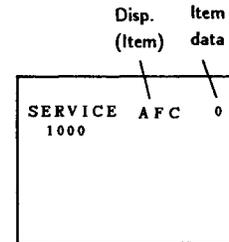

3. The CRT displays the item Being adjusted.
4. Press **1** or **4** on the Remote Commander to select the item.
5. Press **3** or **6** on the Remote Commander to change the data.
6. Press **MUTING** then **ENTER** to write into memory.

SERVICE ADJUSTMENT MODE MEMORY

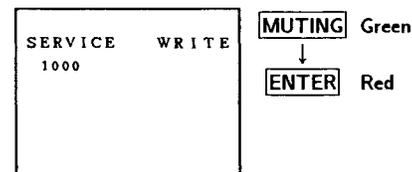

7. Turn set off and on to exit.

3-6. WHITE BALANCE ADJUSTMENTS

1. Input an entire white signal.
2. Set to service adjustment mode.
3. Set the PICTURE and BRIGHT to minimum.
4. Adjust with SBRT if necessary.
5. Select G CUT and B CUT with **1** and **4**.
6. Adjust with **3** and **6** for the best white balance.
7. Set the PICTURE and BRIGHT to maximum.
8. Select GAMP and BAMP with **1** and **4**.
9. Adjust with **3** and **6** for the best white balance.
10. Write into the memory by pressing **MUTING** then **ENTER**.

SECTION 4 SAFETY RELATED ADJUSTMENTS

A BOARD

☒ R537 CONFIRMATION METHOD (HV HOLD-DOWN CONFIRMATION) AND READJUSTMENTS

The following adjustments should always be performed when replacing the following components (marked with ☒ on the schematic diagram).
IC602, D511, C523, C524, R534, R535, R537, R549, R565, R637, PM501, T504, DY

①

1. Preparation before confirmation

- 1) Turn the POWER switch ON, and receive entirely white signal and set the PICTURE and BRIGHT controls to maximum.
- 2) Confirm that the voltage of the check terminal of TP85 is more than 100VDC when the set is operating normally with 120.0 ± 2.0 VAC supply.

2. Hold-down operation confirmation (HV)

- 1) Connect the currentmeter between the 7th pin of FBT (T504) and the land of it with connect polarity.
- 2) Receive White Signal and adjust the ABL current to follows with the PICTURE and the BRIGHT controls.
 $1450 \pm 100 \mu\text{A}$
- 3) Connect the Digital Voltmeter to pin8 of PM501 then read the voltage as A.
- 4) Connect the Digital Voltmeter and DC power Supply via 1SS 119 to TP-85.
- 5) Increase the DC power voltage gradually until the Picture just blanks out.
- 6) Read the digital volymeter indication.
- 7) Turn DC power Source off immediatery.

STANDARD

Less or equal to A + 16.5 VDC

- 8) Receive Dot Signal and adjust the ABL current to follows, with the PIX and the BRT controls.
 $150 \pm 100 \mu\text{A}$
- 9) Repeat steps from (3) to (7).

STANDARD

Less or equal to A + 16.5 VDC

3. Hold-down readjustment

When step 2 is not satisfied, readjustment should be performed by altering the resistance value of R537 (a component marked with ☒).

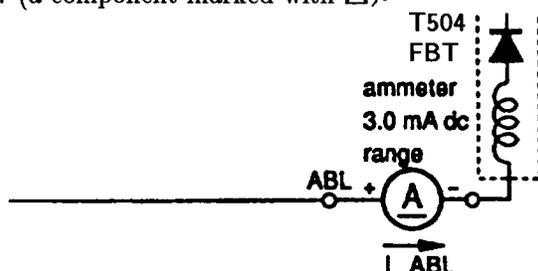

A BOARD

☒ R511 CONFIRMATION METHOD (B+ HOLD-DOWN CONFIRMATION) AND READJUSTMENTS

The following adjustments should always be performed when replacing the following components (marked with ☒ on the schematic diagram).
IC602, C524, R511, R534, R549, R565, R637, PM501

②

1. Hold-Down Operation Voltage (B+)

- 1) Connect the currentmeter between the 7th pin of FBT (T504) and the land of it with connect polarity.
- 2) Receive White Signal and adjust the ABL current to follows with the PICTURE and the BRIGHT controls.
 $1450 \pm 100 \mu\text{A}$
- 3) Connect the Digital Voltmeter and DC power Supply via 1SS 119 to pin8 of PM501.
- 4) Increase the DC power voltage gradually until the Picture just blanks out.
- 5) Read the digital voltmeter indication.
- 6) Turn DC power Source off immediatery.

STANDARD

Less or equal to 130.0 VDC

- 7) Receive Dot Signal and adjust the ABL current to follows, with the PICTURE and the BRIGHT controls.
 $150 \pm 100 \mu\text{A}$
- 8) Repeat steps from (4) to (6).

STANDARD

Less or equal to 132.5 VDC

2. Hold-down readjustment

When step 2 is not satisfied, readjustment should be performed by altering the resistance value of R511 (a component marked with ☒).

G BOARD

B+ VOLTAGE CONFIRMATION

The following adjustments should always be performed when replacing IC602 or R637.

- 1) Supply $130 \pm 2^{\circ}\text{V}$ AC to with variable autotransformer.
- 2) Input an entirely monoscope signal.
- 3) Set the PICTURE control and the BRIGHT controls in to initial reset.
- 4) Confirm the voltage of A BOARD ① pin CN651 connector is less than 116.5V DC.
- 5) If step 4) is not satisfied, replace IC602 and R637 repeat above steps.

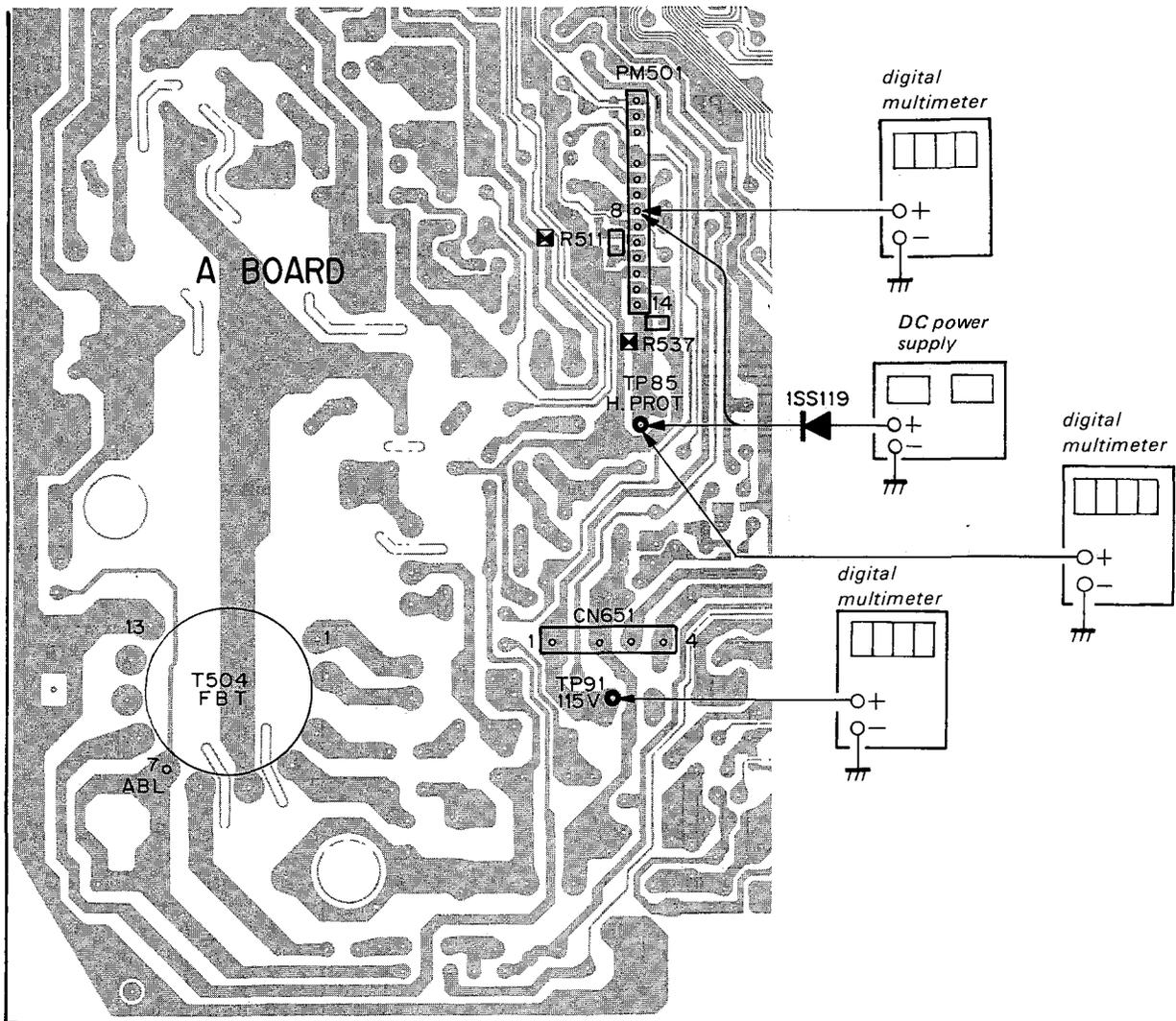
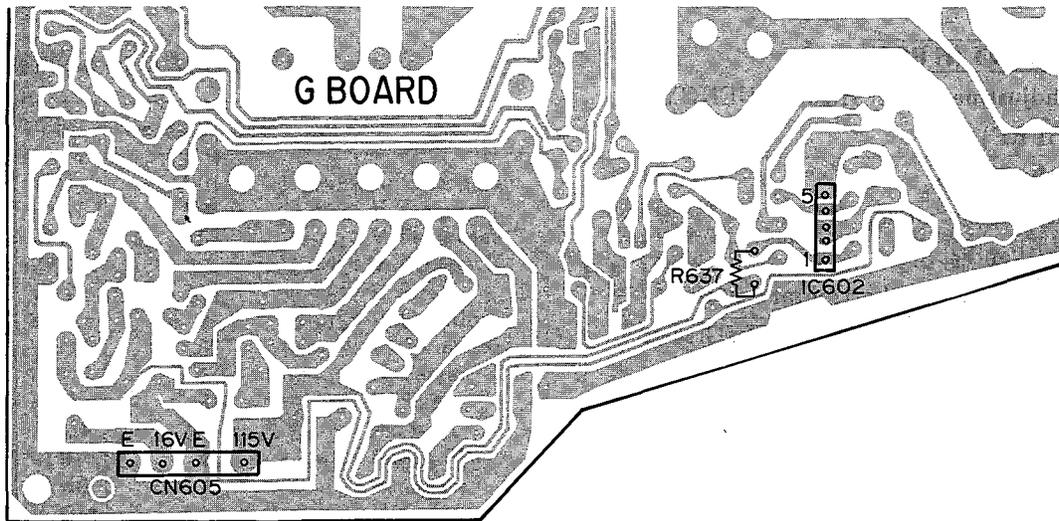

SECTION 5 CIRCUIT ADJUSTMENTS

5-1. ELECTRICAL ADJUSTMENT BY REMOTE COMMANDER

Use of Remote Commander (RM-Y116) can be performed circuit adjustments about this model.

NOTE : Test Equipment Required.

1. Pattern Generator
2. Frequency counter
3. Digital multimeter
4. Audio OSC

1. METHOD OF SETTING THE SERVICE ADJUSTMENT MODE

SERVICE MODE PROCEDURE

- 1) Standby mode.(Power off)
- 2) **DISPLAY** → **5** → **VOL (+)** → **POWER** on the Remote Commander. (Press each button within a second.)

SERVICE ADJUSTMENT MODE IN

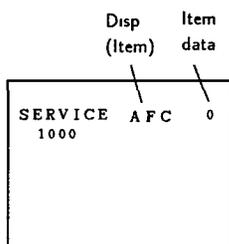

- 3) The CRT displays the item Being adjusted.
- 4) Press **1** or **4** on the Remote Commander to select the item.
- 5) Press **3** or **6** on the Remote Commander to change the data.
- 6) Press **MUTING** then **ENTER** to write into memory.

SERVICE ADJUSTMENT MODE MEMORY

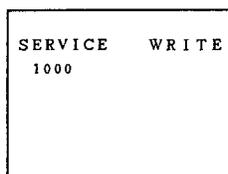

MUTING Green
↓
ENTER Red

- 7) Press **8** then **ENTER** on the Remote Commander to initialize.

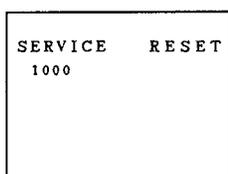

Carry out step 7) when adjusting IDs 0 to 4 and when replacing and adjusting IC102.

Factory original setting

- 8) Turn set off and on to exit.

2. MEMORY WRITE CONFIRMATION METHOD

- 1) After adjustment, pull out the plug from AC outlet, and next place, plug in AC outlet again.
- 2) Turn the power switch ON and set to Service Mode.
- 3) Call the adjusted items again, confirm they were adjusted.

3. ADJUST BUTTONS AND INDICATOR

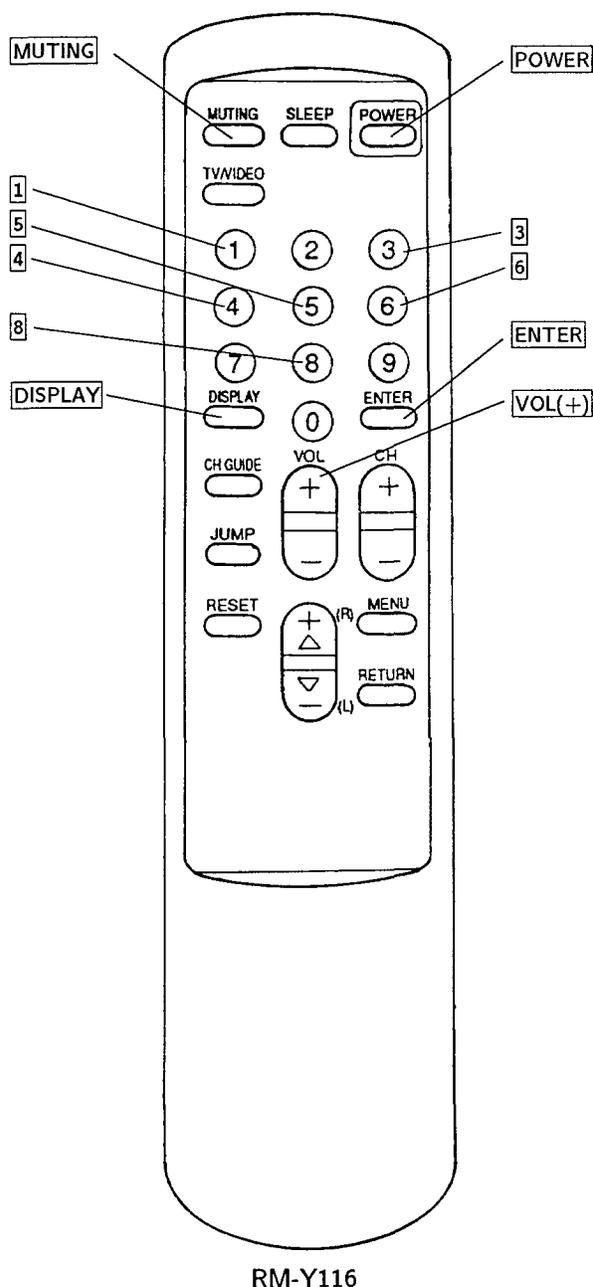

4. AN ITEM OF ADJUSTMENTS

No	Disp.	Ave data	Data range	Item
1	AFC	* 0	0~3	AFC Loop Gain
2	HFRE	78	0~127	H. Frequency
3	VFRE	15	0~31	V. Frequency
4	VPOS	20	0~31	V. Center
5	VSIZ	31	0~63	V. Size
6	VLIN	8	0~15	V Linearity
7	VSCO	6	0~15	V. Correction
8	HPOS	6	0~15	H. Center
9	HSIZ	16	0~31	H. Size
10	PAMP	23	0~31	Pin Amp
11	CPIN	4	0~7	Corner Pin
12	PPHA	7	0~15	Pin Phase
13	VCOM	* 2	0~7	V. Compensation
14	GAMP	21	0~31	Green Amp
15	BAMP	16	0~31	Blue Amp
16	GCUT	6	0~15	Green Cut Off
17	BCUT	7	0~15	Blue Cut Off
18	CROM	26	0~63	Chroma Trap
19	SPIX	32	0~63	Sub Contrast
20	SHUE	25	0~63	Sub Hue
21	SCOL	30	0~63	Sub Color
22	SBRT	34	0~63	Sub Bright
23	RGBP	* 18	0~63	RGB Picture
24	SHAP	* 7	0~15	Sharpness
25	VSMO	* 0	0, 1	V Pull in Range
26	REF	* 2	0~3	Reference line
27	ROFF	1	0, 1	Red Out
28	GOFF	1	0, 1	Green Out
29	BOFF	1	0, 1	Blue Out
30	ABLM	* 0	0, 1	ABL Mode

31	NOTC	* 0	0, 1	Notch On/Off
32	DRGB	* 0	0, 1	OSD intensity
33	VANG	not use	0~63	V Angle
34	DISP	40	0~63	Display Position
35	SVOL	* 0	0~7	Sub Volume
36	SBAL	7	0~7	Sub Balance
37	BASS	not use	0~15	Sub Bass
38	TRE	not use	0~15	Sub Treble
39	UYBO	not use	0~63	Upper Y. Bow
40	LYBO	not use	0~63	Lower Y. Bow
41	HAMP	not use	0~63	H. Amp
42	HTIL	not use	0~63	H. Tilt
43	UCBO	not use	0~63	Upper C Bow
44	UTIL	not use	0~63	Upper Tilt
45	LCBO	not use	0~63	Lower C. Bow
46	LTIL	not use	0~63	Lower Tilt
47	DCSH	not use	0~63	DC. Shift
48	PHPO	not use	0~127	PinP H Position
49	PHUE	not use	0~63	PinP Hue
50	ID-0	* 64	0~127	KV-20TS29/2170RS/21STR2
	ID-0	* 104	0~127	KV-20TS32
51	ID-1	* 33	0~127	Model ID
52	ID-2	* 64	0~127	KV-20TS29 (US)/20TS32 /2170RS/21STR2
	ID-2	* 0	0~127	KV-20TS29 (CND)
53	ID-3	* 0	0~127	Model ID
54	ID-4	* 16	0~127	Model ID

Note No. from 1 to 54 is to show adjustment order

* Set-up value

SERVICE ID 0 64
1000 1000000

Please adjust the function values as shown below when IC 102 on A board was replaced

KV-20TS29 (US)

No	Disp.	Disp	Data
50	ID-0	1 0 0 0 0 0 0	64
51	ID-1	0 1 0 0 0 0 1	33
52	ID-2	1 0 0 0 0 0 0	64
53	ID-3	0 0 0 0 0 0 0	0
54	ID-4	0 0 1 0 0 0 0	16

KV-20TS29 (CND)

No.	Disp	Disp.	Data
50	ID-0	1 0 0 0 0 0 0	64
51	ID-1	0 1 0 0 0 0 1	33
52	ID-2	0 0 0 0 0 0 0	0
53	ID-3	0 0 0 0 0 0 0	0
54	ID-4	0 0 1 0 0 0 0	16

KV-2170RS/21STR2

No	Disp	Disp.	Data
50	ID-0	1 0 0 0 0 0 0	64
51	ID-1	0 1 0 0 0 0 1	33
52	ID-2	0 1 0 0 0 0 0	32
53	ID-3	0 0 0 0 0 0 0	0
54	ID-4	0 0 1 0 0 0 0	16

KV-20TS32

No.	Disp	Disp	Data
50	ID-0	1 1 0 1 0 0 0	104
51	ID-1	0 1 0 0 0 0 1	33
52	ID-2	1 0 0 0 0 0 0	64
53	ID-3	0 0 0 0 0 0 0	0
54	ID-4	0 0 1 0 0 0 0	16

5-2. A BOARD ADJUSTMENTS

RF AGC ADJUSTMENT (IF BLOCK VR)

- 1) Input a color-bar signal.
- 2) Adjust AGC VR of TU 101 so that snow noise and cross-modulation disappear from the picture.
- 3) Confirm them at every channel.

H.FREQUENCY ADJUSTMENT (HFRE)

- 1) Input a color-bar signal.
- 2) Set to Service adjustment Mode.
- 3) Connect a frequency counter to base of Q 550 (TP -86 H.DRIVE).
- 4) Call the item of AFC, set to 3 level (free run).
- 5) Select HFRE with **[1]** and **[4]**.
- 6) Adjust with **[3]** and **[6]** for the 15734 ± 60 Hz.
- 7) Call the item of AFC again, adjust the level "0".
- 8) Write into the memory by pressing **[MUTING]** then **[ENTER]**.

V.FREQUENCY ADJUSTMENT (VFRE)

- 1) Select video 1 with no connecting the signal.
- 2) Set to Service adjustment Mode.
- 3) Connect the frequency counter across connector VDY (+) (CN501) connector and ground.
- 4) Select VFRE with **[1]** and **[4]**.
- 5) Adjust with **[3]** and **[6]** for the 55 ± 0.5 Hz.
- 6) Write the memory by pressing **[MUTING]** then **[ENTER]**.

CROMA TRAP ADJUSTMENT (CROM)

- 1) Input a red signal
- 2) Set to Service adjustment Mode.
- 3) Connect an oscilloscope CN703 Pin① (R OUT) of C board and ground.
- 4) Select CROM with **[1]** and **[4]**.
- 5) Adjust with **[3]** and **[6]** for the 0 level.

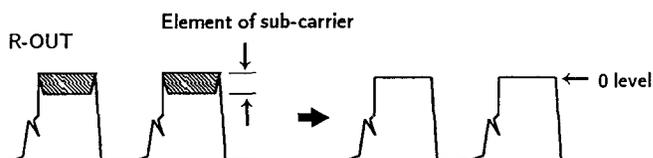

- 6) Write the memory by pressing **[MUTING]** then **[ENTER]**.

SUB CONTRAST ADJUSTMENT (SPIX)

- 1) Input a color-bar signal.
- 2) Set to Service adjustment Mode.
- 3) Set the conditions as follows.

PICTURE MAX
COLOR MIN
BRIGHT MIN

R OFF ON (1)
G OFF OFF (0)
B OFF OFF (0)

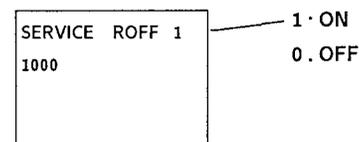

- 4) Connect an oscilloscope to CN703 Pin① (R OUT) of C board and ground.
- 5) Select SPIX with **[1]** and **[4]**.
- 6) Adjust with **[3]** and **[6]** for the 2.0 ± 0.05 Vp-p.

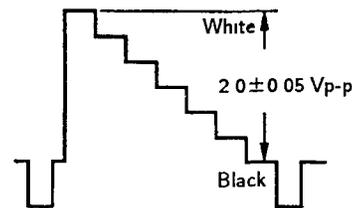

- 7) Write the memory by pressing **[MUTING]** then **[ENTER]**.
- 8) Return the following back to normal after adjustment.

PICTURE MAX
BRIGHT CENTER
COLOR CENTER
R OFF ON
G OFF ON
B OFF ON

DISPLAY POSITION ADJUSTMENT (DISP)

- 1) Input a color-bar signal.
- 2) Set to service adjustment Mode.
- 3) Select DISP with **[1]** and **[4]**.
- 4) Adjust with **[3]** and **[6]** for the bar center.
- 5) Write the memory by pressing **[MUTING]** then **[ENTER]**.

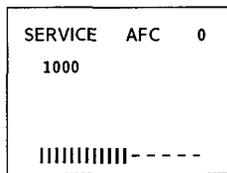

SUB BRIGHT ADJUSTMENT (SBRT)

- 1) Input a cross-hatch signal
- 2) Set to service adjustment mode.
- 3) Set the PICTURE and BRIGHT to minimum.
- 4) Select SBRT with **[1]** and **[4]**.
- 5) Adjust with **[3]** and **[6]** for obtain a faintly visible cross-hatch.
- 6) Write into the memory by pressing **[MUTING]** then **[ENTER]**

SUB BALANCE ADJUSTMENT (SBAL)

- 1) Input a stereo signal.
- 2) Set to service adjustment mode.
- 3) Select SBAL with **[1]** and **[4]**.
- 4) Adjust with **[3]** and **[6]** for the best sound balance.
- 5) Write into the memory by pressing **[MUTING]** then **[ENTER]**.

SUB HUE, SUB COLOR ADJUSTMENT (SHUE, SCOL)

- 1) Input a color-bar signal
- 2) Set to service adjustment Mode.
- 3) Connect an oscilloscope to CN703 Pin③ (B OUT) of C board.
- 4) Select SHUE and SCOL with **[1]** and **[4]**.
- 5) Adjust with **[3]** and **[6]** for the $V1=V4$ (SCOR) and $V2=V3$ (SHUE).

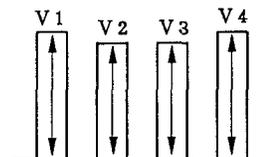

- 6) Write into the memory by pressing **[MUTING]** then **[ENTER]**

V.SIZE ADJUSTMENT (VSIZ)

- 1) Input a cross-hatch signal.
- 2) Set to service adjustment Mode.
- 3) Select VSIZ with **[1]** and **[4]**.
- 4) Adjust with **[3]** and **[6]** for the best vertical size.
- 5) Write into the memory by pressing **[MUTING]** then **[ENTER]**.

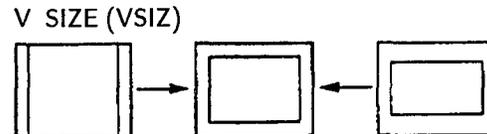

H.SIZE ADJUSTMENT (HSIZ)

- 1) Input a cross-hatch signal.
- 2) Set to service adjustment Mode.
- 3) Select HSIZ with **[1]** and **[4]**.
- 4) Adjust with **[3]** and **[6]** for best horizontal size
- 5) Write into the memory by pressing **[MUTING]** then **[ENTER]**.

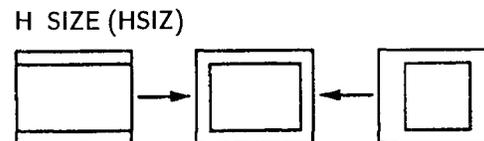

V.CENTER ADJUSTMENT (VPOS)

- 1) Input a cross-hatch signal.
- 2) Set to service adjustment Mode.
- 3) Select VPOS with **[1]** and **[4]**.
- 4) Adjust with **[3]** and **[6]** for the best vertical center.
- 5) Write into the memory by pressing **[MUTING]** then **[ENTER]**.

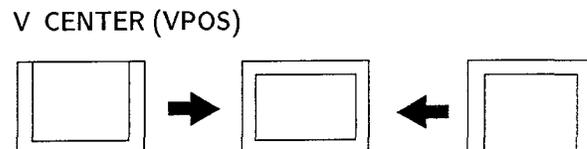

H.CENTER ADJUSTMENT (H POS)

Note. Perform this adjustment after H.FREQUENCY ADJUSTMENT (HFRE)

- 1) Input a cross-hatch signal.
- 2) Set the Service adjustment mode.
- 3) Select HPOS with **1** and **4** .
- 4) Adjust with **3** and **6** to the best horizontal center.
- 5) Write into the memory by pressing **MUTING** then **ENTER** .

H CENTER (HPOS)

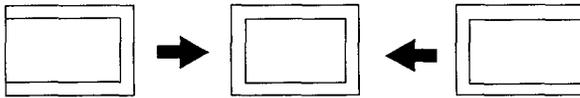

V LINEARITY(VLIN), VS CORRECTION(VSCO), PIN AMP(PAMP), CORNER PIN(CPIN), AND PIN PHASE(PPHA) ADJUSTMENTS

- 1) Input a cross-hatch signal.
- 2) Set to Service adjustment Mode.
- 3) Select VLIN, VSCO, PAMP, CPIN, and PPHA with **1** and **4**.
- 4) Adjust with **3** and **6** for the best picture.
- 5) Write the memory by Pressing **MUTING** then **ENTER**.

V LINEARITY (VLIN)



VS CORRECTION (VSCO)

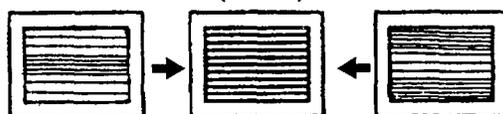

PIN AMP (PAMP)

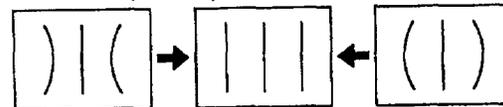

CORNER PIN (CPIN)



PIN PHASE (PPHA)

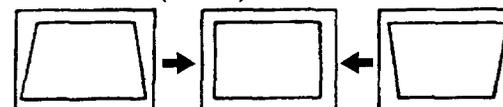

6-2. CIRCUIT BOARDS LOCATION

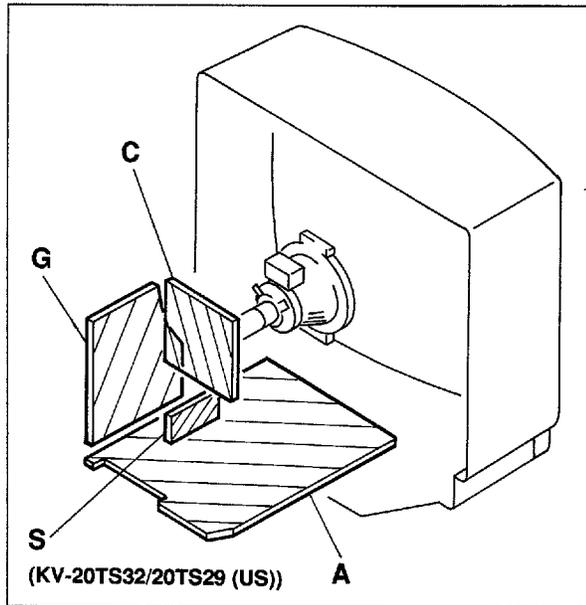

6-3. PRINTED WIRING BOARDS AND SCHEMATIC DIAGRAMS

Note:

- All capacitors are in μF unless otherwise noted.
pF: μF 50WV or less are not indicated except for electrolytic and tantalums.
- All electrolytics are in 50V unless otherwise specified.
- Indication of resistance, which does not have one for rating electrical power, is as follows.

Pitch: 5 mm
Rating electrical power 1/4W

- All resistors are in ohms.
 $\text{k}\Omega=1000\Omega$, $\text{M}\Omega=1000\text{K}\Omega$
- : nonflammable resistor.
- : internal component.
- : panel designation, and adjustment for repair.
- All variable and adjustable resistors have characteristic curve B, unless otherwise noted.
- The components identified by in this manual have been carefully factory-selected for each set in order to satisfy regulations regarding X-ray radiation. Should replacement be required, replace only with the value originally used.
- When replacing components identified by , make the necessary adjustments indicated. If results do not meet the specified value, change the component identified by and repeat the adjustment until the specified value is achieved.
(Refer to R511 and R537 on page 30,31)
- When replacing the part in below table be sure to perform the related adjustment.

Part replaced ()	Adjustment ()
C524, R511, R534, R549, R565, PM501 } IC602, R637	A BOARD G BOARD B+ HOLD-DOWN (R511)
D511, C523, C524, R534, R535, R537, R549, R565, PM501, T504 } IC602, R637 DY	A BOARD G BOARD HV HOLD-DOWN (R537)

- All voltages are in V.
- Voltage are dc with respect to ground unless otherwise noted.
- Readings are taken with a 10 M Ω digital multimeter.
- Readings are taken with a color-bar signal input.
- Voltage variations may be noted due to normal production tolerance.
- Circled numbers are waveform references.
- : B+ Line.
- : signal path.

Reference information

RESISTOR	: RN	METAL FILM
	: RC	SOLID
	: FPRD	NONFLAMMABLE CARBON
	: FUSE	NONFLAMMABLE FUSIBLE
	: RW	NONFLAMMABLE WIREWOUND
	: RS	NONFLAMMABLE METAL OXIDE
	: RB	NONFLAMMABLE CEMENT
	: *	ADJUSTMENT RESISTOR
COIL	: LF-8L	MICRO INDUCTOR
CAPACITOR	: TA	TANTALUM
	: PS	STYROL
	: PP	POLYPROPYLENE
	: PT	MYLAR
	: MPS	METALIZED POLYESTER
	: MPP	METALIZED POLYPROPYLENE
	: ALB	BIPOLAR
	: ALT	HIGH TEMPERATURE
	: ALR	HIGH RIPPLE

Note: The symbol display is on the component side.

The components identified by shading and mark are critical for safety. Replace only with part number specified.

The symbol indicate fast operating fuse. Replace only with fuse of same rating as marked.

Note: Les composants identifiés par un tramé et une marque sont critiques pour la sécurité. Ne les remplacer que par une pièce portant le numéro spécifié.

Le symbole indique une fusible a action rapide. Doit être remplacée par une fusible de même valeur comme maque.

A

TUNING CONTROL, Y/C JUNGLE, TUNER + VIF + MTS
VERTICAL DEFLECTION, HORIZONTAL DEFLECTION, AUDIO AMP
AV SWITCHER, AV TERMINAL

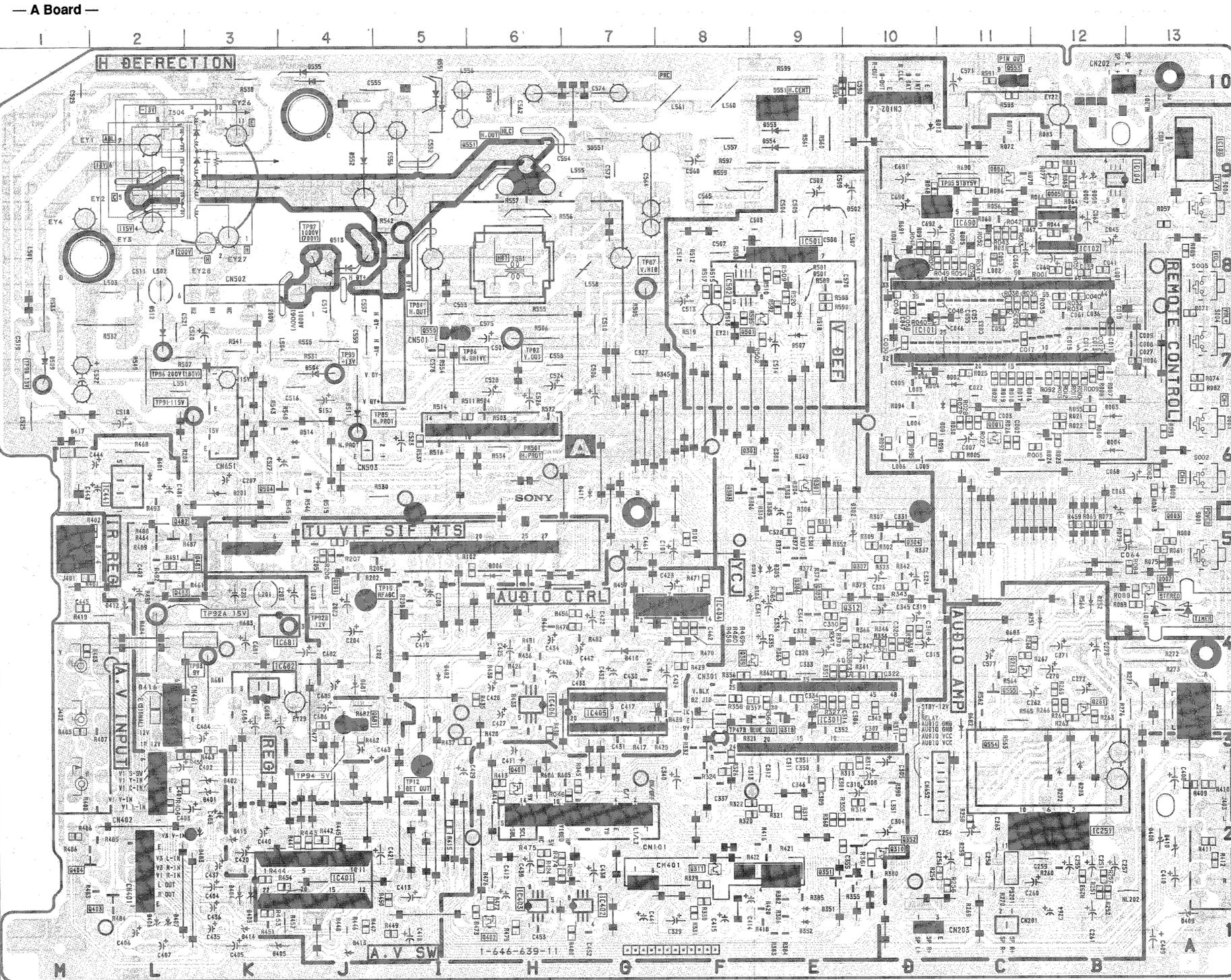

KV-20TS32 (A BOARD)

IC	DIODE
IC101	D-11
IC102	B-12
IC103	B-13
IC251	I-12
IC301	H-9
IC401	I-4
IC402	J-7
IC403	J-6
IC404	F-8
IC501	C-8
IC502	C-8
IC681	G-3
IC682	G-3
IC680	B-11
PM501	E-6

TRANSISTOR	DIODE
Q001	E-11
Q004	B-11
Q005	B-12
Q007	F-13
Q261	G-12
Q262	G-11
Q301	E-9
Q309	G-8
Q310	I-10
Q311	I-8
Q401	H-6
Q402	J-6
Q501	C-9
Q550	C-5
Q551	B-6
Q553	A-11
Q681	H-6

TEST POINT	DIODE
TP15	F-5
TP2	D-6
TP84	C-5
TP85	E-5
TP86	D-5
TP87	C-7
TP89	D-1
TP91	D-2
TP92A	G-2
TP92B	G-4
TP93	G-3
TP94	H-4
TP96	D-2
TP97	C-4
TP99	D-4

A BOARD IC301 CXA1465AS

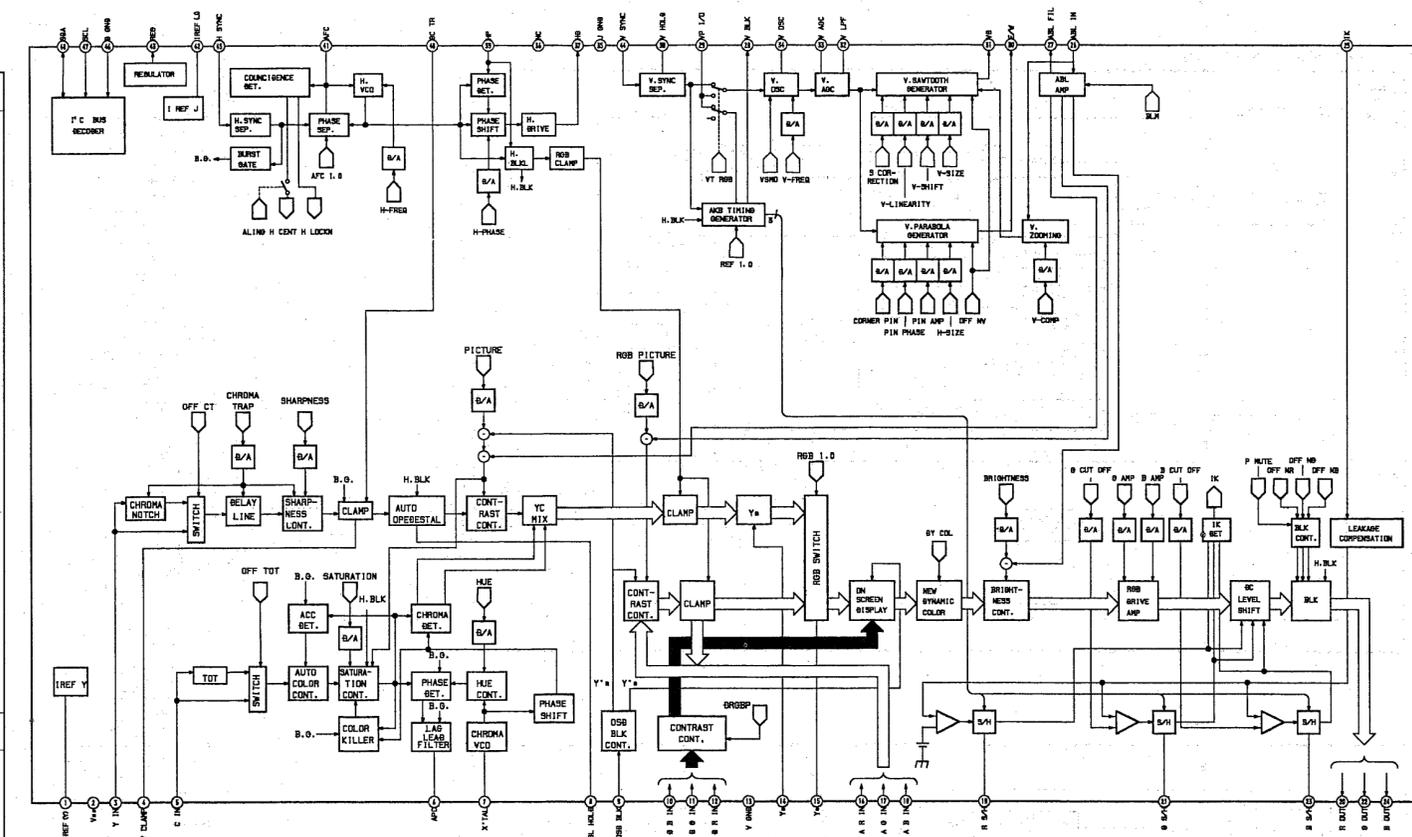

A BOARD IC103 SBX1618-51

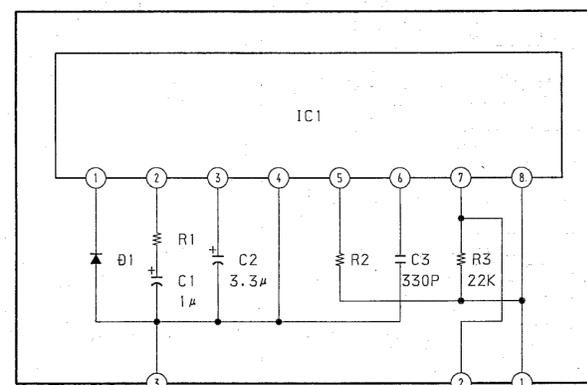

A BOARD IC401 M52470AP

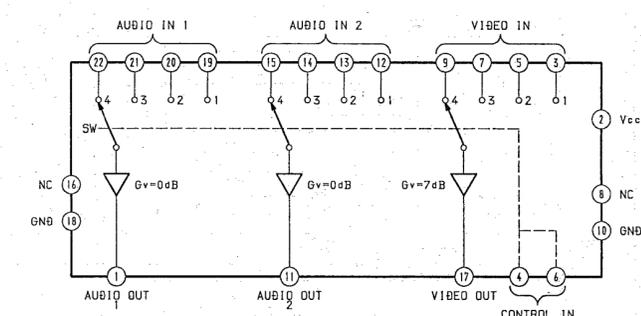

NOTE:
The circuit indicated as left contains high voltage of over 600Vp-p. Care must be paid to prevent an electric shock in inspection or repairing.

• A BOARD IC402, IC403 MM114XFF

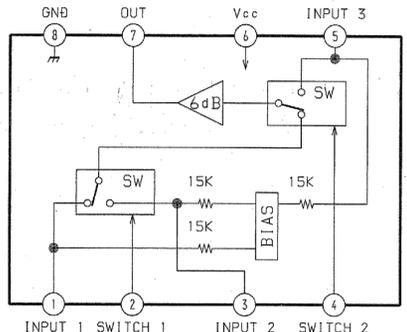

• A BOARD IC404 M51132L

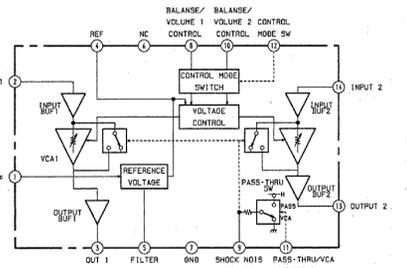

• A BOARD IC501 LA7830

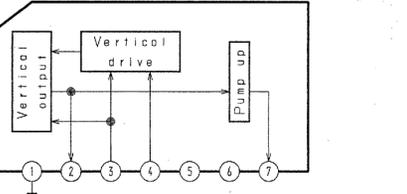

• A BOARD IC690 L78LR05D

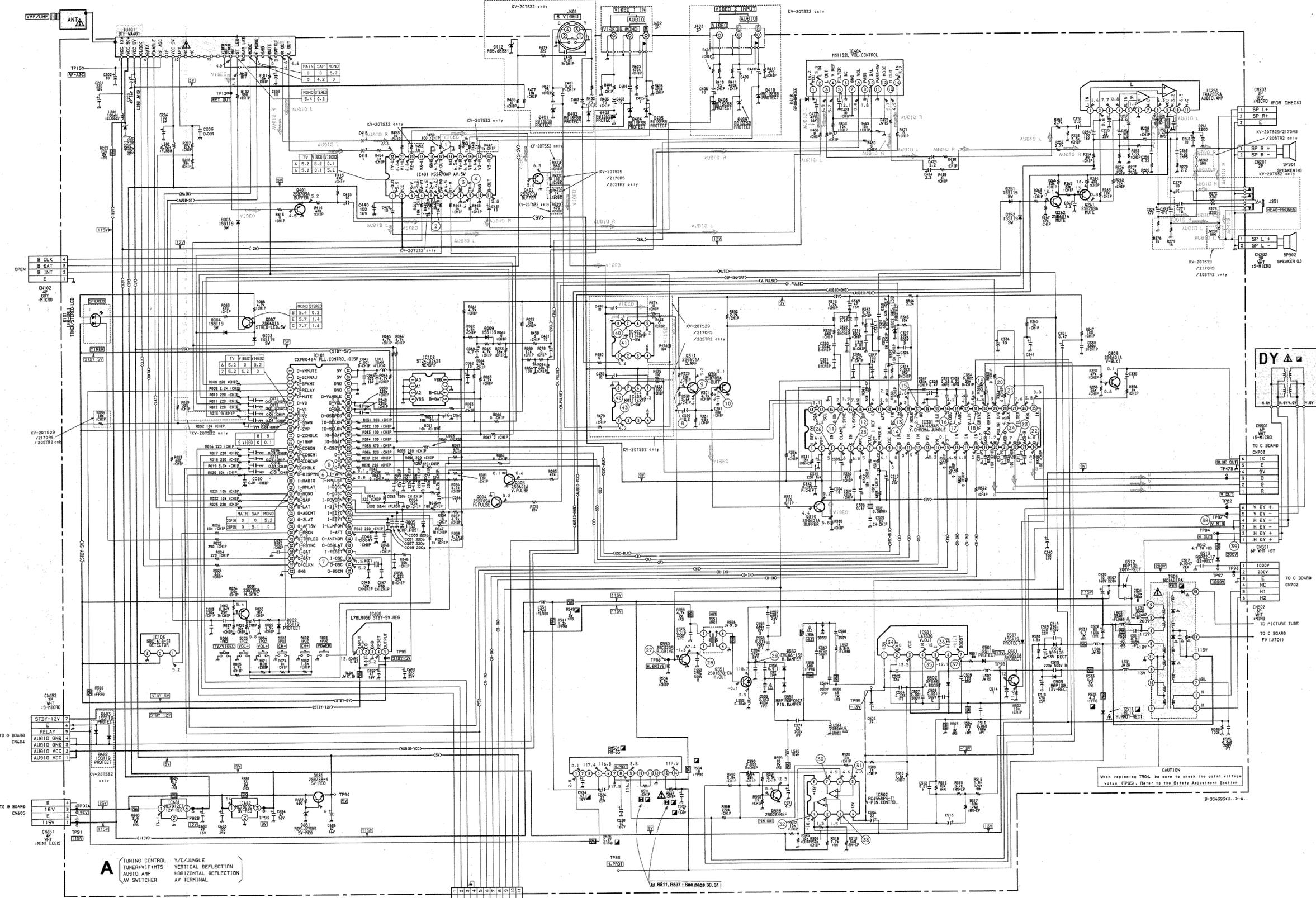
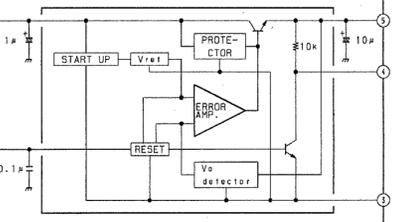

A TUNING CONTROL
TUNER+VIFMETS
AUDIO AMP
AV SWITCHER

Y/C JUNGLE
VERTICAL DEFLECTION
HORIZONTAL DEFLECTION
AV TERMINAL

- A Board -

① TV IN 2.6 Vp-p (H)	① VIDEO IN 2.2 Vp-p (H)	② VIDEO 2 1 Vp-p (H)
③ VIDEO 1 1 Vp-p (H)	④ TV IN 1.2 Vp-p (H)	⑤ 5 Vp-p (V)
⑥ 5 Vp-p (H)	⑦ 5 Vp-p (4.2MHz)	⑧ 0.8 Vp-p (H)
⑨ 2.3 Vp-p (H)	⑩ 2 Vp-p (H)	⑪ 1.6 Vp-p (H)
⑫ 1.6 Vp-p (H)	⑬ 5.3 Vp-p (H)	⑭ 0.35Vp-p (V)
⑮ 4 Vp-p (H)	⑯ 1.6 Vp-p (V)	⑰ 2 Vp-p (V)
⑱ 1.3 Vp-p (V)	⑲ 2 Vp-p (V)	⑳ 3.6 Vp-p (V)
㉑ 4.6 Vp-p (V)	㉒ 4.2 Vp-p (H)	㉓ 4 Vp-p (H)
㉔ 4.2 Vp-p (H)	㉕ 2.4 Vp-p (H)	㉖ 2.4 Vp-p (H)
㉗ 3.5 Vp-p (H)	㉘ 150 Vp-p (H)	㉙ 880 Vp-p (H)
㉚ 17 Vp-p (V)	㉛ 1 Vp-p (V)	㉜ 4 Vp-p (V)
㉝ 0.5 Vp-p (V)	㉞ 52 Vp-p (V)	㉟ 3.2 Vp-p (V)
㊱ 4.3 Vp-p (V)	㊲ 3 Vp-p (V)	㊳ 1.5 Vp-p (V)
㊴ 195 Vp-p (H)	㊵ S VIDEO IN 2 Vp-p (H)	㊶ S VIDEO IN 1 Vp-p (H)
㊷ S VIDEO IN 1.3 Vp-p (H)	㊸ S VIDEO IN 0.7 Vp-p (H)	㊹-㊻ KV-20TS32 only

KV-20TS29/20TS32/2170RS ONLY

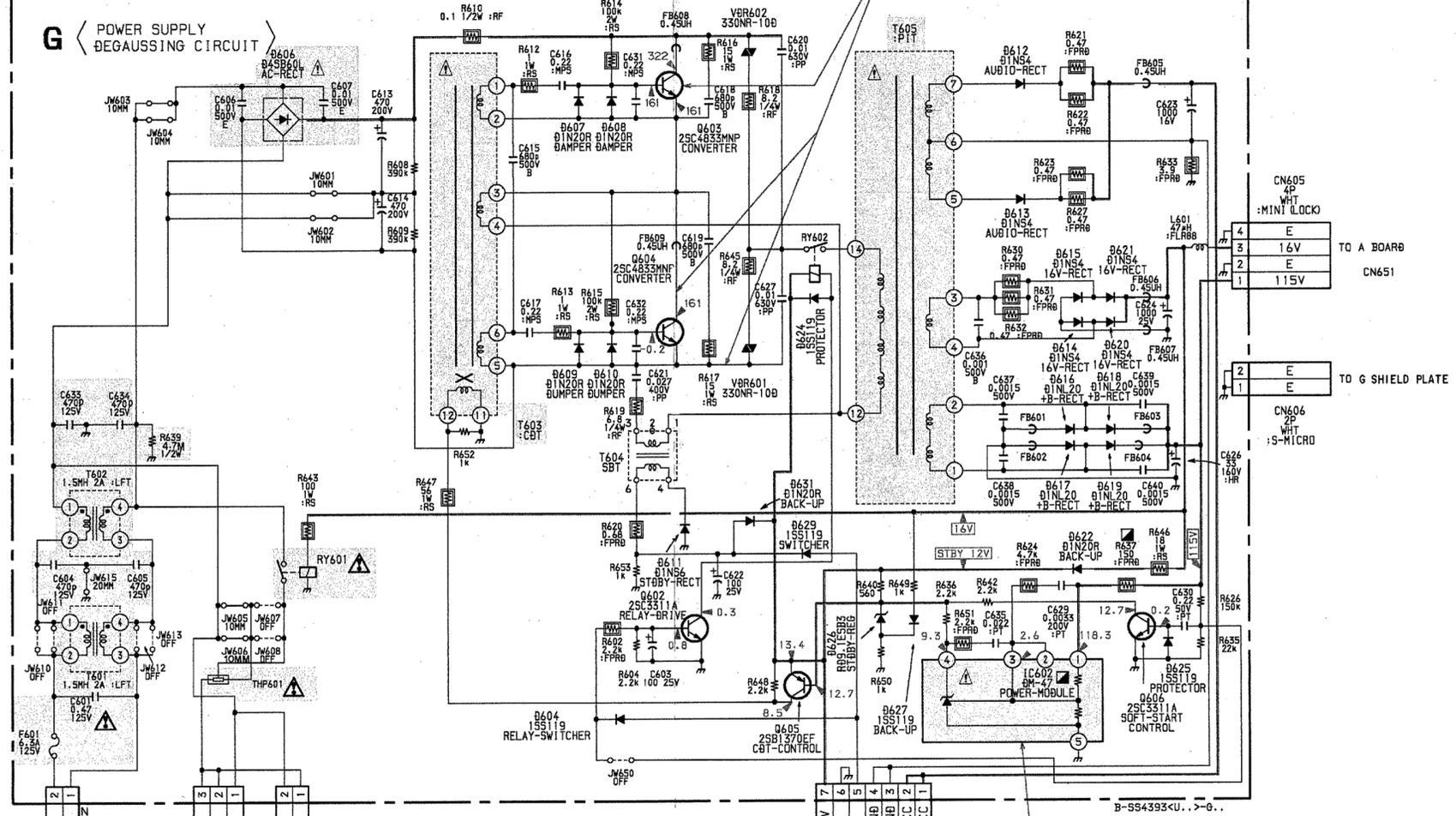

CAUTION
The voltage value of Q603 and Q604 is the reference value between the Q604 emitter

4	E	TO A BOARD
3	16V	CN651
2	E	
1	115V	

2	E	TO G SHIELD PLATE
1	E	

2	E	TO G SHIELD PLATE
1	E	

CAUTION
When replacing IC602, be sure to check the +B line voltage value. Refer to the Safety Adjustment Section

CAUTION (US MODEL ONLY)
This set is equipped with a polarized ac power cord plug (one blade of the plug is wider than the other). When replacing the ac power cord, be sure to connect it with specified part number as shown in this diagram.

KV-21STR2 ONLY

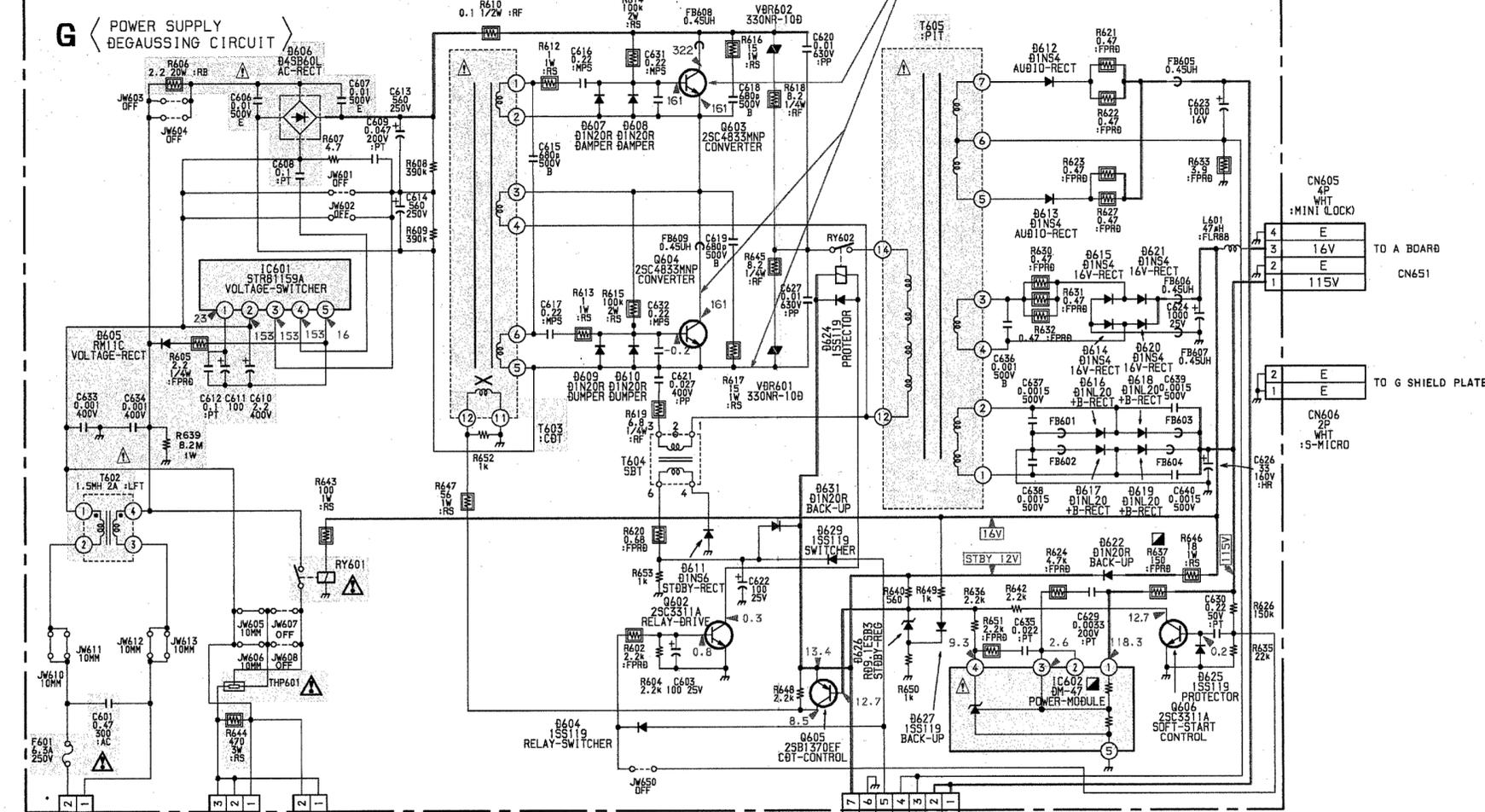

CAUTION
The voltage of Q603 and Q604 is the reference value between the Q604 emitter

4	E	TO A BOARD
3	16V	CN651
2	E	
1	115V	

2	E	TO G SHIELD PLATE
1	E	

2	E	TO G SHIELD PLATE
1	E	

CAUTION
When replacing IC602, be sure to check the +B line voltage value. Refer to the Safety Adjustment Section

CAUTION (US MODEL ONLY)
This set is equipped with a polarized ac power cord plug (one blade of the plug is wider than the other). When replacing the ac power cord, be sure to connect it with specified part number as shown in this diagram.

G

[POWER SUPPLY, DEGAUSSING CIRCUIT]

— G Board —

G BOARD

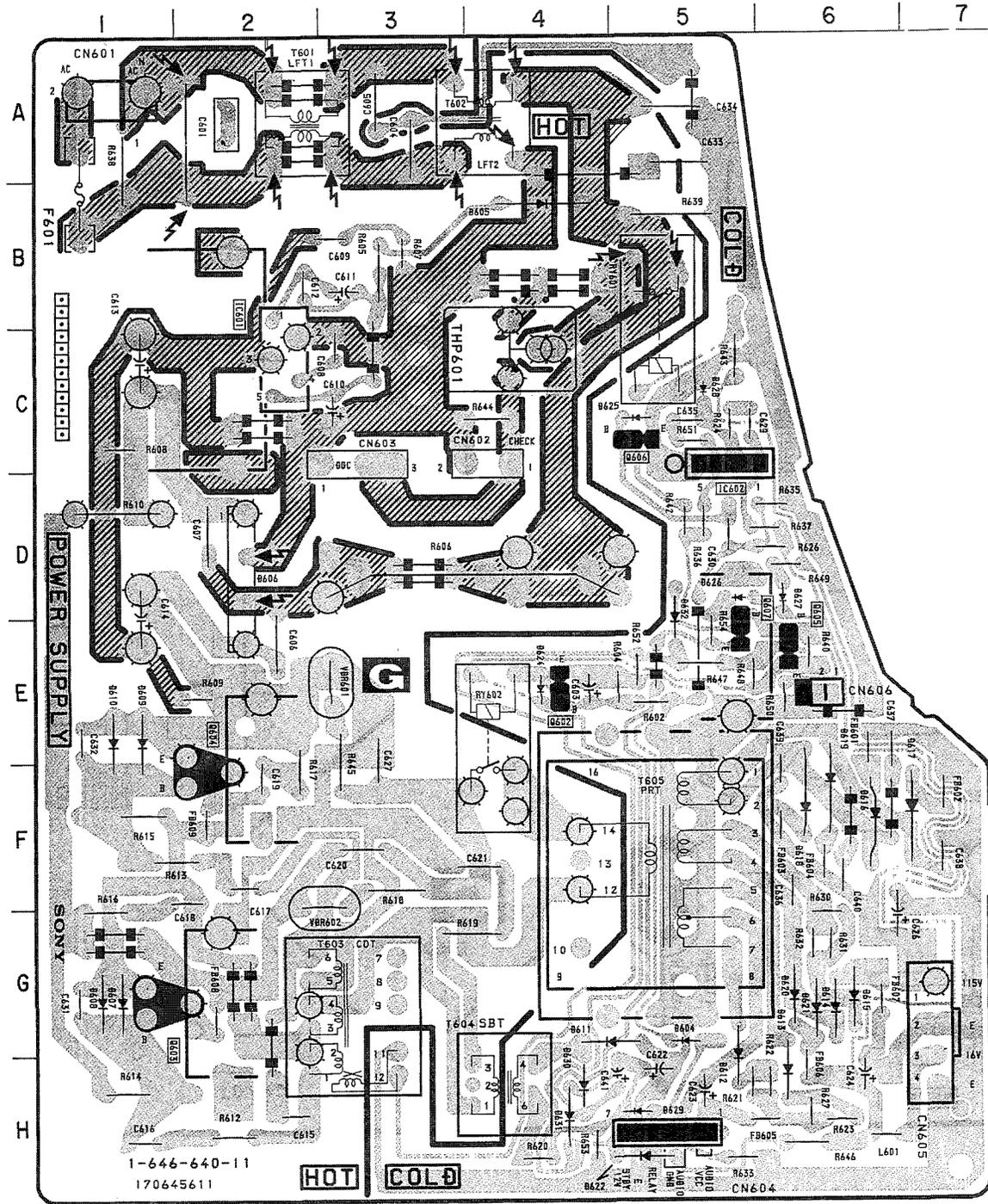

IC	
IC601	B-3
IC602	C-5
TRANSISTOR	
Q602	E-4
Q603	G-1
Q604	F-2
Q605	E-6
Q606	C-5
Q607	E-5
DIODE	
D604	G-5
D605	B-4
D606	D-2
D607	G-1
D608	G-1
D609	E-1
D610	E-1
D611	G-4
D612	H-5
D613	H-6
D614	G-6
D615	G-6
D616	F-6
D617	F-7
D618	F-6
D619	F-6
D620	G-6
D621	G-6
D622	H-5
D624	F-4
D625	C-5
D627	D-6
D629	H-5
D630	H-4
D631	H-4
D632	F-4

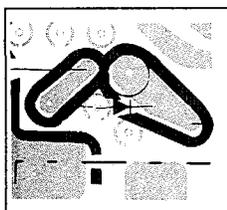

NOTE:
The circuit indicated as left contains high voltage of over 600Vp-p. Care must be paid to prevent an electric shock in inspection or repairing.

C [R.G.B. OUT]

— C Board —

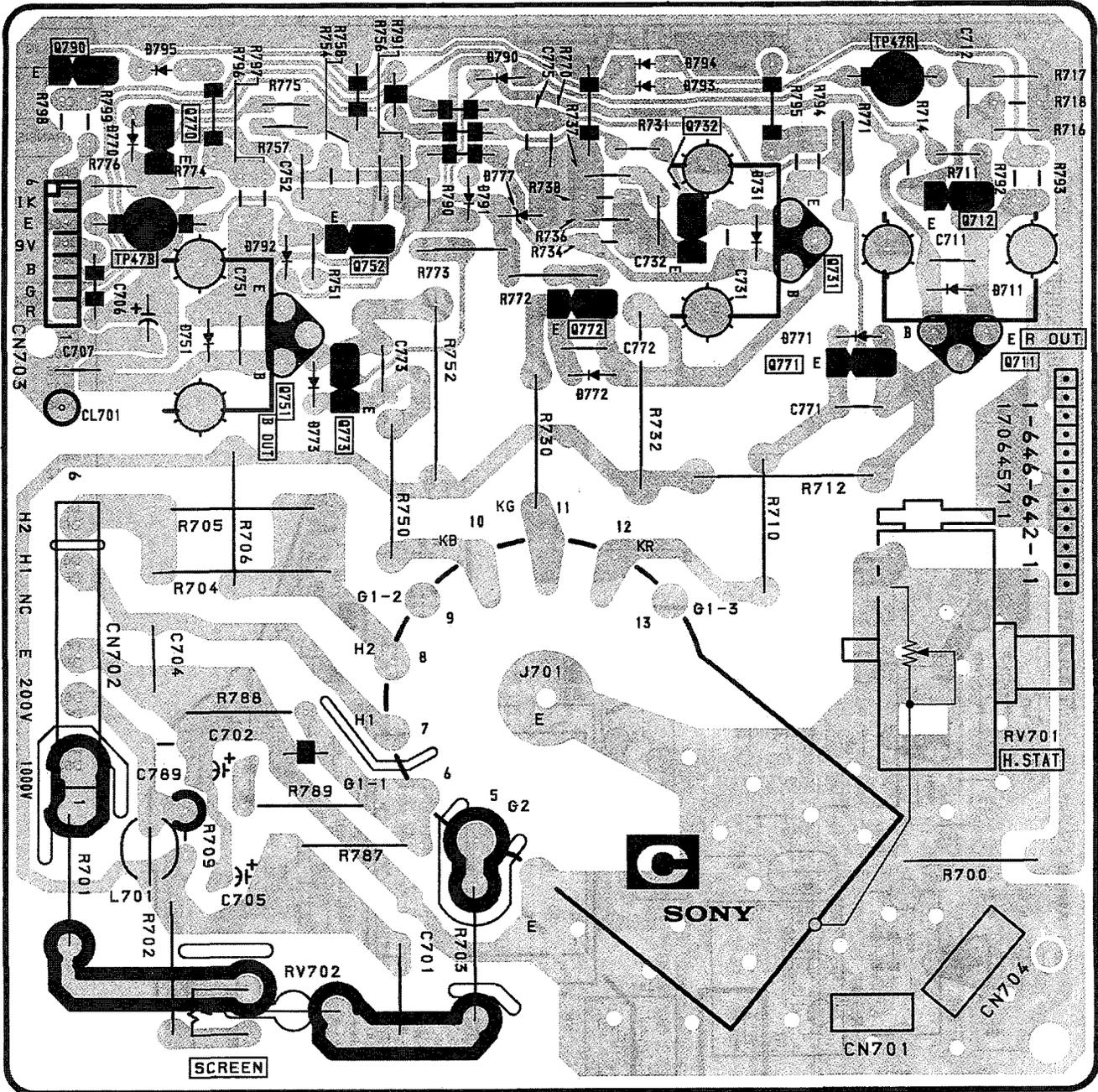

NOTE:

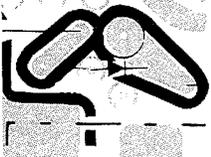

The circuit indicated as left contains high voltage of over 600Vp-p. Care must be paid to prevent an electric shock in inspection or repairing.

1 2 3 4 5 6 7 8 9 10 11 12 13 14 15

A
B
C
D
E
F
G
H
I
J

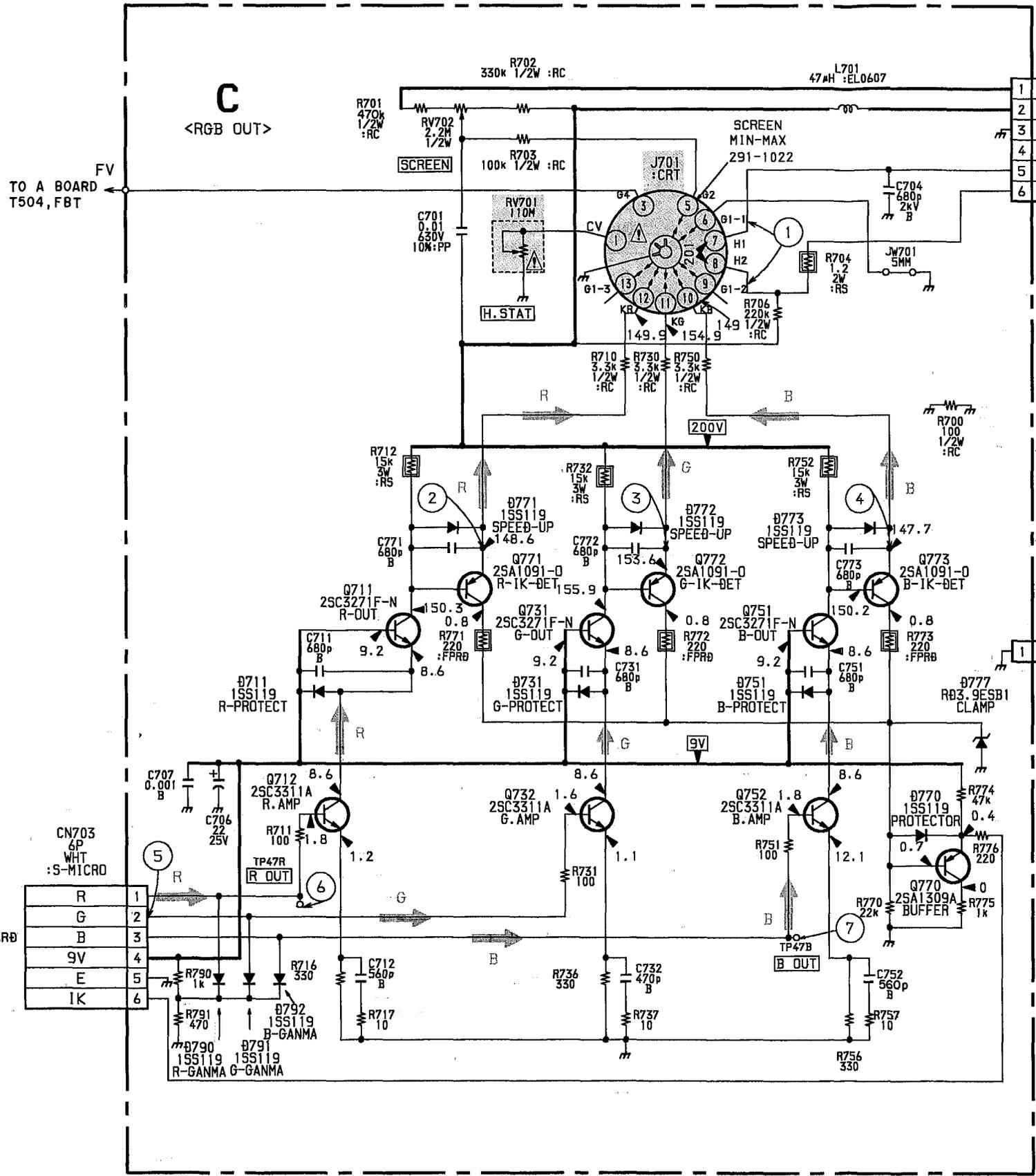

CN702
6P
WHT
:MINI

1	1000V
2	200V
3	E
4	NC
5	H1
6	H2

TO A BOARD
CN502

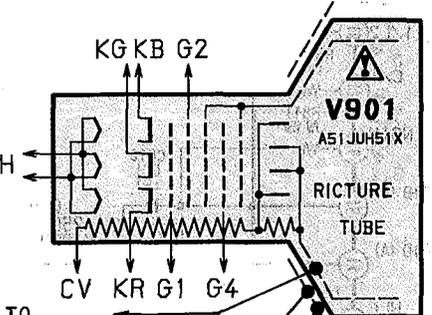

CN701
1P

CAUTION
Be sure connect the connector CN701 for safety.

CN703
6P
WHT
:S-MICRO

R	1
G	2
B	3
9V	4
E	5
IK	6

TO A BOARD
CN301

- C Board -

① 24 Vp-p (H)	② 175 Vp-p (H)	③ 175 Vp-p (H)
④ 175 Vp-p (H)	⑤ 4 Vp-p (H)	⑥ 4 Vp-p (H)
⑦ 4 Vp-p (H)		

B-SS4393<U...>-C..

KV-20TS29/32(US MODEL) ONLY

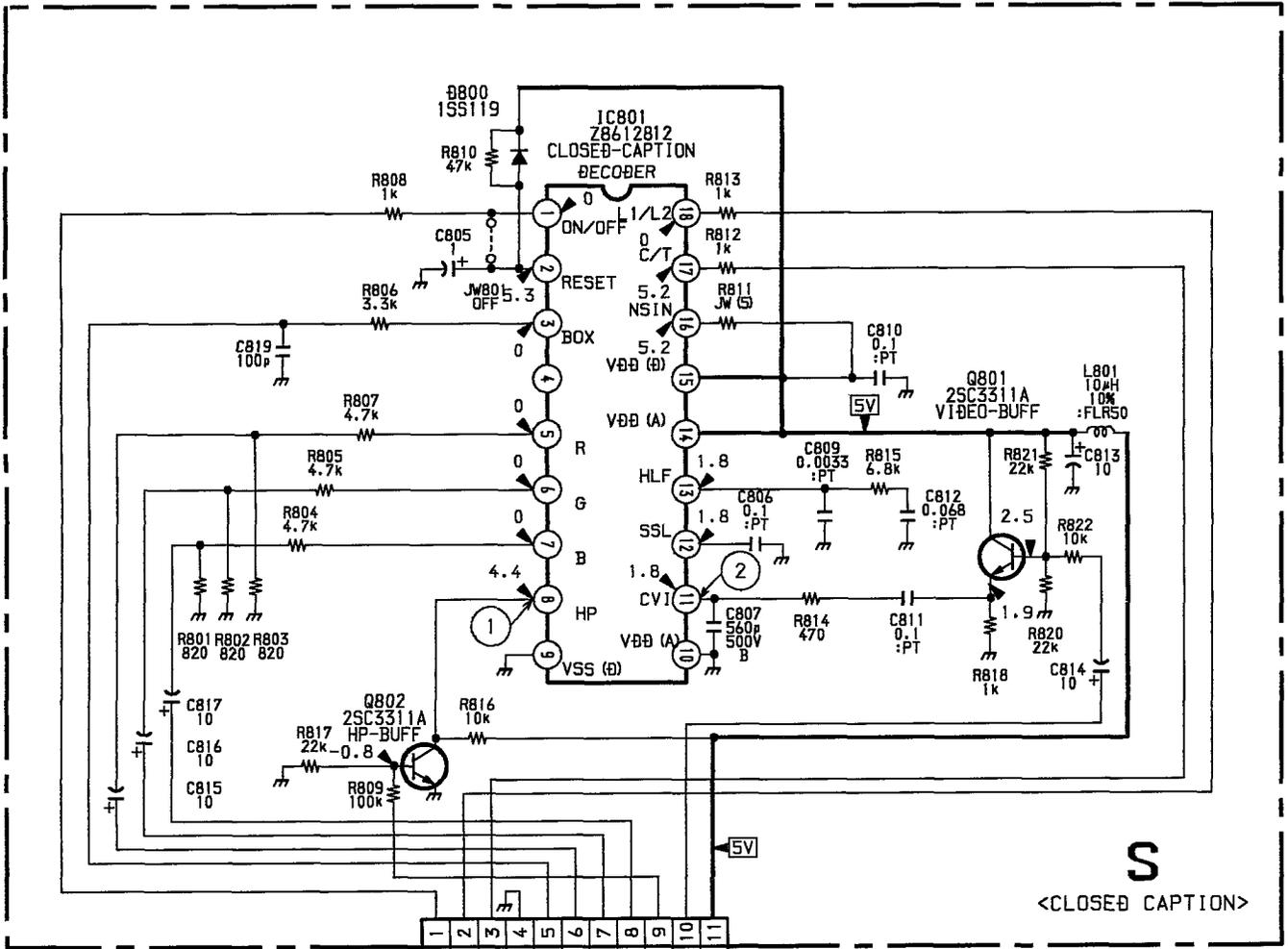

S
<CLOSED CAPTION>

B-554393<U...>-S..

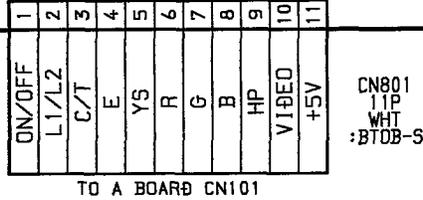

— S Board —

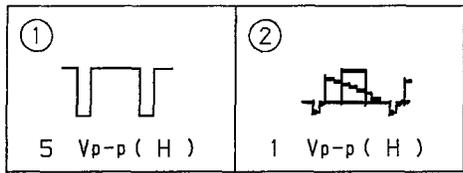

S [CLOSED CAPTION]

— S Board —

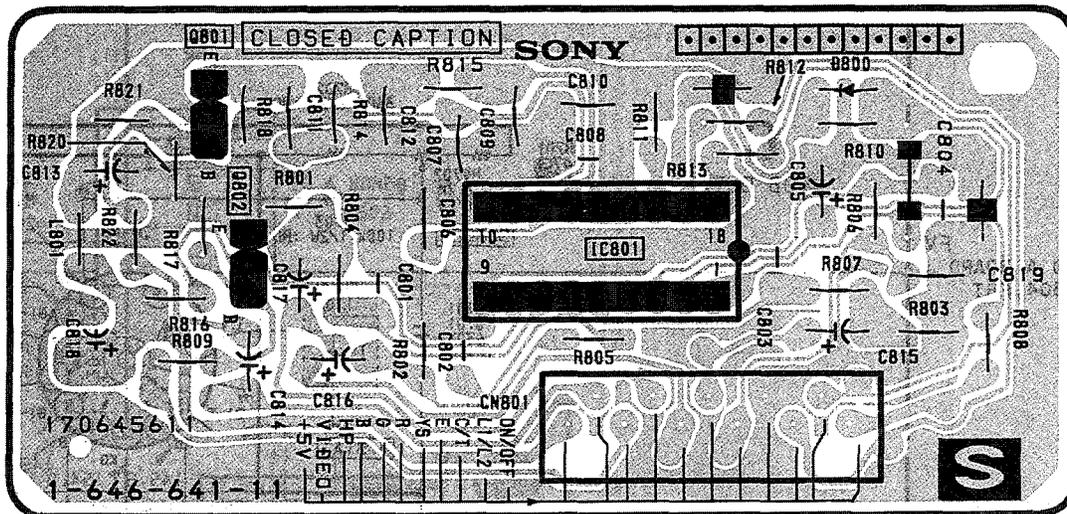

• S BOARD IC801 Z8612812PSC

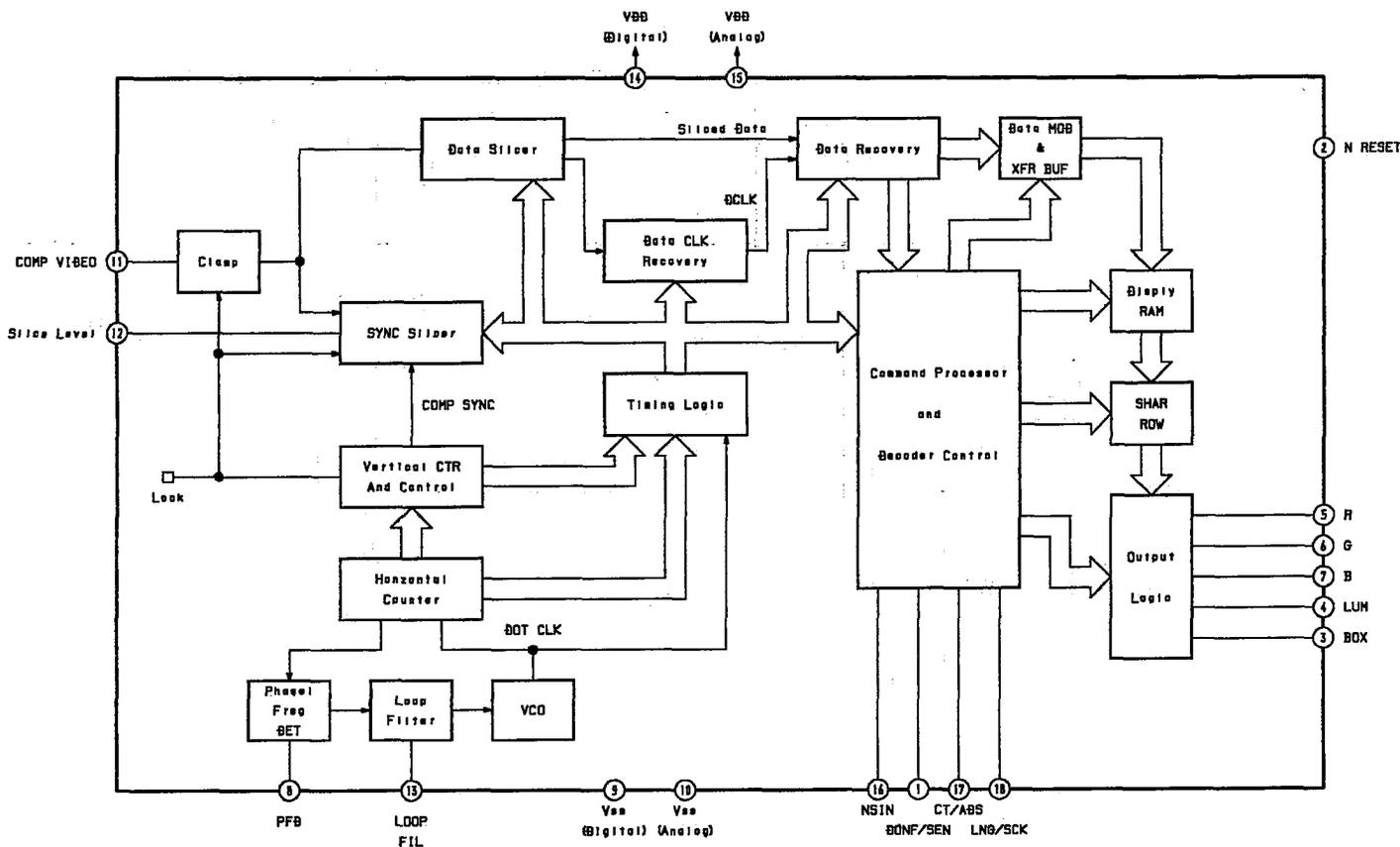

6-4. SEMICONDUCTORS

CXA1465AS



M52470AP
 M52470P

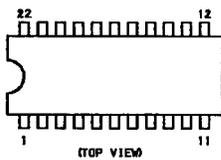

CXP8024-SV4397



PM-35

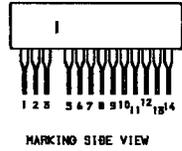

LA7830

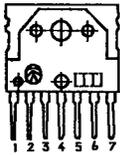

SBX1618-51



LM7812CT
 MC7812CT
 MC7809CT

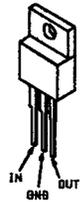

ST24C02AB1

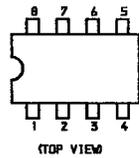

2SA1175
 2SA1309A
 2SC2785
 2SC3311A

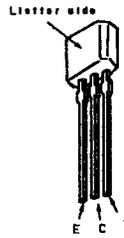

25D1878



Ø45B60L

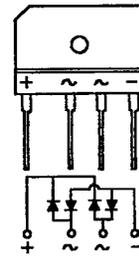

25D2394



ERC06-155

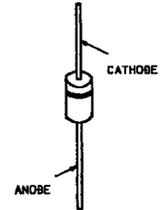

25B1370



25D788



1T33

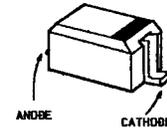

25B709A
 25D601A

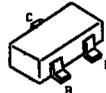

Ø1N54
 Ø1N56
 Ø1N520R
 RØ13ESB2
 RØ30ESB2
 RØ30ESB4
 RØ3.9ESB1
 RØ5.1ESB1
 RØ5.6ESB3
 RØ9.1ESB3
 1SS119
 1SS119TØ

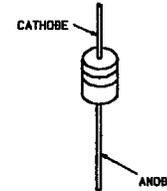

L78LR05Ø-MA



TØA2009A

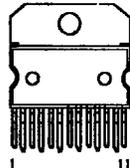

25C3209LK



25C3271F

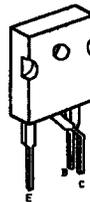

MM1114XFF
 RC4558PS

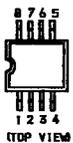

Z8612812PSC

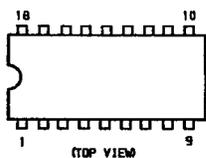

25C4833MNP



Ø1NL20
 EGP20G
 EL1E
 EL1E-V1
 GPØ8Ø
 RGP02-17
 RGP02-17PKG23
 RGP10GPKG3
 RGP15GPKG23

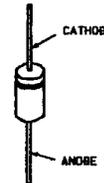

M51132L



2SA10910
 2SA1091-0



SECTION 7 EXPLODED VIEW

NOTE:

- Items with no part number and no description are not stocked because they are seldom required for routine service.
- The construction parts of an assembled part are indicated with a collation number in the remark column.
- Items marked "*" are not stocked since they are seldom required for routine service. Some delays should be anticipated when ordering these items.

The components identified by shading and mark **▲** are critical for safety.
Replace only with part number specified.

Les composants identifiés par une trame et une marque **▲** sont critiques pour la sécurité.
Ne les remplacer que par une pièce portant le numéro spécifié.

7-1. CHASSIS

- : BVTP3x12 7-685-648-79 (BLACK)
- : BVTP3x12 7-685-648-71
- : BVTP4x16 7-685-663-79

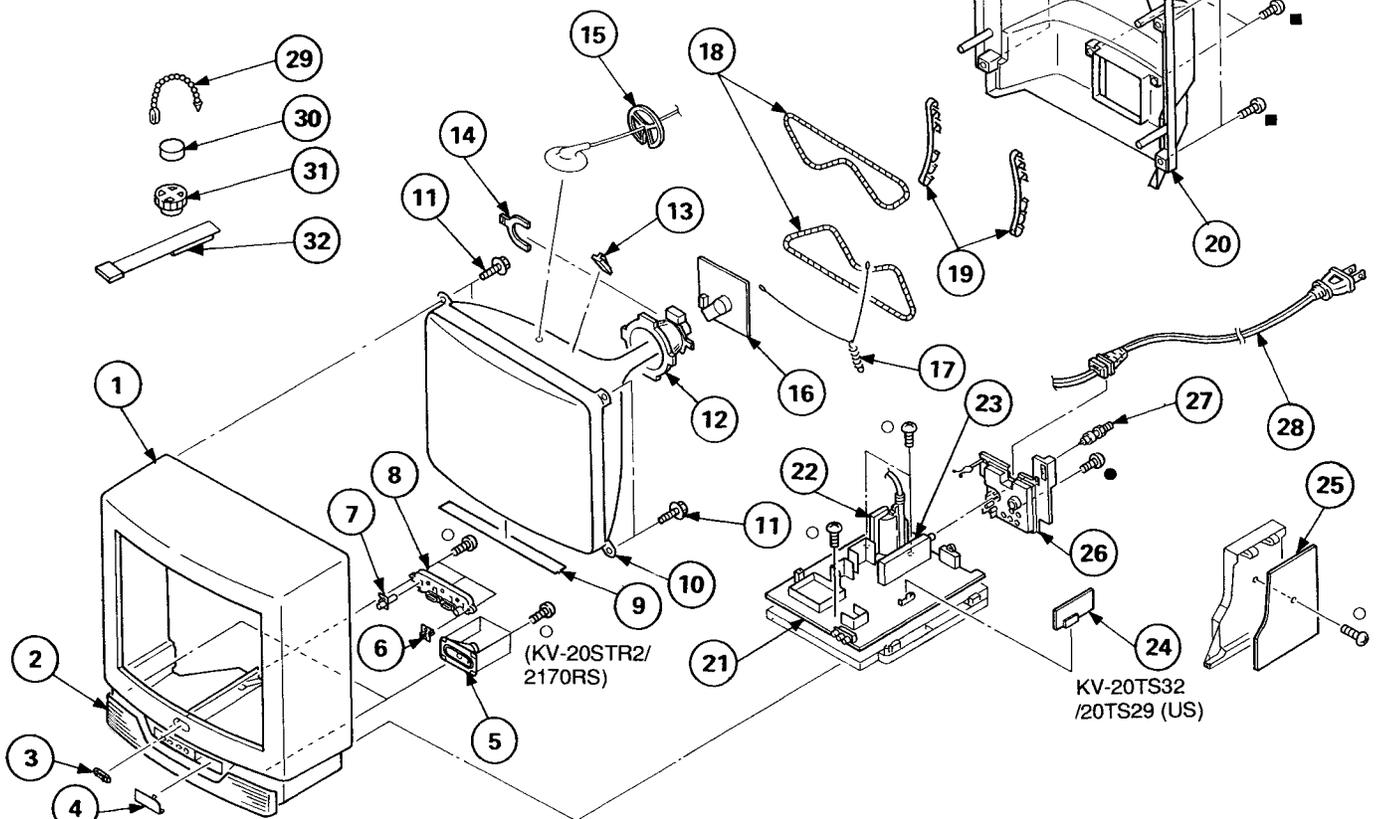

REF. NO.	PART NO.	DESCRIPTION	REMARK	REF. NO.	PART NO.	DESCRIPTION	REMARK
1	4-039-602-01	CABINET (WITH BEZEL)		19	*4-369-319-00	BAND, COIL	
2	X-4030-982-1	GRILLE ASSY, SPEAKER		20	4-039-603-01	COVER, REAR	
3	4-394-072-01	EMBLEM (NO.8), SONY		21	*A-1297-070-A	A BOARD, COMPLETE	
4	4-039-576-01	PANEL (KV-20TS29(U/C), 21STR2, 2170RS)			*A-1297-058-A	A BOARD, COMPLETE (KV-20TS32)	
	4-039-596-01	DOOR, CONTROL (KV-20TS32)		22	▲.1-453-141-11	TRANSFORMER ASSY, FLYBACK (NX-1600A5)	
5	1-504-252-11	SPEAKER (9X5CM)		23	▲.8-598-039-01	TUNER BTF-WA401	
6	4-039-594-01	GUIDE, LED		24	*1-646-641-11	S BOARD (KV-20TS29(U), 20TS32)	
7	4-039-589-01	FILTER, REMOTE		25	*A-1316-146-A	G BOARD, COMPLETE	
8	4-039-595-01	BUTTON, MULTI			*A-1316-148-A	G BOARD, COMPLETE (KV-21STR2)	
9	4-385-725-01	SHEET, BLOTTING		26	4-039-601-01	TERMINAL BOARD, ANTENNA	
10	▲.8-738-764-05	PICTURE TUBE (A51JUH51X)		27	1-573-657-11	PLUG, F-PIN	
11	4-365-808-01	SCREW (5), TAPPING		28	▲.1-751-057-11	CORD, POWER (WITH CONNECTOR)	
12	▲.1-451-280-11	DEFLECTION YOKE (Y21PX2)				(KV-20TS29(U/C), 20TS32, 2170RS)	
13	3-704-495-01	SPEAKER, DY		▲.1-751-056-11	CORD, POWER (WITH CONNECTOR)	(KV-21STR2)	
14	1-452-277-00	MAGNET, BMC		29	4-308-870-00	CLIP, LEAD WIRE	
15	*3-704-372-01	HOLDER, HV CABLE		30	1-452-032-00	MAGNET, DISK; 10MM φ	
16	*A-1331-246-A	C BOARD, COMPLETE		31	1-452-094-00	MAGNET, ROTABLE DISK; 15MM φ	
17	*4-375-394-01	SPRING, TENSION		32	X-4308-815-0	PERMALLOY ASSY, CONVERGENCE	
18	▲.1-426-358-11	COIL, DEMAGNETIZATION				(KV-20TS29(U/C), 20TS32, 2170RS)	
	▲.1-426-368-11	COIL, DEMAGNETIZATION (KV-21STR2)					

SECTION 8 ELECTRICAL PARTS LIST

A (KV-20TS29/21STR2/217ORS)

NOTE:

The components identified by shading and mark **Δ** are critical for safety.
Replace only with part number specified.

Les composants identifiés par une trame et une marque **Δ** sont critiques pour la sécurité.
Ne les remplacer que par une pièce portant le numéro spécifié.

• Items marked "*" are not stocked since they are seldom required for routine service. Some delay should be anticipated when ordering these items.

• All variable and adjustable resistors have characteristic curve B, unless otherwise noted.

RESISTORS

• All resistors are in ohms
• F: nonflammable

When indicating parts by reference number, please include the board name.

CAPACITORS

• MF: μ F, PF: μ μ F

• The components identified by **Δ** in this manual have been carefully selected for each set in order to satisfy regulations regarding X-ray radiation.
Should replacement be required, replace only with the value originally used.

COILS

• MMH: mH, UH: μ H

REF. NO.	PART NO.	DESCRIPTION	REMARK	REF. NO.	PART NO.	DESCRIPTION	REMARK
*A-1297-070-A		A BOARD, COMPLETE ***** (KV-20TS29(U/C), 21STR2, 217ORS)		C251	1-124-925-11	ELECT 2.2MF 20%	50V
4-382-854-11		SCREW (M3X10), P, SW (+)		C254	1-126-101-11	ELECT 100MF 20%	16V
		<CAPACITOR>		C255	1-124-916-11	ELECT 22MF 20%	25V
C002	1-163-809-11	CERAMIC CHIP 0.047MF	10% 25V	C256	1-126-101-11	ELECT 100MF 20%	16V
C003	1-163-125-00	CERAMIC CHIP 220PF	5% 50V	C257	1-124-925-11	ELECT 2.2MF 20%	50V
C007	1-124-903-11	ELECT 1MF	20% 50V	C258	1-136-169-00	FILM 0.22MF 5%	50V
C011	1-163-009-11	CERAMIC CHIP 0.001MF	10% 50V	C259	1-136-173-00	FILM 0.47MF 5%	50V
C012	1-163-009-11	CERAMIC CHIP 0.001MF	10% 50V	C260	1-124-907-11	ELECT 10MF 20%	50V
C013	1-163-009-11	CERAMIC CHIP 0.001MF	10% 50V	C261	1-124-556-11	ELECT 2200MF 20%	16V
C014	1-163-009-11	CERAMIC CHIP 0.001MF	10% 50V	C262	1-124-925-11	ELECT 2.2MF 20%	50V
C015	1-163-009-11	CERAMIC CHIP 0.001MF	10% 50V	C263	1-136-169-00	FILM 0.22MF 5%	50V
C016	1-163-009-11	CERAMIC CHIP 0.001MF	10% 50V	C272	1-126-103-11	ELECT 470MF 20%	16V
C017	1-163-009-11	CERAMIC CHIP 0.001MF	10% 50V	C273	1-126-103-11	ELECT 470MF 20%	16V
C018	1-163-009-11	CERAMIC CHIP 0.001MF	10% 50V	C301	1-163-113-00	CERAMIC CHIP 68PF 5%	50V
C019	1-163-009-11	CERAMIC CHIP 0.001MF	10% 50V	C304	1-124-907-11	ELECT 10MF 20%	50V
C020	1-163-009-11	CERAMIC CHIP 0.001MF	10% 50V	C305	1-124-903-11	ELECT 1MF 20%	50V
C030	1-163-125-00	CERAMIC CHIP 220PF	5% 50V	C306	1-163-035-00	CERAMIC CHIP 0.047MF	50V
C039	1-163-125-00	CERAMIC CHIP 220PF	5% 50V	C307	1-163-125-00	CERAMIC CHIP 220PF	5% 50V
C040	1-163-125-00	CERAMIC CHIP 220PF	5% 50V	C308	1-124-902-00	ELECT 0.47MF 20%	50V
C041	1-163-009-11	CERAMIC CHIP 0.001MF	10% 50V	C309	1-163-099-00	CERAMIC CHIP 18PF 5%	50V
C043	1-163-159-00	CERAMIC CHIP 12PF	2% 50V	C310	1-124-916-11	ELECT 22MF 20%	25V
C045	1-126-103-11	ELECT 470MF	20% 16V	C311	1-137-399-11	FILM 0.1MF 5%	50V
C046	1-163-017-00	CERAMIC CHIP 0.0047MF	10% 50V	C312	1-137-399-11	FILM 0.1MF 5%	50V
C047	1-104-896-91	CERAMIC CHIP 24PF	2% 50V	C313	1-137-399-11	FILM 0.1MF 5%	50V
C048	1-216-049-00	METAL GLAZE 1K	5% 1/10W	C314	1-163-037-11	CERAMIC CHIP 0.022MF	10% 25V
C049	1-163-125-00	CERAMIC CHIP 220PF	5% 50V	C315	1-124-120-11	ELECT 220MF 20%	16V
C050	1-163-109-00	CERAMIC CHIP 47PF	5% 50V	C318	1-163-117-00	CERAMIC CHIP 100PF 5%	50V
C051	1-163-125-00	CERAMIC CHIP 220PF	5% 50V	C319	1-124-902-00	ELECT 0.47MF 20%	50V
C052	1-163-125-00	CERAMIC CHIP 220PF	5% 50V	C320	1-163-017-00	CERAMIC CHIP 0.0047MF	10% 50V
C053	1-163-121-00	CERAMIC CHIP 150PF	5% 50V	C321	1-163-005-11	CERAMIC CHIP 470PF	10% 50V
C054	1-163-253-11	CERAMIC CHIP 120PF	5% 50V	C322	1-163-011-11	CERAMIC CHIP 0.0015MF	10% 50V
C055	1-163-125-00	CERAMIC CHIP 220PF	5% 50V	C323	1-163-007-11	CERAMIC CHIP 680PF	10% 50V
C056	1-163-125-00	CERAMIC CHIP 220PF	5% 50V	C324	1-124-903-11	ELECT 1MF 20%	50V
C057	1-163-125-00	CERAMIC CHIP 220PF	5% 50V	C325	1-164-232-11	CERAMIC CHIP 0.01MF	10% 50V
C058	1-163-037-11	CERAMIC CHIP 0.022MF	10% 25V	C326	1-124-903-11	ELECT 1MF 20%	50V
C059	1-163-125-00	CERAMIC CHIP 220PF	5% 50V	C327	1-102-244-00	CERAMIC 220PF	10% 500V
C060	1-124-903-11	ELECT 1MF	20% 50V	C328	1-124-902-00	ELECT 0.47MF	20% 50V
C062	1-124-907-11	ELECT 10MF	20% 50V	C329	1-124-925-11	ELECT 2.2MF	20% 50V
C064	1-124-122-11	ELECT 100MF	20% 50V	C330	1-163-007-11	CERAMIC CHIP 680PF	10% 50V
C066	1-124-903-11	ELECT 1MF	20% 50V	C332	1-136-169-00	FILM 0.22MF	5% 50V
C068	1-124-927-11	ELECT 4.7MF	20% 50V	C333	1-136-169-00	FILM 0.22MF	5% 50V
C101	1-124-907-11	ELECT 10MF	20% 50V	C334	1-163-037-11	CERAMIC CHIP 0.022MF	10% 25V
C201	1-124-120-11	ELECT 220MF	20% 16V	C335	1-124-903-11	ELECT 1MF	20% 50V
C202	1-124-907-11	ELECT 10MF	20% 50V	C336	1-124-907-11	ELECT 10MF	20% 50V
C203	1-124-477-11	ELECT 47MF	20% 16V	C340	1-126-101-11	ELECT 100MF	20% 16V
C204	1-126-101-11	ELECT 100MF	20% 16V	C341	1-124-903-11	ELECT 1MF	20% 50V
C206	1-163-009-11	CERAMIC CHIP 0.001MF	10% 50V	C342	1-163-033-00	CERAMIC CHIP 0.022MF	50V
				C345	1-124-477-11	ELECT 47MF	20% 16V
				C347	1-126-101-11	ELECT 100MF	20% 16V
				C403	1-124-907-11	ELECT 10MF	20% 50V
				C404	1-124-903-11	ELECT 1MF	20% 50V

Les composants identifiés par une
 trame et une marque **Δ** sont
 critiques pour la sécurité.
 Ne les remplacer que par une pièce
 portant le numéro spécifié.

The components identified by
 shading and mark **Δ** are critical
 for safety.
 Replace only with part number
 specified.

A (KV-20TS29/21STR2/2170RS)

REF. NO.	PART NO.	DESCRIPTION	REMARK	REF. NO.	PART NO.	DESCRIPTION	REMARK
C405	1-124-903-11	ELECT	1MF 20% 50V	CN201	*1-564-505-11	PLUG, CONNECTOR 2P	
C413	1-124-907-11	ELECT	10MF 20% 50V	CN202	*1-564-505-11	PLUG, CONNECTOR 2P	
C418	1-124-903-11	ELECT	1MF 20% 50V	CN203	*1-560-123-00	PLUG, CONNECTOR (2.5MM) 3P	
C419	1-124-903-11	ELECT	1MF 20% 50V	CN301	*1-564-509-11	PLUG, CONNECTOR 6P	
C420	1-124-907-11	ELECT	10MF 20% 50V	CN501	*1-580-798-11	CONNECTOR PIN (DY) 6P	
C421	1-124-907-11	ELECT	10MF 20% 50V	CN502	*1-508-768-00	PIN, CONNECTOR (5MM PITCH) 6P	
C422	1-126-103-11	ELECT	470MF 20% 16V	CN651	*1-691-135-11	PIN, CONNECTOR (PC BOARD) 4P	
C423	1-124-907-11	ELECT	10MF 20% 50V	CN652	*1-564-510-11	PLUG, CONNECTOR 7P	
C424	1-124-925-11	ELECT	2.2MF 20% 50V				
C425	1-124-925-11	ELECT	2.2MF 20% 50V				
C440	1-126-101-11	ELECT	100MF 20% 16V				
C461	1-124-907-11	ELECT	10MF 20% 50V				
C501	1-124-902-00	ELECT	0.47MF 20% 50V				
C502	1-124-916-11	ELECT	22MF 20% 50V				
C504	1-130-489-00	FILM	0.033MF 5% 50V				
C505	1-164-058-11	CERAMIC	33PF 5% 50V				
C506	1-124-916-11	ELECT	22MF 20% 50V				
C507	1-102-038-00	CERAMIC	0.001MF 500V				
C508	1-102-038-00	CERAMIC	0.001MF 500V				
C509	1-124-122-11	ELECT	100MF 20% 35V				
C510	1-137-421-91	FILM	0.068MF 10% 100V				
C511	Δ 1-108-421-91	MYLAR	0.01MF 10% 200V				
C512	1-164-096-11	CERAMIC	0.01MF 50V				
C513	1-124-903-11	ELECT	1MF 20% 50V				
C514	1-124-903-11	ELECT	1MF 20% 50V				
C515	1-124-480-11	ELECT	470MF 20% 25V				
C516	1-102-244-00	CERAMIC	220PF 10% 500V				
C517	1-162-114-00	CERAMIC	0.0047MF 2KV				
C518	1-124-480-11	ELECT	470MF 20% 25V				
C519	1-102-244-00	CERAMIC	220PF 10% 500V				
C520	1-124-046-00	ELECT	10MF 20% 160V				
C521	1-102-244-00	CERAMIC	220PF 10% 500V				
C522	1-123-024-21	ELECT	33MF 160V				
C523	1-123-932-00	ELECT	4.7MF 20% 160V				
C524	1-124-477-11	ELECT	47MF 20% 16V				
C525	1-106-387-00	MYLAR	0.068MF 10% 200V				
C526	1-124-916-11	ELECT	22MF 20% 25V				
C528	1-124-046-00	ELECT	10MF 20% 160V				
C553	1-102-228-00	CERAMIC	470PF 10% 500V				
C554	Δ 1-162-134-91	CERAMIC	470PF 10% 2KV				
C555	Δ 1-104-750-91	FILM	0.033MF 5% 400V				
C556	Δ 1-136-080-11	FILM	0.011MF 3% 2KV				
C557	1-162-116-00	CERAMIC	680PF 10% 2KV				
C558	1-137-417-91	FILM	0.015MF 10% 100V				
C559	1-162-116-00	CERAMIC	680PF 10% 2KV				
C562	1-102-228-00	CERAMIC	470PF 10% 500V				
C564	1-136-111-00	FILM	1MF 5% 200V				
C568	1-124-634-11	ELECT	1MF 20% 250V				
C571	1-124-927-11	ELECT	4.7MF 20% 50V				
C574	1-136-569-11	FILM	1.2MF 5% 200V				
C575	1-106-371-00	MYLAR	0.015MF 200V				
C590	1-163-009-11	CERAMIC CHIP	0.001MF 10% 50V				
C682	1-124-477-11	ELECT	47MF 20% 16V				
C683	1-124-478-11	ELECT	100MF 20% 25V				
C684	1-124-477-11	ELECT	47MF 20% 16V				
C686	1-124-477-11	ELECT	47MF 20% 16V				
C690	1-124-902-00	ELECT	0.47MF 20% 50V				
C691	1-124-120-11	ELECT	220MF 20% 25V				
C692	1-124-477-11	ELECT	47MF 20% 16V				
		<CONNECTOR>					
CN101	*1-573-978-11	CONNECTOR, BOARD TO BOARD 11P					
CN102	*1-560-124-00	PLUG, CONNECTOR (2.5MM) 4P					
		<DIODE>					
D002	8-719-911-19	DIODE 1SS119					
D003	8-719-911-19	DIODE 1SS119					
D004	8-719-911-19	DIODE 1SS119					
D005	8-713-300-57	DIODE 1T33					
D006	8-719-911-19	DIODE 1SS119					
D009	8-719-911-19	DIODE 1SS119					
D101	1-810-039-11	LED UNIT					
D201	8-719-110-72	DIODE RD30ES-B2					
D251	8-719-911-19	DIODE 1SS119					
D252	8-719-911-19	DIODE 1SS119					
D302	8-719-109-84	DIODE RD5.1ES-B1					
D403	8-719-110-36	DIODE RD13ES-B2					
D404	8-719-110-36	DIODE RD13ES-B2					
D405	8-719-110-36	DIODE RD13ES-B2					
D418	8-719-936-82	DIODE GP08DPKG3					
D501	8-719-911-19	DIODE 1SS119					
D502	8-719-936-82	DIODE GP08DPKG3					
D504	8-719-936-84	DIODE RGP10GPKG3					
D507	8-719-911-19	DIODE 1SS119					
D509	8-719-936-84	DIODE RGP10GPKG3					
D511	Δ 8-719-302-43	DIODE EL1Z					
D512	8-719-936-84	DIODE RGP10GPKG3					
D513	8-719-976-64	DIODE RGP02-17					
D551	8-719-979-85	DIODE EGP20G					
D552	8-719-945-80	DIODE ERC06-15S					
D681	8-719-109-90	DIODE RD5.6ES-B3					
		<IC>					
IC101	8-752-841-16	IC CXP80424-0655					
IC102	8-759-043-86	IC ST24C02AB1					
IC103	8-741-100-62	IC SBX1618-51					
IC251	8-759-980-43	IC TDA2009A					
IC301	8-745-059-67	IC CXA1465AS					
IC401	8-759-634-69	IC M52470P					
IC404	8-759-069-14	IC M51132L					
IC501	8-759-801-98	IC LA7830					
IC502	8-759-996-43	IC RC4558PS					
IC681	8-759-701-79	IC NJM7812FA					
IC682	8-759-982-10	IC RC7809FA					
IC690	8-759-805-37	IC L78LR05D-MA					
		<JACK>					
J402	1-750-278-11	JACK BLOCK, PIN 3P					
		<COIL>					
L001	1-410-470-11	INDUCTOR 10UH					
L002	1-410-476-11	INDUCTOR 33UH					
L003	1-410-470-11	INDUCTOR 10UH					
L201	1-410-645-31	INDUCTOR 100UH					
L202	1-408-408-00	INDUCTOR 8.2UH					

The components identified by shading and mark **▲** are critical for safety. Replace only with part number specified.

Les composants identifiés par une trame et une marque **▲** sont critiques pour la sécurité. Ne les remplacer que par une pièce portant le numéro spécifié.

A (KV-20TS29/21STR2/2170RS)

REF. NO.	PART NO.	DESCRIPTION	REMARK	REF. NO.	PART NO.	DESCRIPTION	REMARK
L502	1-410-669-31	INDUCTOR 33UH		R032	1-216-025-00	METAL GLAZE 100 5%	1/10W
L503 ▲	1-412-531-61	INDUCTOR 33UH		R033	1-216-025-00	METAL GLAZE 100 5%	1/10W
L551	1-412-533-61	INDUCTOR 47UH		R034	1-216-025-00	METAL GLAZE 100 5%	1/10W
L555	1-422-613-11	COIL, AIR CORE		R035	1-216-041-00	METAL GLAZE 470 5%	1/10W
L556 ▲	1-459-769-13	COIL, HORIZONTAL LINEARITY		R036	1-216-033-00	METAL GLAZE 220 5%	1/10W
L557	1-412-553-61	INDUCTOR 3.3MMH		R037	1-216-033-00	METAL GLAZE 220 5%	1/10W
L560	1-459-104-00	COIL, WITH CORE		R038	1-216-033-00	METAL GLAZE 220 5%	1/10W
L561 ▲	1-459-390-31	COIL (WITH CORE)		R040	1-216-033-00	METAL GLAZE 220 5%	1/10W
<MODULE>				R041	1-216-033-00	METAL GLAZE 220 5%	1/10W
PM501	1-810-040-11	PROTECTOR MODULE PM-35		R042	1-216-295-00	METAL GLAZE 0 5%	1/10W
<IC LINK>				R043	1-216-295-00	METAL GLAZE 0 5%	1/10W
PS201 ▲	1-532-675-91	LINK, IC 1.5A		R044	1-216-065-00	METAL GLAZE 4.7K 5%	1/10W
<TRANSISTOR>				R045	1-216-065-00	METAL GLAZE 4.7K 5%	1/10W
Q001	8-729-422-36	TRANSISTOR 2SB709A-Q		R046	1-216-065-00	METAL GLAZE 4.7K 5%	1/10W
Q004	8-729-422-36	TRANSISTOR 2SB709A-Q		R047	1-216-049-00	METAL GLAZE 1K 5%	1/10W
Q005	8-729-422-27	TRANSISTOR 2SD601A-Q		R048	1-216-073-00	METAL GLAZE 10K 5%	1/10W
Q007	8-729-422-27	TRANSISTOR 2SD601A-Q		R049	1-216-025-00	METAL GLAZE 100 5%	1/10W
Q261	8-729-422-36	TRANSISTOR 2SB709A-Q		R050	1-216-049-00	METAL GLAZE 1K 5%	1/10W
Q262	8-729-422-27	TRANSISTOR 2SD601A-Q		R051	1-216-073-00	METAL GLAZE 10K 5%	1/10W
Q301	8-729-422-36	TRANSISTOR 2SB709A-Q		R052	1-216-065-00	METAL GLAZE 4.7K 5%	1/10W
Q309	8-729-422-27	TRANSISTOR 2SD601A-Q		R054	1-216-049-00	METAL GLAZE 1K 5%	1/10W
Q310	8-729-422-27	TRANSISTOR 2SD601A-Q		R055	1-216-073-00	METAL GLAZE 10K 5%	1/10W
Q311	8-729-422-27	TRANSISTOR 2SD601A-Q		R056	1-216-065-00	METAL GLAZE 4.7K 5%	1/10W
Q401	8-729-422-36	TRANSISTOR 2SB709A-Q		R057	1-216-065-00	METAL GLAZE 4.7K 5%	1/10W
Q402	8-729-422-36	TRANSISTOR 2SB709A-Q		R059	1-216-065-00	METAL GLAZE 4.7K 5%	1/10W
Q501	8-729-422-27	TRANSISTOR 2SD601A-Q		R061	1-216-065-00	METAL GLAZE 4.7K 5%	1/10W
Q550	8-729-140-50	TRANSISTOR 2SC3209LK		R062	1-216-069-00	METAL GLAZE 6.8K 5%	1/10W
Q551	8-729-821-87	TRANSISTOR 2SD1878-CA		R063	1-216-065-00	METAL GLAZE 4.7K 5%	1/10W
Q553	8-729-019-01	TRANSISTOR 2SD2394-EF		R064	1-216-065-00	METAL GLAZE 4.7K 5%	1/10W
Q681	8-729-378-84	TRANSISTOR 2SD788-5		R065	1-216-065-00	METAL GLAZE 4.7K 5%	1/10W
<RESISTOR>				R066	1-216-295-00	METAL GLAZE 0 5%	1/10W
R001	1-216-073-00	METAL GLAZE 10K 5%	1/10W	R067	1-216-295-00	METAL GLAZE 0 5%	1/10W
R003	1-216-045-00	METAL GLAZE 680 5%	1/10W	R069	1-216-295-00	METAL GLAZE 0 5%	1/10W
R004	1-216-033-00	METAL GLAZE 220 5%	1/10W	R071	1-216-047-00	METAL GLAZE 820 5%	1/10W
R005	1-216-033-00	METAL GLAZE 220 5%	1/10W	R073	1-216-079-00	METAL GLAZE 18K 5%	1/10W
R006	1-216-073-00	METAL GLAZE 10K 5%	1/10W	R074	1-216-049-00	METAL GLAZE 1K 5%	1/10W
R008	1-216-033-00	METAL GLAZE 220 5%	1/10W	R075	1-216-073-00	METAL GLAZE 10K 5%	1/10W
R009	1-216-057-00	METAL GLAZE 2.2K 5%	1/10W	R078	1-249-429-11	CARBON 10K 5%	1/4W
R010	1-216-033-00	METAL GLAZE 220 5%	1/10W	R079	1-216-295-00	METAL GLAZE 0 5%	1/10W
R011	1-216-033-00	METAL GLAZE 220 5%	1/10W	R080	1-216-073-00	METAL GLAZE 10K 5%	1/10W
R012	1-216-033-00	METAL GLAZE 220 5%	1/10W	R081	1-216-073-00	METAL GLAZE 10K 5%	1/10W
R016	1-216-033-00	METAL GLAZE 220 5%	1/10W	R082	1-216-055-00	METAL GLAZE 1.8K 5%	1/10W
R017	1-216-033-00	METAL GLAZE 220 5%	1/10W	R083	1-249-437-11	CARBON 47K 5%	1/4W
R018	1-216-033-00	METAL GLAZE 220 5%	1/10W	R084	1-216-093-00	METAL GLAZE 68K 5%	1/10W
R019	1-216-061-00	METAL GLAZE 3.3K 5%	1/10W	R085	1-216-065-00	METAL GLAZE 4.7K 5%	1/10W
R020	1-216-073-00	METAL GLAZE 10K 5%	1/10W	R086	1-216-295-00	METAL GLAZE 0 5%	1/10W
R021	1-216-073-00	METAL GLAZE 10K 5%	1/10W	R088	1-216-089-00	METAL GLAZE 47K 5%	1/10W
R022	1-216-073-00	METAL GLAZE 10K 5%	1/10W	R089	1-216-041-00	METAL GLAZE 470 5%	1/10W
R023	1-216-033-00	METAL GLAZE 220 5%	1/10W	R091	1-216-089-00	METAL GLAZE 47K 5%	1/10W
R025	1-216-039-00	METAL GLAZE 390 5%	1/10W	R092	1-216-073-00	METAL GLAZE 10K 5%	1/10W
R026	1-216-097-00	METAL GLAZE 100K 5%	1/10W	R093	1-216-049-00	METAL GLAZE 1K 5%	1/10W
R027	1-216-121-00	METAL GLAZE 1M 5%	1/10W	R095	1-216-033-00	METAL GLAZE 220 5%	1/10W
R028	1-216-073-00	METAL GLAZE 10K 5%	1/10W	R096	1-216-033-00	METAL GLAZE 220 5%	1/10W
R029	1-216-065-00	METAL GLAZE 4.7K 5%	1/10W	R097	1-216-033-00	METAL GLAZE 220 5%	1/10W
R030	1-216-073-00	METAL GLAZE 10K 5%	1/10W	R101	1-216-073-00	METAL GLAZE 10K 5%	1/10W
R031	1-216-025-00	METAL GLAZE 100 5%	1/10W	R102	1-216-039-00	METAL GLAZE 390 5%	1/10W
				R203	1-215-924-00	METAL OXIDE 15K 5%	3W F
				R206	1-216-689-11	METAL GLAZE 39K 5%	1/10W
				R207	1-216-083-00	METAL GLAZE 27K 5%	1/10W
				R251	1-216-059-00	METAL GLAZE 2.7K 5%	1/10W
				R252	1-216-059-00	METAL GLAZE 2.7K 5%	1/10W
				R253	1-216-061-00	METAL GLAZE 3.3K 5%	1/10W
				R254	1-216-015-00	METAL GLAZE 39 5%	1/10W

The components identified by **■** in this manual have been carefully factory-selected for each set in order to satisfy regulations regarding X-ray radiation.
 Should replacement be required, replace only with the value originally used.

Les composants identifiés par une trame et une marque **▲** sont critiques pour la sécurité. Ne les remplacer que par une pièce portant le numéro spécifié.

The components identified by shading and mark **▲** are critical for safety. Replace only with part number specified.

A (KV-20TS29/21STR2/2170RS)

REF. NO.	PART NO.	DESCRIPTION	REMARK
R256	1-216-015-00	METAL GLAZE 39 5% 1/10W	
R257	1-216-061-00	METAL GLAZE 3.3K 5% 1/10W	
R258	1-216-051-00	METAL GLAZE 1.2K 5% 1/10W	
R259	1-216-051-00	METAL GLAZE 1.2K 5% 1/10W	
R262	1-216-075-00	METAL GLAZE 12K 5% 1/10W	
R263	1-216-075-00	METAL GLAZE 12K 5% 1/10W	
R264	1-216-041-00	METAL GLAZE 470 5% 1/10W	
R265	1-216-085-00	METAL GLAZE 33K 5% 1/10W	
R266	1-216-085-00	METAL GLAZE 33K 5% 1/10W	
R267	1-216-089-00	METAL GLAZE 47K 5% 1/10W	
R268	1-216-065-00	METAL GLAZE 4.7K 5% 1/10W	
R269	1-249-385-11	CARBON 2.2 5% 1/4W	
R270	1-249-385-11	CARBON 2.2 5% 1/4W	
R301	1-216-065-00	METAL GLAZE 4.7K 5% 1/10W	
R302	1-216-057-00	METAL GLAZE 2.2K 5% 1/10W	
R311	1-216-678-11	METAL CHIP 13K 0.50% 1/10W	
R312	1-216-079-00	METAL GLAZE 18K 5% 1/10W	
R313	1-216-653-11	METAL CHIP 1.2K 0.50% 1/10W	
R314	1-216-117-00	METAL GLAZE 680K 5% 1/10W	
R315	1-216-051-00	METAL GLAZE 1.2K 5% 1/10W	
R319	1-216-295-00	METAL GLAZE 0 5% 1/10W	
R320	1-216-295-00	METAL GLAZE 0 5% 1/10W	
R321	1-216-295-00	METAL GLAZE 0 5% 1/10W	
R322	1-216-295-00	METAL GLAZE 0 5% 1/10W	
R323	1-216-121-00	METAL GLAZE 1M 5% 1/10W	
R324	1-216-025-00	METAL GLAZE 100 5% 1/10W	
R326	1-216-025-00	METAL GLAZE 100 5% 1/10W	
R327	1-216-077-00	METAL GLAZE 15K 5% 1/10W	
R328	1-216-025-00	METAL GLAZE 100 5% 1/10W	
R329	1-216-073-00	METAL GLAZE 10K 5% 1/10W	
R330	1-216-067-00	METAL GLAZE 5.6K 5% 1/10W	
R331	1-216-093-00	METAL GLAZE 68K 5% 1/10W	
R335	1-216-049-00	METAL GLAZE 1K 5% 1/10W	
R336	1-216-121-00	METAL GLAZE 1M 5% 1/10W	
R338	1-216-049-00	METAL GLAZE 1K 5% 1/10W	
R339	1-216-045-00	METAL GLAZE 680 5% 1/10W	
R341	1-216-687-11	METAL CHIP 33K 0.50% 1/10W	
R343	1-216-071-00	METAL GLAZE 8.2K 5% 1/10W	
R345	1-249-429-11	CARBON 10K 5% 1/4W	
R346	1-249-421-11	CARBON 2.2K 5% 1/4W	
R347	1-216-025-00	METAL GLAZE 100 5% 1/10W	
R351	1-216-085-00	METAL GLAZE 33K 5% 1/10W	
R356	1-216-049-00	METAL GLAZE 1K 5% 1/10W	
R357	1-216-089-00	METAL GLAZE 47K 5% 1/10W	
R358	1-216-091-00	METAL GLAZE 56K 5% 1/10W	
R360	1-216-041-00	METAL GLAZE 470 5% 1/10W	
R361	1-216-025-00	METAL GLAZE 100 5% 1/10W	
R362	1-216-295-00	METAL GLAZE 0 5% 1/10W	
R363	1-216-295-00	METAL GLAZE 0 5% 1/10W	
R364	1-216-295-00	METAL GLAZE 0 5% 1/10W	
R365	1-216-049-00	METAL GLAZE 1K 5% 1/10W	
R367	1-216-109-00	METAL GLAZE 330K 5% 1/10W	
R403	1-216-022-00	METAL GLAZE 75 5% 1/10W	
R404	1-216-295-00	METAL GLAZE 0 5% 1/10W	
R405	1-216-113-00	METAL GLAZE 470K 5% 1/10W	
R406	1-216-113-00	METAL GLAZE 470K 5% 1/10W	
R413	1-216-295-00	METAL GLAZE 0 5% 1/10W	
R414	1-216-041-00	METAL GLAZE 470 5% 1/10W	
R415	1-216-041-00	METAL GLAZE 470 5% 1/10W	
R429	1-216-295-00	METAL GLAZE 0 5% 1/10W	
R430	1-216-295-00	METAL GLAZE 0 5% 1/10W	
R441	1-216-073-00	METAL GLAZE 10K 5% 1/10W	
R443	1-216-073-00	METAL GLAZE 10K 5% 1/10W	
R444	1-216-049-00	METAL GLAZE 1K 5% 1/10W	

REF. NO.	PART NO.	DESCRIPTION	REMARK
R445	1-216-049-00	METAL GLAZE 1K 5% 1/10W	
R448	1-249-417-11	CARBON 1K 5% 1/4W	
R449	1-216-049-00	METAL GLAZE 1K 5% 1/10W	
R450	1-216-025-00	METAL GLAZE 100 5% 1/10W	
R453	1-216-049-00	METAL GLAZE 1K 5% 1/10W	
R454	1-216-049-00	METAL GLAZE 1K 5% 1/10W	
R456	1-216-295-00	METAL GLAZE 0 5% 1/10W	
R457	1-216-295-00	METAL GLAZE 0 5% 1/10W	
R458	1-216-073-00	METAL GLAZE 10K 5% 1/10W	
R459	1-216-295-00	METAL GLAZE 0 5% 1/10W	
R460	1-216-295-00	METAL GLAZE 0 5% 1/10W	
R469	1-216-073-00	METAL GLAZE 10K 5% 1/10W	
R471	1-216-295-00	METAL GLAZE 0 5% 1/10W	
R472	1-216-049-00	METAL GLAZE 1K 5% 1/10W	
R473	1-216-025-00	METAL GLAZE 100 5% 1/10W	
R474	1-216-295-00	METAL GLAZE 0 5% 1/10W	
R475	1-216-025-00	METAL GLAZE 100 5% 1/10W	
R501	1-249-429-11	CARBON 10K 5% 1/4W	
R502	1-216-073-00	METAL GLAZE 10K 5% 1/10W	
R505	1-216-349-00	METAL OXIDE 1 5% 1W F	
R506	1-216-429-00	METAL OXIDE 270 5% 1W F	
R507	1-247-887-00	CARBON 220K 5% 1/4W	
R508	1-216-049-00	METAL GLAZE 1K 5% 1/10W	
R509	1-216-101-00	METAL GLAZE 150K 5% 1/10W	
R510	1-216-055-00	METAL GLAZE 1.8K 5% 1/10W	
■R511 ▲		METAL 1/4W	
R512	1-215-445-00	METAL 10K 1% 1/4W	
R513	1-216-645-11	METAL CHIP 560 0.50% 1/10W	
R515	1-216-673-11	METAL CHIP 8.2K 0.50% 1/10W	
R517	1-216-699-11	METAL CHIP 100K 0.50% 1/10W	
R518	1-215-431-00	METAL 2.7K 1% 1/4W	
R519	1-215-427-00	METAL 1.8K 1% 1/4W	
R520	1-216-073-00	METAL GLAZE 10K 5% 1/10W	
R530	1-249-419-11	CARBON 1.5K 5% 1/4W	
R531	1-216-357-00	METAL OXIDE 4.7 5% 1W F	
■R532 ▲	1-215-880-91	METAL OXIDE 10 5% 2W F	
R533	1-216-359-00	METAL OXIDE 6.8 5% 1W F	
R534	1-249-393-11	CARBON 10 5% 1/4W F	
R535	1-249-389-11	CARBON 4.7 5% 1/4W F	
■R537 ▲		METAL 1/4W	
R538	1-249-441-11	CARBON 100K 5% 1/4W	
R541	1-249-418-11	CARBON 1.2K 5% 1/4W F	
R542	1-216-357-00	METAL OXIDE 4.7 5% 1W F	
R549	1-216-369-00	METAL OXIDE 1 5% 2W F	
R554	1-216-061-00	METAL GLAZE 3.3K 5% 1/10W	
R555	1-215-896-00	METAL OXIDE 4.7K 5% 2W F	
R558	1-249-415-11	CARBON 680 5% 1/4W F	
R559	1-215-862-11	METAL OXIDE 68 5% 1W F	
R565	1-249-377-11	CARBON 0.47 5% 1/4W F	
R566	1-249-417-11	CARBON 1K 5% 1/4W F	
R588	1-216-105-00	METAL GLAZE 220K 5% 1/10W	
R590	1-216-063-00	METAL GLAZE 3.9K 5% 1/10W	
R591	1-216-061-00	METAL GLAZE 3.3K 5% 1/10W	
R592	1-216-073-00	METAL GLAZE 10K 5% 1/10W	
R593	1-216-049-00	METAL GLAZE 1K 5% 1/10W	
R594	1-216-689-11	METAL GLAZE 39K 5% 1/10W	
R595	1-216-073-00	METAL GLAZE 10K 5% 1/10W	
R599	1-215-857-11	METAL OXIDE 10 5% 1W F	
R681	1-215-883-11	METAL OXIDE 33 5% 2W F	
R682	1-249-415-11	CARBON 680 5% 1/4W F	
R683	1-216-356-00	METAL OXIDE 3.9 5% 1W F	
R684	1-216-380-11	METAL OXIDE 8.2 5% 2W F	

The components identified by shading and mark **Δ** are critical for safety. Replace only with part number specified.

Les composants identifiés par une trame et une marque **Δ** sont critiques pour la sécurité. Ne les remplacer que par une pièce portant le numéro spécifié.

A (KV-20TS29/21STR2/2170RS)

A (KV-20TS32)

REF. NO.	PART NO.	DESCRIPTION	REMARK
<SWITCH>			
S001	1-571-532-21	SWITCH, TACTIL	
S002	1-571-532-21	SWITCH, TACTIL	
S003	1-571-532-21	SWITCH, TACTIL	
S004	1-571-532-21	SWITCH, TACTIL	
S005	1-571-532-21	SWITCH, TACTIL	
S006	1-571-532-21	SWITCH, TACTIL	
<SPARK GAP>			
SG551	1-519-422-11	GAP, SPARK	
<TRANSFORMER>			
T504	1-453-141-11	TRANSFORMER ASSY, FLYBACK (NX-1600A5)	
T551	1-437-195-11	TRANSFORMER, HORIZONTAL DRIVE	
<TUNER>			
TU101	1-598-039-01	TUNER BTF-WA401	
<CRYSTAL>			
X001	1-579-917-21	VIBRATOR, CRYSTAL	
X301	1-567-505-11	OSCILLATOR, CRYSTAL	

*A-1297-058-A	A BOARD, COMPLETE (KV-20TS32)		

4-382-854-11	SCREW (M3X10), P, SW (+)		
<CAPACITOR>			
C002	1-163-809-11	CERAMIC CHIP 0.047MF	10% 25V
C003	1-163-125-00	CERAMIC CHIP 220PF	5% 50V
C007	1-124-903-11	ELECT 1MF	20% 50V
C011	1-163-009-11	CERAMIC CHIP 0.001MF	10% 50V
C012	1-163-009-11	CERAMIC CHIP 0.001MF	10% 50V
C013	1-163-009-11	CERAMIC CHIP 0.001MF	10% 50V
C014	1-163-009-11	CERAMIC CHIP 0.001MF	10% 50V
C015	1-163-009-11	CERAMIC CHIP 0.001MF	10% 50V
C016	1-163-009-11	CERAMIC CHIP 0.001MF	10% 50V
C017	1-163-009-11	CERAMIC CHIP 0.001MF	10% 50V
C018	1-163-009-11	CERAMIC CHIP 0.001MF	10% 50V
C019	1-163-009-11	CERAMIC CHIP 0.001MF	10% 50V
C020	1-163-009-11	CERAMIC CHIP 0.001MF	10% 50V
C030	1-163-125-00	CERAMIC CHIP 220PF	5% 50V
C039	1-163-125-00	CERAMIC CHIP 220PF	5% 50V
C040	1-163-125-00	CERAMIC CHIP 220PF	5% 50V
C041	1-163-009-11	CERAMIC CHIP 0.001MF	10% 50V
C043	1-163-159-00	CERAMIC CHIP 12PF	2% 50V
C045	1-126-103-11	ELECT 470MF	20% 16V
C046	1-163-017-00	CERAMIC CHIP 0.0047MF	10% 50V
C047	1-104-896-91	CERAMIC CHIP 24PF	2% 50V
C048	1-216-049-00	METAL GLAZE 1K	5% 1/10W
C049	1-163-125-00	CERAMIC CHIP 220PF	5% 50V
C050	1-163-109-00	CERAMIC CHIP 47PF	5% 50V
C051	1-163-125-00	CERAMIC CHIP 220PF	5% 50V
C052	1-163-125-00	CERAMIC CHIP 220PF	5% 50V
C053	1-163-121-00	CERAMIC CHIP 150PF	5% 50V
C054	1-163-253-11	CERAMIC CHIP 120PF	5% 50V

REF. NO.	PART NO.	DESCRIPTION	REMARK
C055	1-163-125-00	CERAMIC CHIP 220PF	5% 50V
C056	1-163-125-00	CERAMIC CHIP 220PF	5% 50V
C057	1-163-125-00	CERAMIC CHIP 220PF	5% 50V
C058	1-163-037-11	CERAMIC CHIP 0.022MF	10% 25V
C059	1-163-125-00	CERAMIC CHIP 220PF	5% 50V
C060	1-124-903-11	ELECT 1MF	20% 50V
C062	1-124-907-11	ELECT 10MF	20% 50V
C064	1-124-122-11	ELECT 100MF	20% 50V
C066	1-124-903-11	ELECT 1MF	20% 50V
C068	1-124-927-11	ELECT 4.7MF	20% 50V
C101	1-124-907-11	ELECT 10MF	20% 50V
C201	1-124-120-11	ELECT 220MF	20% 16V
C202	1-124-907-11	ELECT 10MF	20% 50V
C203	1-124-477-11	ELECT 47MF	20% 16V
C204	1-126-101-11	ELECT 100MF	20% 16V
C206	1-163-009-11	CERAMIC CHIP 0.001MF	10% 50V
C251	1-124-925-11	ELECT 2.2MF	20% 50V
C254	1-126-101-11	ELECT 100MF	20% 16V
C255	1-124-916-11	ELECT 22MF	20% 25V
C256	1-126-101-11	ELECT 100MF	20% 16V
C257	1-124-925-11	ELECT 2.2MF	20% 50V
C258	1-136-169-00	FILM 0.22MF	5% 50V
C259	1-136-173-00	FILM 0.47MF	5% 50V
C260	1-124-907-11	ELECT 10MF	20% 50V
C261	1-124-556-11	ELECT 2200MF	20% 16V
C262	1-124-925-11	ELECT 2.2MF	20% 50V
C263	1-136-169-00	FILM 0.22MF	5% 50V
C270	1-124-907-11	ELECT 10MF	20% 50V
C271	1-124-907-11	ELECT 10MF	20% 50V
C272	1-126-103-11	ELECT 470MF	20% 16V
C273	1-126-103-11	ELECT 470MF	20% 16V
C301	1-163-113-00	CERAMIC CHIP 68PF	5% 50V
C304	1-124-907-11	ELECT 10MF	20% 50V
C305	1-124-903-11	ELECT 1MF	20% 50V
C306	1-163-035-00	CERAMIC CHIP 0.047MF	50V
C307	1-163-125-00	CERAMIC CHIP 220PF	5% 50V
C308	1-124-902-00	ELECT 0.47MF	20% 50V
C309	1-163-099-00	CERAMIC CHIP 18PF	5% 50V
C310	1-124-916-11	ELECT 22MF	20% 25V
C311	1-137-399-11	FILM 0.1MF	5% 50V
C312	1-137-399-11	FILM 0.1MF	5% 50V
C313	1-137-399-11	FILM 0.1MF	5% 50V
C314	1-163-037-11	CERAMIC CHIP 0.022MF	10% 25V
C315	1-124-120-11	ELECT 220MF	20% 16V
C318	1-163-117-00	CERAMIC CHIP 100PF	5% 50V
C319	1-124-902-00	ELECT 0.47MF	20% 50V
C320	1-163-017-00	CERAMIC CHIP 0.0047MF	10% 50V
C321	1-163-005-11	CERAMIC CHIP 470PF	10% 50V
C322	1-163-011-11	CERAMIC CHIP 0.0015MF	10% 50V
C323	1-163-007-11	CERAMIC CHIP 680PF	10% 50V
C324	1-124-903-11	ELECT 1MF	20% 50V
C325	1-164-232-11	CERAMIC CHIP 0.01MF	10% 50V
C326	1-124-903-11	ELECT 1MF	20% 50V
C327	1-102-244-00	CERAMIC 220PF	10% 500V
C328	1-124-902-00	ELECT 0.47MF	20% 50V
C329	1-124-925-11	ELECT 2.2MF	20% 50V
C330	1-163-007-11	CERAMIC CHIP 680PF	10% 50V
C332	1-136-169-00	FILM 0.22MF	5% 50V
C333	1-136-169-00	FILM 0.22MF	5% 50V
C334	1-163-037-11	CERAMIC CHIP 0.022MF	10% 25V
C335	1-124-903-11	ELECT 1MF	20% 50V
C336	1-124-907-11	ELECT 10MF	20% 50V
C340	1-126-101-11	ELECT 100MF	20% 16V

A (KV-20TS32)

REF. NO.	PART NO.	DESCRIPTION	REMARK	REF. NO.	PART NO.	DESCRIPTION	REMARK
R074	1-216-049-00	METAL GLAZE 1K 5%	1/10W	R335	1-216-049-00	METAL GLAZE 1K 5%	1/10W
R075	1-216-073-00	METAL GLAZE 10K 5%	1/10W	R336	1-216-121-00	METAL GLAZE 1M 5%	1/10W
R078	1-249-429-11	CARBON 10K 5%	1/4W	R338	1-216-049-00	METAL GLAZE 1K 5%	1/10W
R079	1-216-295-00	METAL GLAZE 0 5%	1/10W	R339	1-216-045-00	METAL GLAZE 680 5%	1/10W
R080	1-216-073-00	METAL GLAZE 10K 5%	1/10W	R341	1-216-687-11	METAL CHIP 33K 0.50%	1/10W
R081	1-216-073-00	METAL GLAZE 10K 5%	1/10W	R343	1-216-071-00	METAL GLAZE 8.2K 5%	1/10W
R082	1-216-055-00	METAL GLAZE 1.8K 5%	1/10W	R345	1-249-429-11	CARBON 10K 5%	1/4W
R083	1-249-437-11	CARBON 47K 5%	1/4W	R346	1-249-421-11	CARBON 2.2K 5%	1/4W
R084	1-216-093-00	METAL GLAZE 68K 5%	1/10W	R347	1-216-025-00	METAL GLAZE 100 5%	1/10W
R085	1-216-065-00	METAL GLAZE 4.7K 5%	1/10W	R351	1-216-085-00	METAL GLAZE 33K 5%	1/10W
R086	1-216-295-00	METAL GLAZE 0 5%	1/10W	R356	1-216-049-00	METAL GLAZE 1K 5%	1/10W
R088	1-216-089-00	METAL GLAZE 47K 5%	1/10W	R357	1-216-089-00	METAL GLAZE 47K 5%	1/10W
R089	1-216-041-00	METAL GLAZE 470 5%	1/10W	R358	1-216-091-00	METAL GLAZE 56K 5%	1/10W
R091	1-216-089-00	METAL GLAZE 47K 5%	1/10W	R360	1-216-041-00	METAL GLAZE 470 5%	1/10W
R092	1-216-073-00	METAL GLAZE 10K 5%	1/10W	R361	1-216-025-00	METAL GLAZE 100 5%	1/10W
R093	1-216-049-00	METAL GLAZE 1K 5%	1/10W	R362	1-216-295-00	METAL GLAZE 0 5%	1/10W
R095	1-216-033-00	METAL GLAZE 220 5%	1/10W	R363	1-216-295-00	METAL GLAZE 0 5%	1/10W
R096	1-216-033-00	METAL GLAZE 220 5%	1/10W	R364	1-216-295-00	METAL GLAZE 0 5%	1/10W
R097	1-216-033-00	METAL GLAZE 220 5%	1/10W	R365	1-216-049-00	METAL GLAZE 1K 5%	1/10W
R101	1-216-073-00	METAL GLAZE 10K 5%	1/10W	R367	1-216-109-00	METAL GLAZE 330K 5%	1/10W
R102	1-216-039-00	METAL GLAZE 390 5%	1/10W	R401	1-216-022-00	METAL GLAZE 75 5%	1/10W
R203	1-215-924-00	METAL OXIDE 15K 5%	3W F	R402	1-216-022-00	METAL GLAZE 75 5%	1/10W
R206	1-216-689-11	METAL GLAZE 39K 5%	1/10W	R403	1-216-022-00	METAL GLAZE 75 5%	1/10W
R207	1-216-083-00	METAL GLAZE 27K 5%	1/10W	R404	1-216-295-00	METAL GLAZE 0 5%	1/10W
R251	1-216-059-00	METAL GLAZE 2.7K 5%	1/10W	R405	1-216-113-00	METAL GLAZE 470K 5%	1/10W
R252	1-216-059-00	METAL GLAZE 2.7K 5%	1/10W	R406	1-216-113-00	METAL GLAZE 470K 5%	1/10W
R253	1-216-061-00	METAL GLAZE 3.3K 5%	1/10W	R409	1-216-295-00	METAL GLAZE 0 5%	1/10W
R254	1-216-015-00	METAL GLAZE 39 5%	1/10W	R410	1-216-022-00	METAL GLAZE 75 5%	1/10W
R256	1-216-015-00	METAL GLAZE 39 5%	1/10W	R411	1-216-113-00	METAL GLAZE 470K 5%	1/10W
R257	1-216-061-00	METAL GLAZE 3.3K 5%	1/10W	R412	1-216-113-00	METAL GLAZE 470K 5%	1/10W
R258	1-216-051-00	METAL GLAZE 1.2K 5%	1/10W	R413	1-216-295-00	METAL GLAZE 0 5%	1/10W
R259	1-216-051-00	METAL GLAZE 1.2K 5%	1/10W	R414	1-216-041-00	METAL GLAZE 470 5%	1/10W
R262	1-216-075-00	METAL GLAZE 12K 5%	1/10W	R415	1-216-041-00	METAL GLAZE 470 5%	1/10W
R263	1-216-075-00	METAL GLAZE 12K 5%	1/10W	R419	1-249-409-11	CARBON 220 5%	1/4W
R264	1-216-041-00	METAL GLAZE 470 5%	1/10W	R423	1-216-295-00	METAL GLAZE 0 5%	1/10W
R265	1-216-085-00	METAL GLAZE 33K 5%	1/10W	R424	1-216-025-00	METAL GLAZE 100 5%	1/10W
R266	1-216-085-00	METAL GLAZE 33K 5%	1/10W	R429	1-216-295-00	METAL GLAZE 0 5%	1/10W
R267	1-216-089-00	METAL GLAZE 47K 5%	1/10W	R430	1-216-295-00	METAL GLAZE 0 5%	1/10W
R268	1-216-065-00	METAL GLAZE 4.7K 5%	1/10W	R441	1-216-073-00	METAL GLAZE 10K 5%	1/10W
R269	1-249-385-11	CARBON 2.2 5%	1/4W	R442	1-216-049-00	METAL GLAZE 1K 5%	1/10W
R270	1-249-385-11	CARBON 2.2 5%	1/4W	R443	1-216-073-00	METAL GLAZE 10K 5%	1/10W
R271	1-249-417-11	CARBON 1K 5%	1/4W	R444	1-216-049-00	METAL GLAZE 1K 5%	1/10W
R272	1-249-411-11	CARBON 330 5%	1/4W	R445	1-216-049-00	METAL GLAZE 1K 5%	1/10W
R273	1-249-411-11	CARBON 330 5%	1/4W	R447	1-216-049-00	METAL GLAZE 1K 5%	1/10W
R276	1-249-417-11	CARBON 1K 5%	1/4W	R448	1-249-417-11	CARBON 1K 5%	1/4W
R301	1-216-065-00	METAL GLAZE 4.7K 5%	1/10W	R449	1-216-049-00	METAL GLAZE 1K 5%	1/10W
R302	1-216-057-00	METAL GLAZE 2.2K 5%	1/10W	R450	1-216-025-00	METAL GLAZE 100 5%	1/10W
R311	1-216-678-11	METAL CHIP 13K 0.50%	1/10W	R452	1-249-417-11	CARBON 1K 5%	1/4W
R312	1-216-079-00	METAL GLAZE 18K 5%	1/10W	R453	1-216-049-00	METAL GLAZE 1K 5%	1/10W
R313	1-216-653-11	METAL CHIP 1.2K 0.50%	1/10W	R454	1-216-049-00	METAL GLAZE 1K 5%	1/10W
R314	1-216-117-00	METAL GLAZE 680K 5%	1/10W	R455	1-216-295-00	METAL GLAZE 0 5%	1/10W
R315	1-216-051-00	METAL GLAZE 1.2K 5%	1/10W	R456	1-216-295-00	METAL GLAZE 0 5%	1/10W
R319	1-216-295-00	METAL GLAZE 0 5%	1/10W	R457	1-216-295-00	METAL GLAZE 0 5%	1/10W
R320	1-216-295-00	METAL GLAZE 0 5%	1/10W	R458	1-216-073-00	METAL GLAZE 10K 5%	1/10W
R321	1-216-295-00	METAL GLAZE 0 5%	1/10W	R459	1-216-295-00	METAL GLAZE 0 5%	1/10W
R322	1-216-295-00	METAL GLAZE 0 5%	1/10W	R460	1-216-295-00	METAL GLAZE 0 5%	1/10W
R323	1-216-121-00	METAL GLAZE 1M 5%	1/10W	R469	1-216-073-00	METAL GLAZE 10K 5%	1/10W
R324	1-216-025-00	METAL GLAZE 100 5%	1/10W	R471	1-216-295-00	METAL GLAZE 0 5%	1/10W
R326	1-216-025-00	METAL GLAZE 100 5%	1/10W	R472	1-216-041-00	METAL GLAZE 470 5%	1/10W
R327	1-216-077-00	METAL GLAZE 15K 5%	1/10W	R473	1-216-043-00	METAL GLAZE 560 5%	1/10W
R328	1-216-025-00	METAL GLAZE 100 5%	1/10W	R476	1-249-429-11	CARBON 10K 5%	1/4W
R329	1-216-073-00	METAL GLAZE 10K 5%	1/10W	R477	1-216-073-00	METAL GLAZE 10K 5%	1/10W
R330	1-216-067-00	METAL GLAZE 5.6K 5%	1/10W	R479	1-216-295-00	METAL GLAZE 0	1/10W
R331	1-216-093-00	METAL GLAZE 68K 5%	1/10W				

The components identified by **■** in this manual have been carefully factory-selected for each set in order to satisfy regulations regarding X-ray radiation.

Should replacement be required, replace only with the value originally used.

The components identified by shading and mark **▲** are critical for safety.
Replace only with part number specified.

Les composants identifiés par une trame et une marque **▲** sont critiques pour la sécurité.
Ne les remplacer que par une pièce portant le numéro spécifié.

A (KV-20TS32)

G (KV-20TS29/20TS32/2170RS)

REF. NO.	PART NO.	DESCRIPTION	REMARK
R480	1-216-295-00	METAL GLAZE	0 5% 1/10W
R501	1-249-429-11	CARBON	10K 5% 1/4W
R502	1-216-073-00	METAL GLAZE	10K 5% 1/10W
R505	1-216-349-00	METAL OXIDE	1 5% 1W F
R506	1-216-429-00	METAL OXIDE	270 5% 1W F
R507	1-247-887-00	CARBON	220K 5% 1/4W
R508	1-216-049-00	METAL GLAZE	1K 5% 1/10W
R509	1-216-101-00	METAL GLAZE	150K 5% 1/10W
R510	1-216-055-00	METAL GLAZE	1.8K 5% 1/10W
■R511 ▲		METAL	1/10W
R512	1-215-445-00	METAL	10K 1% 1/10W
R513	1-216-645-11	METAL CHIP	560 0.50% 1/10W
R515	1-216-673-11	METAL CHIP	8.2K 0.50% 1/10W
R517	1-216-699-11	METAL CHIP	100K 0.50% 1/10W
R518	1-215-431-00	METAL	2.7K 1% 1/4W
R519	1-215-427-00	METAL	1.8K 1% 1/4W
R520	1-216-073-00	METAL GLAZE	10K 5% 1/10W
R530	1-249-419-11	CARBON	1.5K 5% 1/4W
R531	1-216-357-00	METAL OXIDE	4.7 5% 1W F
R532 ▲	1-215-880-91	METAL OXIDE	10 5% 2W F
R533	1-216-359-00	METAL OXIDE	6.8 5% 1W F
R534	1-249-393-11	CARBON	10 5% 1/4W F
R535	1-249-389-11	CARBON	4.7 5% 1/4W F
■R537 ▲		METAL	1/10W
R538	1-249-441-11	CARBON	100K 5% 1/4W
R541	1-249-418-11	CARBON	1.2K 5% 1/4W F
R542	1-216-357-00	METAL OXIDE	4.7 5% 1W F
R549	1-216-369-00	METAL OXIDE	1 5% 2W F
R554	1-216-061-00	METAL GLAZE	3.3K 5% 1/10W
R555	1-215-896-00	METAL OXIDE	4.7K 5% 2W F
R558	1-249-415-11	CARBON	680 5% 1/4W F
R559	1-215-862-11	METAL OXIDE	68 5% 1W F
R565	1-249-377-11	CARBON	0.47 5% 1/4W F
R566	1-249-417-11	CARBON	1K 5% 1/4W F
R588	1-216-105-00	METAL GLAZE	220K 5% 1/10W
R590	1-216-063-00	METAL GLAZE	3.9K 5% 1/10W
R591	1-216-061-00	METAL GLAZE	3.3K 5% 1/10W
R592	1-216-073-00	METAL GLAZE	10K 5% 1/10W
R593	1-216-049-00	METAL GLAZE	1K 5% 1/10W
R594	1-216-689-11	METAL GLAZE	39K 5% 1/10W
R595	1-216-073-00	METAL GLAZE	10K 5% 1/10W
R599	1-215-857-11	METAL OXIDE	10 5% 1W F
R681	1-215-883-11	METAL OXIDE	33 5% 2W F
R682	1-249-415-11	CARBON	680 5% 1/4W
R683	1-216-356-00	METAL OXIDE	3.9 5% 1W F
R684	1-216-380-11	METAL OXIDE	8.2 5% 2W F
<SWITCH>			
S001	1-571-532-21	SWITCH, TACTIL	
S002	1-571-532-21	SWITCH, TACTIL	
S003	1-571-532-21	SWITCH, TACTIL	
S004	1-571-532-21	SWITCH, TACTIL	
S005	1-571-532-21	SWITCH, TACTIL	
S006	1-571-532-21	SWITCH, TACTIL	
<SPARK GAP>			
SG551	1-519-422-11	GAP, SPARK	
<TRANSFORMER>			
T504 ▲	1-453-141-11	TRANSFORMER ASSY, FLYBACK (NX-1600A5)	

REF. NO.	PART NO.	DESCRIPTION	REMARK
T551	1-437-195-11	TRANSFORMER, HORIZONTAL DRIVE	
<TUNER>			
TU101A	8-598-039-01	TUNER BTF-WA401	
<CRYSTAL>			
X001	1-579-917-21	VIBRATOR, CRYSTAL	
X301	1-567-505-11	OSCILLATOR, CRYSTAL	

*A-1316-146-A		G BOARD, COMPLETE	

(KV-20TS29(U/C), 20TS32, 2170RS)			
1-533-223-11		CLIP, FUSE	
4-382-854-11		SCREW (M3X10), P, SW (+)	
<CAPACITOR>			
C601 ▲	1-136-311-51	FILM	0.47MF 20% 125V
C603	1-124-478-11	ELECT	100MF 20% 25V
C604 ▲	1-162-677-51	CERAMIC	470PF 10% 125V
C605 ▲	1-162-677-51	CERAMIC	470PF 10% 125V
C606 ▲	1-102-050-51	CERAMIC	0.01MF 500V
C607 ▲	1-102-050-51	CERAMIC	0.01MF 500V
C613	1-104-759-11	ELECT	470MF 20% 200V
C614	1-104-759-11	ELECT	470MF 20% 200V
C615	1-164-625-11	CERAMIC	680PF 10% 500V
C616	1-136-169-00	FILM	0.22MF 5% 50V
C617	1-136-169-00	FILM	0.22MF 5% 50V
C618	1-164-625-11	CERAMIC	680PF 10% 500V
C619	1-164-625-11	CERAMIC	680PF 10% 500V
C620	1-136-601-11	FILM	0.01MF 10% 630V
C621	1-129-744-91	FILM	0.027MF 10% 400V
C622	1-124-478-11	ELECT	100MF 20% 25V
C623	1-124-360-00	ELECT	1000MF 20% 16V
C624	1-124-557-11	ELECT	1000MF 20% 25V
C626	1-123-024-21	ELECT	33MF 160V
C627	1-136-601-11	FILM	0.01MF 10% 630V
C629	1-106-355-12	MYLAR	0.0033MF 10% 200V
C630	1-136-169-00	FILM	0.22MF 5% 50V
C631	1-136-169-00	FILM	0.22MF 5% 50V
C632	1-136-169-00	FILM	0.22MF 5% 50V
C633 ▲	1-162-677-51	CERAMIC	470PF 10% 125V
C634 ▲	1-162-677-51	CERAMIC	470PF 10% 125V
C635	1-137-372-11	FILM	0.022MF 5% 50V
C636	1-162-318-11	CERAMIC	0.001MF 10% 500V
C637	1-164-735-11	CERAMIC	1500PF 10% 500V
C638	1-164-735-11	CERAMIC	1500PF 10% 500V
C639	1-164-735-11	CERAMIC	1500PF 10% 500V
C640	1-164-735-11	CERAMIC	1500PF 10% 500V
<CONNECTOR>			
CN601	*1-580-843-11	PIN, CONNECTOR (POWER)	
CN602	*1-508-786-00	PIN, CONNECTOR (5MM PITCH) 2P	
CN603	*1-508-765-00	PIN, CONNECTOR (5MM PITCH) 3P	
CN604	*1-564-510-11	PLUG, CONNECTOR 7P	
CN605	*1-691-135-11	PIN, CONNECTOR (PC BOARD) 4P	
CN606	*1-564-505-11	PLUG, CONNECTOR 2P	

Les composants identifiés par une trame et une marque **Δ** sont critiques pour la sécurité. Ne les remplacer que par une pièce portant le numéro spécifique.

The components identified by shading and mark **Δ** are critical for safety. Replace only with part number specified.

G (KV-20TS29/20TS32/2170RS)

G (KV-21STR2)

REF.NO.	PART NO.	DESCRIPTION	REMARK
<DIODE>			
D604	8-719-911-19	DIODE 1SS119	
D606 Δ	8-719-510-53	DIODE D4SB60L	
D607	8-719-510-48	DIODE D1N20R	
D608	8-719-510-48	DIODE D1N20R	
D609	8-719-510-48	DIODE D1N20R	
D610	8-719-510-48	DIODE D1N20R	
D611	8-719-032-13	DIODE D1NS6-TA2	
D612	8-719-510-02	DIODE D1NS4	
D613	8-719-510-02	DIODE D1NS4	
D614	8-719-510-02	DIODE D1NS4	
D615	8-719-510-02	DIODE D1NS4	
D616	8-719-510-26	DIODE D1NL20	
D617	8-719-510-26	DIODE D1NL20	
D618	8-719-510-26	DIODE D1NL20	
D619	8-719-510-26	DIODE D1NL20	
D620	8-719-510-02	DIODE D1NS4	
D621	8-719-510-02	DIODE D1NS4	
D622	8-719-510-48	DIODE D1N20R	
D624	8-719-911-19	DIODE 1SS119	
D625	8-719-911-19	DIODE 1SS119	
D626	8-719-110-14	DIODE RD9.1ES-B3	
D627	8-719-911-19	DIODE 1SS119	
D629	8-719-911-19	DIODE 1SS119	
D631	8-719-510-48	DIODE D1N20R	
<FUSE>			
F601 Δ	1-532-748-11	FUSE, GLASS TUBE 6.3A/125V	
<FERRITE BEAD>			
FB601	1-412-911-11	INDUCTOR, FERRITE BEAD	
FB602	1-412-911-11	INDUCTOR, FERRITE BEAD	
FB603	1-412-911-11	INDUCTOR, FERRITE BEAD	
FB604	1-412-911-11	INDUCTOR, FERRITE BEAD	
FB605	1-410-396-41	FERRITE BEAD INDUCTOR	
FB606	1-410-396-41	FERRITE BEAD INDUCTOR	
FB607	1-410-396-41	FERRITE BEAD INDUCTOR	
FB608	1-410-396-41	FERRITE BEAD INDUCTOR	
FB609	1-410-396-41	FERRITE BEAD INDUCTOR	
<IC>			
IC602 Δ	1-810-050-11	POWER MODULE DM-47	
<COIL>			
L601	1-412-533-61	INDUCTOR 47UH	
<TRANSISTOR>			
Q602	8-729-119-78	TRANSISTOR 2SC2785-HFE	
Q603	8-729-016-15	TRANSISTOR 2SC4833MNP	
Q604	8-729-016-15	TRANSISTOR 2SC4833MNP	
Q605	8-729-924-90	TRANSISTOR 2SB1370-EF	
Q606	8-729-119-78	TRANSISTOR 2SC2785-HFE	
<RESISTOR>			
R602	1-249-421-11	CARBON 2.2K 5% 1/4W F	
R604	1-249-421-11	CARBON 2.2K 5% 1/4W	
R608	1-247-893-11	CARBON 390K 5% 1/4W	
R609	1-247-893-11	CARBON 390K 5% 1/4W	

REF.NO.	PART NO.	DESCRIPTION	REMARK
R610	1-202-933-11	FUSIBLE 0.1 10% 1/2W F	
R612	1-216-349-00	METAL OXIDE 1 5% 1W F	
R613	1-216-349-00	METAL OXIDE 1 5% 1W F	
R614	1-215-904-71	METAL OXIDE 100K 5% 2W F	
R615	1-215-904-71	METAL OXIDE 100K 5% 2W F	
R616	1-215-858-71	METAL OXIDE 15 5% 1W F	
R617	1-215-858-71	METAL OXIDE 15 5% 1W F	
R618	1-217-386-00	FUSIBLE 8.2 5% 1/4W F	
R619	1-212-853-61	FUSIBLE 6.8 5% 1/4W F	
R620	1-249-379-11	CARBON 0.68 5% 1/4W F	
R621	1-249-377-11	CARBON 0.47 5% 1/4W F	
R622	1-249-377-11	CARBON 0.47 5% 1/4W F	
R623	1-249-377-11	CARBON 0.47 5% 1/4W F	
R624	1-249-425-11	CARBON 4.7K 5% 1/4W F	
R626	1-247-883-00	CARBON 150K 5% 1/4W	
R627	1-249-377-11	CARBON 0.47 5% 1/4W F	
R630	1-249-377-11	CARBON 0.47 5% 1/4W F	
R631	1-249-377-11	CARBON 0.47 5% 1/4W F	
R632	1-249-377-11	CARBON 0.47 5% 1/4W F	
R633	1-249-388-11	CARBON 3.9 5% 1/4W F	
R635	1-249-433-11	CARBON 22K 5% 1/4W	
R636	1-249-421-11	CARBON 2.2K 5% 1/4W	
R637	1-249-407-11	CARBON 150 5% 1/4W F	
R639 Δ	1-202-892-91	SOLID 4.7M 20% 1/2W	
R640	1-249-414-11	CARBON 560 5% 1/4W	
R642	1-249-421-11	CARBON 2.2K 5% 1/4W	
R643	1-215-863-71	METAL OXIDE 100 5% 1W F	
R645	1-217-386-00	FUSIBLE 8.2 5% 1/4W F	
R646	1-216-422-71	METAL OXIDE 18 5% 1W F	
R647	1-216-425-11	METAL OXIDE 56 5% 1W F	
R648	1-249-421-11	CARBON 2.2K 5% 1/4W	
R649	1-249-417-11	CARBON 1K 5% 1/4W	
R650	1-249-417-11	CARBON 1K 5% 1/4W	
R651	1-249-421-11	CARBON 2.2K 5% 1/4W F	
R652	1-249-417-11	CARBON 1K 5% 1/4W	
R653	1-249-417-11	CARBON 1K 5% 1/4W	
<RELAY>			
RY601 Δ	1-515-684-31	RELAY	
RY602	1-515-684-31	RELAY	
<TRANSFORMER>			
T601 Δ	1-423-585-11	TRANSFORMER, LINE FILTER (LFT)	
T602 Δ	1-423-585-11	TRANSFORMER, LINE FILTER (LFT)	
T603 Δ	1-423-563-11	TRANSFORMER, CONVERTER DRIVE	
T604	1-423-582-11	TRANSFORMER, FERRITE (SBT)	
T605 Δ	1-423-564-11	TRANSFORMER, CONVERTER (PIT)	
<THERMISTOR>			
THP601 Δ	1-808-081-14	THERMISTOR, POSITIVE	
<VARISTOR>			
VDR601	1-810-052-21	VARISTOR	
VDR602	1-810-052-21	VARISTOR	

*A-1316-148-A	G BOARD, COMPLETE (KV-21STR2)	*****	
1-533-223-11	CLIP, FUSE	*****	

The components identified by shading and mark **Δ** are critical for safety. Replace only with part number specified.

Les composants identifiés par une trame et une marque **Δ** sont critiques pour la sécurité. Ne les remplacer que par une pièce portant le numéro spécifié.

G (KV-21STR2)

REF. NO.	PART NO.	DESCRIPTION	REMARK	REF. NO.	PART NO.	DESCRIPTION	REMARK
	4-382-854-11	SCREW (M3X10), P, SW (+)		D617	8-719-510-26	DIODE D1NL20	
		<CAPACITOR>		D618	8-719-510-26	DIODE D1NL20	
C601	Δ 1-136-311-61	FILM 0.47MF 20% 300V		D619	8-719-510-26	DIODE D1NL20	
C603	1-124-478-11	ELECT 100MF 20% 25V		D620	8-719-510-02	DIODE D1NS4	
C606	Δ 1-102-050-51	CERAMIC 0.01MF 500V		D621	8-719-510-02	DIODE D1NS4	
C607	Δ 1-102-050-51	CERAMIC 0.01MF 500V		D622	8-719-510-48	DIODE D1N20R	
C608	Δ 1-137-376-91	FILM 0.1MF 5% 50V		D624	8-719-911-19	DIODE 1SS119	
C609	1-106-383-00	MYLAR 0.047MF 200V		D625	8-719-911-19	DIODE 1SS119	
C610	Δ 1-126-406-91	ELECT 2.2MF 20% 400V		D626	8-719-110-14	DIODE RD9.1ES-B3	
C611	Δ 1-124-122-91	ELECT 100MF 20% 50V		D627	8-719-911-19	DIODE 1SS119	
C612	Δ 1-137-376-91	FILM 0.1MF 5% 50V		D629	8-719-911-19	DIODE 1SS119	
C613	1-104-758-11	ELECT 560MF 20% 250V		D631	8-719-510-48	DIODE D1N20R	
C614	1-104-758-11	ELECT 560MF 20% 250V				<FUSE>	
C615	1-164-625-11	CERAMIC 680PF 10% 500V		F601	Δ 1-532-506-51	FUSE 6.3A/250V	
C616	1-136-169-00	FILM 0.22MF 5% 50V				<FERRITE BEAD>	
C617	1-136-169-00	FILM 0.22MF 5% 50V		FB601	1-412-911-11	INDUCTOR, FERRITE BEAD	
C618	1-164-625-11	CERAMIC 680PF 10% 500V		FB602	1-412-911-11	INDUCTOR, FERRITE BEAD	
C619	1-164-625-11	CERAMIC 680PF 10% 500V		FB603	1-412-911-11	INDUCTOR, FERRITE BEAD	
C620	1-136-601-11	FILM 0.01MF 10% 630V		FB604	1-412-911-11	INDUCTOR, FERRITE BEAD	
C621	1-129-744-91	FILM 0.027MF 10% 400V		FB605	1-410-396-41	FERRITE BEAD INDUCTOR	
C622	1-124-478-11	ELECT 100MF 20% 25V		FB606	1-410-396-41	FERRITE BEAD INDUCTOR	
C623	1-124-360-00	ELECT 1000MF 20% 16V		FB607	1-410-396-41	FERRITE BEAD INDUCTOR	
C624	1-124-557-11	ELECT 1000MF 20% 25V		FB608	1-410-396-41	FERRITE BEAD INDUCTOR	
C626	1-123-024-21	ELECT 33MF 160V		FB609	1-410-396-41	FERRITE BEAD INDUCTOR	
C627	1-136-601-11	FILM 0.01MF 10% 630V				<IC>	
C629	1-106-355-12	MYLAR 0.0033MF 10% 200V		IC601	Δ 8-749-923-94	IC STR81159A	
C630	1-136-169-00	FILM 0.22MF 5% 50V		IC602	Δ 1-810-050-11	POWER MODULE DM-47	
C631	1-136-169-00	FILM 0.22MF 5% 50V				<COIL>	
C632	1-136-169-00	FILM 0.22MF 5% 50V		L601	1-412-533-61	INDUCTOR 47UH	
C633	Δ 1-164-502-51	CERAMIC 0.001MF 20% 400V				<TRANSISTOR>	
C634	Δ 1-164-502-51	CERAMIC 0.001MF 20% 400V		Q602	8-729-119-78	TRANSISTOR 2SC2785-HFE	
C635	1-137-372-11	FILM 0.022MF 5% 50V		Q603	8-729-016-15	TRANSISTOR 2SC4833MNP	
C636	1-162-318-11	CERAMIC 0.001MF 10% 500V		Q604	8-729-016-15	TRANSISTOR 2SC4833MNP	
C637	1-164-735-11	CAP, CERAMIC 1500PF		Q605	8-729-924-90	TRANSISTOR 2SB1370-EF	
C638	1-164-735-11	CAP, CERAMIC 1500PF		Q606	8-729-119-78	TRANSISTOR 2SC2785-HFE	
C639	1-164-735-11	CAP, CERAMIC 1500PF				<RESISTOR>	
C640	1-164-735-11	CAP, CERAMIC 1500PF		R602	1-249-421-11	CARBON 2.2K 5% 1/4W F	
		<CONNECTOR>		R604	1-249-421-11	CARBON 2.2K 5% 1/4W F	
CN601	*1-580-843-11	PIN, CONNECTOR (POWER)		R605	Δ 1-249-451-71	CARBON 2.2 5% 1/4W F	
CN602	*1-508-786-00	PIN, CONNECTOR (5MM PITCH) 2P		R606	Δ 1-208-294-11	WIREWOUND 2.2 5% 20W F	
CN603	*1-508-765-00	PIN, CONNECTOR (5MM PITCH) 3P		R607	1-249-389-11	CARBON 4.7 5% 1/4W	
CN604	*1-564-510-11	PLUG, CONNECTOR 7P		R608	1-247-893-11	CARBON 390K 5% 1/4W	
CN605	*1-691-135-11	PIN, CONNECTOR (PC BOARD) 4P		R609	1-247-893-11	CARBON 390K 5% 1/4W	
CN606	*1-564-505-11	PLUG, CONNECTOR 2P		R610	1-202-933-11	FUSIBLE 0.1 10% 1/2W F	
		<DIODE>		R612	1-216-349-00	METAL OXIDE 1 5% 1W F	
D604	8-719-911-19	DIODE 1SS119		R613	1-216-349-00	METAL OXIDE 1 5% 1W F	
D605	Δ 8-719-304-63	DIODE RM11C		R614	1-215-904-71	METAL OXIDE 100K 5% 2W F	
D606	Δ 8-719-510-53	DIODE D4SB60L		R615	1-215-904-71	METAL OXIDE 100K 5% 2W F	
D607	8-719-510-48	DIODE D1N20R		R616	1-215-858-71	METAL OXIDE 15 5% 1W F	
D608	8-719-510-48	DIODE D1N20R		R617	1-215-858-71	METAL OXIDE 15 5% 1W F	
D609	8-719-510-48	DIODE D1N20R		R618	1-217-386-00	FUSIBLE 8.2 5% 1/4W F	
D610	8-719-510-48	DIODE D1N20R		R619	1-212-853-61	FUSIBLE 6.8 5% 1/4W F	
D611	8-719-032-13	DIODE D1NS6-TA2					
D612	8-719-510-02	DIODE D1NS4					
D613	8-719-510-02	DIODE D1NS4					
D614	8-719-510-02	DIODE D1NS4					
D615	8-719-510-02	DIODE D1NS4					
D616	8-719-510-26	DIODE D1NL20					

G (KV-21STR2)

C

Les composants identifiés par une trame et une marque **Δ** sont critiques pour la sécurité. Ne les remplacer que par une pièce portant le numéro spécifié.

The components identified by shading and mark **Δ** are critical for safety. Replace only with part number specified.

REF.NO.	PART NO.	DESCRIPTION	REMARK	REF.NO.	PART NO.	DESCRIPTION	REMARK
R620	1-249-379-11	CARBON	0.68 5% 1/4W F	C751	1-164-083-11	CERAMIC 680PF	10% 50V
R621	1-249-377-11	CARBON	0.47 5% 1/4W F	C752	1-164-082-11	CERAMIC 560PF	10% 50V
R622	1-249-377-11	CARBON	0.47 5% 1/4W F	C771	1-164-083-11	CERAMIC 680PF	10% 50V
R623	1-249-377-11	CARBON	0.47 5% 1/4W F	C772	1-164-083-11	CERAMIC 680PF	10% 50V
R624	1-249-425-11	CARBON	4.7K 5% 1/4W F	C773	1-164-083-11	CERAMIC 680PF	10% 50V
R626	1-247-883-00	CARBON	150K 5% 1/4W	<CONNECTOR>			
R627	1-249-377-11	CARBON	0.47 5% 1/4W F	CN701	1-695-915-11	TAB (CONTACT)	
R630	1-249-377-11	CARBON	0.47 5% 1/4W F	CN702	*1-508-768-00	PIN, CONNECTOR (5MM PITCH) 6P	
R631	1-249-377-11	CARBON	0.47 5% 1/4W F	CN703	*1-564-509-11	PLUG, CONNECTOR 6P	
R632	1-249-377-11	CARBON	0.47 5% 1/4W F	<DIODE>			
R633	1-249-388-11	CARBON	3.9 5% 1/4W F	D711	8-719-911-19	DIODE 1SS119	
R635	1-249-433-11	CARBON	22K 5% 1/4W	D731	8-719-911-19	DIODE 1SS119	
R636	1-249-421-11	CARBON	2.2K 5% 1/4W	D751	8-719-911-19	DIODE 1SS119	
R637	1-249-407-11	CARBON	150 5% 1/4W F	D770	8-719-911-19	DIODE 1SS119	
R639 Δ	1-247-289-11	CARBON	8.2M 5% 1W	D771	8-719-911-19	DIODE 1SS119	
R640	1-249-414-11	CARBON	560 5% 1/4W	D772	8-719-911-19	DIODE 1SS119	
R642	1-249-421-11	CARBON	2.2K 5% 1/4W	D773	8-719-911-19	DIODE 1SS119	
R643	1-215-863-71	METAL OXIDE	100 5% 1W F	D777	8-719-109-71	DIODE RD3.9ES-B1	
R644 Δ	1-215-915-71	METAL OXIDE	470 5% 3W F	D790	8-719-911-19	DIODE 1SS119	
R645	1-217-386-00	FUSIBLE	8.2 5% 1/4W F	D791	8-719-911-19	DIODE 1SS119	
R646	1-216-422-71	METAL OXIDE	18 5% 1W F	D792	8-719-911-19	DIODE 1SS119	
R647	1-216-425-11	METAL OXIDE	56 5% 1W F	<JACK>			
R648	1-249-421-11	CARBON	2.2K 5% 1/4W	J701 Δ	1-540-071-13	SOCKET, PICTURE TUBE	
R649	1-249-417-11	CARBON	1K 5% 1/4W	<COIL>			
R650	1-249-417-11	CARBON	1K 5% 1/4W	L701	1-410-671-31	INDUCTOR 47UH	
R651	1-249-421-11	CARBON	2.2K 5% 1/4W F	<TRANSISTOR>			
R652	1-249-417-11	CARBON	1K 5% 1/4W	Q711	8-729-926-73	TRANSISTOR 2SC3271F-N	
R653	1-249-417-11	CARBON	1K 5% 1/4W	Q712	8-729-119-78	TRANSISTOR 2SC2785-HFE	
<RELAY>				Q731	8-729-926-73	TRANSISTOR 2SC3271F-N	
RY601 Δ	1-515-684-31	RELAY		Q732	8-729-119-78	TRANSISTOR 2SC2785-HFE	
RY602	1-515-684-31	RELAY		Q751	8-729-926-73	TRANSISTOR 2SC3271F-N	
<TRANSFORMER>				Q752	8-729-119-78	TRANSISTOR 2SC2785-HFE	
T602 Δ	1-423-585-11	TRANSFORMER, LINE FILTER (LFT)		Q770	8-729-119-76	TRANSISTOR 2SA1175-HFE	
T603 Δ	1-423-563-11	TRANSFORMER, CONVERTER DRIVE		Q771	8-729-200-17	TRANSISTOR 2SA1091-0	
T604	1-423-582-21	TRANSFORMER, FERRITE (SBT)		Q772	8-729-200-17	TRANSISTOR 2SA1091-0	
T605 Δ	1-423-564-11	TRANSFORMER, CONVERTER (PIT)		Q773	8-729-200-17	TRANSISTOR 2SA1091-0	
<THERMISTOR>				<RESISTOR>			
THP601 Δ	1-808-059-32	THERMISTOR, POSITIVE		R700	1-202-549-00	SOLID 100 20% 1/2W	
<VARISTOR>				R701	1-202-846-00	SOLID 470K 20% 1/2W	
VDR601	1-810-052-21	VARISTOR		R702	1-202-844-00	SOLID 330K 20% 1/2W	
VDR602	1-810-052-21	VARISTOR		R703	1-202-838-00	SOLID 100K 20% 1/2W	
*****				R704	1-216-370-11	METAL OXIDE 1.2 5% 2W F	
*A-1331-246-A	C BOARD, COMPLETE			R706	1-202-842-11	SOLID 220K 20% 1/2W	
*****				R710	1-202-824-00	SOLID 3.3K 20% 1/2W	
<CAPACITOR>				R711	1-249-405-11	CARBON 100 5% 1/4W	
C701	1-136-601-11	FILM 0.01MF	10% 630V	R712	1-215-924-00	METAL OXIDE 15K 5% 3W F	
C704	1-162-116-00	CERAMIC 680PF	10% 2KV	R716	1-249-411-11	CARBON 330 5% 1/4W	
C706	1-124-916-11	ELECT 22MF	20% 25V	R717	1-249-393-11	CARBON 10 5% 1/4W	
C707	1-164-085-11	CERAMIC 0.001MF	10% 50V	R730	1-202-824-00	SOLID 3.3K 20% 1/2W	
C711	1-164-083-11	CERAMIC 680PF	10% 50V	R731	1-249-405-11	CARBON 100 5% 1/4W	
C712	1-164-082-11	CERAMIC 560PF	10% 50V	R732	1-215-924-00	METAL OXIDE 15K 5% 3W F	
C731	1-164-083-11	CERAMIC 680PF	10% 50V	R736	1-249-411-11	CARBON 330 5% 1/4W	
C732	1-164-081-11	CERAMIC 470PF	10% 50V	www.DataSheet4U.com			

The components identified by shading and mark **Δ** are critical for safety. Replace only with part number specified.

Les composants identifiés par une trame et une marque **Δ** sont critiques pour la sécurité. Ne les remplacer que par une pièce portant le numéro spécifié.

C **S** (KV-20TS29(U)/20TS32)

REF. NO.	PART NO.	DESCRIPTION	REMARK
R737	1-249-393-11	CARBON 10 5% 1/4W	
R750	1-202-824-00	SOLID 3.3K 20% 1/2W	
R751	1-249-405-11	CARBON 100 5% 1/4W	
R752	1-215-924-00	METAL OXIDE 15K 5% 3W	F
R756	1-249-411-11	CARBON 330 5% 1/4W	
R757	1-249-393-11	CARBON 10 5% 1/4W	
R770	1-249-433-11	CARBON 22K 5% 1/4W	
R771	1-249-409-11	CARBON 220 5% 1/4W	F
R772	1-249-409-11	CARBON 220 5% 1/4W	F
R773	1-249-409-11	CARBON 220 5% 1/4W	F
R774	1-249-437-11	CARBON 47K 5% 1/4W	
R775	1-249-417-11	CARBON 1K 5% 1/4W	
R776	1-249-409-11	CARBON 220 5% 1/4W	
R790	1-249-417-11	CARBON 1K 5% 1/4W	
R791	1-249-413-11	CARBON 470 5% 1/4W	
<VARIABLE RESISTOR>			
RV701	Δ 1-241-656-21	RES. ADJ. METAL FILM 110M	
RV702	1-230-641-11	RES. ADJ. METAL GLAZE 2.2M	

*1-646-641-11	S BOARD (KV-20TS29(U), 20TS32)		*****
<CAPACITOR>			
C805	1-124-903-11	ELECT 1MF 20% 50V	
C806	1-137-399-11	FILM 0.1MF 5% 50V	
C807	1-102-157-00	CERAMIC 560PF 10% 500V	
C809	1-137-367-11	FILM 0.0033MF 5% 50V	
C810	1-137-399-11	FILM 0.1MF 5% 50V	
C811	1-137-399-11	FILM 0.1MF 5% 50V	
C812	1-137-375-11	FILM 0.068MF 5% 50V	
C813	1-124-907-11	ELECT 10MF 20% 50V	
C814	1-124-907-11	ELECT 10MF 20% 50V	
C815	1-124-907-11	ELECT 10MF 20% 50V	
C816	1-124-907-11	ELECT 10MF 20% 50V	
C817	1-124-907-11	ELECT 10MF 20% 50V	
C819	1-164-070-11	CERAMIC 100PF 5% 50V	
<CONNECTOR>			
CN801	*1-573-979-11	CONNECTOR, BOARD TO BOARD 11P	
<DIODE>			
D800	8-719-911-19	DIODE 1SS119	
<IC>			
IC801	8-759-084-09	IC Z8612812PSC	
<COIL>			
L801	1-410-470-11	INDUCTOR 10UH	
<TRANSISTOR>			
Q801	8-729-119-78	TRANSISTOR 2SC2785-HFE	
Q802	8-729-119-78	TRANSISTOR 2SC2785-HFE	
<RESISTOR>			

REF. NO.	PART NO.	DESCRIPTION	REMARK
R801	1-249-416-11	CARBON 820 5% 1/4W	
R802	1-249-416-11	CARBON 820 5% 1/4W	
R803	1-249-416-11	CARBON 820 5% 1/4W	
R804	1-249-425-11	CARBON 4.7K 5% 1/4W	
R805	1-249-425-11	CARBON 4.7K 5% 1/4W	
R806	1-249-423-11	CARBON 3.3K 5% 1/4W	
R807	1-249-425-11	CARBON 4.7K 5% 1/4W	
R808	1-249-417-11	CARBON 1K 5% 1/4W	
R809	1-249-441-11	CARBON 100K 5% 1/4W	
R810	1-249-437-11	CARBON 47K 5% 1/4W	
R812	1-249-417-11	CARBON 1K 5% 1/4W	
R813	1-249-417-11	CARBON 1K 5% 1/4W	
R814	1-249-413-11	CARBON 470 5% 1/4W	
R815	1-249-427-11	CARBON 6.8K 5% 1/4W	
R816	1-249-429-11	CARBON 10K 5% 1/4W	
R817	1-249-433-11	CARBON 22K 5% 1/4W	
R818	1-249-417-11	CARBON 1K 5% 1/4W	
R820	1-249-433-11	CARBON 22K 5% 1/4W	
R821	1-249-433-11	CARBON 22K 5% 1/4W	
R822	1-249-429-11	CARBON 10K 5% 1/4W	

MISCELLANEOUS			

Δ 1-426-358-11	COIL, DEMAGNETIZATION (KV-20TS29(U/C), 20TS32, 2170RS)		
Δ 1-426-368-11	COIL, DEMAGNETIZATION (KV-21STR2)		
Δ 1-451-280-11	DEFLECTION YOKE (Y21PXA2)		
1-452-032-00	MAGNET, DISK; 10MM φ		
1-452-094-00	MAGNET, ROTATABLE DISK; 15MM φ		
1-452-277-00	MAGNET, BMC		
1-573-657-11	PLUG, F-PIN		
Δ 1-751-057-11	CORD, POWER (WITH CONNECTOR) (KV-20TS29(U/C), 20TS32, 2170RS)		
Δ 1-751-056-11	CORD, POWER (WITH CONNECTOR) (KV-21STR2)		
SP901	1-504-252-11	SPEAKER (9X5CM)	
SP902	1-504-252-11	SPEAKER (9X5CM)	
Y901	Δ 8-738-764-05	PICTURE TUBE (A51JUH51X)	

ACCESSORIES AND PACKING MATERIALS			

1-417-182-11	CONVERTER (EAC-25)		
1-501-372-41	ANTENNA, TELESCOPIC		
1-569-007-11	ADAPTER, CONVERSION 2P (KV-21STR2)		
3-756-515-21	MANUAL, INSTRUCTION (ENGLISH)		
3-756-515-31	MANUAL, INSTRUCTION (FRENCH)		
3-756-515-41	MANUAL, INSTRUCTION (SPANISH) (KV-20TS29(C))		
3-756-515-41	MANUAL, INSTRUCTION (SPANISH) (KV-20TS32, 21STR2, 2170RS)		
*4-039-627-01	INDIVIDUAL CARTON		
*4-039-628-01	CUSHION (UPPER) (ASSY)		
*4-039-629-01	CUSHION (LOWER) (ASSY)		
*4-380-340-01	BAG, PROTECTION		
REMOTE COMMANDER			
1-466-966-11	REMOTE COMMANDER (RM-Y116)		
9-903-826-01	COVER, BATTERY (FOR RM-Y116)		

