

Micropower, 4.75V/500mA Low Noise CMOS LDO Regulator

Features

- Linear LDO regulator with 4.75V output
- 500mA output current capability
 - 500mA peak in SOT-23 package
- 500mV maximum dropout voltage at full load
- 150mV maximum dropout at 150mA load
- Excellent line and load regulation
- Stable with low ESR output capacitor
- Ultra low noise with optional bypass capacitor
- Fast power-up with bypass capacitor
- "Zero" current in Shutdown mode
- Thermal Overload Protection
- Foldback Current Limiting Protection
- Reverse current protection
- Lead-free version available

Applications

- Notebook computers
- Consumer and personal electronics
- Ideal for powering audio codecs

Product Description

The CM3016-48 is a CMOS linear voltage regulator with low quiescent current, very low drop out voltage and better than 1% initial output voltage accuracy. The quiescent current is typically 150 μ A at light loads and only 165 μ A at 500mA. This is 5% more efficient than equivalent Bi-CMOS devices that can waste up to 25mA at 500mA load. The CM3016-48 can maintain load regulation for peak currents up to 500mA, which is useful for supplying inrush currents during power-up and transient conditions. Continuous output current is limited by package type and board layout.

A dedicated control input (EN, Active High) has been included for power-up sequencing flexibility. When this input is taken low, the regulator is disabled. In this state, the supply current will drop to near zero. The device also features reverse current protection. This protects the device by blocking the pass transistors parasitic diode when the output voltage is forced higher than the input.

For low noise performance and increased power supply ripple rejection a noise bypass capacitor can be connected to the BYP pin. Connecting this capacitor will not significantly delay the speed of power-up.

The CM3016-48 is fully protected, offering both overload current limiting and high temperature thermal shutdown. To reduce board cost and layout size, the CM3016 was designed to be stable with or without an output capacitor. This includes tiny, low ESR ceramic capacitors.

The CM3016-48 is housed in a 5-pin SOT23 package and is ideal for space critical applications. It is available with optional lead-free finishing.

Typical Application Circuit

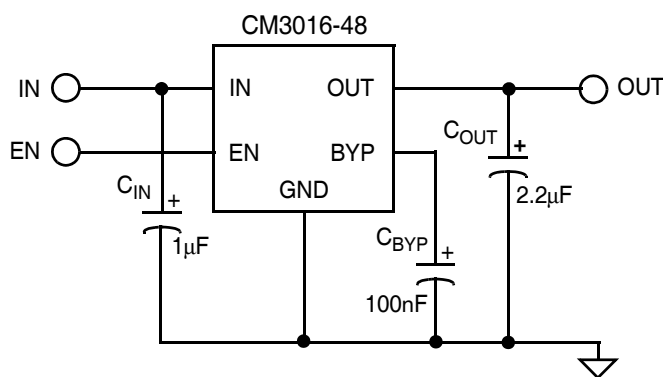

Simplified Electrical Schematic

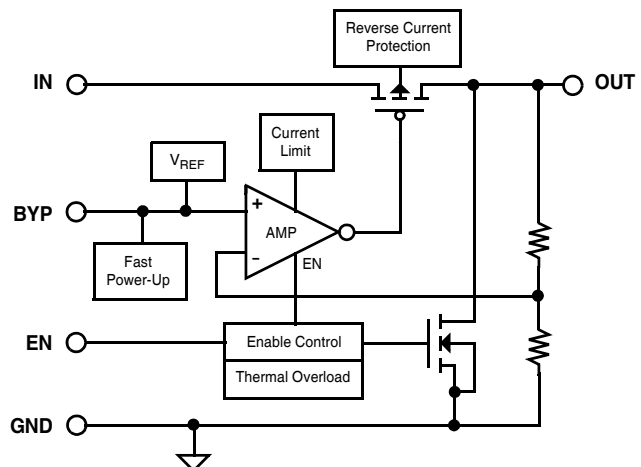

PACKAGE / PINOUT DIAGRAM

Top View

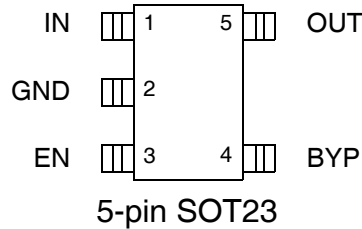

Note: This drawing is not to scale.

PIN DESCRIPTIONS

SOT23-5	NAME	DESCRIPTION
PIN(S)		
1	IN	Regulator input. If this input is within a few inches of the main supply filter, a capacitor may not be necessary. Otherwise an input filter capacitor of 1-10 μ F will ensure adequate filtering.
2	GND	Ground is the negative reference for all voltages
3	EN	Enable input. When this input is taken low (< 0.4V), the regulator is disabled. In this state, the supply current will drop to near zero.
4	BYP	Reference bypass input. Connect to an external capacitor for noise reduction. A 10nF-100nF ceramic capacitor is recommended.
5	OUT	Regulator output. No output capacitor is required for stability. Any type of output capacitor can be added to improve transient response, noise performance and power supply ripple rejection for frequencies over ~100kHz.

Ordering Information
PART NUMBERING INFORMATION

Pins	Package	Standard Finish		Lead-free Finish	
		Ordering Part Number ¹	Part Marking	Ordering Part Number ¹	Part Marking
5	SOT23	CM3016-48ST	CA48	CM3016-48SO	CR48

Note 1: Parts are shipped in Tape & Reel form unless otherwise specified.

Specifications

ABSOLUTE MAXIMUM RATINGS		
PARAMETER	RATING	UNITS
Pin Voltages		
IN	[GND - 0.6] to [+6.0]	V
EN	[GND - 0.6] to [$V_{IN} + 0.6$]	V
OUT	[GND - 0.6] to [$V_{IN} + 0.6$]	V
Storage Temperature Range	-40 to +150	°C
Operating Temperature Range		
Ambient	-40 to +85	°C
Junction	0 to +150	°C
Power Dissipation (Notes 1,2)	Internally Limited	W

Note 1: The CM3016-48 contains a thermal overload circuit that automatically disables the device thereby preventing excessive junction temperature. When the SOT23-5 package housing the device is mounted on a typical multi-layer board with moderate heat spreading copper area (2 square inches) will allow up to 0.315W to be safely dissipated. Please consult with factory for thermal evaluation assistance.

Note 2: Consult CAMD Technical Support for power dissipation information regarding the CM3016-48 packaged in the SOT23 package.

STANDARD OPERATING CONDITIONS		
PARAMETER	RATING	UNITS
V_{IN}	[$V_{OUT} + 0.15$] to 6.0	VDC
Ambient Operating Temperature Range	-40 to +85	°C
Load Current	0 to 500	mA
C_{OUT}	0 -100	μF

Specifications (continued)

ELECTRICAL OPERATING CHARACTERISTICS (SEE NOTE1)						
SYMBOL	PARAMETER	CONDITIONS	MIN	TYP	MAX	UNITS
V _{OUT}	Output Voltage	T _A = 25°C	4.70	4.75	4.80	V
		0°C < T _J < 125°C	4.66	4.75	4.85	V
		-40°C < T _J < 125°C	4.61	4.75	4.89	V
V _{R LINE}	Line Regulation (see Note 4)	V _{OUT} +1V < V _{IN} and 2.5V < V _{IN} < 6V		0.1	0.2 0.4	% %
V _{R LOAD}	Load Regulation	I _{OUT} =1mA to 500mA; V _{IN} =V _{OUT} +1V; Note 3		0.1	0.5 0.8	% %
R _{DROP}	Dropout Resistance	I _{OUT} =1mA to 500mA; V _{IN} =V _{OUT} (nominal)-100mV		0.7	1 1.2	Ω Ω
I _{GND}	Ground Current	with EN tied to V _{IN} ; I _{LOAD} = 1mA:		150	200	μA
		with EN tied to V _{IN} ; I _{LOAD} = 150mA:		165	200	μA
		with EN tied to GND (Disable Mode):		0.01	1	μA
V _{EN}	Enable Voltage	Regulator becomes enabled	1.5			V
V _{DIS}	Disable Voltage	Regulator enters shutdown			0.4 0.18	V V
I _{EN}	Enable Input Current				0.01	μA
E _{NOISE}	Output Noise Voltage	BW=10Hz-100kHz; C _{OUT} = 2.2μF; C _{BYP} = 0.1μF		30		μVrms
t _{ON}	V _{OUT} Turn-on Time	C _{BYP} = 0μF; C _{OUT} = 2.2μF		80		μS
		C _{BYP} = 0.1μF; C _{OUT} = 2.2μF		100		μS
I _{LIM}	Overload Current Limit			800		mA
I _{SC}	Short Circuit Current Limit	V _{OUT} < 0.5V		550		mA
T _{JSD}	Thermal Shutdown Junction Temperature			165		°C
T _{HYST}	Thermal Hysteresis			20		°C

Note 1: V_{OUT}+1V < V_{IN} & 2.5V < V_{IN} < 6V, I_{OUT}=1mA, C_{IN}=2.2μF, T_J=25°C, unless specified otherwise. **Bold values indicate -40°C < T_J < 125°C**

Note 2: Tantalum, electrolytic or low ESR ceramic capacitors may be used for C_{OUT}.

Note 3: Regulation voltages and dropout resistance is measured at constant junction temperature using low duty cycle pulse testing.

Note 4: Line regulation is displayed as the average regulation across the full operating range measured in %/V.

THERMAL PERFORMANCE		
PACKAGE	θ _{JA} MINIMUM FOOTPRINT	θ _{JA} 1" SQUARE 20Z. COPPER
SOT23-5	220°C/W	170°C/W

Performance Information

Typical DC Characteristics (nominal conditions unless otherwise specified, CM3016-48ST Only)

$C_{IN} = 2.2\mu F$, $C_{OUT} = 2.2\mu F$, No C_{BYP} , $V_{IN} = 5.75V$, Load = 5mA

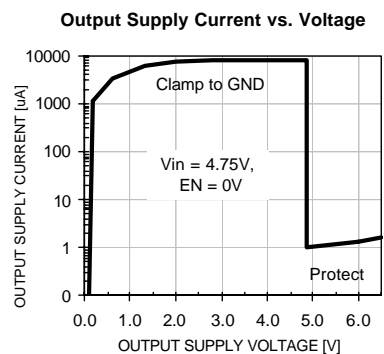
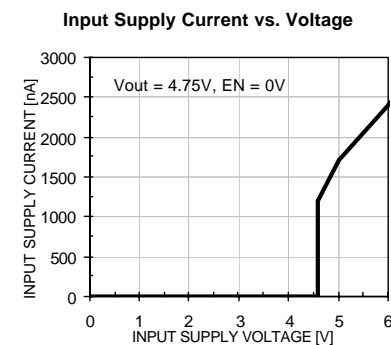
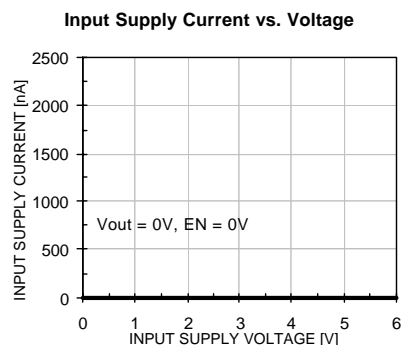
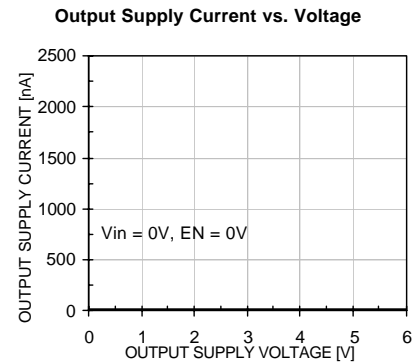
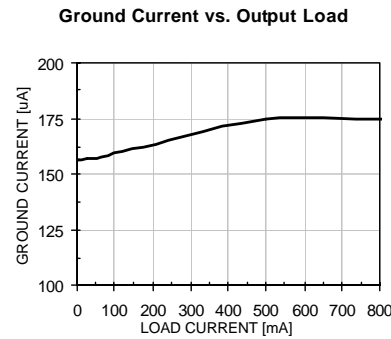
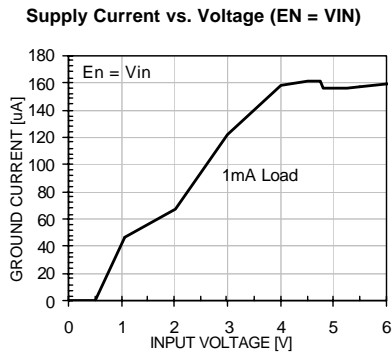
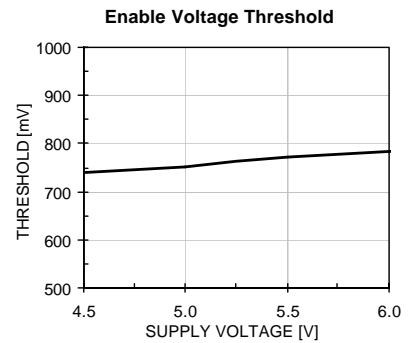
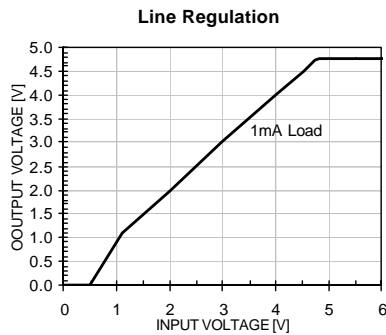
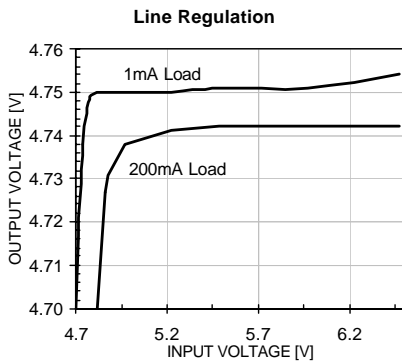
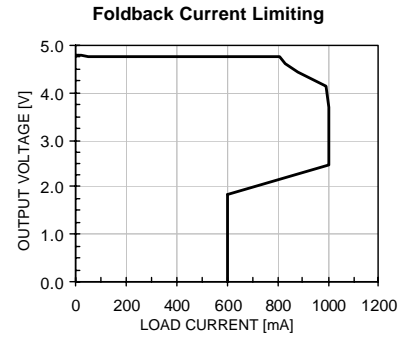
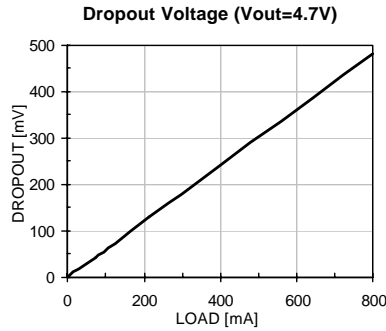
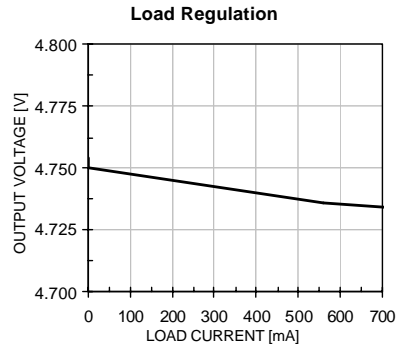

Performance Information (cont'd)

Transient Characteristics (nominal conditions unless otherwise specified, CM3016-48ST Only)

$C_{IN} = 2.2\mu F$, $C_{OUT} = 2.2\mu F$, $C_{BYP} = 0.1\mu F$, $V_{IN} = 5.0V$, Load = 5mA,

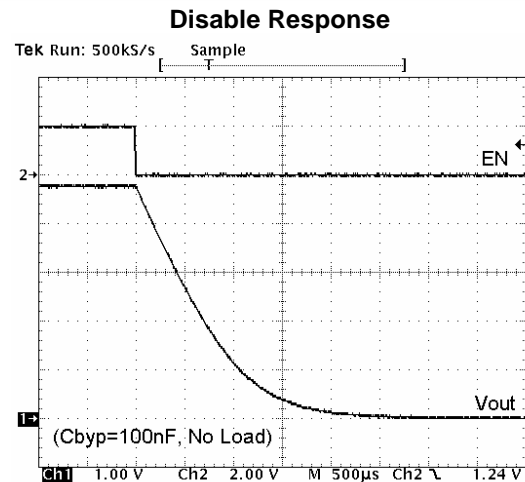
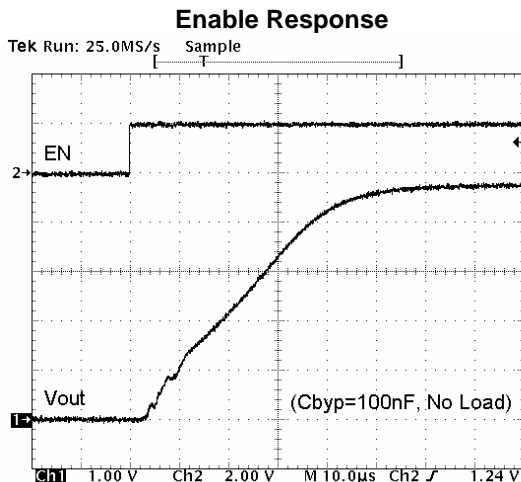
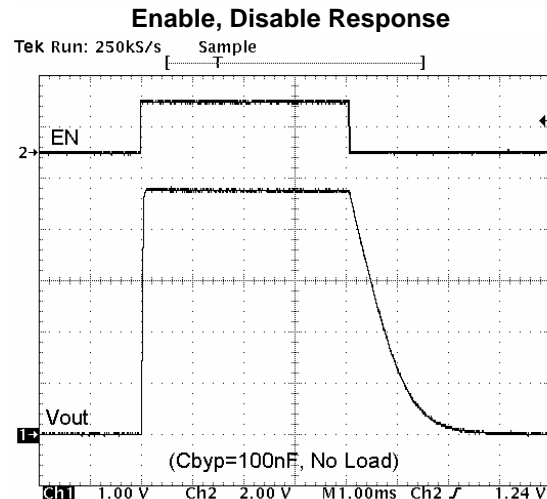
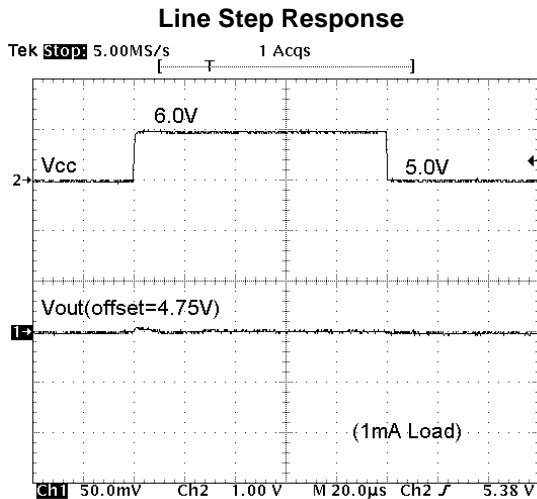
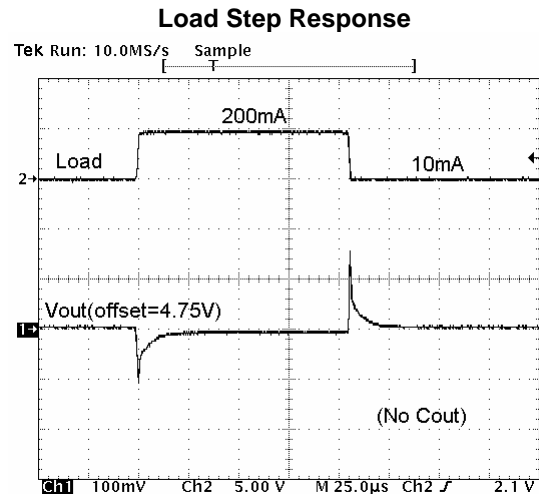
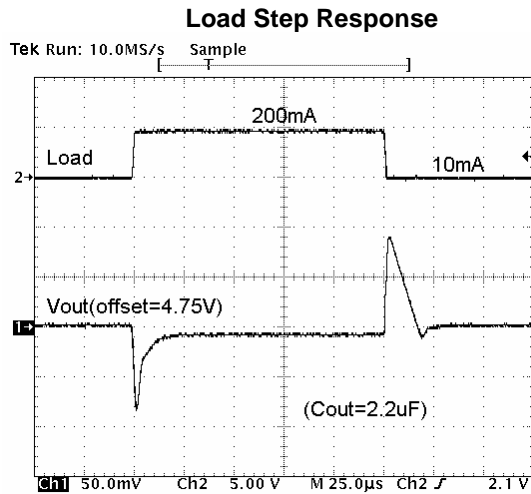

Performance Information (cont'd)

Power Supply Ripple Rejection (nominal conditions unless otherwise specified, CM3016-48ST Only)

$C_{IN} = 1\mu F$, $V_{IN} = 5.0V$, Load = 5mA, PSRR measured with 10mV pk-pk sin wave on V_{IN} .

PSRR ($V_{IN}-V_{OUT} = 500mV$)

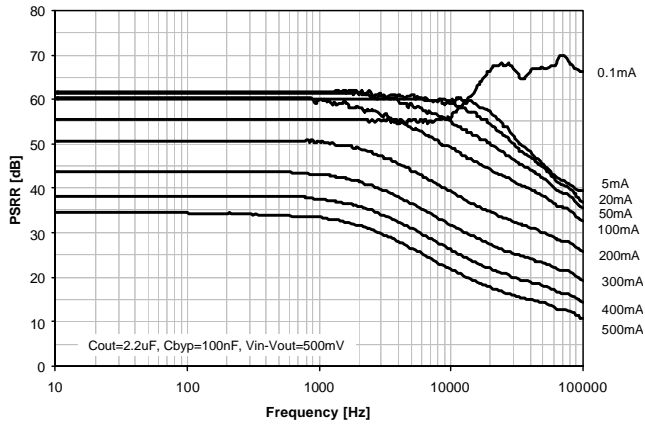

PSRR ($V_{IN}-V_{OUT} = 250mV$)

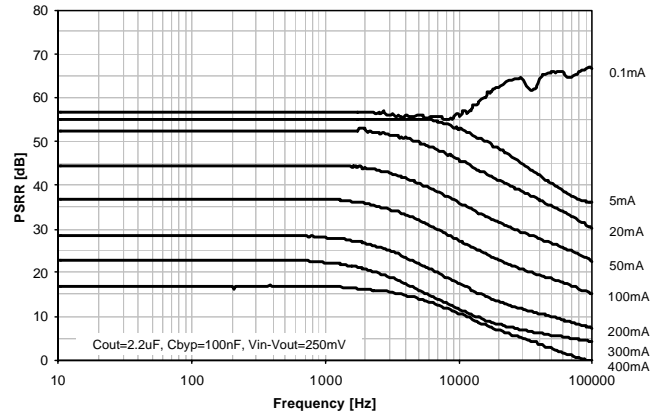

PSRR ($V_{IN}-V_{OUT} = 200mV$)

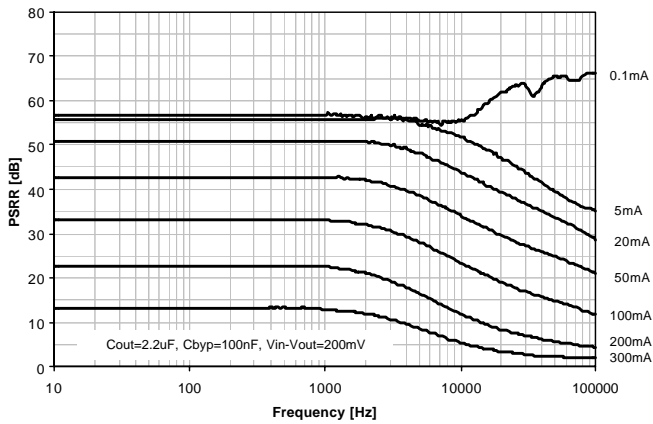

PSRR ($V_{IN}-V_{OUT} = 175mV$)

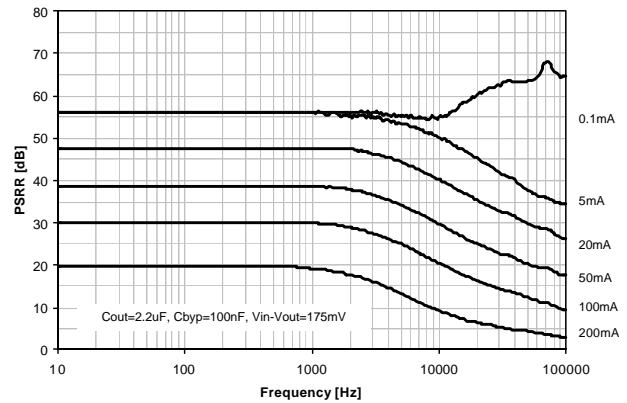

Performance Information (cont'd)

Power Supply Ripple Rejection (nominal conditions unless otherwise specified, CM3016-48ST Only)

$C_{IN} = 1\mu F$, $V_{IN} = 5.0V$, Load = 5mA, PSRR measured with 10mV pk-pk sin wave on V_{IN} .

PSRR ($V_{IN}-V_{OUT} = 150mV$)

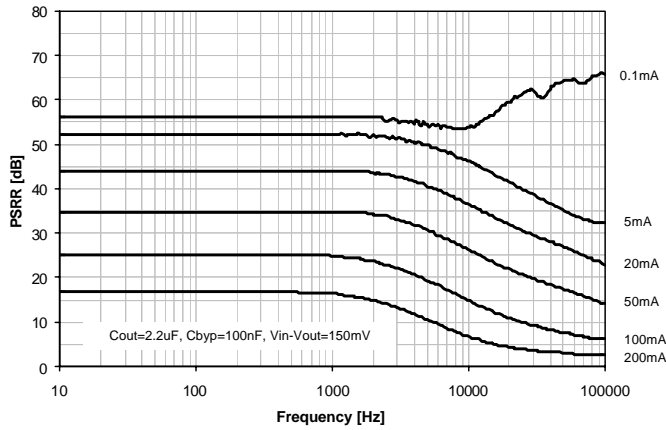

PSRR ($V_{IN}-V_{OUT} = 125mV$)

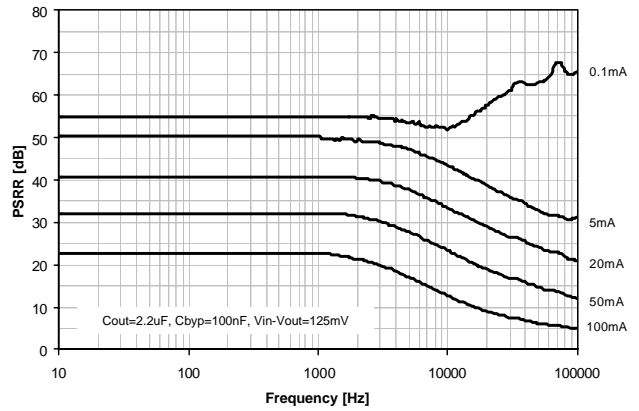

PSRR ($V_{IN}-V_{OUT} = 100mV$)

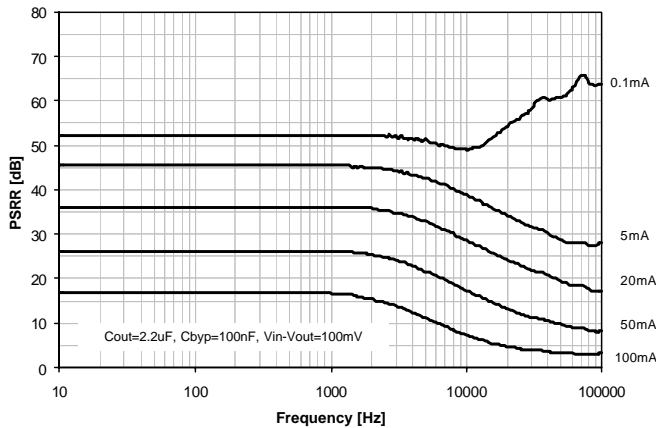

Performance Information (cont'd)

Typical Thermal Characteristics (nominal conditions unless otherwise specified, CM3016-48ST Only)

$C_{IN} = 2.2\mu F$, $C_{OUT} = 2.2\mu F$, No C_{BYP} , $V_{IN} = 5.0V$, Load = 5mA.

VOUT vs. Temperature (200mA Load)

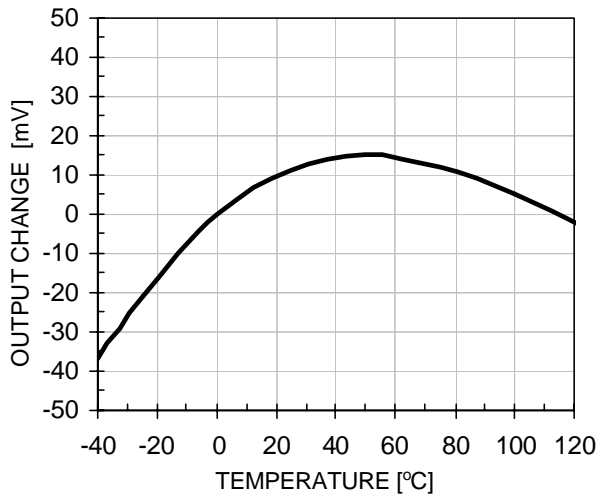

VOUT vs. Temperature

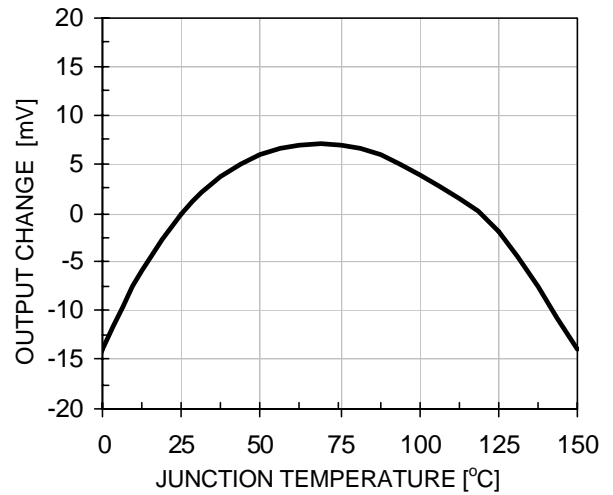

Ignd vs. Temperature

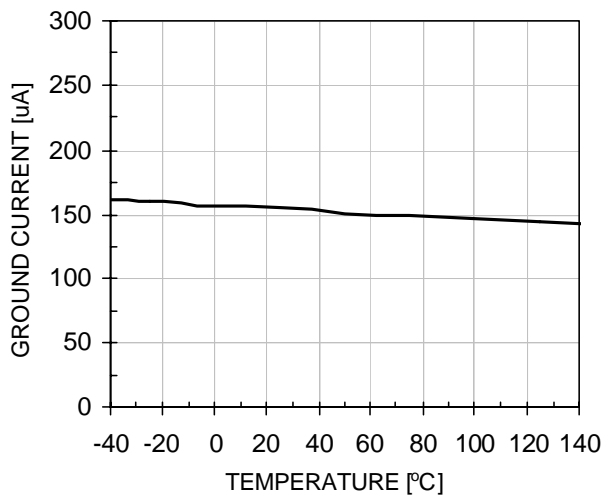

Dropout Resistance vs. Temperature

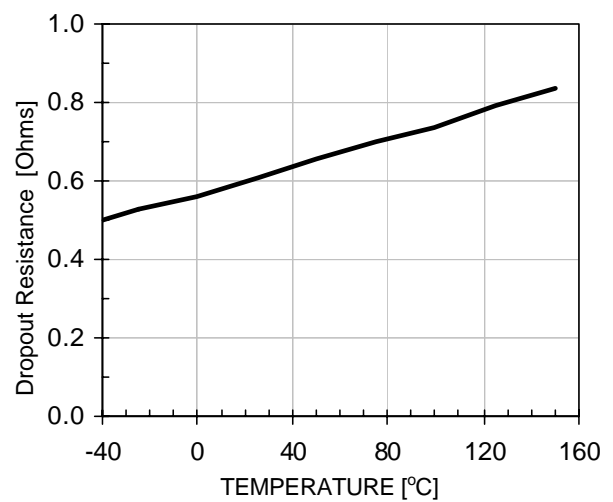

Mechanical Details

The CM3016-48 is available in a 5-pin SOT23 package. Dimensions for this package is presented below.

SOT23-5 Mechanical Specifications

Dimensions for CM3016-48ST/SO devices packaged in a 5-pin SOT23 package are presented below.

For complete information on the SOT23 package, see the California Micro Devices SOT23 Package Information document.

PACKAGE DIMENSIONS				
Package	SOT23 (JEDEC name is MO-178)			
Pins	5			
Dimensions	Millimeters		Inches	
	Min	Max	Min	Max
A	--	1.45	--	0.057
A1	0.00	0.15	0.000	0.006
b	0.30	0.50	0.012	0.020
c	0.08	0.22	0.003	0.009
D	2.75	3.05	0.108	0.120
E	2.60	3.00	0.102	0.118
E1	1.45	1.75	0.057	0.069
e	0.95 BSC		0.0374 BSC	
e1	1.90 BSC		0.0748 BSC	
L	0.60 REF		0.0236 REF	
# per tape and reel	3000 pieces			
Controlling dimension: inches				

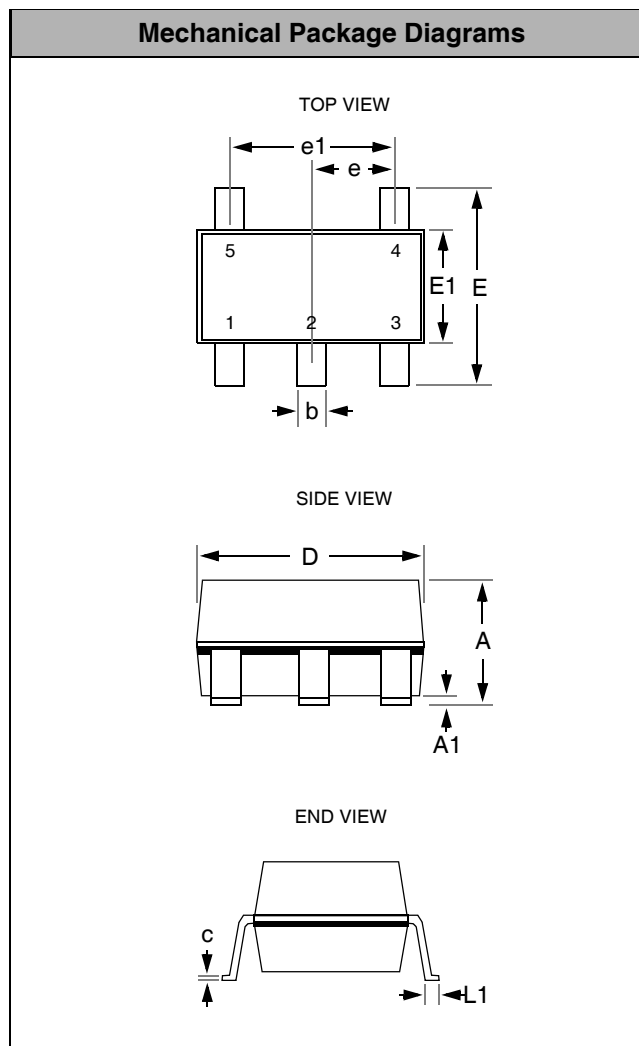

Package Dimensions for SOT23-5.