

Major Ratings and Characteristics

Characteristics	15MQ040N	Units
I_F DC	3	A
V_{RRM}	40	V
I_{FSM} @ $t_p = 5 \mu s$ sine	330	A
V_F @ $2A_{pk}, T_J = 125^\circ C$	0.43	V
T_J range	-40 to 150	$^\circ C$

Description/ Features

The 15MQ040N Schottky rectifier is designed to be used for low-power applications where a reverse voltage of 40 volts is encountered and surface mountable is required.

Applications

- Switching power supplies
- Meter protection
- Reverse protection for power input to PC board circuits
- Battery isolation and charging
- Low threshold voltage diode
- Free-wheeling or by-pass diode
- Low voltage clamp

Features

- Surface mountable
- Extremely low forward voltage
- Improved reverse blocking voltage capability relative to other similar size Schottky
- Compact size

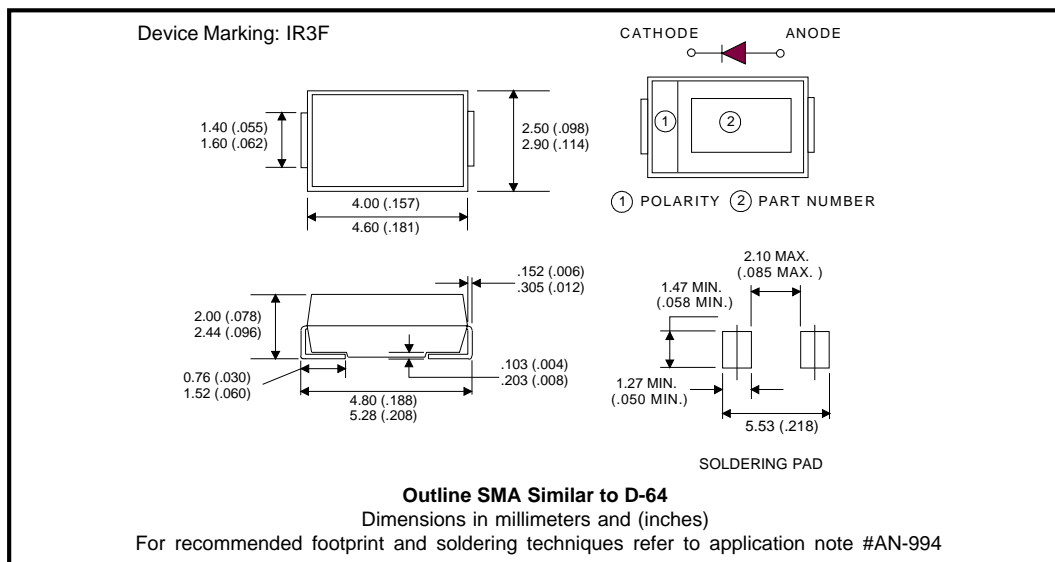

Voltage Ratings

Part number	15MQ040N
V_R Max. DC Reverse Voltage (V)	40
V_{RWM} Max. Working Peak Reverse Voltage (V)	

Absolute Maximum Ratings

Parameters	15MQ	Units	Conditions
$I_{F(AV)}$ Max. Average Forward Current * See Fig. 4	2.1	A	50% duty cycle @ $T_L = 105^\circ\text{C}$, rectangular wave form. On PC board 9mm ² island (.013mm thick copper pad area)
I_{FSM} Max. Peak One Cycle Non-Repetitive Surge Current * See Fig. 6	330	A	Following any rated load condition and with rated V_{RWM} applied
	140		
E_{AS} Non-Repetitive Avalanche Energy	6.0	mJ	$T_J = 25^\circ\text{C}$, $I_{AS} = 1\text{A}$, $L = 12\text{mH}$
I_{AR} Repetitive Avalanche Current	1.0	A	

Electrical Specifications

Parameters	15MQ	Units	Conditions
V_{FM} Max. Forward Voltage Drop (1) * See Fig. 1	0.42	V	@ 1A
	0.49	V	@ 2A
	0.34	V	@ 1A
	0.43	V	@ 2A
I_{RM} Max. Reverse Leakage Current (1) * See Fig. 2	0.5	mA	$T_J = 25^\circ\text{C}$
	20	mA	$T_J = 125^\circ\text{C}$
$V_{F(TO)}$ Threshold Voltage	0.26	V	$T_J = T_J \text{ max.}$
r_t Forward Slope Resistance	64.6	m Ω	
C_T Typical Junction Capacitance	134	pF	$V_R = 10V_{DC}$, $T_J = 25^\circ\text{C}$, test signal = 1Mhz
L_S Typical Series Inductance	2.0	nH	Measured lead to lead 5mm from package body
dv/dt Max. Voltage Rate of Change	10000	V/ μs	(Rated V_R)

(1) Pulse Width < 300 μs , Duty Cycle < 2%

Thermal-Mechanical Specifications

Parameters	15MQ	Units	Conditions
T_J Max. Junction Temperature Range (*)	-40 to 150	$^\circ\text{C}$	
T_{stg} Max. Storage Temperature Range	-40 to 150	$^\circ\text{C}$	
R_{thJA} Max. Thermal Resistance Junction to Ambient	80	$^\circ\text{C}/\text{W}$	DC operation
wt Approximate Weight	0.07(0.002)	g(oz.)	
Case Style	SMA		Similar D-64
Device Marking	IR3F		

(*) $\frac{dP_{tot}}{dT_J} < \frac{1}{R_{th(j-a)}}$ thermal runaway condition for a diode on its own heatsink

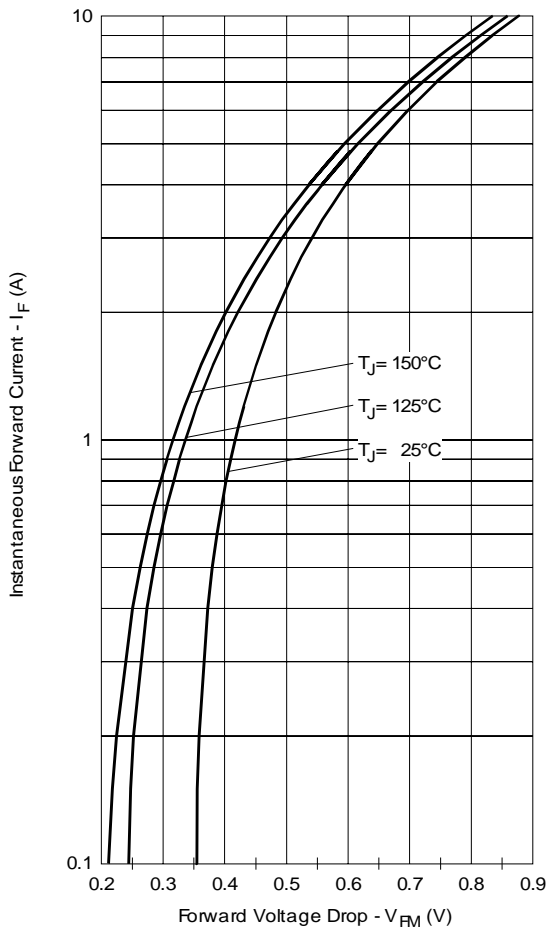

Fig. 1 - Maximum Forward Voltage Drop Characteristics

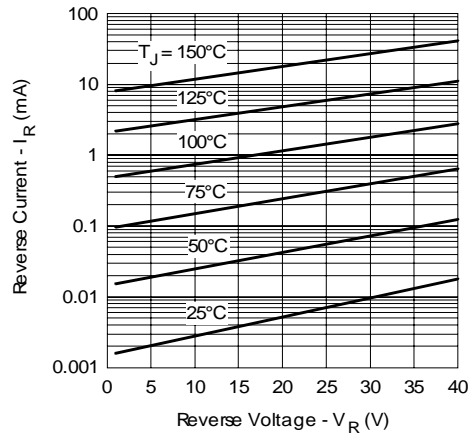

Fig. 2 - Typical Peak Reverse Current Vs. Reverse Voltage

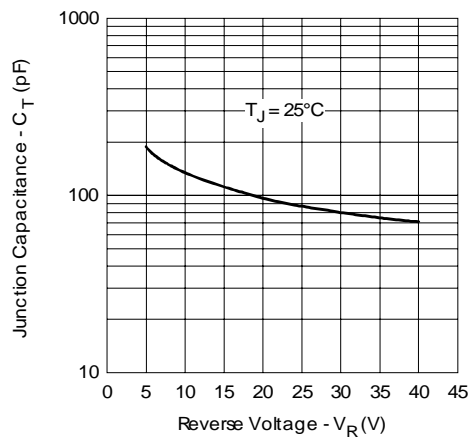

Fig. 3 - Typical Junction Capacitance Vs. Reverse Voltage

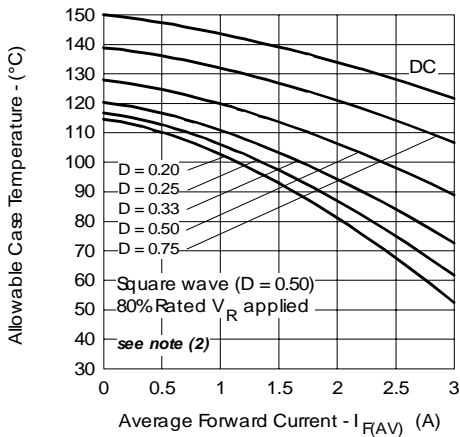

Fig. 4 - Maximum Average Forward Current Vs. Allowable Lead Temperature

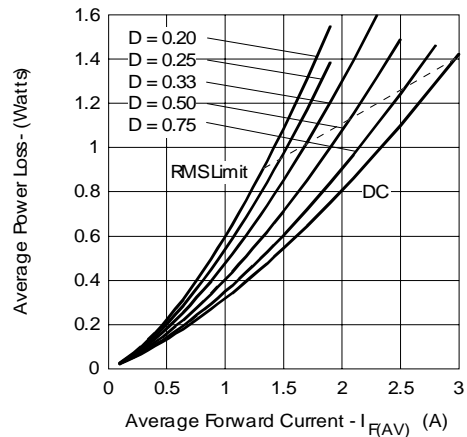

Fig. 5 - Maximum Average Forward Dissipation Vs. Average Forward Current

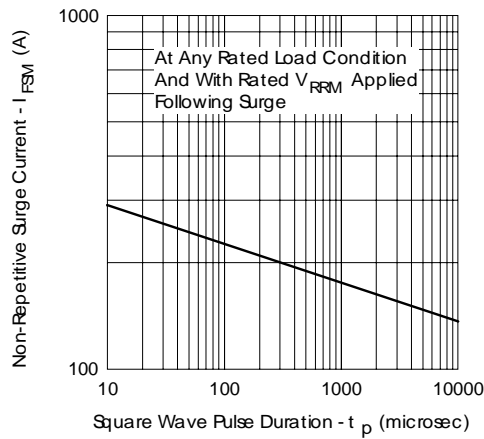

Fig. 6 - Maximum Peak Surge Forward Current Vs. Pulse Duration

(2) Formula used: $T_c = T_j - (Pd + Pd_{REV}) \times R_{thJC}$;

Pd = Forward Power Loss = $I_{F(AV)} \times V_{FM}$ @ $(I_{F(AV)} / D)$ (see Fig. 6);

Pd_{REV} = Inverse Power Loss = $V_{R1} \times I_R (1 - D)$; I_R @ V_{R1} = 80% rated V_R

Tape & Reel Information

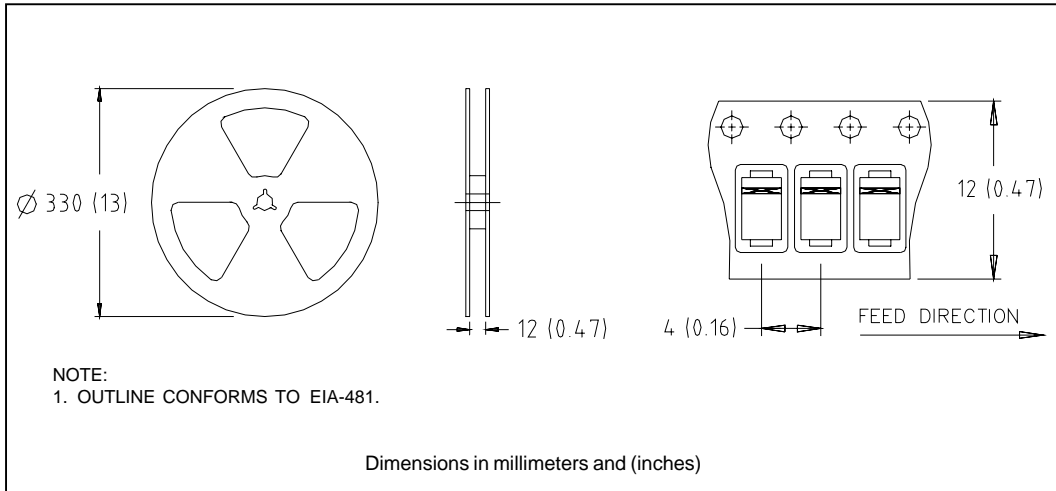

Marking & Identification

Each device has 2 rows for identification. The first row designates the device as manufactured by International Rectifier as indicated by the letters "IR", and the Part Number (indicates the current and the voltage rating). The second row indicates the year, the week of manufacturing and the Site ID.

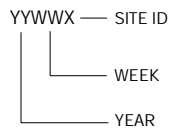
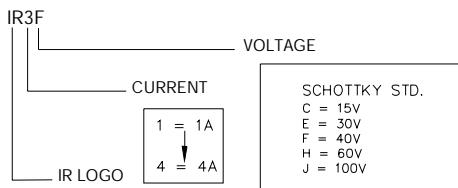

Ordering Information

15MQ SERIES - TAPE AND REEL

WHEN ORDERING, INDICATE THE PART NUMBER AND THE QUANTITY (IN MULTIPLES OF 7500 PIECES).

EXAMPLE: 15MQ040NTR - 15000 PIECES

15MQ SERIES - BULK QUANTITIES

WHEN ORDERING, INDICATE THE PART NUMBER AND THE QUANTITY (IN MULTIPLES OF 1000 PIECES).

EXAMPLE: 15MQ040N - 2000 PIECES

15MQ040N

Bulletin PD-20517 rev. G 03/03

International
IOR Rectifier

Data and specifications subject to change without notice.
This product has been designed and qualified for Industrial Level.
Qualification Standards can be found on IR's Web site.

International
IOR Rectifier

IR WORLD HEADQUARTERS: 233 Kansas St., El Segundo, California 90245, USA Tel: (310) 252-7105
TAC Fax: (310) 252-7309
Visit us at www.irf.com for sales contact information. 03/03