

**PNP Silicon AF Transistors**

- For general AF applications
- High collector current
- High current gain
- Low collector-emitter saturation voltage
- Complementary types: BC 817, BC 818 (NPN)

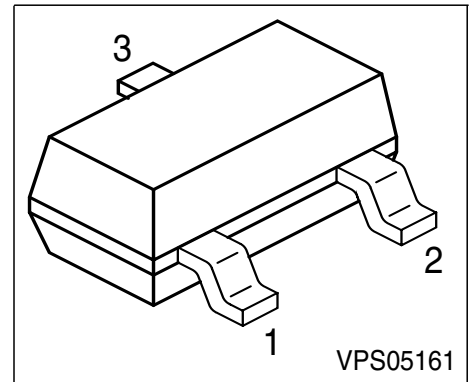

Type	Marking	Pin Configuration			Package
BC 807-16	5As	1 = B	2 = E	3 = C	SOT-23
BC 807-25	5Bs	1 = B	2 = E	3 = C	SOT-23
BC 807-40	5Cs	1 = B	2 = E	3 = C	SOT-23
BC 808-16	5Es	1 = B	2 = E	3 = C	SOT-23
BC 808-25	5Fs	1 = B	2 = E	3 = C	SOT-23
BC 808-40	5Gs	1 = B	2 = E	3 = C	SOT-23

**Maximum Ratings**

Parameter	Symbol	BC 807	BC 808	Unit
Collector-emitter voltage	$V_{CEO}$	45	25	V
Collector-base voltage	$V_{CBO}$	50	30	
Emitter-base voltage	$V_{EBO}$	5	5	
DC collector current	$I_C$	500		mA
Peak collector current	$I_{CM}$	1		A
Base current	$I_B$	100		mA
Peak base current	$I_{BM}$	200		
Total power dissipation, $T_S = 79\text{ °C}$	$P_{tot}$	330		mW
Junction temperature	$T_j$	150		°C
Storage temperature	$T_{stg}$	-65 ... 150		

**Thermal Resistance**

Parameter	Symbol	BC 807	BC 808	Unit
Junction ambient <sup>1)</sup>	$R_{thJA}$	≤285		K/W
Junction - soldering point	$R_{thJS}$	≤215		

1) Package mounted on pcb 40mm x 40mm x 1.5mm / 6cm<sup>2</sup> Cu

**Electrical Characteristics** at  $T_A = 25^\circ\text{C}$ , unless otherwise specified.

Parameter	Symbol	Values			Unit	
		min.	typ.	max.		
<b>DC Characteristics</b>						
Collector-emitter breakdown voltage $I_C = 10\text{ mA}, I_B = 0$	$V_{(BR)CEO}$	BC 807	45	-	-	V
BC 808		25	-	-		
Collector-base breakdown voltage $I_C = 10\text{ }\mu\text{A}, I_B = 0$	$V_{(BR)CBO}$	BC 807	50	-	-	
BC 808		30	-	-		
Emitter-base breakdown voltage $I_E = 10\text{ }\mu\text{A}, I_C = 0$	$V_{(BR)EBO}$		5	-	-	
Collector cutoff current $V_{CB} = 25\text{ V}, I_E = 0$	$I_{CBO}$		-	-	100	nA
Collector cutoff current $V_{CB} = 25\text{ V}, I_E = 0, T_A = 150\text{ }^\circ\text{C}$	$I_{CBO}$		-	-	50	$\mu\text{A}$
Emitter cutoff current $V_{EB} = 4\text{ V}, I_C = 0$	$I_{EBO}$		-	-	100	nA
DC current gain 1) $I_C = 100\text{ mA}, V_{CE} = 1\text{ V}$	$h_{FE}$	$h_{FE}$ -grp. <b>16</b>	100	160	250	-
		$h_{FE}$ -grp. <b>25</b>	160	250	400	
		$h_{FE}$ -grp. <b>40</b>	250	350	630	
DC current gain 1) $I_C = 300\text{ mA}, V_{CE} = 1\text{ V}$	$h_{FE}$	$h_{FE}$ -grp. <b>16</b>	60	-	-	
		$h_{FE}$ -grp. <b>25</b>	100	-	-	
		$h_{FE}$ -grp. <b>40</b>	170	-	-	
Collector-emitter saturation voltage1) $I_C = 500\text{ mA}, I_B = 50\text{ mA}$	$V_{CEsat}$		-	-	0.7	V
Base-emitter saturation voltage 1) $I_C = 500\text{ mA}, I_B = 50\text{ mA}$	$V_{BEsat}$		-	-	1.2	V

 1) Pulse test:  $t \leq 300\text{ }\mu\text{s}$ ,  $D = 2\%$

**Electrical Characteristics** at  $T_A = 25^\circ\text{C}$ , unless otherwise specified.

Parameter	Symbol	Values			Unit
		min.	typ.	max.	
<b>AC Characteristics</b>					
Transition frequency $I_C = 50 \text{ mA}$ , $V_{CE} = 5 \text{ V}$ , $f = 100 \text{ MHz}$	$f_T$	-	200	-	MHz
Collector-base capacitance $V_{CB} = 10 \text{ V}$ , $f = 1 \text{ MHz}$	$C_{cb}$	-	10	-	pF
Emitter-base capacitance $V_{EB} = 0.5 \text{ V}$ , $f = 1 \text{ MHz}$	$C_{eb}$	-	60	-	

**Total power dissipation  $P_{tot} = f(T_A^*; T_S)$**

\* Package mounted on epoxy

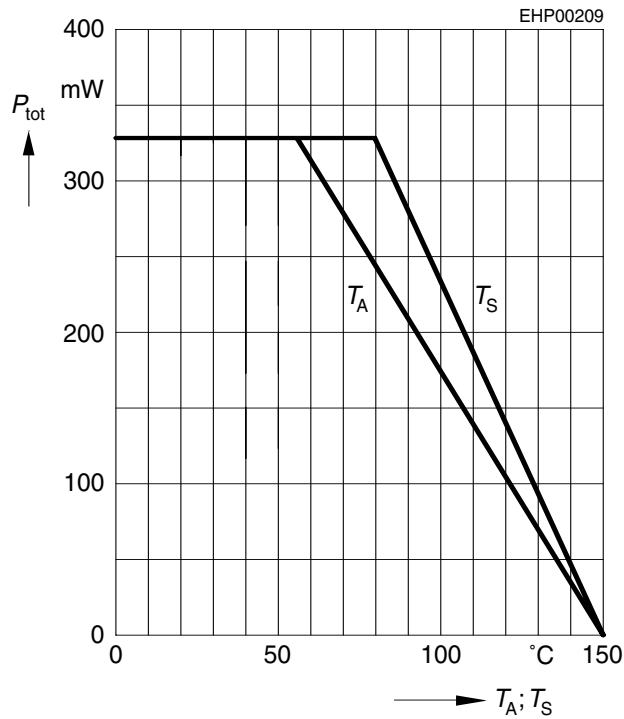

**Transition frequency  $f_T = f(I_C)$**

$V_{CE} = 5V$

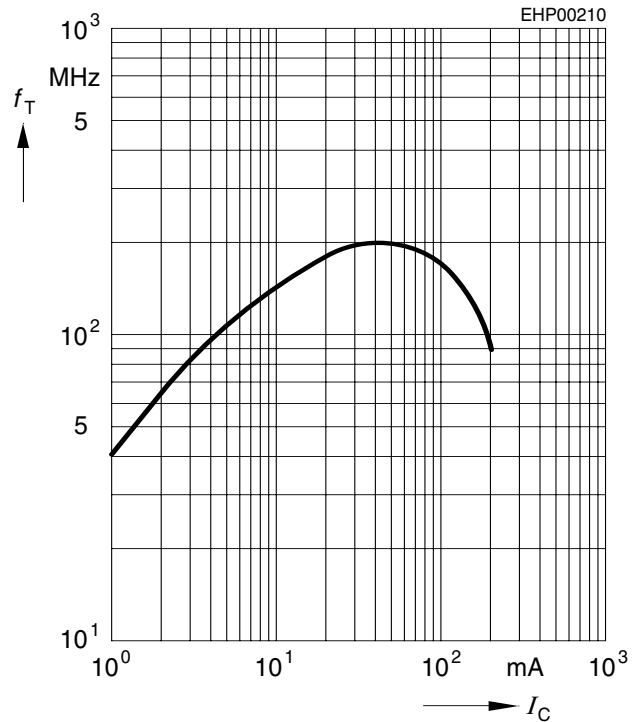

**Permissible pulse load**

$P_{totmax} / P_{totDC} = f(t_p)$

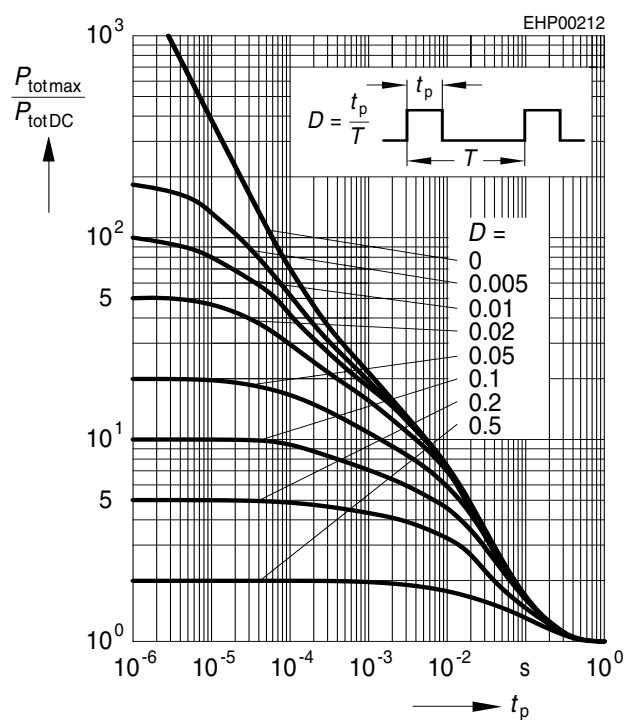

**Collector cutoff current  $I_{CBO} = f(T_A)$**

$V_{CBO} = 25V$

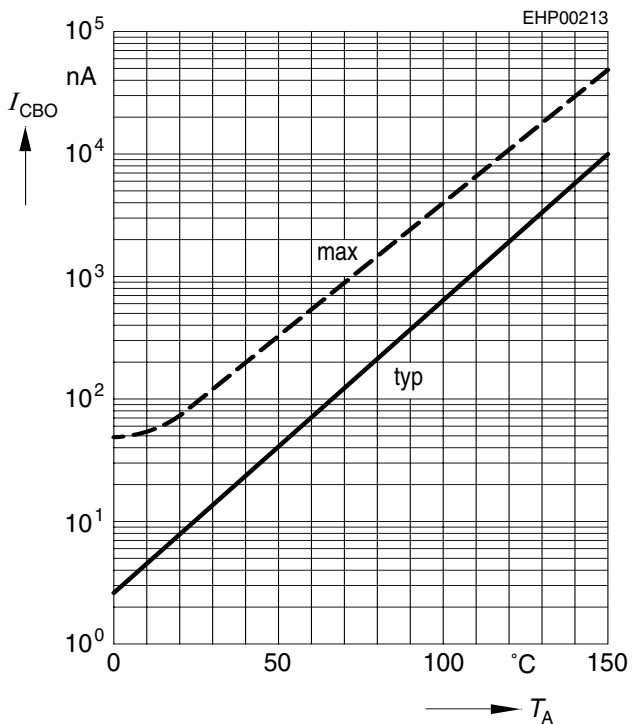

**Base-emitter saturation voltage**

$I_C = f(V_{BEsat}), h_{FE} = 10$

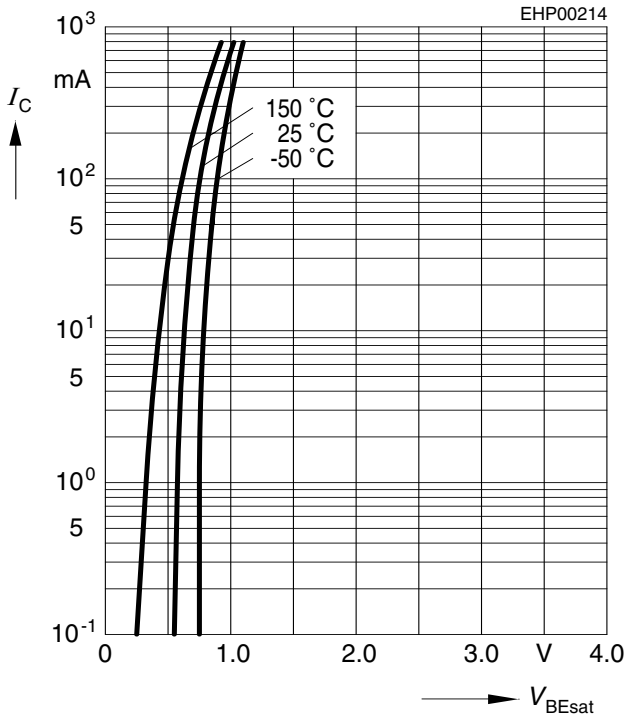

**Collector-emitter saturation voltage**

$I_C = f(V_{CEsat}), h_{FE} = 10$

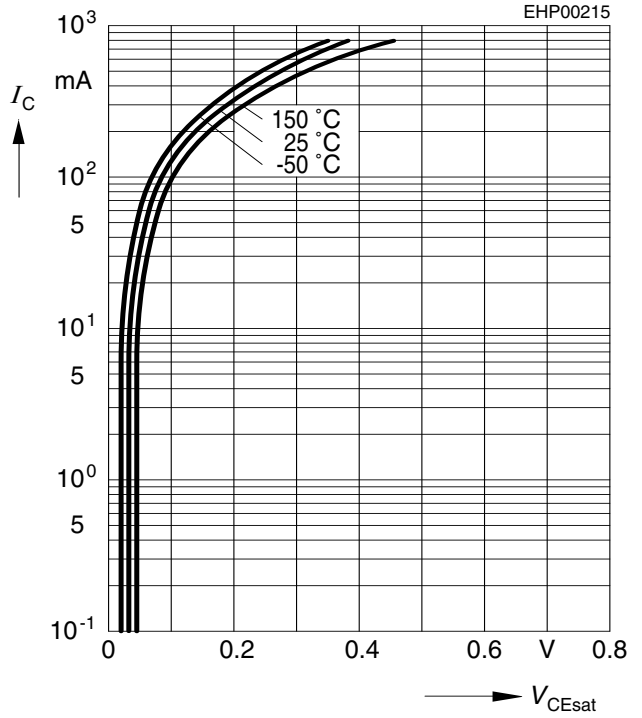

**DC current gain  $h_{FE} = f(I_C)$**

$V_{CE} = 1V$

