

FEATURES

- -55° to +125°C operation
- 12 to 50 VDC input
- Fully Isolated
- Magnetic feedback
- Fixed frequency 370 kHz typical
- Topology – Current Mode Flyback
- 80 V for up to 120 ms transient protection (70 V for 15 V single and dual models)
- Inhibit function
- Indefinite short circuit protection
- Up to 79% efficiency

DC/DC CONVERTERS 28 VOLT INPUT

MGH SERIES 1.5 WATT

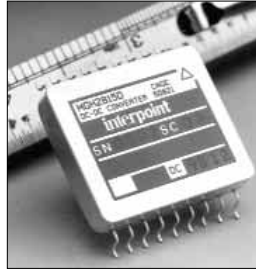

MODELS	
VDC OUTPUT	
SINGLE	DUAL
5	±5
12	±12
15	±15

Size (max.): 1.010 x 0.880 x 0.250 inches (25.65 x 22.35 x 6.35 mm)
Shown with "Gull Wing" lead option, also available with straight leads. See Section B8, case B, for dimensions and options.

Weight: 12 grams maximum

Screening: Standard, ES, or 883 (Class H). See Section C2 for screening options, see Section A5 for ordering information.

DESCRIPTION

The MGH Series™ of DC/DC converters delivers 1.5 watts of output power in a labor saving surface mount package. The wide input voltage range of 12 to 50 VDC accepts the varying voltages of military, aerospace, or space applications. Single output converters feature outputs of 5, 12, or 15 volts while dual output models feature outputs of ±5, ±12, or ±15 volts. Transient protection of 80 volts for up to 120 milliseconds exceeds the requirements of MIL-STD-704A for the 5 and 12 volt single and dual models. The 15 volt single and dual converters will withstand transients of up to 70 volts for up to 120 milliseconds.

CONVERTER DESIGN

MGH Series DC/DC converters incorporate a continuous flyback topology with a constant switching frequency of approximately 370 kHz. Output voltage regulation is accomplished on the primary side using current-mode pulse width modulation (PWM). Regulation is affected by the output load; refer to the specifications tables for more information.

For dual output models, up to 80% of the total load may be on one output providing the other output carries a minimum of 20% of the total load. The dual models can be used at double the output voltage by connecting the load between positive and negative outputs, leaving the common unconnected. As an example the MGH2805D (5 volt dual output) can be used as a 10 VDC output.

INHIBIT FUNCTION

When an open collector TTL logic low is applied to the inhibit terminal, pin 18, the converter shuts down and lowers the output voltage to near zero and input current to as low 2.3 mA. Leaving the terminal open or applying an open collector TTL logic high will enable the converter.

PROTECTION FEATURES

Undervoltage lockout prevents the MGH Series converters from operating below approximately 8 VDC input voltage to keep system current levels smooth, especially during initialization or re-start operations. All models include a soft-start function to prevent large current draw and minimize overshoot. The MGH Series of converters also provide short circuit protection by limiting the current to approximately 125% of full load.

MIL-STD-461

Use Interpoint's FMGA-461 EMI filter to pass the CE03 requirements of MIL-STD-461C.

SURFACE MOUNT PACKAGE

MGH DC/DC converters can be surface mounted with pick-and-place equipment or manually. It is recommended that the case be attached with flexible epoxy adhesive or silicone which is thermally conductive (>1 watt /meter²K).

Internal components are soldered with SN96 (melting temperature 221°C) to prevent damage during reflow. Maximum reflow temperature for surface mounting the MGH converter is 220°C for a maximum of 30 seconds. SN60, 62, or 63 are the recommended types of solder. Hand soldering should not exceed 300°C for 10 seconds per pin.

The hermetically sealed metal cases are available in two different lead configurations. See Section B8, case B.

CRANE

interpoint

A CRANE CO. COMPANY

MGH SERIES 1.5 WATT

DC/DC CONVERTERS

ABSOLUTE MAXIMUM RATINGS	
Input Voltage	• 12 to 50 V
Output Power	• 1.5 watts
Capacitive Load	• 200 μ F single output models • 100 μ F each output, dual output models
Lead Soldering Temperature	• Reflow 220°C 30 sec. max SN60, 62 or 63 recommended solder
Storage Temperature Range (Case)	• -65°C to +150°C

INHIBIT	
Inhibit: TTL Open Collector	• Logic low (output disabled) Logic low voltage ≤ 0.8 V Inhibit pin current 1 mA max
	• Referenced to input common
	• Logic high (output enabled) open collector

RECOMMENDED OPERATING CONDITIONS	
Input Voltage Range	• 12 to 50 VDC continuous • 80 V for 120 msec transient (70 V for 15 V single and dual models)
Case Operating Temperature (Tc)	• -55°C to +125°C full power • -55°C to +135°C absolute
Derating Output Power/Current	• Linearly from 100% at 125°C to 0% at 135 C

TYPICAL CHARACTERISTICS	
Output Voltage Temperature Coefficient	• 100 ppm/°C typical
Input to Output Capacitance	• 100 to 170 pF typical
Undervoltage Lockout	• 8 V input typical
Current Limit	• 125% of full load typical
Isolation	• 100 megohm minimum at 500 V
Conversion Frequency (kHz)	• 25°C 300 min, 370 typ, 450 max • -55°C to +125°C 270 min, 370 typ, 470 max
Inhibit Pin Voltage (unit enabled)	• 7 to 12 V

Electrical Characteristics: 25°C Tc, 28 VDC Vin, 100% load, unless otherwise specified.

SINGLE OUTPUT MODELS		MGH2805S			MGH2812S			MGH2815S			UNITS
PARAMETER	CONDITIONS	MIN	TYP	MAX	MIN	TYP	MAX	MIN	TYP	MAX	
OUTPUT VOLTAGE ¹	Tc = 25°C	4.95	5	5.05	11.88	12	12.12	14.85	15	15.15	VDC
	Tc = -55°C TO +125°C	4.80	5	5.20	11.52	12	12.48	14.40	15	15.60	
OUTPUT CURRENT	V _{IN} = 12 to 50 VDC	0	—	300	0	—	125	0	—	100	mA
OUTPUT POWER	V _{IN} = 12 to 50 VDC	0	—	1.5	0	—	1.5	0	—	1.5	W
OUTPUT RIPPLE VOLTAGE	10 kHz - 2 MHz	—	45	150	—	50	200	—	35	150	mV p-p
	Tc = -55°C TO +125°C	—	65	300	—	70	300	—	50	250	
LINE REGULATION	V _{IN} = 12 to 50 VDC	—	35	100	—	60	200	—	70	300	mV
	Tc = -55°C TO +125°C	—	40	120	—	70	250	—	80	350	
LOAD REGULATION	10% TO FULL LOAD	—	350	700	—	600	1300	—	700	1500	mV
		Tc = -55°C TO +125°C	—	380	800	—	640	1400	—	760	
	50% TO FULL LOAD	—	100	200	—	145	300	—	165	350	
		Tc = -55°C TO +125°C	—	115	300	—	160	400	—	185	
INPUT VOLTAGE NO LOAD TO FULL	CONTINUOUS	12	28	50	12	28	50	12	28	50	VDC
	TRANSIENT 120 ms	0	—	80	0	—	80	0	—	70	V
INPUT CURRENT	NO LOAD	—	5.5	10	—	6.0	10	—	6.0	11	mA
	Tc = -55°C TO +125°C	—	6.0	11	—	6.5	12	—	6.5	12	
	FULL LOAD	—	70	74	—	68	72	—	68	72	
	Tc = -55°C TO +125°C	—	73	78	—	70	74	—	70	74	
INPUT RIPPLE CURRENT ²	10k Hz - 10 MHz	—	100	200	—	100	200	—	100	200	mA p-p
	Tc = -55°C TO +125°C	—	130	250	—	150	250	—	150	250	
EFFICIENCY	Tc = 25°C	72	77	—	74	79	—	74	79	—	%
	Tc = -55°C TO +125°C	69	75	—	72	77	—	72	77	—	
LOAD FAULT ^{3, 4}	POWER DISSIPATION	—	1.3	2.0	—	2.0	3.2	—	2.3	3.7	W
		Tc = -55°C TO +125°C	—	1.4	2.3	—	2.2	3.5	—	2.5	
	RECOVERY	—	3.0	12	—	3.5	15	—	4.0	18	ms
		Tc = -55°C TO +125°C	—	3.5	15	—	3.5	20	—	4.0	
STEP LOAD RESPONSE ⁵ 50%—100%—50%	TRANSIENT	-400	185	400	-700	350	700	-700	350	700	mV pk
	Tc = -55°C TO +125°C	-500	185	500	-800	380	800	-800	380	800	
STEP LINE RESPONSE ⁵ 12 TO 50 TO 12 V _{IN}	RECOVERY	—	125	500	—	130	500	—	140	600	μ s
	Tc = -55°C TO +125°C	—	125	600	—	130	600	—	180	750	
START-UP 0 TO 28 VDC	TRANSIENT	-400	170	400	-900	400	900	-750	400	750	mV pk
		Tc = -55°C TO +125°C	-500	180	500	-1000	400	1000	-850	450	
	RECOVERY	—	0.75	3.0	—	0.6	2.5	—	0.47	2.0	
		Tc = -55°C TO +125°C	—	0.75	4.0	—	0.6	3.0	—	0.5	
DELAY	—	7	20	—	7	20	—	7	20	ms	
	Tc = -55°C TO +125°C	—	10	40	—	10	40	—	10		40
	OVERSHOOT	—	0	100	—	0	250	—	0		300
	Tc = -55°C TO +1 25°C	—	0	150	—	0	350	—	0	450	mV pk

Notes

- Specified at 50% of full load.
- L_{in} = 2 μ H
- Max. duration of short circuit: 25°C— 90 seconds; 125°C— 30 seconds.

- Load fault is a short circuit (<50 mohms). Recovery into resistive full load.
- Input step transition ≥ 10 μ s. Recovery is time to settle to within 1% of V_{out} final value.

DC/DC CONVERTERS

MGH SERIES 1.5 WATT

Electrical Characteristics: 25°C Tc, 28 VDC Vin, 100% load, unless otherwise specified.

DUAL OUTPUT MODELS		MGH2805D			MGH2812D			MGH2815D			UNITS	
PARAMETER	CONDITIONS	MIN	TYP	MAX	MIN	TYP	MAX	MIN	TYP	MAX		
OUTPUT VOLTAGE ¹	Tc = 25°C	±4.95	±5	±5.05	±11.88	±12	±12.12	±14.85	±15	±15.15	VDC	
	Tc = -55°C TO +125°C	±4.80	±5	±5.20	±11.52	±12	±12.48	±14.40	±15	±15.60		
OUTPUT CURRENT ²	V _{IN} = 12 to 50 VDC	0	±150	240	0	±62.5	100	0	±50	80	mA	
OUTPUT POWER	V _{IN} = 12 to 50 VDC	0	—	1.5	0	—	1.5	0	—	1.5	W	
OUTPUT RIPPLE VOLTAGE	10 kHz - 2 MHz	—	35	150	—	35	150	—	30	150	mV p-p	
	+V _{OUT}	Tc = -55°C TO +125°C	—	50	250	—	40	250	—	35		250
	-V _{OUT}	10 kHz - 2 MHz	—	35	150	—	35	150	—	30		150
	Tc = -55°C TO +125°C	—	50	250	—	40	250	—	35	250		
LINE REGULATION ³	V _{IN} = 12 to 50 VDC	—	10	50	—	100	300	—	165	500	V	
	Tc = -55°C TO +125°C	—	20	100	—	110	400	—	180	650		
LOAD REGULATION ^{3, 4}	10% TO FULL LOAD	—	300	600	—	550	1100	—	600	1300	mV	
	-55°C TO +125°C	—	350	700	—	570	1200	—	630	1400		
	50% TO FULL LOAD	—	80	200	—	115	250	—	125	300		
	-55°C TO +125°C	—	100	300	—	130	350	—	135	400		
CROSS REGULATION ⁵	-V _{OUT}	—	—	400	—	—	500	—	—	500	mV	
INPUT VOLTAGE NO LOAD TO FULL	CONTINUOUS	12	28	50	12	28	50	12	28	50	VDC	
	TRANSIENT 120 ms	0	—	80	0	—	80	0	—	70	V	
INPUT CURRENT	NO LOAD	—	5.0	10	—	7.5	13	—	7.5	13	mA	
	Tc = -55°C TO +125°C	—	6.0	12	—	8.0	14	—	8.0	14		
	FULL LOAD	—	69	73	—	70	73	—	71	74		
	Tc = -55°C TO +125°C	—	72	77	—	71	77	—	72	78		
	INHIBITED	—	2.3	3.2	—	2.3	3.2	—	2.3	3.2		
Tc = -55°C TO +125°C	—	2.4	3.5	—	2.4	3.5	—	2.4	3.5			
INPUT RIPPLE ⁶ CURRENT	10 kHz - 10 MHz	—	100	200	—	115	200	—	90	200	mA p-p	
	Tc = -55°C TO +125°C	—	130	250	—	150	250	—	120	250		
EFFICIENCY	Tc = 25°C	73	77	—	73	77	—	72	76	—	%	
	Tc = -55°C TO +125°C	70	75	—	70	75	—	69	74	—		
LOAD FAULT ^{7,8}	POWER DISSIPATION	—	1.4	2.2	—	2.5	3.8	—	2.7	4.1	W	
	Tc = -55°C TO +125°C	—	1.6	2.5	—	2.7	4.2	—	3.0	4.5		
	RECOVERY	—	3.7	15	—	3.2	15	—	4.0	15	ms	
	Tc = -55°C TO +125°C	—	3.8	20	—	3.2	20	—	4.0	20		
STEP LOAD RESPONSE ⁹	TRANSIENT	-300	130	300	-600	250	600	-600	250	600	mV pk	
	Tc = -55°C TO +125°C	-400	140	400	-700	260	700	-700	270	700		
	RECOVERY	—	100	400	—	165	700	—	50	200	µs	
	±V _{out} 50%-100%-50%	-55°C TO +125°C	—	100	500	—	165	800	—	50		300
STEP LINE RESPONSE ¹⁹	TRANSIENT	-250	125	250	-500	240	500	-500	220	500	mV pk	
	Tc = -55°C TO +125°C	-300	130	300	-600	250	600	-600	230	600		
	RECOVERY	—	0.6	2.5	—	0.9	3.0	—	0.6	3.0	ms	
	±V _{out} 12 TO 50 TO 12 V _{IN}	Tc = -55°C TO +125°C	—	0.6	3.0	—	0.9	4.0	—	0.7		4.0
START-UP 0 TO 28 VDC, ±V _{out}	DELAY	—	8	25	—	8	25	—	8	25	ms	
	Tc = -55°C TO +125°C	—	10	45	—	10	45	—	10	45		
	OVERSHOOT	—	0	100	—	0	250	—	0	750	mV pk	
Tc = -55°C TO +125°C	—	0	150	—	0	350	—	0	900			

Notes:

- Specified at 50% load.
- Max. spec indicates 80% of the converter's total available power. This 80% is available from either output.
- Specification applies to both + and -V_{out}.
- Although no minimum load is required, at no load the output voltage may increase up to 15%.
- Cross regulation is specified as the effect on -V_{out} for the following percentages of total output power: +Po = 20% and -Po = 80% to +Po=80% and -Po=20%
- Lin = 2 µH.
- Max. duration of short circuit: 25°C – 90 seconds; 125°C – 30 seconds.
- Load fault is a short circuit (<50 mohms). Recovery into resistive full load.
- Input step transition ≥ 10 µs.Recovery is time to settle to within 1% of V_{out} final value.

MGH SERIES 1.5 WATT

DC/DC CONVERTERS

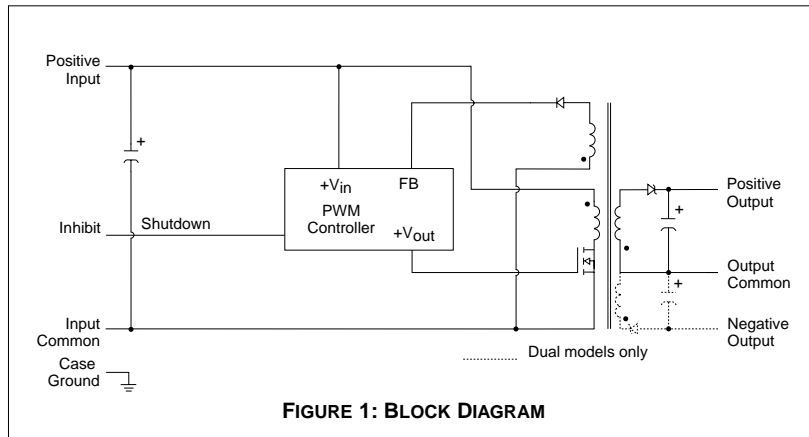

PIN OUT		
Pin	Single Output	Dual Output
1	Positive Input	Positive Input
2	No connection	No connection
3	Input Common	Input Common
4, 5	Positive Output	Positive Output
6, 7	Case Ground	Case Ground
8, 9	Output Common	Output Common
10, 11	Case Ground	Case Ground
12	No connection	No connection
13, 14	No connection	Negative Output
15, 16, 17	No connection	No connection
18	Inhibit	Inhibit

To meet specified performance, all pins must be connected except "No Connection" pins.

Differently colored glass bead around pin one or dimple in header (bottom or side of case) indicates pin one.
Cover marking is oriented with pin one at the upper right corner.

See Section B8, case B, for dimensions and "gull-wing" option.

FIGURE 2: PIN OUT

SMD NUMBERS	
STANDARD MICROCIRCUIT DRAWING (SMD)	MGH SERIES SIMILAR PART
5962-9569601HXC	MGH2805S/883
5962-9569701HXC	MGH2812S/883
5962-9569801HXC	MGH2815S/883
5962-9570201HXC	MGH2805D/883
5962-9570301HXC	MGH2812D/883
5962-9570401HXC	MGH2815D/883

For exact specifications for an SMD product, refer to the SMD drawing. Call your Interpoint representative for status on the MGH SMD releases. See Section A3, SMDs, for more information.

MODEL NUMBERING KEY

Base Model	MGH	28	12	S	Z / ES
Input Voltage					
Output Voltage					
Number of Outputs (S = single, D = dual)					
Gull Wing Lead Option (Straight leaded case has no designator in this position.)					
Screening (Standard screening has no designator in this position.)					

DC/DC CONVERTERS

MGH SERIES 1.5 WATT

Typical Performance Curves: 25°C Tc , 28 VDC Vin, 100% load, unless otherwise specified.

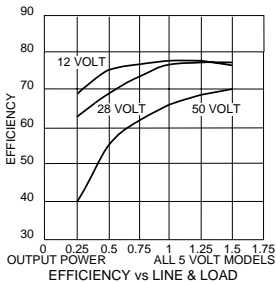

FIGURE 3

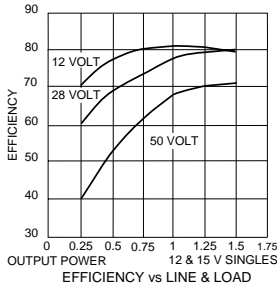

FIGURE 4

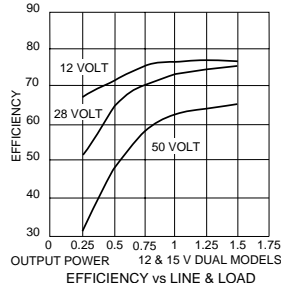

FIGURE 5

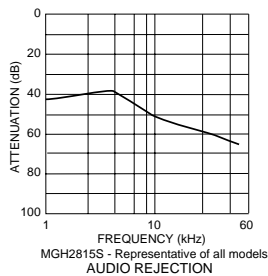

FIGURE 6

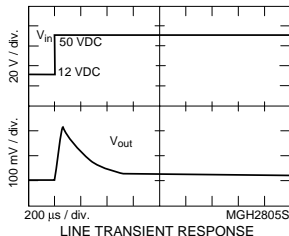

FIGURE 7

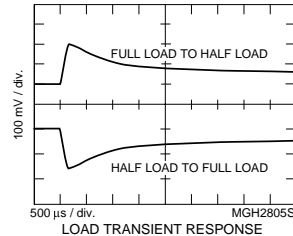

FIGURE 8

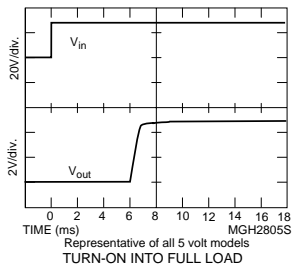

FIGURE 9

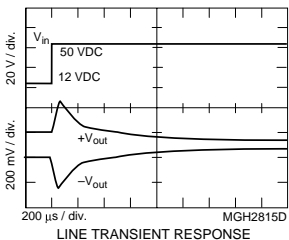

FIGURE 10

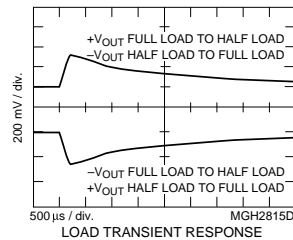

FIGURE 11

MGH SERIES 1.5 WATT

DC/DC CONVERTERS

Typical Performance Curves: 25°C Tc , 28 VDC Vin, 100% load, unless otherwise specified.

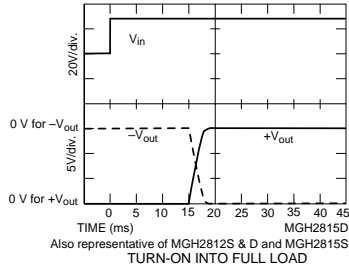

FIGURE 12

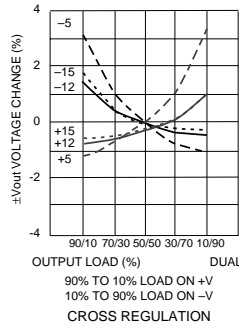

FIGURE 13

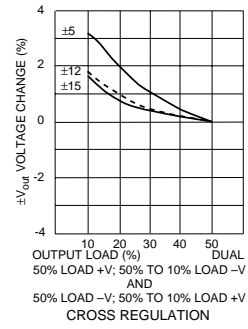

FIGURE 14

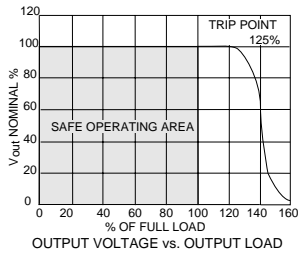
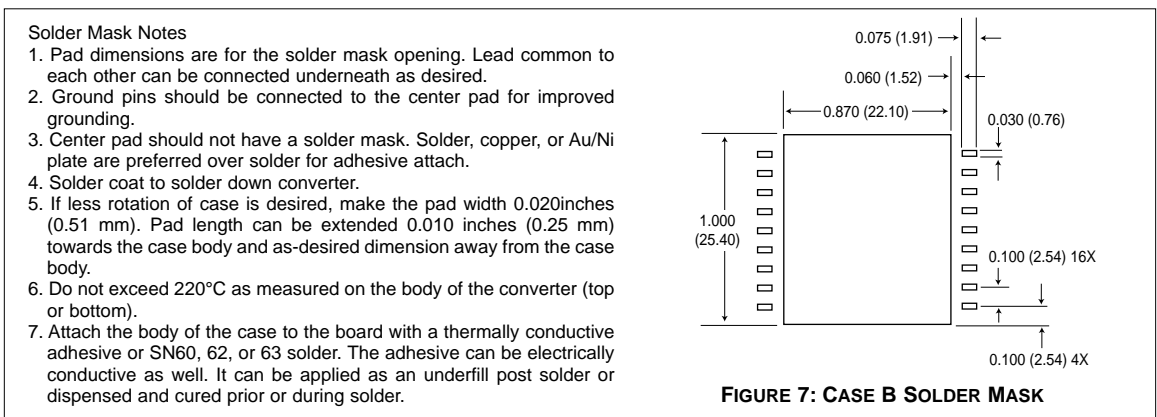
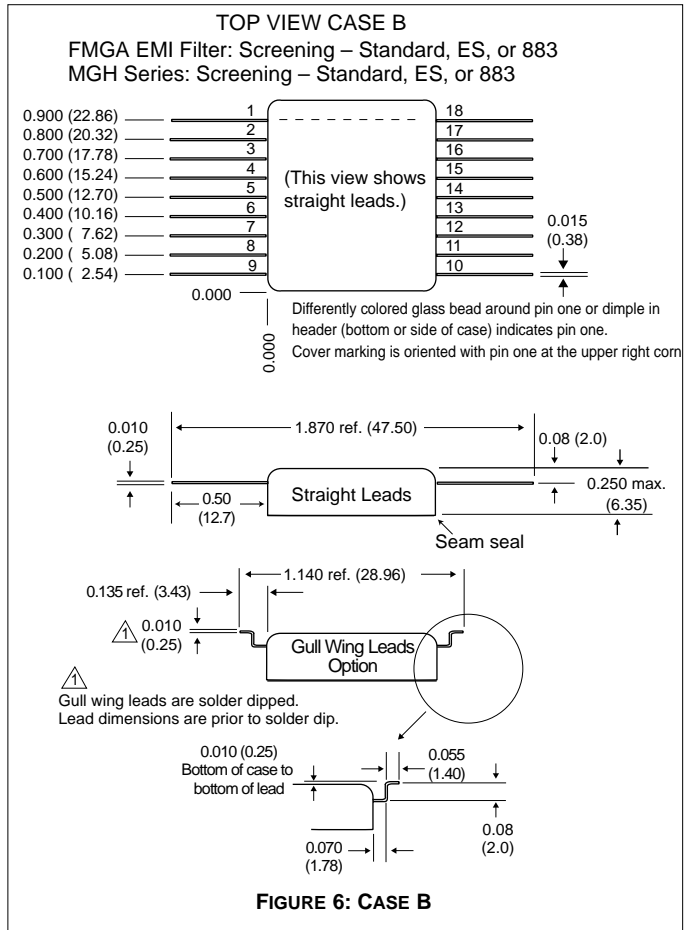
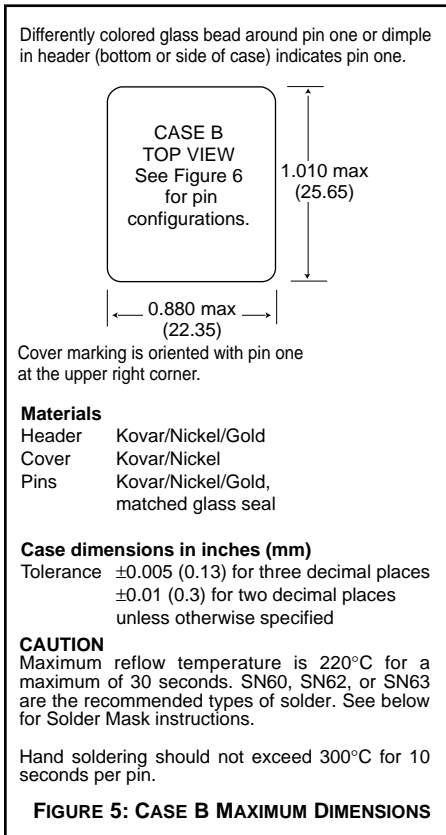

FIGURE 15



Note: Although every effort has been made to render the case drawings at actual size, variations in the printing process may cause some distortion. Please refer to the numerical dimensions for accuracy.

QA SCREENING 125°C PRODUCTS

125°C PRODUCTS

TEST (125°C Products)	STANDARD	/ES	/883 (Class H)*
PRE-CAP INSPECTION Method 2017, 2032	yes	yes	yes
TEMPERATURE CYCLE (10 times) Method 1010, Cond. C, -65°C to 150°C Method 1010, Cond. B, -55°C to 125°C	no no	no yes	yes no
CONSTANT ACCELERATION Method 2001, 3000 g Method 2001, 500 g	no no	no yes	yes no
BURN-IN Method 1015, 160 hours at 125°C 96 hours at 125°C case (typical)	no no	no yes	yes no
FINAL ELECTRICAL TEST MIL-PRF-38534, Group A Subgroups 1 through 6: -55°C, +25°C, +125°C Subgroups 1 and 4: +25°C case	no yes	no yes	yes no
HERMETICITY TESTING Fine Leak, Method 1014, Cond. A Gross Leak, Method 1014, Cond. C Gross Leak, Dip (1 x 10 ⁻³)	no no yes	yes yes no	yes yes no
FINAL VISUAL INSPECTION Method 2009	yes	yes	yes

Test methods are referenced to MIL-STD-883 as determined by MIL-PRF-38534.

*883 products are built with element evaluated components and are 100% tested and guaranteed over the full military temperature range of -55°C to +125°C.

Applies to the following products

MOR Series	MHD Series	MGH Series	FMGA EMI Filter
MFLHP Series	MHV Series	MCH Series	FMSA EMI Filter
MFL Series	MHF+ Series	FM-704A EMI Filter	HUM Modules**
MHP Series	MHF Series**	FMD**/FME EMI Filter	LCM Modules**
MTR Series	MGA Series	FMC EMI Filter	LIM Modules
MQO Series**	MSA Series	FMH EMI Filter	

**MFLHP Series, MQO Series, MHF Series, FMD EMI Filters, Hum Modules, and LCM Modules do not offer '883' screening.