

### Technical Data

STT Series

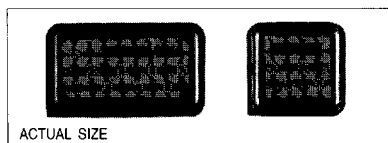
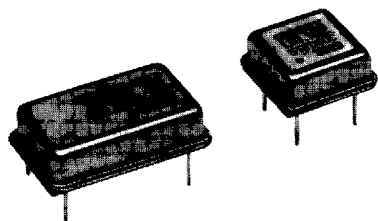

#### Description

A crystal controlled, low-current oscillator providing precise rise and fall times to drive TTL loads and TTL microprocessors like the Intel 486 and Pentium, Motorola 68040, National 32532, AMD 29000, LSI 64901 and MIPS R3000/R4000. The tri-state function enables the output to go high impedance. Available in either a 14 or an 8 pin DIP compatible, resistance welded, all metal case. Pin 7 (or Pin 4) is grounded to case to reduce EMI.

#### Applications & Features

- Ideally suited for clock generation requirements of todays CISC and RISC based systems
- Very broad frequency range 250 kHz to 135 MHz
- High Drive TTL-Compatible (up to 50mA sink and source)
- Tri-State output
- Optional reverse tri-state logic input
- Precise Rise/Fall Times
- Reduced EMI circuitry
- Short circuit protected output
- Also available in plastic, surface mount STA/STT Series Type F, see separate data sheet

<b>Frequency Range:</b>	250 kHz to 135 MHz
<b>Frequency Stability:</b>	±25, ±50 or ±100 ppm over all conditions: calibration tolerance, operating temperature, input voltage change, load change, aging, shock and vibration
<b>Temperature Range:</b>	Operating: 0°C to +70°C Storage: -55°C to +125°C
<b>Supply Voltage:</b>	Operating: +5 VDC ±10% Absolute Maximum: +7 VDC
<b>Supply Current:</b>	up to 60 MHz: 20mA typical, 30mA max @ 25°C 35mA max over operating temperature range 60 MHz to 80 MHz: 35mA typical, 40mA max @ 25°C 50mA max over operating temperature range Above 80 MHz: 55mA typical, 65mA max @ 25°C 75mA max over temperature range
<b>Output Drive:</b>	TTL Symmetry: 50 ±10% @ 1.5V level (50 ±5% available < 50 MHz) Rise & Fall Times: 0.5 to 2.5V, see Part Numbering Guide Logic 0: 0.5V max Logic 1: 2.5V min Output Load: 50mA sink & source
<b>Mechanical:</b>	Shock: MIL-STD-883, Method 2002, Condition B Solderability: MIL-STD-883, Method 2003 Terminal Strength: MIL-STD-883, Method 211, Conditions A and C Vibration: MIL-STD-883, Method 2007, Condition A Solvent Resistance: MIL-STD-202, Method 215 Resistance to Soldering Heat: MIL-STD-202, Method 210, Condition B
<b>Environmental:</b>	Gross Leak Test: MIL-STD-883, Method 1014, Condition C Fine Leak Test: MIL-STD-883, Method 1014, Condition A2 <5 x 10 <sup>-8</sup> ATM cc/sec Thermal Shock: MIL-STD-883, Method 1011, Conditions A Moisture Resistance: MIL-STD-883, Method 1004

### Technical Data

### STT Series

#### Package Details

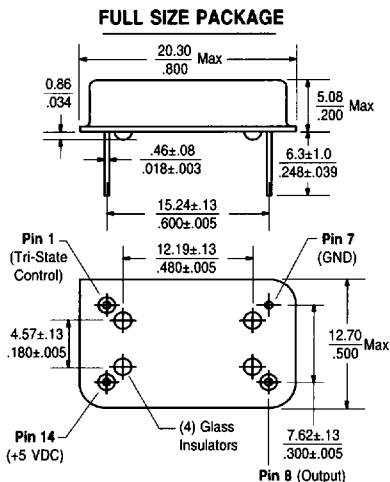

#### Standard Marking Format

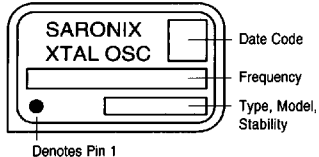

#### HALF SIZE PACKAGE

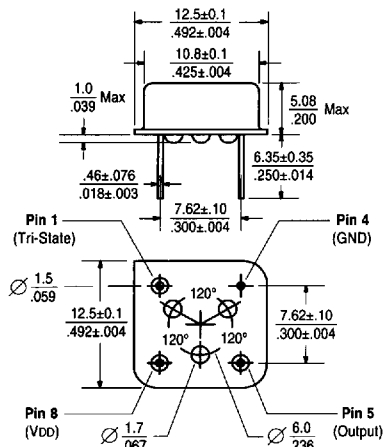

#### Standard Marking Format

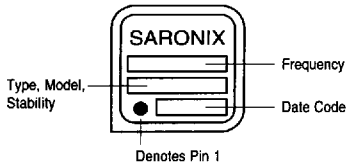

Scale: None (Dimensions in  $\frac{mm}{inches}$ )

#### Part Numbering Guide

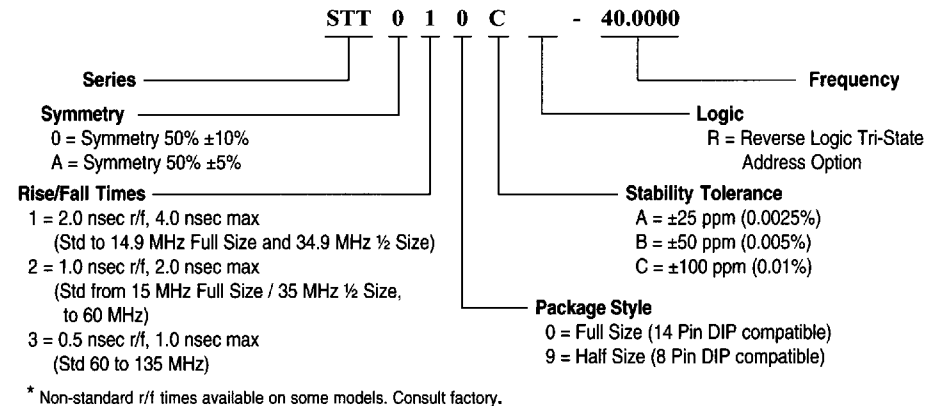

Example PN: STT030C - 100.0000

#### Output Waveform

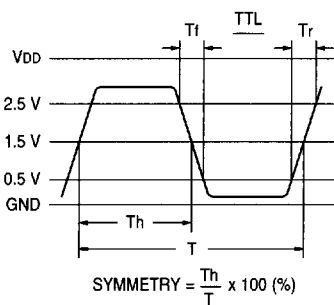

#### Tri-State Logic Table

Pin 1 Input	Output Standard Logic	Output Reverse Logic
Logic "1" or NC	Oscillation	High Impedance
Logic "0" or GND	High Impedance	Oscillation

Required Input Levels on Pin 1:  
Logic "1" = 2.0V min  
Logic "0" = 0.8V max

#### Test Circuit

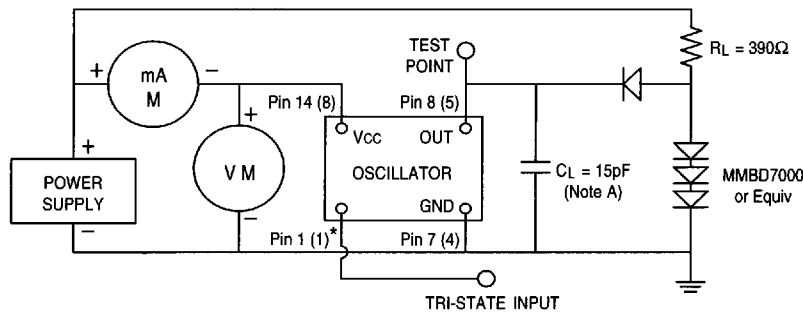

NOTE A: CL includes probe and fixture capacitance

\* ( ) Indicates pin numbers for half-size package

#### TTL TEST CIRCUIT

All specifications are subject to change without notice.

DS-108 REV D March 1995 2.6