

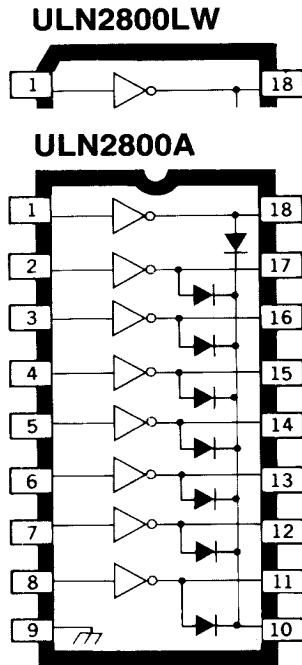

## HIGH-VOLTAGE, HIGH-CURRENT DARLINGTON ARRAYS



Dwg. No. A-10, 322A

### ABSOLUTE MAXIMUM RATINGS

Output Voltage, $V_{CE}$	
(ULN280X*, ULN281XA) .....	50 V
(ULN282X*) .....	95 V
Input Voltage, $V_{IN}$	
(ULN28X2, X3, X4*) .....	30 V
(ULN28X5*) .....	15 V
Continuous Output Current, $I_C$	
(ULN280X*, ULN282X*) .....	500 mA
(ULN281XA) .....	600 mA
Continuous Input Current, $I_{IN}$ .....	25 mA
Power Dissipation, $P_D$	
(one Darlington pair) .....	1.0 W
(total package) .....	See Graph
Operating Temperature	
Range, $T_A$ .....	-20°C to +85°C
Storage Temperature	
Range, $T_S$ .....	-55°C to +150°C

Note that the Series ULN2800A (dual in-line package) and Series ULN2800LW (small outline IC package) are electrically identical and share a common pin number assignment.

Featuring continuous load current ratings to 600 mA for each of the eight drivers, the Series ULN2800A/LW high-voltage, high-current Darlington arrays are ideally suited for interfacing between low-level logic circuitry and multiple peripheral power loads. Typical power loads totaling over 300 W (400 mA x 8, 95 V) can be controlled at an appropriate duty cycle depending on ambient temperature and number of drivers turned ON simultaneously. Typical loads include relays, solenoids, stepping motors, multiplexed LED and incandescent displays, and heaters. All devices feature open collector outputs with integral clamp diodes.

The Series ULN28x1A/LW devices are general-purpose arrays which may be used with external input current limiting, or with most PMOS or CMOS logic directly.

The Series ULN28x2A/LW is intended for use with 14 to 25 V PMOS logic. Each input has a series Zener diode and current limiting resistor. The Zener diode also provides excellent noise immunity for these devices.

The Series ULN28x3A/LW has series input resistors selected for operation directly with 5 V TTL or CMOS. These devices will handle numerous interface needs — particularly those beyond the capabilities of standard logic buffers.

The Series ULN28x4A/LW features series input resistors for operation directly from 6 to 15 V CMOS or PMOS logic outputs.

The Series ULN28x5A/LW is designed for use with standard and Schottky TTL where higher output currents are required and loading of the logic output is not a concern. These devices will sink a minimum of 350 mA when driven from a TTL "totem pole" logic output.

The Series ULN280xA/LW is the standard Darlington array. The outputs are capable of sinking 500 mA and will withstand at least 50 V in the OFF state. Outputs may be paralleled for higher load current capability. The Series ULN281xA devices are similar except that they will sink 600 mA. The Series ULN282xA/LW will withstand 95 V in the OFF state.

These Darlington arrays are furnished in 18-pin dual in-line plastic packages (suffix A) and 18-lead surface-mountable wide-body SOICs (suffix LW). All devices are pinned with outputs opposite inputs to facilitate ease of circuit board layout.

### FEATURES

- TTL, DTL, PMOS, or CMOS Compatible Inputs
- Output Current to 600 mA
- Output Voltage to 95V
- Transient-Protected Outputs
- Dual In-Line Plastic Package or Small-Outline IC Package

x = digit to identify specific device. Characteristic shown applies to family of devices with remaining digits as shown.

# ULN2801A/LW through ULN2825A/LW HIGH-VOLTAGE, HIGH-CURRENT DARLINGTON ARRAYS

## PARTIAL SCHEMATICS

### ULN28X1\* (Each Driver)

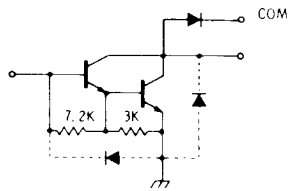

### ULN28X2\* (Each Driver)

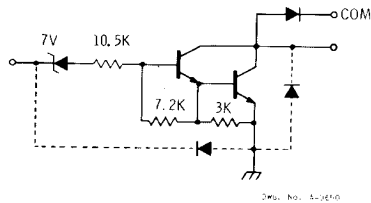

### ULN28X3\* (Each Driver)

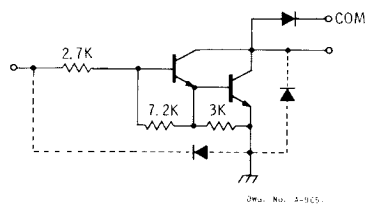

### ULN28X4\* (Each Driver)

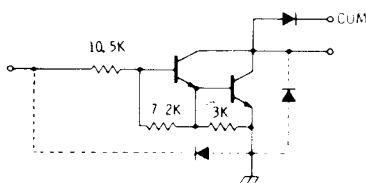

### ULN28X5\* (Each Driver)

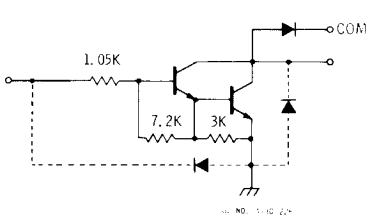

## Device Number Designation

$V_{CE(MAX)}$	5 V	50V	95V
$I_C(MAX)$	500 mA	600 mA	500 mA
Logic	Part Number		
General Purpose PMOS, CMOS	ULN2801*	ULN2811A	ULN2821*
14-25 V PMOS	ULN2802*	ULN2812A	ULN2822*
5 V TTL, CMOS	ULN2803*	ULN2813A	ULN2823*
6-15 V CMOS, PMOS	ULN2804*	ULN2814A	ULN2824*
High-Output TTL	ULN2805*	ULN2815A	ULN2825*

## ALLOWABLE AVERAGE PACKAGE POWER DISSIPATION

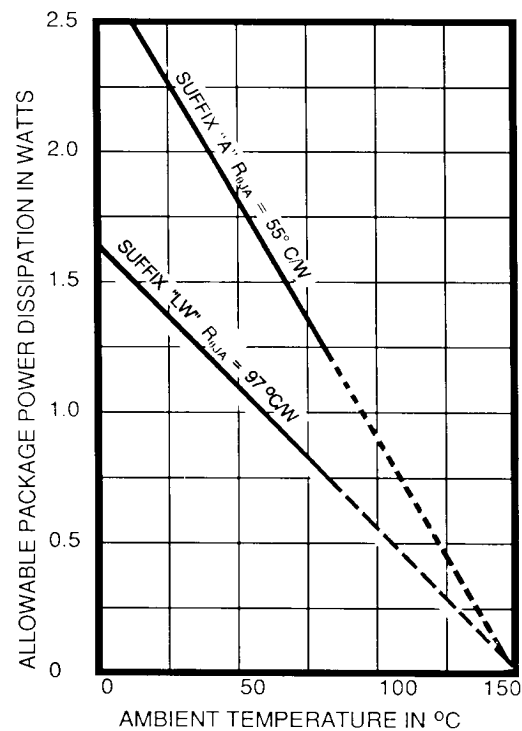

\*Complete part number includes a final letter to indicate package

(A = DIP, LW = Wide-Body SOIC)

X = Digit to identify specific device. Specification shown applies to family of devices with remaining digits as shown.

# SPRAGUE

115 Northeast Cutoff, Box 15036  
Worcester, Massachusetts 01615-0036 (508) 853-5000

Copyright © 1988 Sprague Electric Company

# ULN2801A/LW through ULN2825A/LW HIGH-VOLTAGE, HIGH-CURRENT DARLINGTON ARRAYS

## TEST FIGURES

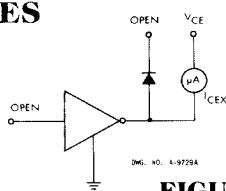

FIGURE 1A

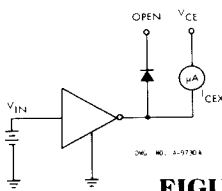

FIGURE 1B

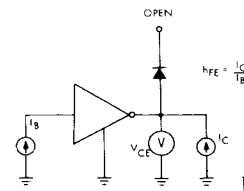

FIGURE 2

## SERIES ULN2800A/LW ELECTRICAL CHARACTERISTICS AT 25°C (unless otherwise noted)

Characteristic	Symbol	Test Fig.	Applicable Devices	Test Conditions	Limits			Units
					Min.	Typ.	Max.	
Output Leakage Current	$I_{CEX}$	1A	All	$V_{CE} = 50\text{ V}, T_A = 25^\circ\text{C}$	—	—	50	$\mu\text{A}$
				$V_{CE} = 50\text{ V}, T_A = 70^\circ\text{C}$	—	—	100	$\mu\text{A}$
		1B	ULN2802*	$V_{CE} = 50\text{ V}, T_A = 70^\circ\text{C}, V_{IN} = 6.0\text{ V}$	—	—	500	$\mu\text{A}$
			ULN2804*	$V_{CE} = 50\text{ V}, T_A = 70^\circ\text{C}, V_{IN} = 1.0\text{ V}$	—	—	500	$\mu\text{A}$
Collector-Emitter Saturation Voltage	$V_{CE(SAT)}$	2	All	$I_C = 100\text{ mA}, I_B = 250\text{ }\mu\text{A}$	—	0.9	1.1	V
				$I_C = 200\text{ mA}, I_B = 350\text{ }\mu\text{A}$	—	1.1	1.3	V
				$I_C = 350\text{ mA}, I_B = 500\text{ }\mu\text{A}$	—	1.3	1.6	V
Input Current	$I_{IN(ON)}$	3	ULN2802*	$V_{IN} = 17\text{ V}$	—	0.82	1.25	mA
			ULN2803*	$V_{IN} = 3.85\text{ V}$	—	0.93	1.35	mA
			ULN2804*	$V_{IN} = 5.0\text{ V}$	—	0.35	0.5	mA
				$V_{IN} = 12\text{ V}$	—	1.0	1.45	mA
	ULN2805*	$V_{IN} = 3.0\text{ V}$	—	1.5	2.4	mA		
	$I_{IN(OFF)}$	4	All	$I_C = 500\text{ }\mu\text{A}, T_A = 70^\circ\text{C}$	50	65	—	$\mu\text{A}$
Input Voltage	$V_{IN(ON)}$	5	ULN2802*	$V_{CE} = 2.0\text{ V}, I_C = 300\text{ mA}$	—	—	13	V
			ULN2803*	$V_{CE} = 2.0\text{ V}, I_C = 200\text{ mA}$	—	—	2.4	V
				$V_{CE} = 2.0\text{ V}, I_C = 250\text{ mA}$	—	—	2.7	V
				$V_{CE} = 2.0\text{ V}, I_C = 300\text{ mA}$	—	—	3.0	V
				ULN2804*	$V_{CE} = 2.0\text{ V}, I_C = 125\text{ mA}$	—	—	5.0
			$V_{CE} = 2.0\text{ V}, I_C = 200\text{ mA}$		—	—	6.0	V
			$V_{CE} = 2.0\text{ V}, I_C = 275\text{ mA}$		—	—	7.0	V
			ULN2805*	$V_{CE} = 2.0\text{ V}, I_C = 350\text{ mA}$	—	—	8.0	V
				$V_{CE} = 2.0\text{ V}, I_C = 350\text{ mA}$	—	—	2.4	V
D-C Forward Current Transfer Ratio	$h_{FE}$	2	ULN2801*	$V_{CE} = 2.0\text{ V}, I_C = 350\text{ mA}$	1000	—	—	
Input Capacitance	$C_{IN}$	—	All		—	15	25	pF
Turn-On Delay	$t_{ON}$	8	All	$0.5 E_{in}$ to $0.5 E_{out}$	—	0.25	1.0	$\mu\text{s}$
Turn-Off Delay	$t_{OFF}$	8	All	$0.5 E_{in}$ to $0.5 E_{out}$	—	0.25	1.0	$\mu\text{s}$
Clamp Diode Leakage Current	$I_R$	6	All	$V_R = 50\text{ V}, T_A = 25^\circ\text{C}$	—	—	50	$\mu\text{A}$
				$V_R = 50\text{ V}, T_A = 70^\circ\text{C}$	—	—	100	$\mu\text{A}$
Clamp Diode Forward Voltage	$V_F$	7	All	$I_F = 350\text{ mA}$	—	1.7	2.0	V

\*Complete part number includes suffix to identify package style: A = DIP, LW = Wide-Body SOIC.

SEMICONDUCTOR GROUP

# ULN2801A/LW through ULN2825A/LW HIGH-VOLTAGE, HIGH-CURRENT DARLINGTON ARRAYS

## TEST FIGURES

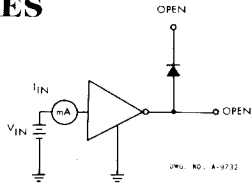

FIGURE 3

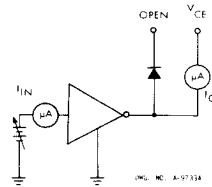

FIGURE 4

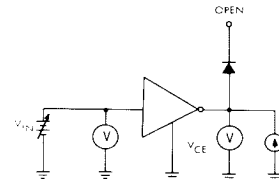

FIGURE 5

## SERIES ULN2810A

### ELECTRICAL CHARACTERISTICS AT 25°C (unless otherwise noted)

Characteristic	Symbol	Test Fig.	Applicable Devices	Test Conditions	Limits			Units
					Min.	Typ.	Max.	
Output Leakage Current	$I_{CEX}$	1A	All	$V_{CE} = 50\text{ V}, T_A = 25^\circ\text{C}$	—	—	50	$\mu\text{A}$
				$V_{CE} = 50\text{ V}, T_A = 70^\circ\text{C}$	—	—	100	$\mu\text{A}$
		1B	ULN2812A	$V_{CE} = 50\text{ V}, T_A = 70^\circ\text{C}, V_{IN} = 6.0\text{ V}$	—	—	500	$\mu\text{A}$
			ULN2814A	$V_{CE} = 50\text{ V}, T_A = 70^\circ\text{C}, V_{IN} = 1.0\text{ V}$	—	—	500	$\mu\text{A}$
Collector-Emitter Saturation Voltage	$V_{CE(SAT)}$	2	All	$I_C = 200\text{ mA}, I_B = 350\ \mu\text{A}$	—	1.1	1.3	V
				$I_C = 350\text{ mA}, I_B = 500\ \mu\text{A}$	—	1.3	1.6	V
				$I_C = 500\text{ mA}, I_B = 600\ \mu\text{A}$	—	1.7	1.9	V
Input Current	$I_{IN(ON)}$	3	ULN2812A	$V_{IN} = 17\text{ V}$	—	0.82	1.25	mA
			ULN2813A	$V_{IN} = 3.85\text{ V}$	—	0.93	1.35	mA
			ULN2814A	$V_{IN} = 5.0\text{ V}$	—	0.35	0.5	mA
				$V_{IN} = 12\text{ V}$	—	1.0	1.45	mA
	ULN2815A	$V_{IN} = 3.0\text{ V}$	—	1.5	2.4	mA		
	$I_{IN(OFF)}$	4	All	$I_C = 500\ \mu\text{A}, T_A = 70^\circ\text{C}$	50	65	—	$\mu\text{A}$
Input Voltage	$V_{IN(ON)}$	5	ULN2812A	$V_{CE} = 2.0\text{ V}, I_C = 500\text{ mA}$	—	—	17	V
			ULN2813A	$V_{CE} = 2.0\text{ V}, I_C = 250\text{ mA}$	—	—	2.7	V
				$V_{CE} = 2.0\text{ V}, I_C = 300\text{ mA}$	—	—	3.0	V
				$V_{CE} = 2.0\text{ V}, I_C = 500\text{ mA}$	—	—	3.5	V
			ULN2814A	$V_{CE} = 2.0\text{ V}, I_C = 275\text{ mA}$	—	—	7.0	V
				$V_{CE} = 2.0\text{ V}, I_C = 350\text{ mA}$	—	—	8.0	V
				$V_{CE} = 2.0\text{ V}, I_C = 500\text{ mA}$	—	—	9.5	V
ULN2815A	$V_{CE} = 2.0\text{ V}, I_C = 500\text{ mA}$	—	—	2.6	V			
D-C Forward Current Transfer Ratio	$h_{FE}$	2	ULN2811A	$V_{CE} = 2.0\text{ V}, I_C = 350\text{ mA}$	1000	—	—	
				$V_{CE} = 2.0\text{ V}, I_C = 500\text{ mA}$	900	—	—	
Input Capacitance	$C_{IN}$	—	All		—	15	25	pF
Turn-On Delay	$t_{ON}$	8	All	$0.5 E_{in}$ to $0.5 E_{out}$	—	0.25	1.0	$\mu\text{s}$
Turn-Off Delay	$t_{OFF}$	8	All	$0.5 E_{in}$ to $0.5 E_{out}$	—	0.25	1.0	$\mu\text{s}$
Clamp Diode Leakage Current	$I_R$	6	All	$V_R = 50\text{ V}, T_A = 25^\circ\text{C}$	—	—	50	$\mu\text{A}$
				$V_R = 50\text{ V}, T_A = 70^\circ\text{C}$	—	—	100	$\mu\text{A}$
Clamp Diode Forward Voltage	$V_F$	7	All	$I_F = 350\text{ mA}$	—	1.7	2.0	V
				$I_F = 500\text{ mA}$	—	2.1	2.5	V

# SPRAGUE

115 Northeast Cutoff, Box 15036  
Worcester, Massachusetts 01615-0036 (508) 853-5000

# ULN2801A/LW through ULN2825A/LW HIGH-VOLTAGE, HIGH-CURRENT DARLINGTON ARRAYS

## TEST FIGURES

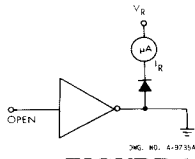

FIGURE 6

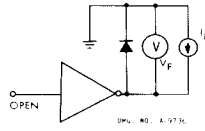

FIGURE 7

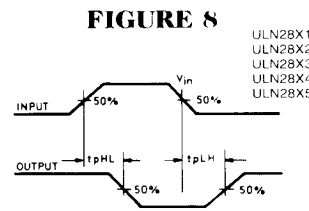
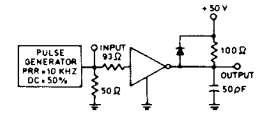

FIGURE 8

ULN28X1\*  
ULN28X2\*  
ULN28X3\*  
ULN28X4\*  
ULN28X5\*

V<sub>in</sub>  
3.5V  
13V  
3.5V  
12V  
3.5V



Complete part number includes a final letter to indicate package.  
Digit to identify specific device. Specification shown applies to family of devices with remaining digits as shown.

## SERIES ULN2820A/LW ELECTRICAL CHARACTERISTICS AT 25°C (unless otherwise noted)

Characteristic	Symbol	Test Fig.	Applicable Devices	Test Conditions	Limits			Units
					Min.	Typ.	Max.	
Output Leakage Current	I <sub>CEX</sub>	1A	All	V <sub>CE</sub> = 95 V, T <sub>A</sub> = 25°C	—	—	50	μA
				V <sub>CE</sub> = 95 V, T <sub>A</sub> = 70°C	—	—	100	μA
		1B	ULN2822*	V <sub>CE</sub> = 95 V, T <sub>A</sub> = 70°C, V <sub>IN</sub> = 6.0 V	—	—	500	μA
				ULN2824*	V <sub>CE</sub> = 95 V, T <sub>A</sub> = 70°C, V <sub>IN</sub> = 1.0 V	—	—	500
Collector-Emitter Saturation Voltage	V <sub>CE(SAT)</sub>	2	All	I <sub>C</sub> = 100 mA, I <sub>B</sub> = 250 μA	—	0.9	1.1	V
				I <sub>C</sub> = 200 mA, I <sub>B</sub> = 350 μA	—	1.1	1.3	V
				I <sub>C</sub> = 350 mA, I <sub>B</sub> = 500 μA	—	1.3	1.6	V
Input Current	I <sub>IN(ON)</sub>	3	ULN2822*	V <sub>IN</sub> = 17 V	—	0.82	1.25	mA
			ULN2823*	V <sub>IN</sub> = 3.85 V	—	0.93	1.35	mA
			ULN2824*	V <sub>IN</sub> = 5.0 V	—	0.35	0.5	mA
				V <sub>IN</sub> = 12 V	—	1.0	1.45	mA
			ULN2825*	V <sub>IN</sub> = 3.0 V	—	1.5	2.4	mA
	I <sub>IN(OFF)</sub>	4	All	I <sub>C</sub> = 500 μA, T <sub>A</sub> = 70°C	50	65	—	μA
Input Voltage	V <sub>IN(ON)</sub>	5	ULN2822*	V <sub>CE</sub> = 2.0 V, I <sub>C</sub> = 300 mA	—	—	13	V
			ULN2823*	V <sub>CE</sub> = 2.0 V, I <sub>C</sub> = 200 mA	—	—	2.4	V
				V <sub>CE</sub> = 2.0 V, I <sub>C</sub> = 250 mA	—	—	2.7	V
				V <sub>CE</sub> = 2.0 V, I <sub>C</sub> = 300 mA	—	—	3.0	V
			ULN2824*	V <sub>CE</sub> = 2.0 V, I <sub>C</sub> = 125 mA	—	—	5.0	V
				V <sub>CE</sub> = 2.0 V, I <sub>C</sub> = 200 mA	—	—	6.0	V
				V <sub>CE</sub> = 2.0 V, I <sub>C</sub> = 275 mA	—	—	7.0	V
				V <sub>CE</sub> = 2.0 V, I <sub>C</sub> = 350 mA	—	—	8.0	V
			ULN2825*	V <sub>CE</sub> = 2.0 V, I <sub>C</sub> = 350 mA	—	—	2.4	V
D-C Forward Current Transfer Ratio	h <sub>FE</sub>	2	ULN2821*	V <sub>CE</sub> = 2.0 V, I <sub>C</sub> = 350 mA	1000	—	—	
Input Capacitance	C <sub>IN</sub>	—	All		—	15	25	pF
Turn-On Delay	t <sub>ON</sub>	8	All	0.5 E <sub>in</sub> to 0.5 E <sub>out</sub>	—	0.25	1.0	μs
Turn-Off Delay	t <sub>OFF</sub>	8	All	0.5 E <sub>in</sub> to 0.5 E <sub>out</sub>	—	0.25	1.0	μs
Clamp Diode Leakage Current	I <sub>R</sub>	6	All	V <sub>R</sub> = 95 V, T <sub>A</sub> = 25°C	—	—	50	μA
				V <sub>R</sub> = 95 V, T <sub>A</sub> = 70°C	—	—	100	μA
Clamp Diode Forward Voltage	V <sub>F</sub>	7	All	I <sub>F</sub> = 350 mA	—	1.7	2.0	V

\*Complete part number includes suffix to identify package style: A = DIP, LW = Wide-Body SOIC.

SEMICONDUCTOR GROUP

# ULN2801A/LW through ULN2825A/LW HIGH-VOLTAGE, HIGH-CURRENT DARLINGTON ARRAYS

**COLLECTOR CURRENT AS A FUNCTION OF SATURATION VOLTAGE**

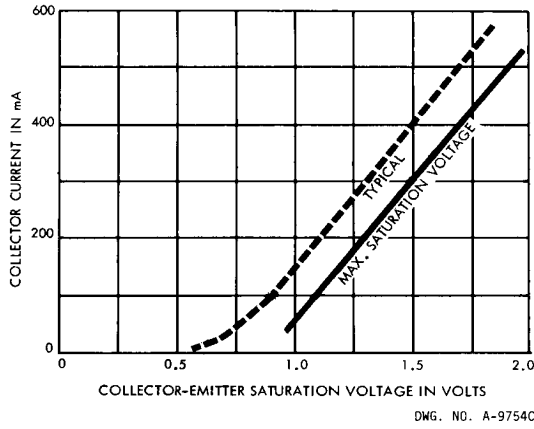

**PEAK COLLECTOR CURRENT AS A FUNCTION OF DUTY CYCLE  
(Dual In-line Packaged Devices)**

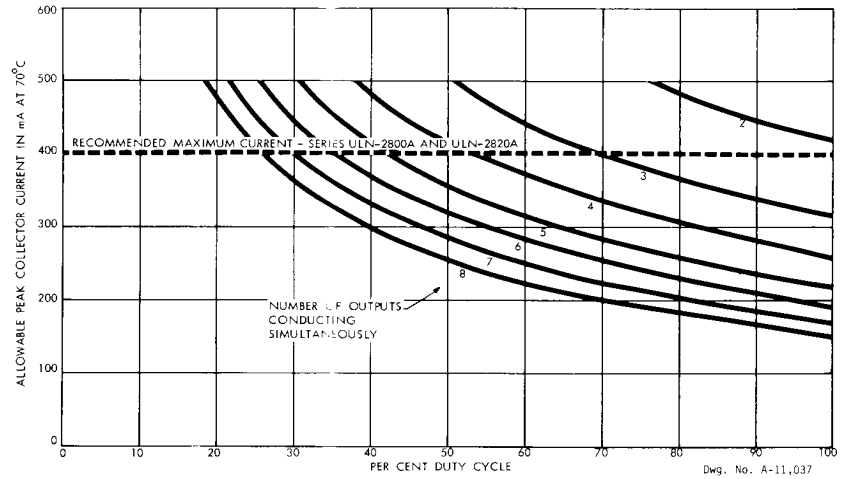

**COLLECTOR CURRENT AS A FUNCTION OF INPUT CURRENT**

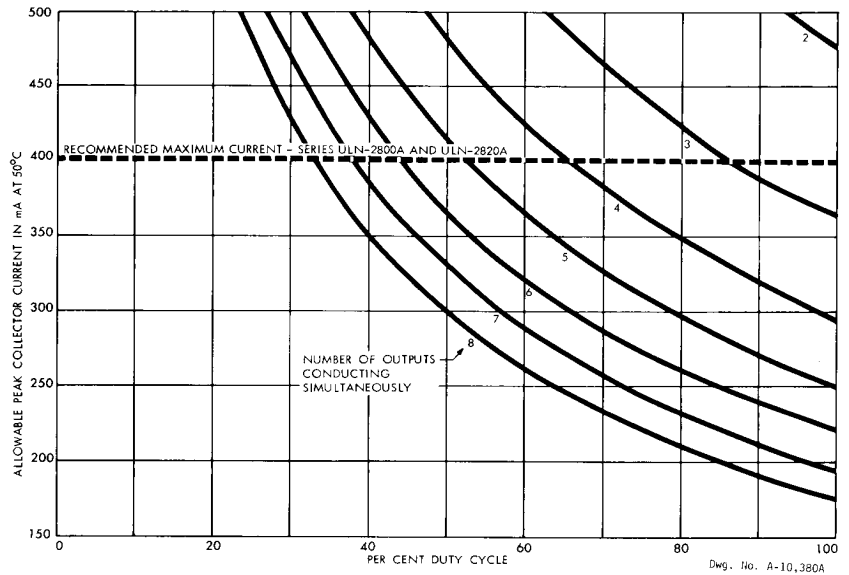
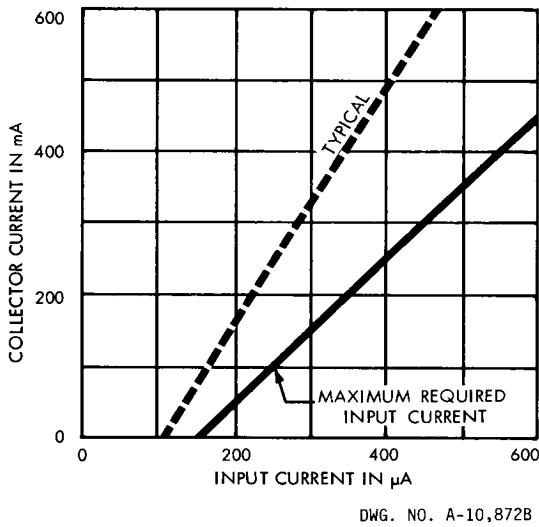

**SPRAGUE**

115 Northeast Cutoff, Box 15036  
Worcester, Massachusetts 01615-0036 (508) 853-5000

# ULN2801A/LW through ULN2825A/LW HIGH-VOLTAGE, HIGH-CURRENT DARLINGTON ARRAYS

**PEAK COLLECTOR CURRENT AS A FUNCTION OF DUTY CYCLE (Small Outline Packaged Devices)**

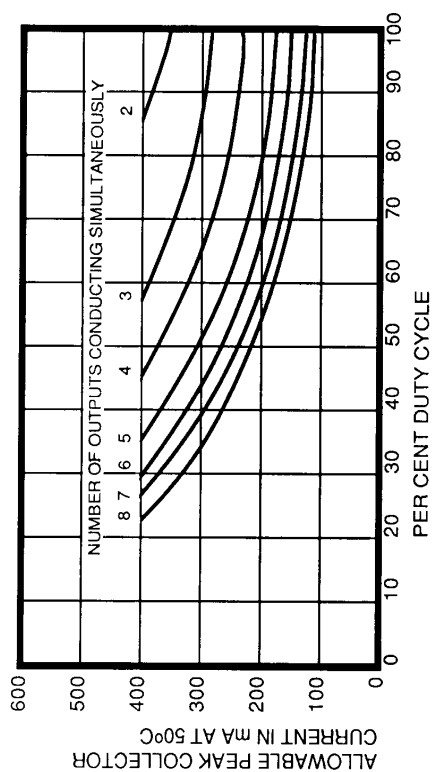
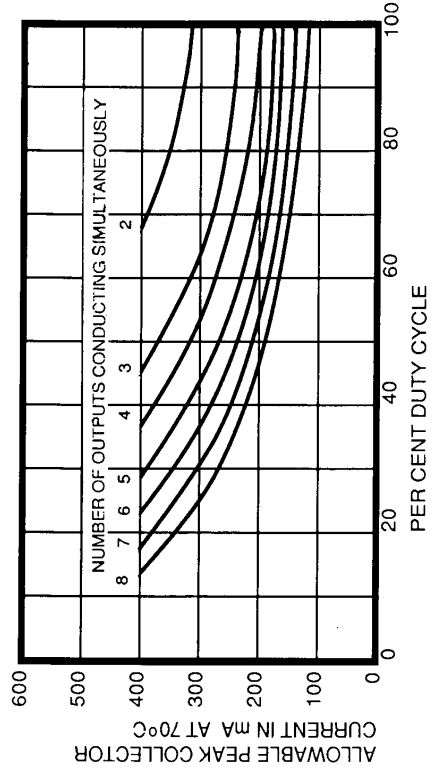

**INPUT CURRENT AS A FUNCTION OF INPUT VOLTAGE**

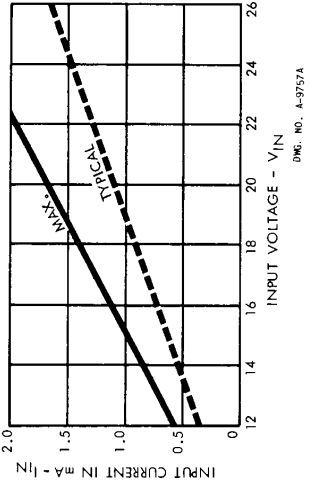

**SERIES ULN2802A/LW**

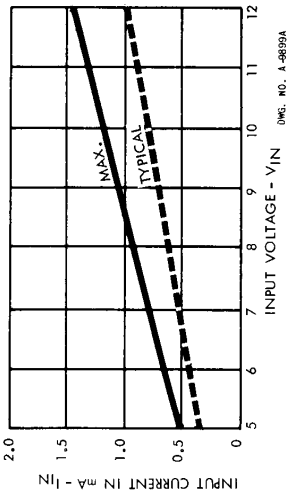

**SERIES ULN2804A/LW**

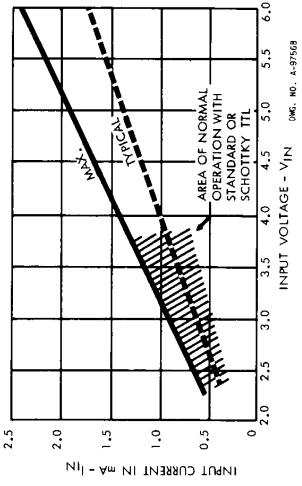

**SERIES ULN2803A/LW**

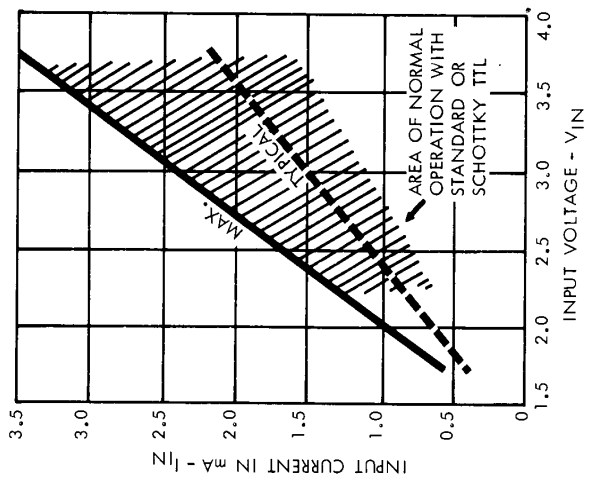

**SERIES ULN2805A/LW**

