

PLEASE CHECK WWW.MOLEX.COM FOR LATEST PART INFORMATION

Part Number: [0850423524](#)
Status: **Active**
Overview: [din_41612](#)
Description: 2.54mm (.100") Pitch DIN 41612 Receptacle, Style C, 64 Circuits

Documents:

[3D Model](#) [RoHS Certificate of Compliance \(PDF\)](#)
[Drawing \(PDF\)](#)

Agency Certification

CSA LR19980
 UL E29179

General

Product Family Backplane Connectors
 Series [85042](#)
 Application Daughtercard
 Component Type PCB Receptacle
 Overview [din_41612](#)
 Product Name IEC 603-2/DIN 41612
 Style C

Physical

Circuits (Loaded) 64
 Circuits (maximum) 96
 Circuits Detail Rows A & C
 Durability (mating cycles max) 400
 First Mate / Last Break No
 Flammability 94V-0
 Guide to Mating Part No
 Keying to Mating Part Yes
 Number of Columns 32
 Number of Pairs Open Pin Field
 Number of Rows 3
 Orientation Vertical
 PC Tail Length (in) 0.114 In
 PC Tail Length (mm) 2.90 mm
 PCB Locator No
 PCB Retention Yes
 Packaging Type Tray
 Pitch - Mating Interface (in) 0.100 In
 Pitch - Mating Interface (mm) 2.54 mm
 Pitch - Term. Interface (in) 0.100 In
 Pitch - Term. Interface (mm) 2.54 mm
 Polarized to PCB Yes
 Stackable No
 Surface Mount Compatible (SMC) No
 Temperature Range - Operating -55°C to +125°C

Electrical

Current - Maximum per Contact 2.5A
 Data Rate 622.0 Mbps
 Real Signals (per 25mm) 29
 Shielded No
 Voltage - Maximum 250V AC (RMS)

Material Info

EU RoHS

**ELV and RoHS
Compliant**

REACH SVHC

Not Reviewed

Halogen-Free

Status

Not Reviewed

China RoHS



**Need more information on product
environmental compliance?**

Email productcompliance@molex.com
 For a multiple part number RoHS Certificate of
 Compliance, [click here](#)

Please visit the [Contact Us](#) section for any
 non-product compliance questions.

Search Parts in this Series

[85042Series](#)

Mates With

DIN 41612 Headers [85003](#) , [85013](#)

Reference - Drawing Numbers

Sales Drawing

SDA-85042-0001, SDA-85042-3524

This document was generated on 05/17/2010

PLEASE CHECK WWW.MOLEX.COM FOR LATEST PART INFORMATION

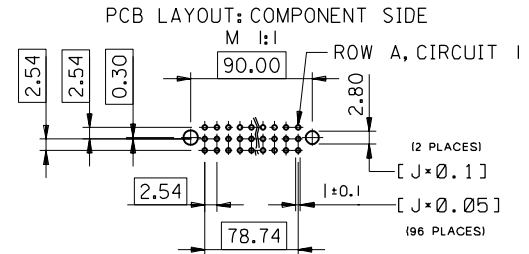
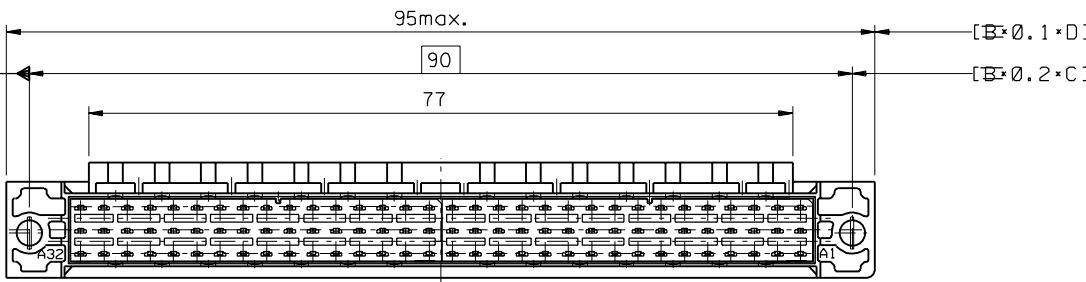

l) tails to fit in PC-board layout

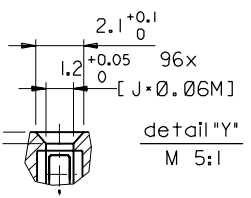
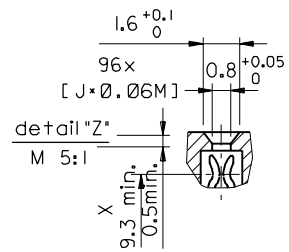
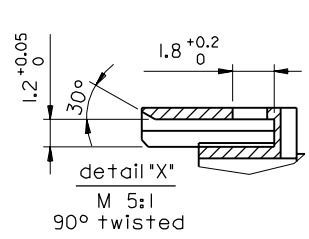
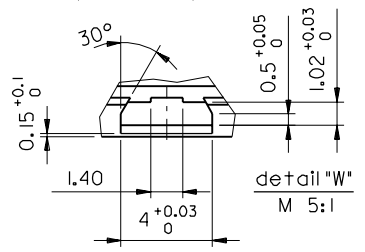
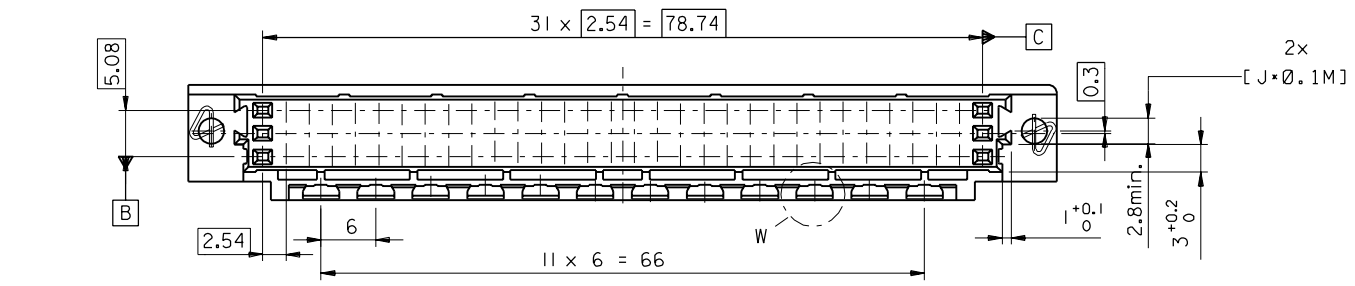
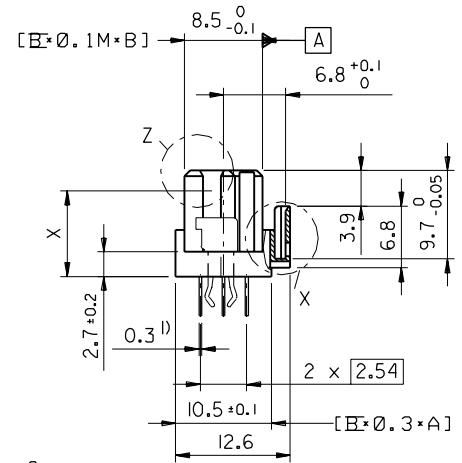
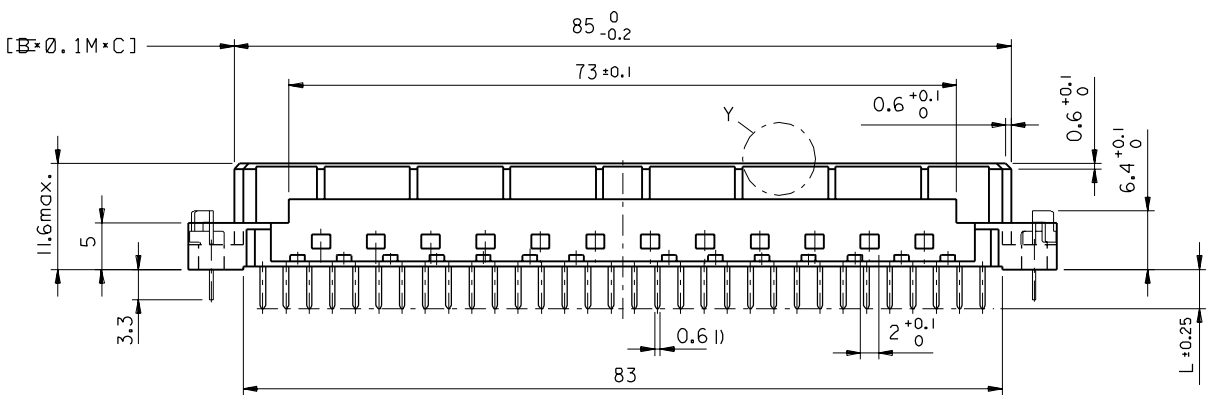

FIRST ANGLE PROJECTION

REVISE ONLY ON CAD SYSTEM

ECN MG1998-2583	Schraube, Lochbild	97-09-17 KN
B	LTR	REVISIONS
FOR PREVIOUS REVISIONS SEE MRI LIST		
UNLESS OTHERWISE SPECIFIED TOLERANCES: ANGULAR ± 2°		
	INCH	METRIC
3 PLACE	±	±
2 PLACE	±	±
1 PLACE	±	±
DRAFT WHERE APPLICABLE MUST REMAIN WITHIN DIMENSIONS		
DESIGN DIMENSION	<input checked="" type="checkbox"/> MM	
	<input type="checkbox"/> IN.	
EQUIVALENT DIMENSION	<input type="checkbox"/> MM	
	<input type="checkbox"/> IN.	
IF TWO DIMENSIONS ARE SHOWN THE UPPER IS THE DESIGN DIMENSION, LOWER IS SECONDARY		

DRWG BY	SIGN	KN
CHK'D BY	SIGN	Ca
APP'D BY	SIGN	JB
SCALE		2:1

CAD/CAM PROJECT NAME	85042000	812
THIS DRAWING CONTAINS INFORMATION THAT IS PROPRIETARY TO MOLEX INC. & SHOULD NOT BE USED WITHOUT WRITTEN PERMISSION		
TITLE		
96 pos. female connector		
DIN 41612 style C, + clip		
with coding, dimensions		
MOLEX MOLEX EUROPE		SHEET NO. DATE
		2 of 2 96/04/30
PART NO.	DWG NO.	SIZE
SDA-85042-0001		B

