

MINIATURE RELAY

2-CONTACT 1A (FOR SWITCHING SIGNALS)

FTR-B3 SERIES

RoHS compliant

■ FEATURES

- These are flat type ultra miniature (SMT), 5.2 ± 0.2 mm height (through hole) relays for telecommunication and data networking equipments, made of high heat resistant material, which can support IRS and VPS methods.
- Ultra slim and light weight with a 5.25 ± 0.2 mm height and approximately 0.8 g weight, and an 87mm^2 mounting area. Most suitable for decreasing size and weight, space saving and high density packaging of equipment.
- Contact spring has superb high frequency characteristics.
- High insulation design conforming to the Bellcore, FCC standard, with a minimum of 1.6 mm between coil and contacts insulation distance, an AC 1.5kV coil contact withstand voltage, and a 2.5kV coil-contact withstand surge voltage.
- High efficiency polar electromagnet structure implements a 140mW low coil power consumption. A power saving latch type is also available.
- Gold-plated silver alloy bifurcated contacts having high contact reliability.
- UL, CSA recognized. Confirms to IEC 60950, UL1950, EN60950. Spacing & high breakdown voltage (Basic insulation, 150 working volts, pollution degree 2).
- RoHS compliant since date code: 0431B8
Please see page 10 for more information

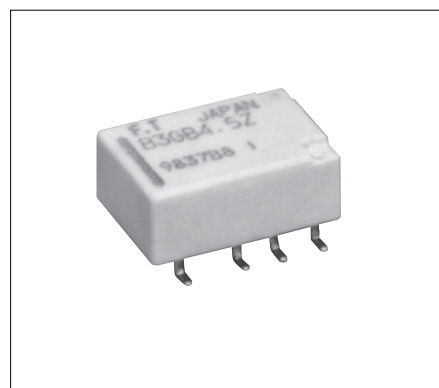

FTR-B3 Series

■ ORDERING INFORMATION

[Example] FTR-B3 G B 012 Z -B 10
 (a) (b) (c) (d) (e) (f) (g)

(a)	Series Name	FTR-B3 Series
(b)	Terminal type	C: through hole G: surface mount S: mounting area, reduced SMT
(c)	Operation function	A: standard type B: latching type (1 coil)
(d)	Rated voltage of coil	1.5: 1.5VDC 4.5: 4.5VDC 003: 3VDC 012: 12VDC 024: 24VDC
(e)	Contact material	Z: gold overlay silver alloy
(f)	Relay enclosing direction*	B: standard enclosing direction
(g)	Number of relays per reel*	10: 1,000 (standard)

Remarks: Actual marking on relay would not carry code FTR and be as below:

Ordering code Actual marking
 FTR-B3GA012Z-B10 → B3GA012Z

Note: *: - Only surface mount types (G and S) are applicable
 - All relays are packaged in tubes unless P/N ends with -B10

FTR-B3 Series

■ SAFETY STANDARD AND FILE NUMBERS

UL508, 1950 (File No. E63615)

C22.2 No. 14, No. 950 (File No. LR40304)

Please request when the approval markings are required on the cover.

Nominal voltage	Contact rating		
1.5 to 12 VDC	0.5 A	125 VAC	resistive
	1 A	30 VDC	
	0.3 A	110 VDC	

■ COIL DATA CHART

Standard type

MODEL	Rated coil voltage	Coil resistance (±10%)	Operating voltage	Release voltage*	Rated power consumption
FTR-B3()A1.5Z	1.5VDC	16.1 Ω	+1.13V	+0.15V	140mW
FTR-B3()A003Z	3VDC	64.3 Ω	+2.25V	+0.3V	140mW
FTR-B3()A4.5Z	4.5VDC	145 Ω	+3.38V	+0.45V	140mW
FTR-B3()A012Z	12VDC	1,028 Ω	+9.0V	+1.2V	140mW
FTR-B3()A024Z	24VDC	2,504 Ω	+18.0V	+2.4V	230mW

* Pulse driven

Note: All values in the table are measured at 20°C.

Latching type (1 coil)

	Rated coil voltage	Coil resistance (±10%)	Set voltage	Release voltage*	Rated power consumption
FTR-B3 ()B1.5Z	1.5VDC	22.5 Ω	+1.13V	-1.13V	100mW
FTR-B3 ()B003Z	3VDC	90 Ω	+2.25V	-2.25V	100mW
FTR-B3 ()B4.5Z	4.5VDC	203 Ω	+3.38V	-3.38V	100mW
FTR-B3 ()B012Z	12VDC	1,440 Ω	+9.0V	-9.0V	100mW
FTR-B3 ()B024Z	24VDC	4,800 Ω	+18.0V	-18.0V	120mW

* Pulse driven

Note: All values in the table are measured at 20°C.

FTR-B3 Series

■ SPECIFICATIONS

Item		Standard Type	Latching Type
		FTR-B3 () A	FTR-B3 () B
Contact	Arrangement	2Form C	
	Contact material	Gold overlay silver alloy	
	Contact type	Bifurcated contacts (cross-bar)	
	Contact resistance (initial value)	75mΩ , maximum at 6VDC 1A	
	Contact rating	30VDC 1A, 125VAC 0.3A (resistive)	
	Maximum carrying/switching current	1A	
	Maximum switching power	62.5 VA / 30W	
	Maximum switching voltage	250 VAC, 220 VDC	
	Minimum switching load *1	10mVDC, 0.01mA*1	
	Capacitance	Approximately 0.4pF (between open contacts) Approximately 0.5pF (adjacent contacts) Approximately 1.0pF *(between coil and contacts)	
Coil	Nominal power (at 20° C)	140mW	100mW
	Operate power (at 20° C)	80mW	57mW
	Operating temperature (no frost)	-40° C to +85° C	
Time Value	Operate (at nominal voltage, without bounce)	3ms maximum	
	Release (at nominal voltage, without bounce)	3ms maximum	
Insulation	Resistance (at 500VDC)		Minimum 1,000 MΩ
	Dielectric Strength	between open contacts	1,000 VAC 1 minute
		between adjacent contacts	1,000 VAC 1 minute
		between coil and contacts	1,500 VAC 1 minute
	Surge Strength	between open contacts	1,500V (at 10 x 160μs) [FCC Part 68]
		between adjacent contacts	1,500V (at 10 x 160μs) [FCC Part 68]
between coil and contacts		1,500V (at 10 x 160μs) [FCC Part 68] 2,500V (at 2 x 10μs) [Bellcore]	

*1 Minimum switching loads mentioned above are reference values. Please perform the confirmation test with the actual load before production since reference values may vary according to switching frequencies, environmental conditions and expected reliability levels.

continued

FTR-B3 Series

■ SPECIFICATIONS

continued

Item		Standard Type	Latching Type
		FTR-B3 () A	FTR-B3 () B
Life	Mechanical	50 x 10 ⁶ operations min. (at 3Hz)	20 x 10 ⁶ operations min. (at 3Hz)
	Electrical (resistive load)	100 x 10 ³ operations min. at 1A 30VDC (at 0.5Hz) 100 x 10 ³ operations min. at 0.3A 125VDC (at 0.5Hz)	
Other	Vibration resistance	Malfunction	10 to 55 Hz at double amplitude of 3.3mm
		Endurance	10 to 55 Hz at double amplitude of 5mm
	Shock resistance	Malfunction	Min. 750 m/s ²
		Endurance	Min. 1000 m/s ²
	Weight	Approximately 0.8g	

■ CHARACTERISTIC DATA

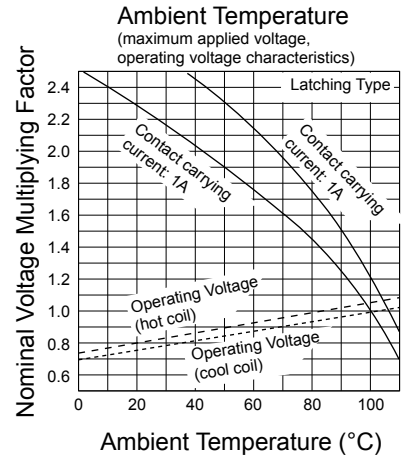
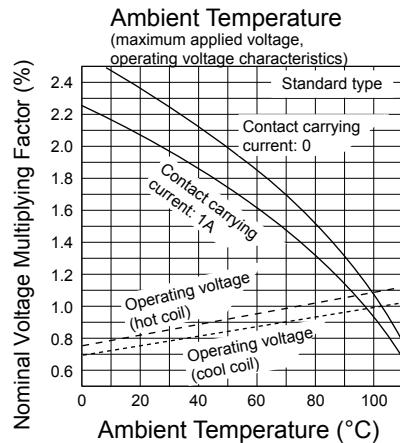
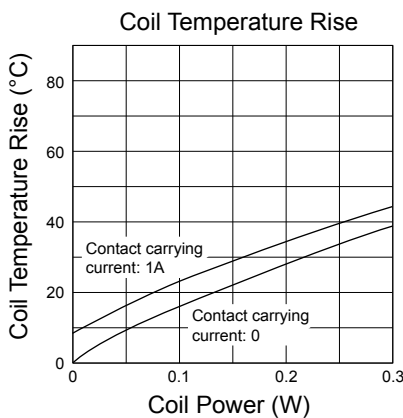
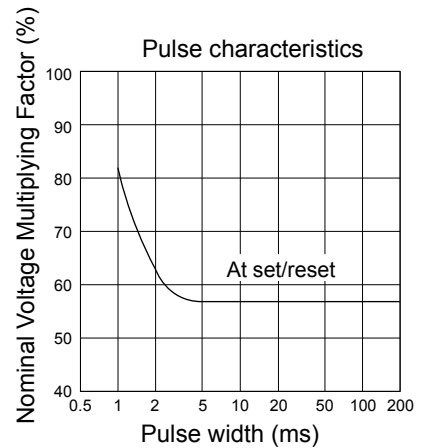
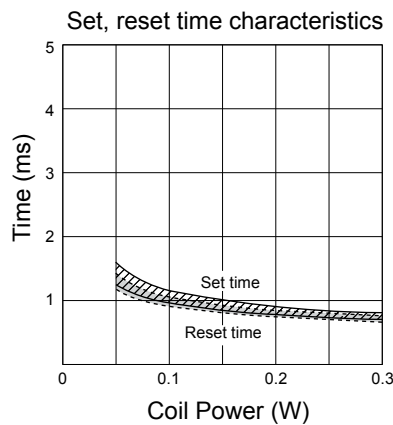
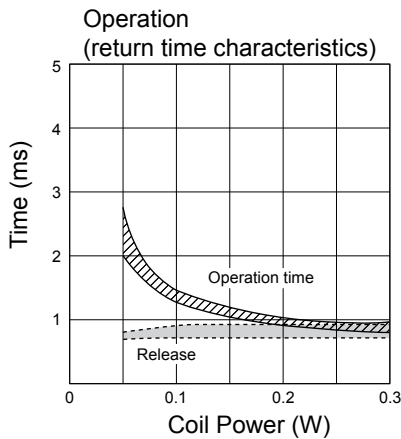

continued

FTR-B3 Series

CHARACTERISTIC DATA

continued

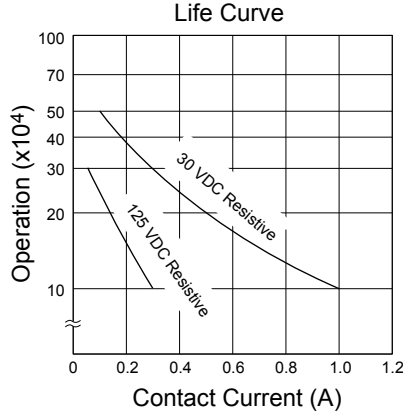
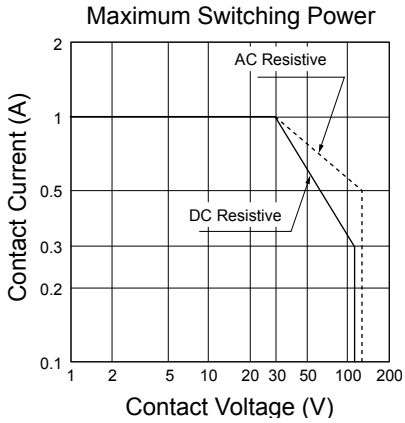

REFERENCE DATA

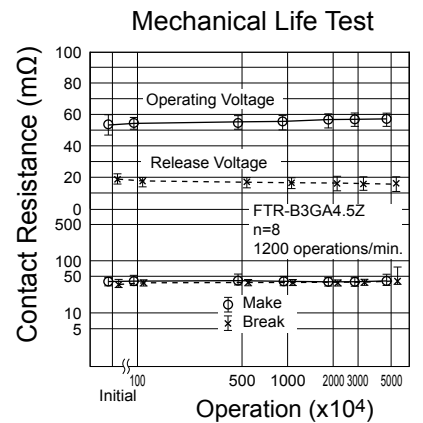
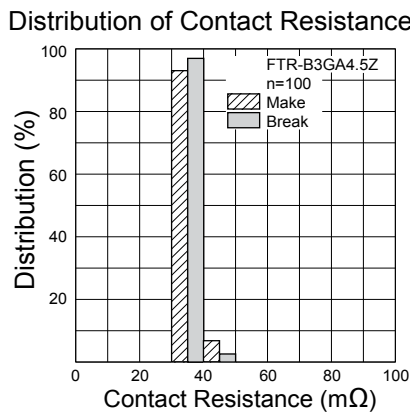
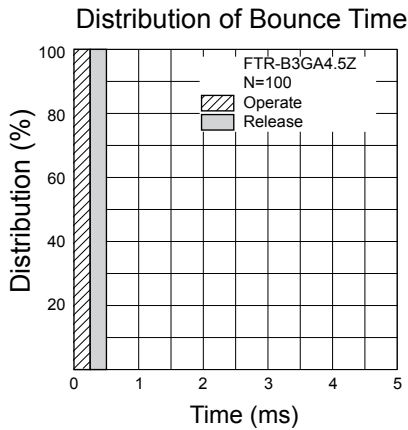
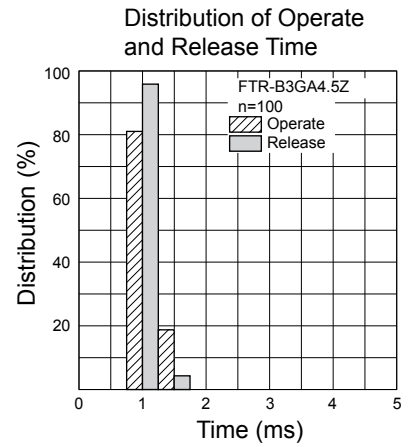
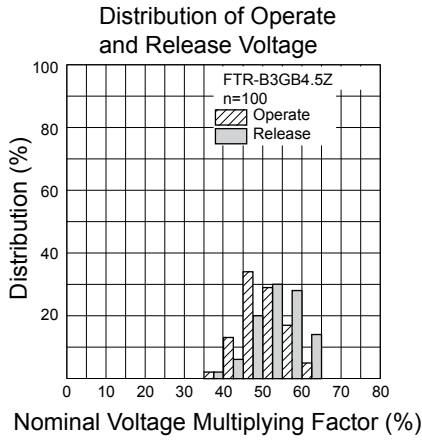
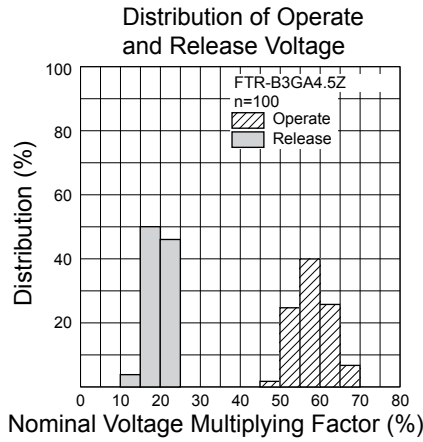

continued

FTR-B3 Series

■ SPECIFICATIONS

continued

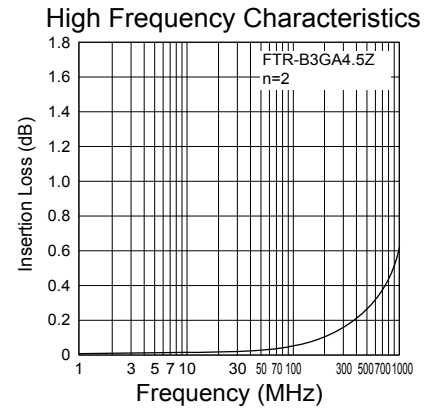
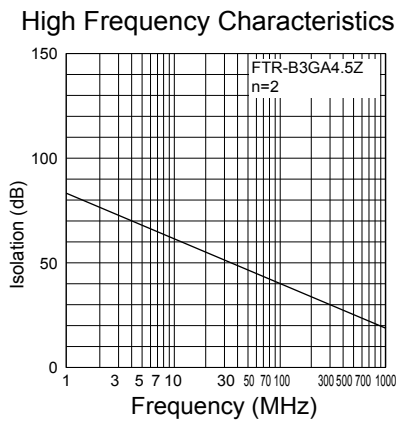
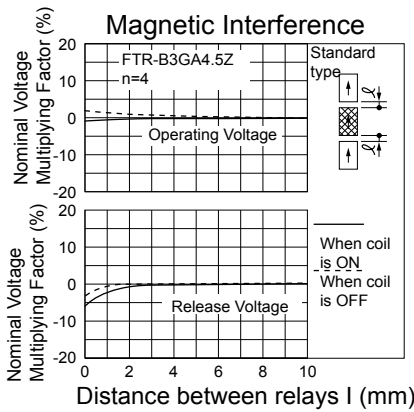
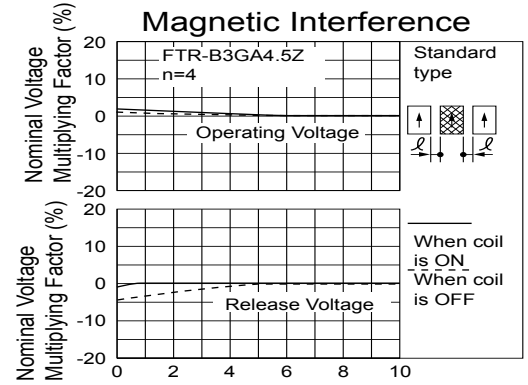
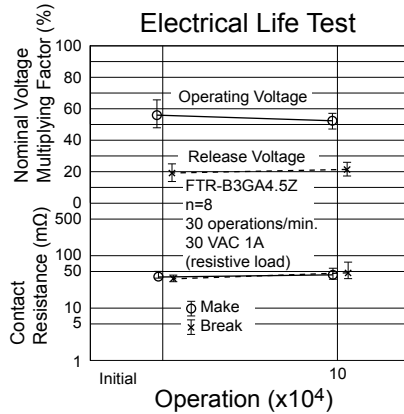
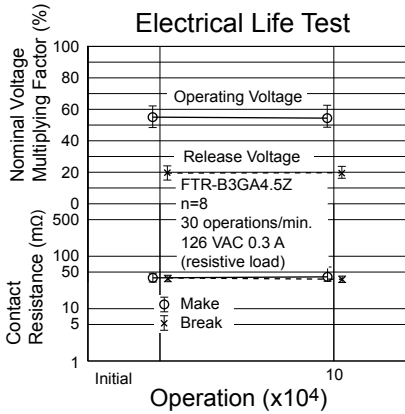

■ DIMENSIONS

FTR-B3C() ()

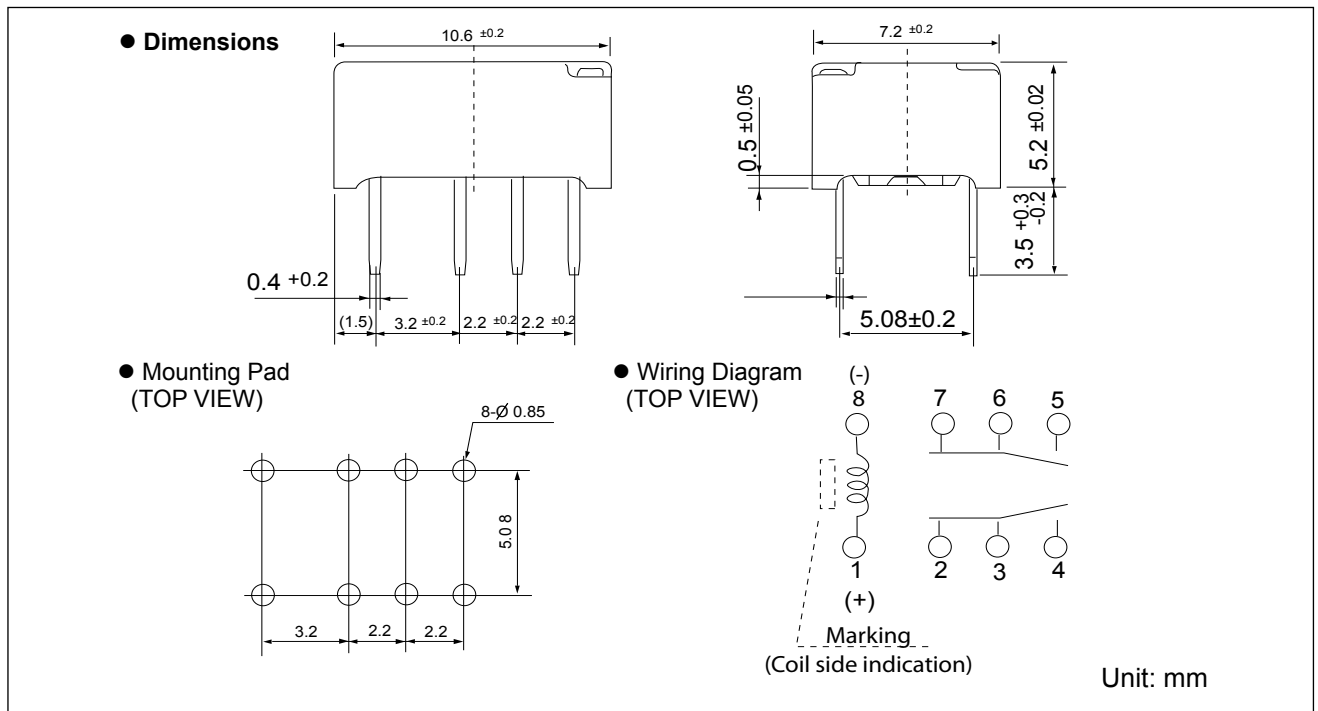

FTR-B3 Series

■ DIMENSIONS

FTR-B3G() ()

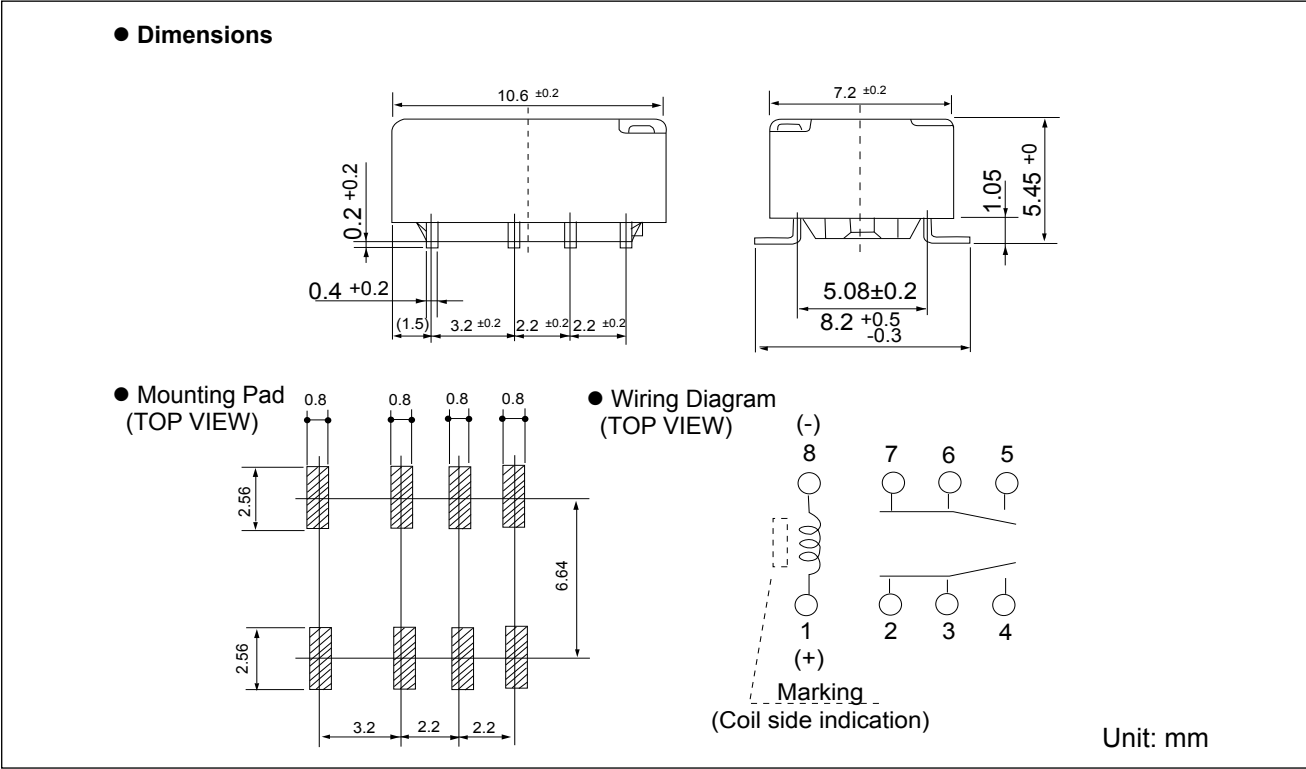

FTR-B3S() ()

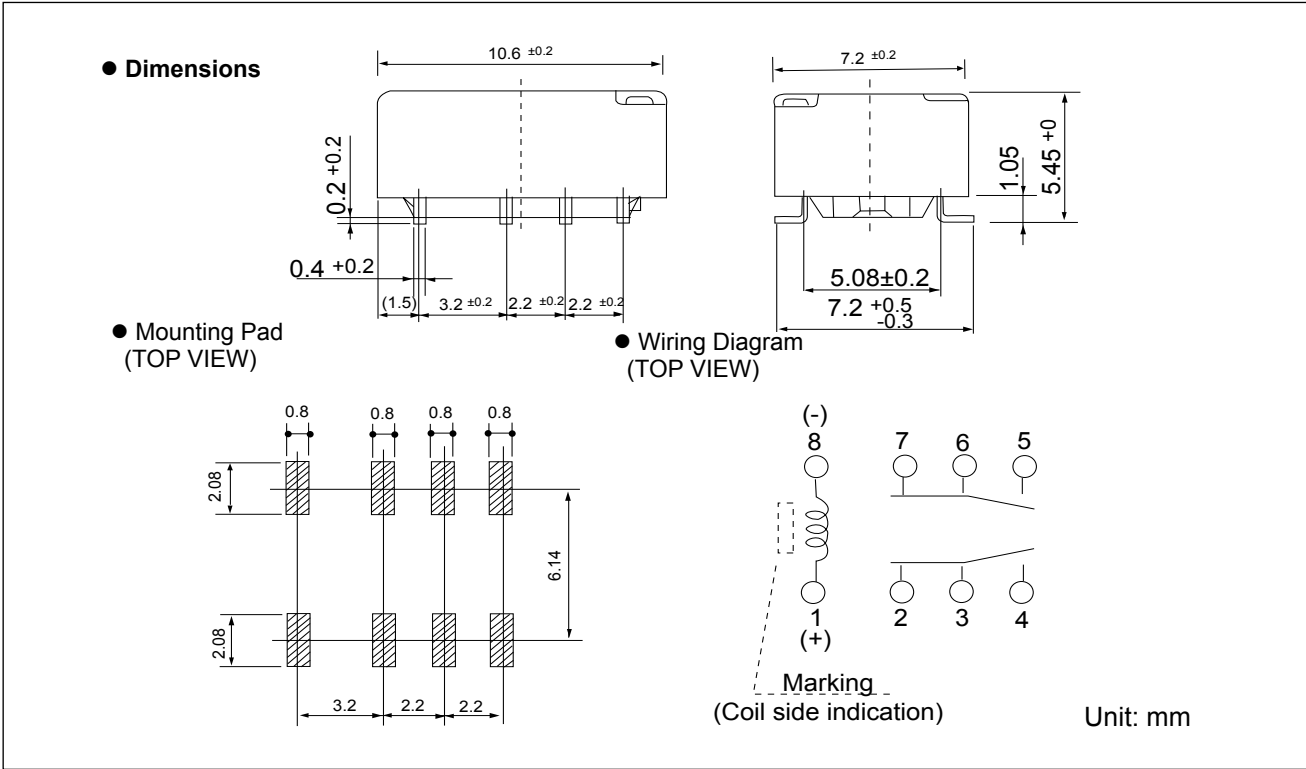

FTR-B3 Series

PACKAGING SPECIFICATIONS

● Packaging Method

- Packaging Standard: JIS C 0806
- Taping Type: TB 1612
- Reel Type: R16D
- Quantity of 1reel: 1000 pieces

● Packaging Orientation Code:B

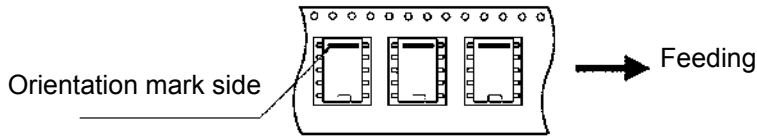

● (2) Dimensions

- Reel dimensions

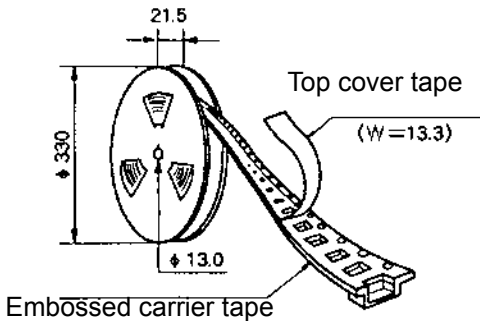

● Tape Dimensions

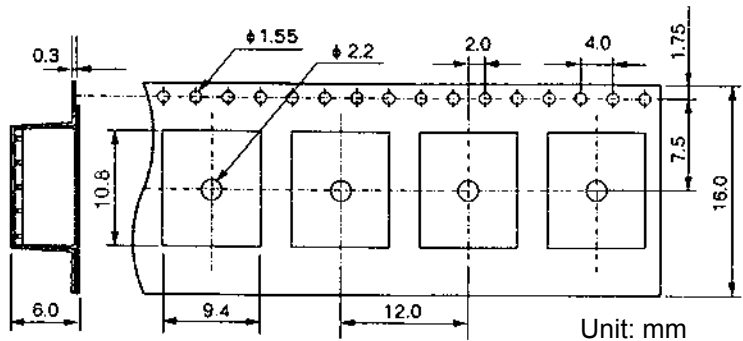

Note: Relays are sold in packs of 1000 pieces, please order 1000 pieces as one unit.

RECOMMENDED SOLDERING CONDITIONS

(TEMPERATURE PROFILE)

IRS (Infrared Reflow Soldering)

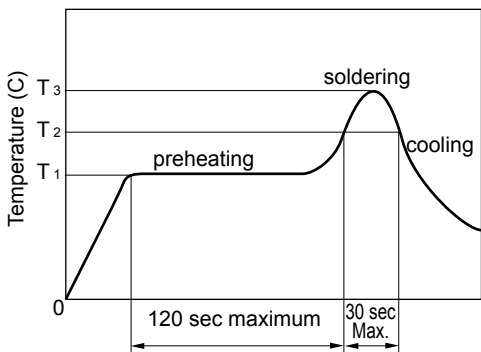

T₃ = 245C max.
T₂ = 200C max.
T₁ = 165C max.

VPS (Vapor Phase Soldering)

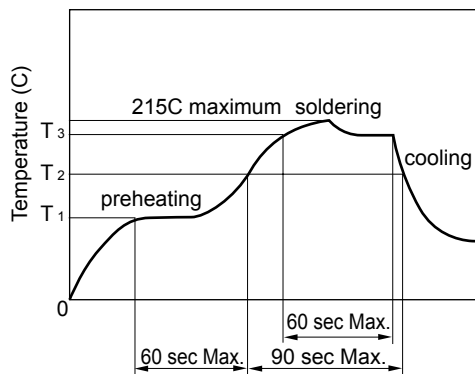

T₃ = 200C maximum
T₂ = 165C maximum
T₁ = 100C maximum

Note: 1. Temperature profiles show the temperature of PC board surface.

2. Please perform soldering test with your actual PC board before mass production, since the temperatures of PC board surfaces vary according to the size of PC board, status of parts mounting and heating method.

PRECAUTIONS

- For details on general precautions, refer to the section on technical descriptions.
- Since this is a polar relay, follow the instructions of the internal wiring diagram for the +- connections of the coil.
- Note that the terminal array and internal wiring of the surface mount relay are a top view

RoHS Compliance and Lead Free Relay Information

1. General Information

- Relays produced after the specific date code that is indicated on each data sheet are lead-free now. Most of our signal and power relays are lead-free. Please refer to Lead-Free Status Info. (<http://www.fujitsu.com/us/downloads/MICRO/fcai/relays/lead-free-letter.pdf>)
- Lead free solder paste currently used in relays is Sn-3.0Ag-0.5Cu. From February 2005 forward Sn-3.0CU-Ni will be used for the FTR-B3 and FTR-B4 series relays.
- All signal and most power relays also comply with RoHS. Please refer to individual data sheets. Relays that are RoHS compliant do not contain the 5 hazardous materials that are restricted by RoHS directive (lead, mercury, chromium IV, PBB, PBDE).
- It has been verified that using lead-free relays in lead assembly process will not cause any problems (compatible).
- "LF" is marked on each outer and inner carton. (No marking on individual relays).
- To avoid leaded relays (for lead-free sample, etc.) please consult with area sales office.
 - We will ship leaded relays as long as the leaded relay inventory exists.

Note: Cadmium was exempted from RoHS on October 21, 2005. (Amendment to Directive 2002/95/EC)

2. Recommended Lead Free Solder Profile

- Recommended solder paste Sn-3.0Ag-0.5Cu and Sn-3.0 Cu-Ni (only FTR-B3 and FTR-B4 from February 2005).

Reflow Solder condition

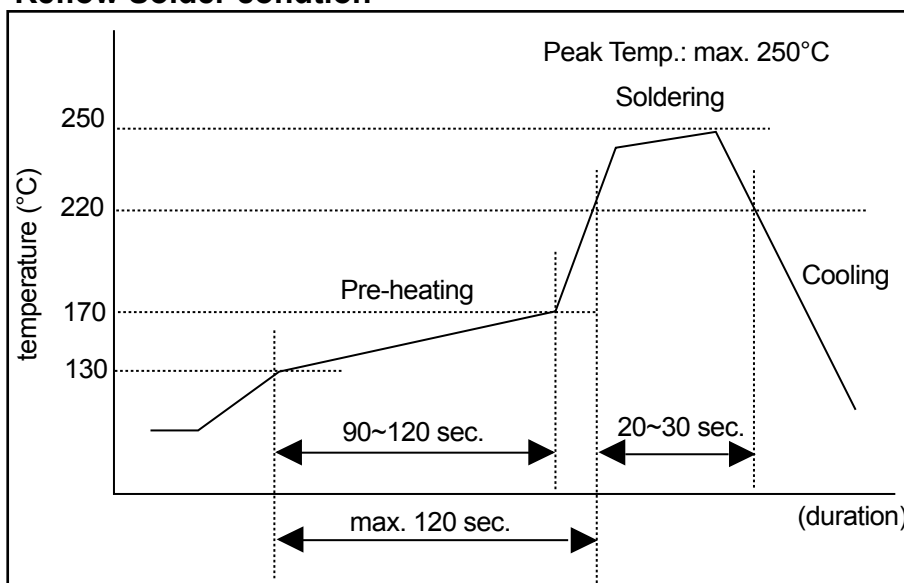

Flow Solder condition:	
Pre-heating:	maximum 120°C
Soldering:	dip within 5 sec. at 260°C solder bath

Solder by Soldering Iron:	
Soldering Iron	
Temperature:	maximum 360°C
Duration:	maximum 3 sec.

We highly recommend that you confirm your actual solder conditions

3. Moisture Sensitivity

- Moisture Sensitivity Level standard is not applicable to electromechanical relays.

4. Tin Whisker

- SnAgCu and SnCuNi solder is known as low risk of tin whisker. No considerable length whisker was found by our in-house test.

FTR-B3 Series

Fujitsu Components International Headquarter Offices

Japan

Fujitsu Component Limited
Gotanda-Chuo Building
3-5, Higashigotanda 2-chome, Shinagawa-ku
Tokyo 141, Japan
Tel: (81-3) 5449-7010
Fax: (81-3) 5449-2626
Email: promothq@ft.ed.fujitsu.com
Web: www.fcl.fujitsu.com

North and South America

Fujitsu Components America, Inc.
250 E. Caribbean Drive
Sunnyvale, CA 94089 U.S.A.
Tel: (1-408) 745-4900
Fax: (1-408) 745-4970
Email: components@us.fujitsu.com
Web: <http://us.fujitsu.com/relays/>

Europe

Fujitsu Components Europe B.V.
Diamantlaan 25
2132 WV Hoofddorp
Netherlands
Tel: (31-23) 5560910
Fax: (31-23) 5560950
Email: info@fceu.fujitsu.com
Web: emea.fujitsu.com/components/

Asia Pacific

Fujitsu Components Asia Ltd.
102E Pasir Panjang Road
#01-01 Citilink Warehouse Complex
Singapore 118529
Tel: (65) 6375-8560
Fax: (65) 6273-3021
Email: fcal@fcal.fujitsu.com
Web: <http://www.fujitsu.com/sg/services/micro/components/>

©2007 Fujitsu Components America, Inc. All rights reserved. All trademarks or registered trademarks are the property of their respective owners.

Fujitsu Components America or its affiliates do not warrant that the content of datasheet is error free. In a continuing effort to improve our products Fujitsu Components America, Inc. or its affiliates reserve the right to change specifications/datasheets without prior notice.
Rev. February 15, 2007