

Bussmann®

Circuit Protection Solutions



COOPER Bussmann

Bussmann®
SAMI

Bussmann®

Worldwide Circuit Protection Solutions

World's leading supplier of fuses and fusible protection systems, Bussmann continues its 88-year history of blazing new trails of innovative technologies. Maker of the industry's first truly global product line, each item is backed by an efficient worldwide network of distribution, customer service and technical support. Bussmann products include the most extensive circuit protection solutions approved for use in a variety of major standards: UL, CSA, IEC. . . Not to mention both European (DIN, British Standard) and North American styled fuses for a wide range of applications: industrial motor protection, power conversion, medium voltage, power distribution, telecommunications network equipment, electronics, and automotive. Manufacturing operations in the U.S., Denmark, and the United Kingdom have earned ISO 9000 certification. Bussmann customers are assured of only the utmost quality across every product line. Knowledgeable. Responsive. Customer focused. Bussmann continues to set the standard for circuit protection solutions around the world.



This catalog is intended to present product data and provide technical information that will help the end user with design application. Bussmann reserves the right, without notice, to change design or construction of any products and to discontinue or limit distribution of any products. Bussmann also reserves the right to change or update, without notice, any technical information contained in this catalog. Once a product has been selected, it should be tested by the user in all possible applications.

Section Guide

	Page
1	1
2	29
3	41
4	99
5	123
6	157
7	175
8	189
9	202
10	210
	231
	233

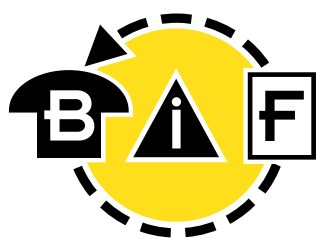

**Bussmann
Information Fax ~
636.527.1450**

**Bussmann
Worldwide Web ~
<http://www.bussmann.com>**

Now you can get current information about Bussmann products at anytime, using **BIF** (Bussmann Information FAX) or visit us on the **World Wide Web**.

BIF is a simple to use automated fax response system. All you need is a touch-tone telephone and a fax machine to get complete product specifications when you want it. Data sheet numbers are located throughout this catalog. To get a detailed data sheet on the product of your choice, simply dial **636-527-1450** and request the document number listed. In a matter of minutes a data sheet will be faxed to you. It's that simple.

Data sheets can also be downloaded from the Internet. The Bussmann web site is continuously updated with our newest products and latest data on circuit protection solutions. Visit us often at <http://www.bussmann.com>

©2002 Cooper Bussmann

Printed in U.S.A.

Table of Contents

Electrical - Power Fuses

General Data (Selection Guide, Dimensional Data)	1-3
Cubefuse (TCF & TCFH)	4-5
Class L Fuses (KRP-C_SP, KTU, KLU)	6-8
Class RK1 Fuses (LPN-RK_SP, LPS-RK_SP, KTN-R, KTS-R)	9-11, 15
Class RK5 Fuses (FRN-R, FRS-R, DLN-R, DLS-R)	12-14
One-Time Fuses (NON, NOS)	16
Class J Fuses (LPJ_SP, JKS)	17-18
Class T Fuses (JJN, JJS)	19
Class G Fuses (SC)	20
Class CC Fuses (LP-CC, FNQ-R, KTK-R)	21-22
Supplementary Fuses (Midget fuses $\frac{13}{32}$ " diameter)	23-25
Plug Fuses	26-27
Cable Limiters and Welder Limiters	28

Electronic Fuses

PC Board and Small Dimension

5mm x 15mm Fuses	29
5mm x 20mm Fuses	30-31
$\frac{1}{4}$ " Diameter Fuses	32-36
Pin Indicating Type Fuses	37-38
Actuators and Limiters	38
In-Line Fuses/Fuseholders	39
Blade-Type Fuses	40

Fuseblocks, Holders and Terminal Blocks

Overcurrent Protection Modules	41-45
Fuse Covers	46
Class H, K, and R	47-52, 63
Class J	53-55, 63
Semiconductor	56
Class J (Touch Safe)	57-58
Class T	59-62
Class CC, G and Type M	64
for $\frac{1}{4}$ " and $\frac{13}{32}$ " Diameter Fuses	66, 83-84, 86
for 5mm Diameter Fuses	85
Modular Fuseblocks and Fuseholders	65, 67
Box Cover Units for Plug Fuses	68
PC Board Mount Fuseholders	69-70
Panel Mount Fuseholders	71-75, 78-79
In-Line Fuseholders	76-77, 80-82
PC Board Fuseclips	87-88
Terminal Blocks	89-93
Rail Mount Fuseholders	94
Power Distribution Blocks	95-97

Disconnect Switches

Disconnects	99
Fusible	99-105, 121
Non-Fusible	106-112
Fusible, Enclosed	113-116
Non Fusible, Enclosed	117-120
Power Modules	122

High Speed Fuses

North American Style	123-130
European Style Square Body	131-147
British Standard BS88	148-150
Ferrule Style	151-158

Medium Voltage Fuses

BBU Boric Acid Fuse	157-158
R-Rated Fuses (Motor Circuit Protection)	161-164
E-Rated Fuses (Transformers Protection)	159-160, 165-168
DIN Dimensions	169
Potential Transformer Fuses	170
Medium Volt, Fast Acting	171
BS2692-1 Fuses	172
Fuse Links	173

Telecommunications

Fused Disconnect Switch	175-181
Telpower Fuses	182-184
Indicating Fuses & Holders	185-186
Specialty Fuses	187-188

British, European, & Canadian Standard Industrial Fuses

CSA Type P and D Fuses	190
HRC Industrial Fuses	191-195
BS88 Low Voltage Industrial Fuses	196-197
DIN Style Type D and Neozed Fuses	198
HRC Fuseholders	199
NH Fuse System	200-201

Fuse Accessories, Displays, Kits, Etc.

Accessories	202-204
Display Racks and Service Kits	205-209

Fuse Technology

Fuseology	210-215
Fuse Diagnostic Chart	216-218
Time-Current & Current Limitation Curves	219-230
Glossary of Terms	231-232

Index	233-234
-------	---------

Buss Fuse Selection Chart (600 Volts or Less)

200,000A or 300,000A Interrupting Rating (rms symmetrical) Current Limiting

Circuit	Load	Ampere Rating	Fuse Type	Symbol	Voltage Rating (a-c)	Class	Interrupting Rating (KA)	Remarks	Page	
Conventional Dimensions—Class RK1, RK5 (0-600A), L (601-6000A)										
Main, Feeder and Branch	All type loads (optimum overcurrent protection).	0-600A	LOW-PEAK® (dual-element, time-delay)	LPN-RK_SP LPS-RK_SP	250V 600V	RK1††	300	All-purpose fuses. Unequaled for combined short-circuit and overload protection. (Specification grade product)	9-11	
		601 to 6000A	LOW-PEAK® (time-delay)	KRP-C_SP	600V	L	300		6-7	
	Motors, welder, transformers, capacitor banks (circuits with heavy inrush currents).	0 to 600A	FUSETRON® (dual-element, time-delay)	FRN-R FRS-R	250V 600V	RK5††	200	Moderate degree of current limitation. Time-delay passes surge currents.	12 13	
		0 to 600A	DURA-LAG™ (dual-element, time-delay)	DLN-R DLS-R	250V 600V	RK5	200		14	
		601 to 4000A	LIMITRON® (time-delay)	KLU	600V	L	200		8	
	Non-motor loads (circuits with no heavy inrush currents). LIMITRON fuses particularly suited for circuit breaker protection.	0 to 600A	LIMITRON® (fast-acting)	KTN-R KTS-R	250V 600V	RK1††	200	Same short-circuit protection as LOW-PEAK fuses but must be sized larger for circuits with surge-currents; i.e., up to 300%.	15	
		601 to 6000A		KTU	600V	L	200		8	
	Reduced Dimensions For Installation in Restricted Space—Class J(0-600A), T(0-1200A), CC(0-30A), G(0-60A)									
	Branch	All type loads (optimum overcurrent protection).	0 to 600A	LOW-PEAK® (dual-element time-delay)	LPJ_SP	600V	J	300	All-purpose fuses. Unequaled for combined short-circuit and overload protection. (Specification grade product)	17
			0 to 600A	LIMITRON® (quick acting)	JKS	600V	J	200		18
Non-motor loads (circuits with no heavy inrush currents).		0 to 1200A	T-TRON™	JJN JJS	300V 600V	T	200	The space saver (1/3 the size of KTN-R/KTS-R).	19	
		0 to 30A	LOW-PEAK® (time-delay)	LP-CC	600V	CC	200		21	
Motor loads (circuits with heavy in-rush currents.)		0 to 30A	LIMITRON® (fast-acting)	KTk-R	600V	CC	200	Very compact (13/32" x 1 1/2"); rejection feature.	22	
Non-motor loads (circuits with no heavy in-rush currents.)		0 to 30A	TRON® (time-delay)	FNQ-R	600V	CC	200	Excellent for control transformer protection.	22	
General purpose; i.e., lighting panel boards.		1 to 20A	SC	SC	600V	G	100	Current limiting; 1 3/32" dia. x varying lengths per amp rating.	20	
		25 to 60A			480V					
Miscellaneous		0 to 600A	ONE-TIME	NON NOS	250V 600V	H or K5†	10	Forerunners of the modern	16	
General Purpose (non-current limiting fuses)		Plug fuses can be used for branch circuits and small component protection.	0 to 30A	FUSTAT® (dual-element, time-delay)	S	125V	S	10	Base threads of Type S differ with amp ratings. T and W have Edison base.	26
			FUSETRON® (dual-element, time-delay)	T	125V	**	10	T & S fuses recommended for motor circuits. W not recommended for circuits with motor loads.		26
			Bus Type W	W	125V	**	10			

** UL Listed as Edison Base Plug Fuse.

† Some ampere ratings are available as UL Class K5 with a 50,000A interrupting rating.

†† RK1 and RK5 fuses fit standard switches, fuseblocks and holders; however, the rejection feature of class R switches and fuseblocks designed specifically for rejection type fuses (RK1 and RK5) prevent the insertion of the non-rejection fuses (K1, K5, and H).

CLASS T

T-Tron™ Fuses

JUN (300V) JJS (600V)

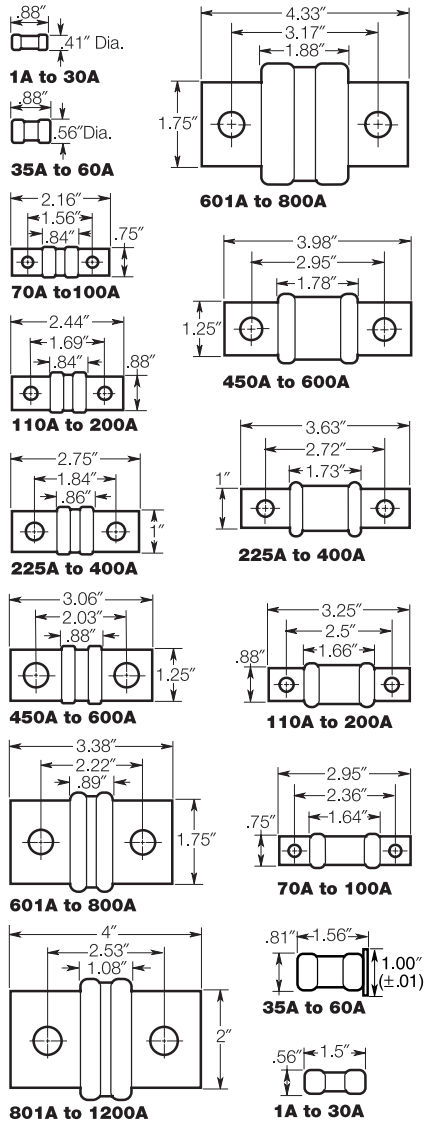

CLASS J

Low-Peak® & Limitron® Fuses

LPJ & JKS (600V)

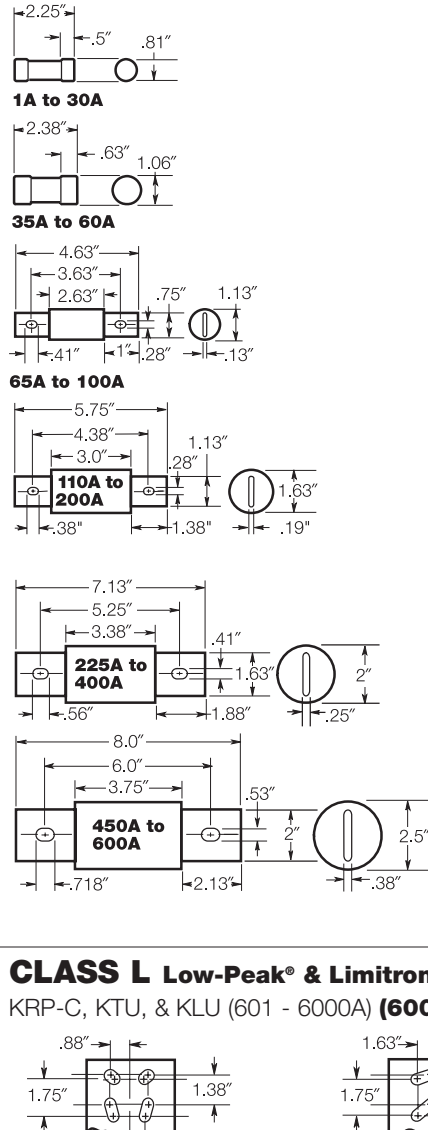

CLASS RK5 & RK1

Fusetron®, Low-Peak® & Limitron® Fuses (250V & 600V)

FRN-R & FRS-R; LPN-RK & LPS-RK; KTN-R & KTS-R

Basic dimensions are same as Class H (formerly NEC) ONE-TIME (NON & NOS) and SUPERLAG Renewable RES & REN fuses.

NOTE: These fuses can be used to replace existing Class H, RK1 and RK5 fuses relating to dimensional compatibility.

Ampere	250V		600V	
	A	B	A	B
1/10-30	2"	.56"	5"	.81"
35-60	3"	.81"	5.5"	1.06"

Ampere	250V		600V	
	A	B	A	B
70-100	5.88"	1.06"	7.88"	1.34"
110-200	7.13"	1.56"	9.63"	1.84"
225-400	8.63"	2.06"	11.63"	2.59"
450-600	10.38"	2.59"	13.38"	3.13"

Ampere	250V		600V	
	A	B	A	B
70-100	5.88"	1.16"	7.88"	1.16"
110-200	7.13"	1.66"	9.63"	1.66"
225-400	8.63"	2.38"	11.63"	2.38"
450-600	10.38"	2.88"	13.38"	2.88"

CLASS L Low-Peak® & Limitron® Fuses

KRP-C, KTU, & KLU (601 - 6000A) (600V)

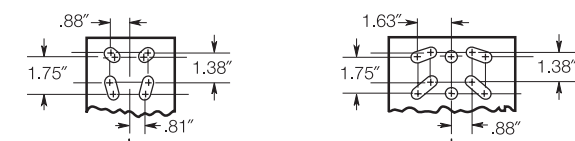

NOTE: KRP-CL (150A to 600A) fuses have same dimensions as 601A to 800A case size. KTU (200A to 600A) have same dimensions, except tube 3" lgth. x 2" dia.; terminal 1 5/8" width x 1 1/4" thick.

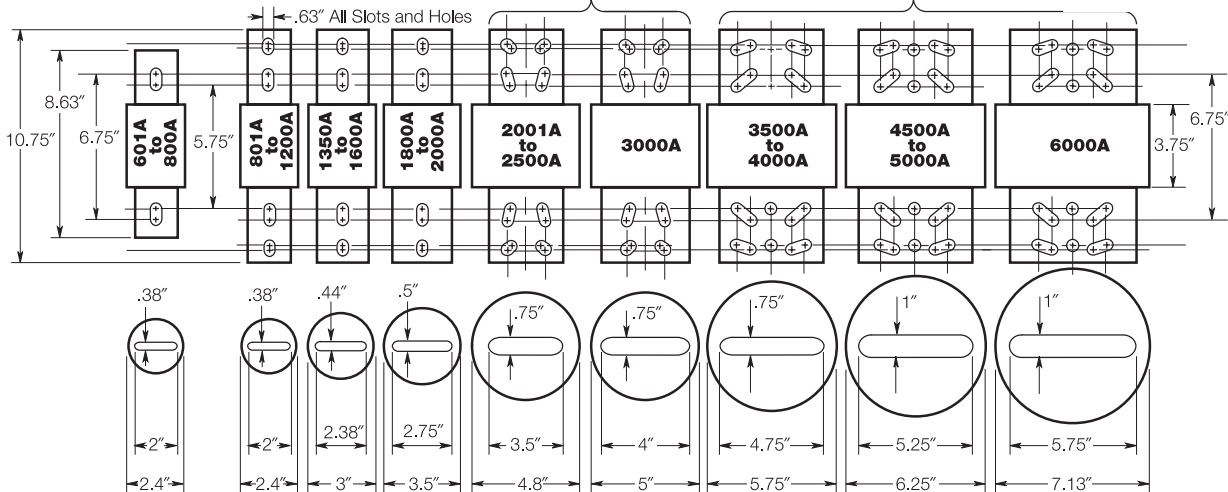

CLASS T

T-Tron™ Fuses

JJN (300V) JJJ (600V)

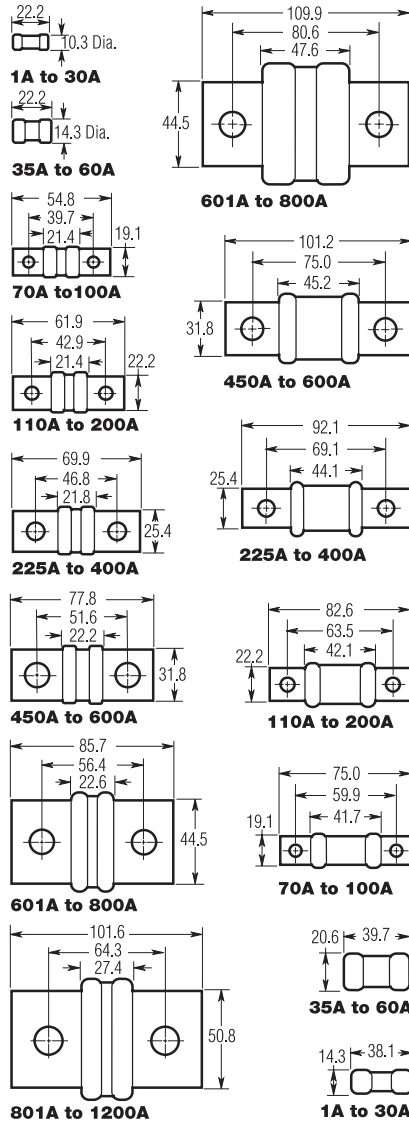

CLASS J

Low-Peak® & Limitron® Fuses

LPJ & JKS (600V)

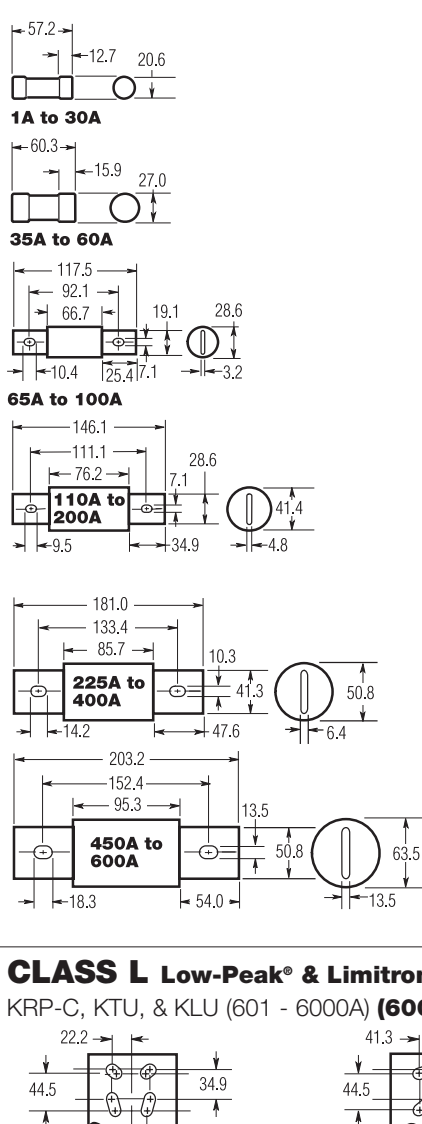

CLASS RK5 & RK1

Fusetron®, Low-Peak® & Limitron® Fuses (250V & 600V)

FRN-R & FRS-R; LPN-RK & LPS-RK; KTN-R & KTS-R

Basic dimensions are same as Class H (formerly NEC) ONE-TIME (NON & NOS) and SUPERLAG Renewable RES & REN fuses.

NOTE: These fuses can be used to replace existing Class H, RK1 and RK5 fuses relating to dimensional compatibility.

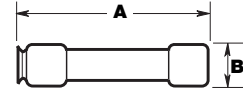

Ampere	250V		600V	
	A	B	A	B
1/10-30	50.8	14.3	127.0	20.6
35-60	76.2	20.6	139.7	27.0



Fusetron & Limitron

Ampere	250V		600V	
	A	B	A	B
70-100	149.2	26.9	200.0	34.0
110-200	181.0	39.6	244.5	46.7
225-400	219.1	52.3	295.3	65.8
450-600	263.5	65.8	339.7	79.5

Low-Peak

Ampere	250V		600V	
	A	B	A	B
70-100	149.2	29.5	200.0	29.5
110-200	181.0	42.2	244.5	42.2
225-400	219.1	60.5	295.3	60.5
450-600	263.5	73.2	339.7	73.2

CLASS L Low-Peak® & Limitron® Fuses

KRP-C, KTU, & KLU (601 - 6000A) (600V)

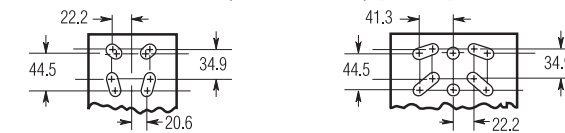

NOTE: KRP-CL (150A to 600A) fuses have same dimensions as 601A to 800A case size. KTU (200A to 600A) have same dimensions, except tube 76.2mm lgth. x 50.8mm dia.; terminal 41.3mm width x 31.8mm thick.

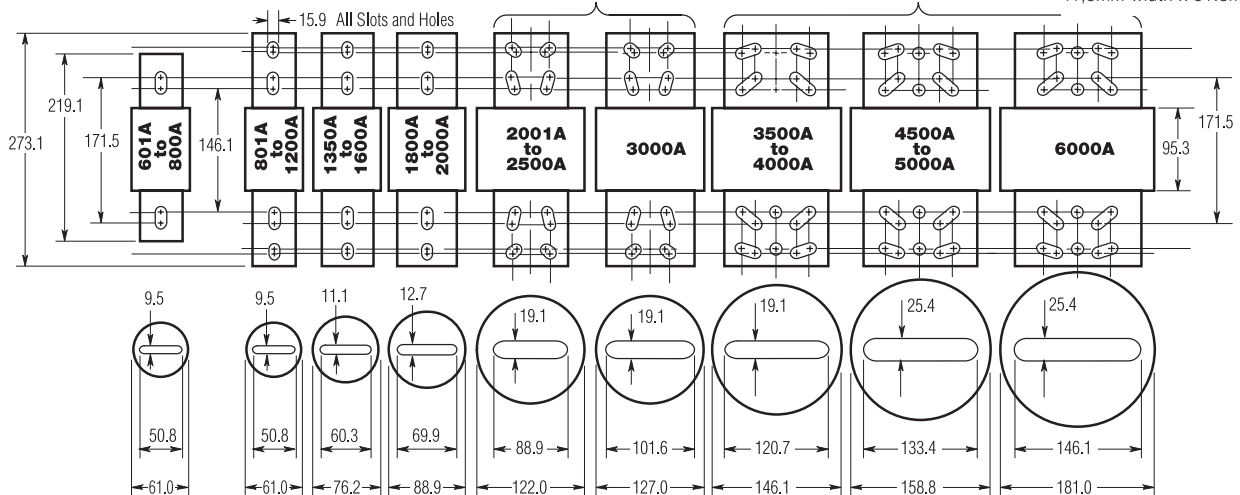

CUBEFUSE™ and Fuseholder
Finger-Safe Dual-Element Time-Delay Fuses
Indicating – 600 Volts or Less

TCF & TCFH
1-60 Amps



Catalog Symbol: TCF (Fuse) & TCFH (Holder)
Dual-Element, Time-Delay Fuse: 10 Seconds
 Minimum Operating Time at 500% Rated Current
Ampere Rating: 1 to 60A
Voltage Rating: 600Vac (or less)
DC Voltage Rating: 300 Vdc (or less), 100,000AIR
Interrupting Rating: 300,000A RMS Symmetrical (UL)
 200,000A RMS Symmetrical (CSA)

Agency Information:
 UL Listed Special Purpose Fuse (UL 248-8) (1-60A)
 CSA Certified Fuse (CSA-22.2 No. 106) (1-60A)
 UL Listed Special Purpose Fuseholder
 CSA Certified Fuseholder (C22.2 Nos. 39 & 65)

Other Electrical Certifications:
 CE compliance for the European Union Low Voltage
 Directive (50-1000Vac, 75-1500Vdc)

Catalog Numbers

TCF1	TCF3	TCF6	TCF10
TCF15	TCF17-1/2	TCF20	TCF25
TCF30	TCF35	TCF40	TCF45
TCF50	TCF60		

CUBEFuse™ Fuseholder Catalog Data

Amps	Poles	Wire *	Dual Wire *	Part Number
30	1	#14 - #8 CU	#14 CU	TCFH30
60	1	#14 - #4 CU	#10 CU	TCFH60

* 75°C (MIN) CU Wire Only

- The world's first finger safe industrial fuse system.
- True dual-element fuse construction with a minimum of 10 seconds time-delay at 500% of rating.
- Long time-delay minimizes nuisance circuit openings due to temporary overloads and transient surges.
- Meets UL Class J Time-Delay electrical performance requirements.
- High interruption rating to safely interrupt faults up to 300,000 amperes.
- Faster response to damaging faults reduces destructive thermal and magnetic forces.
- Permanent open fuse indication.
- Designed to be an internationally accepted and specified world class product.
- Smallest footprint of any power class fuse including Class J, CC, T and RK.
- Meets requirements of IEC 60529 for IP-20 finger safe rating.
- No venting of arc or molten metal and gases during opening.
- Robust cycling and inrush current withstand.
- Low let through currents under fault conditions.
- Provides TYPE 2 "no damage" protection for IEC motors starters when properly sized.
- Low watt loss reduces power consumption and lowers operating temperature.
- Conventional Class J fuse case sizes and ampere ratings.
- Dovetail fuseholder design for ganging multiple fuse poles.
- 30 and 60 Amp fuseholders can be ganged together.
- 30 Amp fuses can be plugged into the 60A holder without a reducer.
- 35mm DIN rail and chassis mounting features.
- Fuseholder wire ports rated for dual wires.

Carton Quantity and Weight

Ampere Rating	Carton.		Weight Per Carton	
	Qty		Lbs.	Kg.
TCF1-30	12		1.39	.518
TCFH1-30	12		2.42	.902
TCF35-60	12		1.42	.530
TCFH35-60	12		2.57	.958

Time-Current and Current Limitation Curves on page 219.



CUBEFUSE™ and Fuseholder
Finger-Safe Dual-Element Time-Delay Fuses
Indicating - 600 Volts or Less

TCF & TCFH

1-60 Amps

Dimensional Data For TCF and TCFH

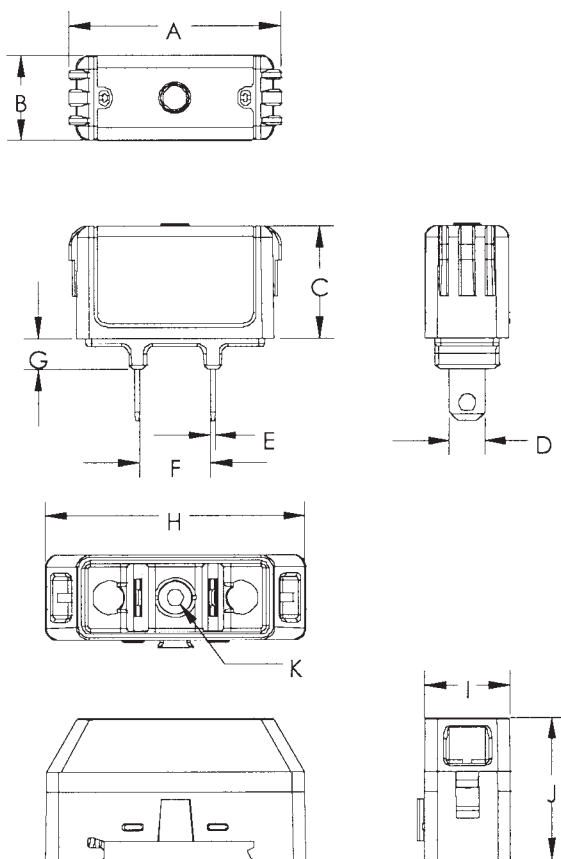

Dimension	30A in [mm]	60A in [mm]
A	1.88 [47.75]	2.13 [54.10]
B	.75 [19.05]	1.00 [25.40]
C	1.00 [25.40]	1.13 [28.58]
D	.31 [7.94]	.44 [11.11]
E	.04 [1.02]	.04 [1.02]
F	.63 [15.88]	.63 [15.88]
G	.27 [6.86]	.38 [9.65]
H	2.30 [58.42]	2.60 [66.04]
I	.76 [19.30]	1.03 [26.16]
J	1.27 [32.18]	1.53 [38.86]
K	.15 [3.81]	.17 [4.32]

Time-Current Characteristic Curves—Average Melt

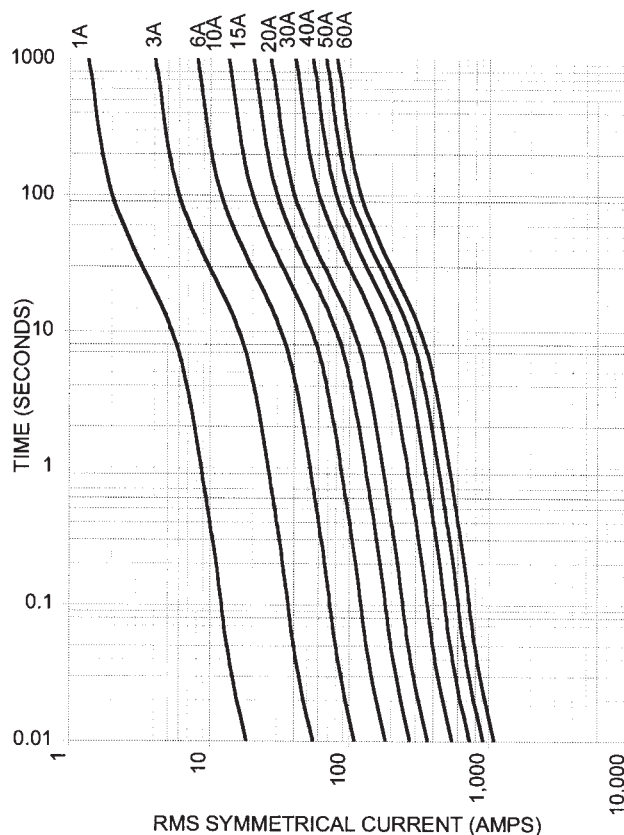

Current Limitation Curves

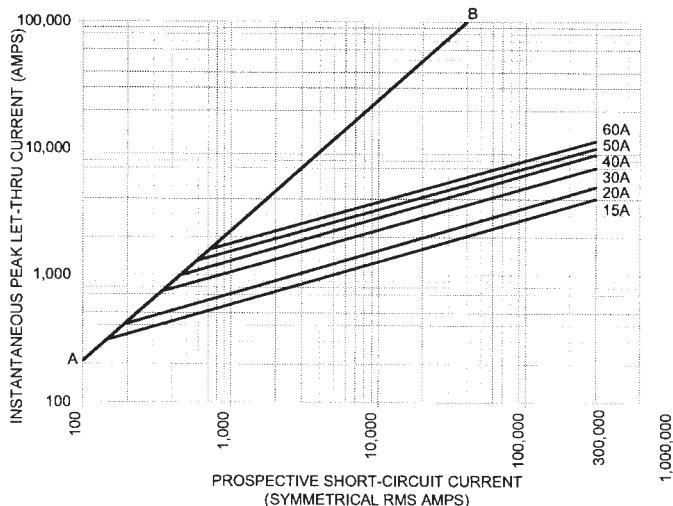

Low-Peak® Time-Delay, Class L Fuses



O-RING SEALS

Formation of arc gas within fuse body suppresses arcing; lowers arcing I²t energy. O-ring seals maximize pressure build-up during current limiting action. Also volume of sand is critical. Slight loss can adversely impact on current limiting action. O-ring seals insure filler retention. They compensate to a degree for switchgear misalignment, and expansion and contraction of mounting surfaces with change in load to no-load conditions.

SAND FILLER

High grade silica-sand filler. Accelerates response of fuse to short-circuits by having quenching effect upon the fuse arc. Substantially contributes to current limiting action.

99.9% PURE SILVER FUSELINKS

Embody "silver-sand" design. 99.9% pure silver links; silica-sand filler. The high conductivity of silver gives low watt loss and low operating temperature at normal current levels; minimizes total clearing I²t fault energy let-thru... state-of-art fuse design. High degree of current limitation holds down fault currents and levels of destructive energy. (Although other link materials can provide current limitation, they do not equal that of silver.)

KRP-C_SP

Time-Delay – 4 seconds (minimum) at 500% rated current

Ampere Ratings: 601-6000A†

Voltage Rating: 600Vac (or less), 300Vdc for 601-2000A.

Interrupting Rating: ac: 300,000A RMS Sym.
dc: 100,000A

Agency Information:

UL Listed-Special Purpose (meets all performance requirements of UL Standard 248-10 for Class L fuses), Guide JFHR, File E56412

CSA Certified (200,000 AIR), Class 1422-02, File 53787, Class L per CSA C22.2, No. 248.10

Dimensions: See pages 2-3 for Class L dimensional data.

- All-purpose silver linked fuse for both overload and short-circuit protection for high capacity systems (mains and large feeders).
- Time-delay (minimum of four seconds at five times amp rating) for close sizing.
- Current limiting action of the fuse generally affords considerable reduction in bus bracing.
- Interrupting rating of 300,000 amperes complies with NEC Sections 110-9 and 230-65 for today's large capacity systems.
- O-ring seals maximize pressure build-up during current limiting action and ensure filler retention.
- High grade silica-sand filler; accelerates response of fuse to short-circuits by having quenching effect upon the fuse arc.
- 99.9% pure silver fuselinks. The high conductivity of silver gives low watt loss and low operating temperature at normal current levels; minimizes total clearing I²t fault energy let-thru.
- Selective coordination (blackout prevention)
- Glass melamine tube.
- Silver plated end bells.
- Reducers not necessary.

Ordering Information

Catalog Number	Ctn. Qty.	Weight**		Catalog Number	Ctn. Qty.	Weight**	
		Lbs.	Kg.			Lbs.	Kg.
KRP-C-601SP	1	3.75	1.7	KRP-C-1800SP	1	8.5	3.85
KRP-C-650SP				KRP-C-1900SP			
KRP-C-700SP				KRP-C-2000SP			
KRP-C-750SP				KRP-C-2001SP			
KRP-C-800SP				KRP-C-2400SP			
KRP-C-801SP	1	4.5	2.041	KRP-C-2500SP	1	17.25	7.824
KRP-C-900SP				KRP-C-3000SP			
KRP-C-1000SP				KRP-C-3500SP			
KRP-C-1100SP				KRP-C-3800SP			
KRP-C-1200SP				KRP-C-4000SP			
KRP-C-1350SP	1	6.50	2.948	KRP-C-4500SP	1	29	13.154
KRP-C-1400SP				KRP-C-5000SP			
KRP-C-1500SP				KRP-C-6000SP			
KRP-C-1600SP							

Special purpose rating of 300,000 AIR.
**Weight per carton.
†Use KRP-CL for current ratings below 601A.

CE logo denotes compliance with European Union Low Voltage Directive (50-1000Vac, 75-1500Vdc). Refer to Data Sheet: 8002 or contact Bussmann Application Engineering at 636-527-1270 for more information.

Data Sheet: 1008 and 1009



Time-Current Characteristic Curves—Average Melt KRP-C

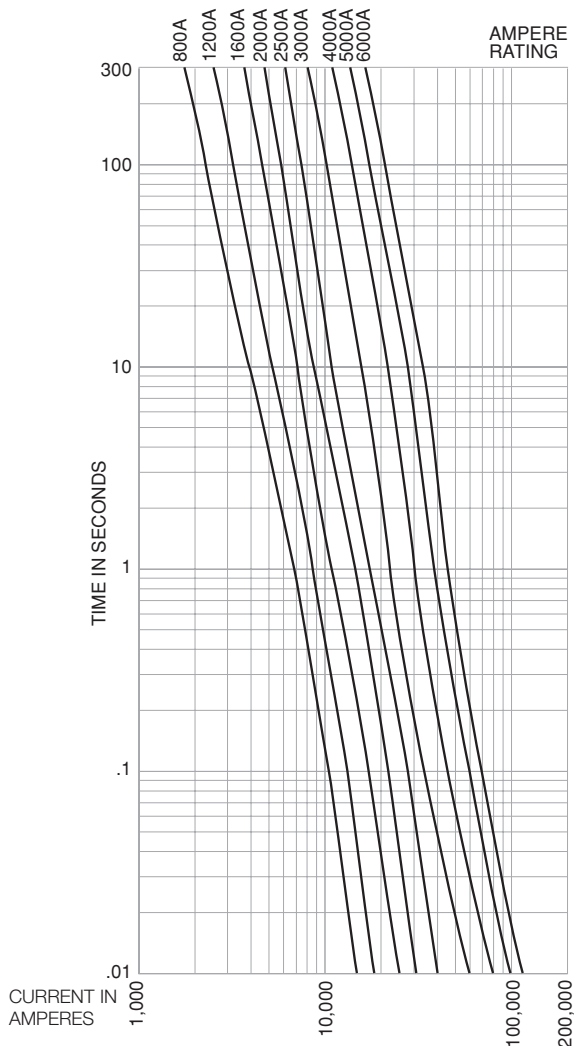

Current Limitation Curves—KRP-C

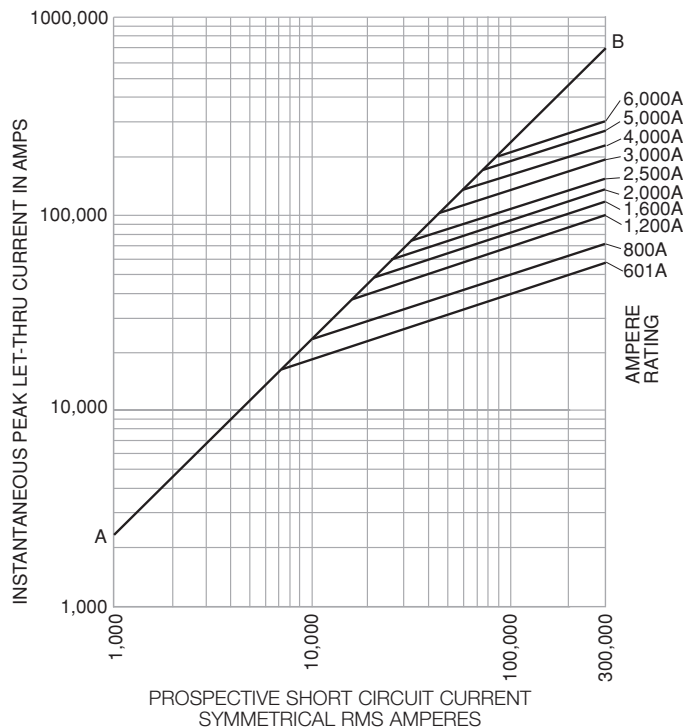

Recommended Fuseblocks for Class L: (601–1200A)

Catalog Number	Poles
51215	1
51235	3

Use KRP-CL for current ratings below 601A.

KRP-CL

Current Limiting, Time-Delay

Construction: Glass Melamine Tube

Ampere Ratings: 150-600A.

Voltage Rating: 600Vac (or less)

These fuses have the same performance characteristics as KRP-C fuses. They are used in applications where there is a need for Class L dimension fuses with 150-600A ratings. KRP-CL fuses have the same dimensions as 800A Class L fuses.

Dimensions: See pages 2-3 for Class L dimensional data.

Ordering Information

Catalog Number (Symbol & Amps)		
KRP-CL-150	KRP-CL-300	KRP-CL-500
KRP-CL-200	KRP-CL-350	KRP-CL-600
KRP-CL-225	KRP-CL-400	
KRP-CL-250	KRP-CL-450	

Weight of each is 3.75 lbs.



Limitron® Class L Fuses



KTU

Fast Acting, Bolt Mount

Ampere Ratings: 601-6000A.

Voltage Rating: 600Vac (or less)

Interrupting Rating: 200,000 RMS Sym.

Agency Information: Std. 248-10, Class L

UL Listed, Guide JDDZ, File E4273

CSA Certified, Class 1422-02, File 53787

Dimensions: See pages 2-3 for Class L dimensional data.

Ordering Information

Catalog Number	Ctn. Qty.	Weight**		Catalog Number	Ctn. Qty.	Weight**	
		Lbs.	Kg.			Lbs.	Kg.
KTU-601	1	3.75	1.70	KTU-1800	1	8.5	3.855
KTU-650				KTU-2000			
KTU-700				KTU-2400	1	17	7.711
KTU-750				KTU-2500			
KTU-800				KTU-3000			
KTU-801	1	4.25	1.927	KTU-3001	1	24	10.886
KTU-900				KTU-4000			
KTU-1100				KTU-4500	1	31	14.061
KTU-1200				KTU-5000			
KTU-1350				KTU-6000			
KTU-1400	1	6	2.721				
KTU-1500							
KTU-1600							

**Weight per carton.

- For protection of circuit breakers with lower interrupting ratings and non-inductive loads such as lighting and heating circuits.
- 99.9% pure silver-links.
- Reducers not necessary.

Recommended Fuseblocks for Class L: (601-1200A)

Catalog Number	Poles
51215	1
51235	3

CE CE logo denotes compliance with European Union Low Voltage Directive (50-1000Vac, 75-1500Vdc). Refer to Data Sheet: 8002 or contact Bussmann Application Engineering at 636-527-1270 for more information.

Data Sheet: 1010



KLU

Time-Delay – 5 seconds (minimum) at 500% rated current

Bolt Mount

Ampere Ratings: 601-4000A.

Voltage Rating: 600Vac (or less)

Interrupting Rating: 200,000A RMS Sym.

Agency Information: Std. 248-10, Class L

UL Listed, Guide JDDZ, File E4273

CSA Certified, CSA Class 1422-02, File 53787

Dimensions: See pages 2-3 for Class L dimensional data.

Ordering Information

Catalog Number	Ctn. Qty.	Weight**		Catalog Number	Ctn. Qty.	Weight**	
		Lbs.	Kg.			Lbs.	Kg.
KLU-601	1	3.75	1.70	KLU-1800	1	8.50	3.86
KLU-650				KLU-2000			
KLU-700				KLU-2500	1	17	7.711
KLU-800				KLU-3000			
KLU-1000				KLU-4000			
KLU-1200	1	4.25	1.93				
KLU-1500	1	6.00	2.72				
KLU-1600							

**Weight per carton.

- KLU Limitron® general purpose copper link fuses.
- Current limiting—provides component short-circuit protection.
- Fuse reducers not necessary.
- See KRP-CL for current ratings below 601A

Recommended Fuseblocks: (601-1200A)

Catalog Number	Poles
51215	1
51235	3

CE CE logo denotes compliance with European Union Low Voltage Directive (50-1000Vac, 75-1500Vdc). Refer to Data Sheet: 8002 or contact Bussmann Application Engineering at 636-527-1270 for more information.

Data Sheet: 1013



Low-Peak® Dual-Element, Time-Delay, Class RK1 Fuses



**LPN-RK_SP (250V)
LPS-RK_SP (600V)**

Dual-Element, Time-Delay – 10 seconds (minimum) at 500% rated current (8 seconds for 0-30A sizes)

Ampere Ratings: 1/10-600A.

Voltage Rating: LPN-RK: 250Vac (or less), 125Vdc (1/10-60A); 250Vdc (70-600 A)

LPS-RK: 600Vac (or less), 300Vdc

Current Limiting RK1 Fuse

Interrupting Rating:

ac: 300,000A RMS Sym.

dc: 100,000A

Agency Information:

UL Listed – Special Purpose**, Guide JFHR, File E56412
CSA Certified (200,000 AIR), Class RK1 per CSA C22.2, No. 248.12, Class 1422-02, File 53787

Dimensions: See pages 2-3 for Class RK1 dimensional data.

Catalog Numbers (250Vac/125Vdc)

LPN-RK-1/10SP	LPN-RK-3 1/2SP	LPN-RK-60SP
LPN-RK-1 9/100SP	LPN-RK-4SP	LPN-RK-70SP
LPN-RK-2 1/10SP	LPN-RK-4 1/2SP	LPN-RK-80SP
LPN-RK-3 1/10SP	LPN-RK-5SP	LPN-RK-90SP
LPN-RK-4 1/10SP	LPN-RK-5 9/10SP	LPN-RK-100SP
LPN-RK-1/2SP	LPN-RK-6SP	LPN-RK-110SP
LPN-RK-9/10SP	LPN-RK-6 1/4SP	LPN-RK-125SP
LPN-RK-8/10SP	LPN-RK-8SP	LPN-RK-150SP
LPN-RK-1SP	LPN-RK-9SP	LPN-RK-175SP
LPN-RK-1 1/8SP	LPN-RK-10SP	LPN-RK-200SP
LPN-RK-1 1/4SP	LPN-RK-12SP	LPN-RK-225SP
LPN-RK-1 1/10SP	LPN-RK-15SP	LPN-RK-250SP
LPN-RK-1 9/10SP	LPN-RK-17 1/2SP	LPN-RK-300SP
LPN-RK-1 8/10SP	LPN-RK-20SP	LPN-RK-350SP
LPN-RK-2SP	LPN-RK-25SP	LPN-RK-400SP
LPN-RK-2 1/4SP	LPN-RK-30SP	LPN-RK-450SP
LPN-RK-2 1/2SP	LPN-RK-35SP	LPN-RK-500SP
LPN-RK-2 9/10SP	LPN-RK-40SP	LPN-RK-600SP
LPN-RK-3SP	LPN-RK-45SP	
LPN-RK-3 9/10SP	LPN-RK-50SP	

**Meets all performance requirements of UL Standard 248-12 for Class RK1 fuses.
0-60A fuses available with Nickel plate option. (Ex: LPSRK30SPNP)
70-600A fuses available with Tin plate option. (Ex: LPS-RK-100SP-TP)

- Current limitation for maximum short-circuit protection. High speed of response is highly sensitive to fault currents, but insensitive to starting current and transient surges.
- Provides long time-delay for temporary motor start-up.
- Time-delay permits 125% FLA sizing for back-up, motor running protection.

Catalog Numbers (600Vac/300Vdc)

LPS-RK-1/10SP	LPS-RK-2 1/2SP	LPS-RK-12SP	LPS-RK-110SP
LPS-RK-2 1/10SP	LPS-RK-2 9/10SP	LPS-RK-15SP	LPS-RK-125SP
LPS-RK-3 1/10SP	LPS-RK-3SP	LPS-RK-17 1/2SP	LPS-RK-150SP
LPS-RK-4 1/10SP	LPS-RK-3 9/10SP	LPS-RK-20SP	LPS-RK-175SP
LPS-RK-1/2SP	LPS-RK-3 1/4SP	LPS-RK-25SP	LPS-RK-200SP
LPS-RK-9/10SP	LPS-RK-4SP	LPS-RK-30SP	LPS-RK-225SP
LPS-RK-8/10SP	LPS-RK-4 1/2SP	LPS-RK-35SP	LPS-RK-250SP
LPS-RK-1SP	LPS-RK-5SP	LPS-RK-40SP	LPS-RK-300SP
LPS-RK-1 1/8SP	LPS-RK-5 9/10SP	LPS-RK-45SP	LPS-RK-350SP
LPS-RK-1 1/4SP	LPS-RK-6SP	LPS-RK-50SP	LPS-RK-400SP
LPS-RK-1 9/10SP	LPS-RK-6 1/4SP	LPS-RK-60SP	LPS-RK-450SP
LPS-RK-1 1/2SP	LPS-RK-7SP	LPS-RK-70SP	LPS-RK-500SP
LPS-RK-1 9/10SP	LPS-RK-8SP	LPS-RK-80SP	LPS-RK-600SP
LPS-RK-1 8/10SP	LPS-RK-9SP	LPS-RK-90SP	
LPS-RK-2 1/4SP	LPS-RK-10SP	LPS-RK-100SP	

**Meets all performance requirements of UL Standard 248-12 for Class RK1 fuses.

Carton Quantity and Weight

LPN-RK (250Vac)		LPS-RK (600Vac)				
Ampere Ratings	Carton Qty.	Weight*		Carton Qty.	Weight*	
		Lbs.	Kg		Lbs.	Kg
0-30	10	0.5	0.227	10	1.6	0.725
35-60	10	1.2	0.544	10	2.6	1.178
70-100	5	1.5	0.680	5	4.0	1.814
110-200	1	0.69	0.313	1	2.0	0.906
225-400	1	1.75	0.793	1	4.6	2.086
450-600	1	3.25	1.474	1	5.6	2.540

*Weight per carton.

CE CE logo denotes compliance with European Union Low Voltage Directive (50-1000Vac, 75-1500Vdc). Refer to Data Sheet: 8002 or contact Bussmann Application Engineering at 636-527-1270 for more information.



Data Sheet: (LPN-RK) 1003 (0-60) & 1004 (70-600)

Data Sheet: (LPS-RK) 1001 (0-60) & 1002 (70-600)

For complete specification data, call Bussmann Information Fax ~ 636.527.1450

Low-Peak® Dual-Element, Time-Delay, Class RK1 Fuses

Time-Current Characteristic Curves—Average Melt

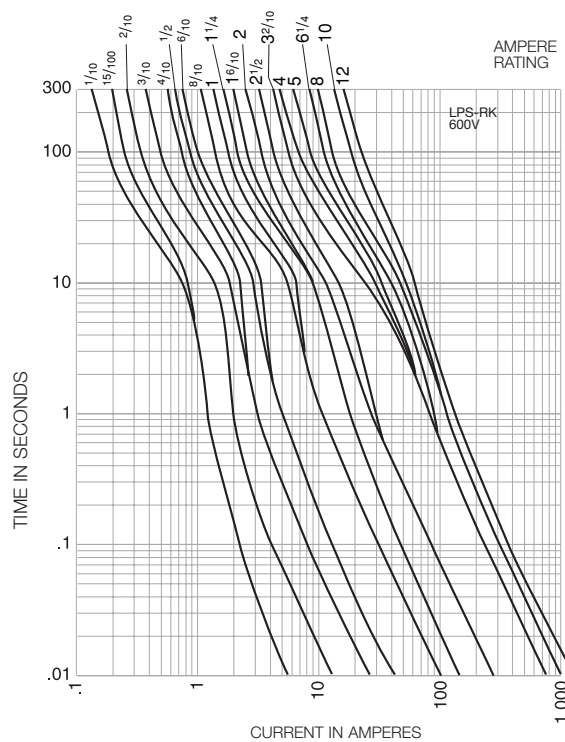
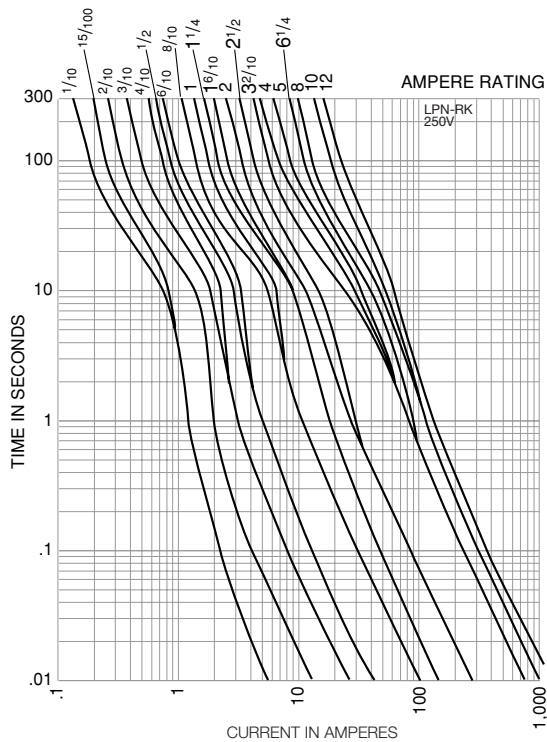
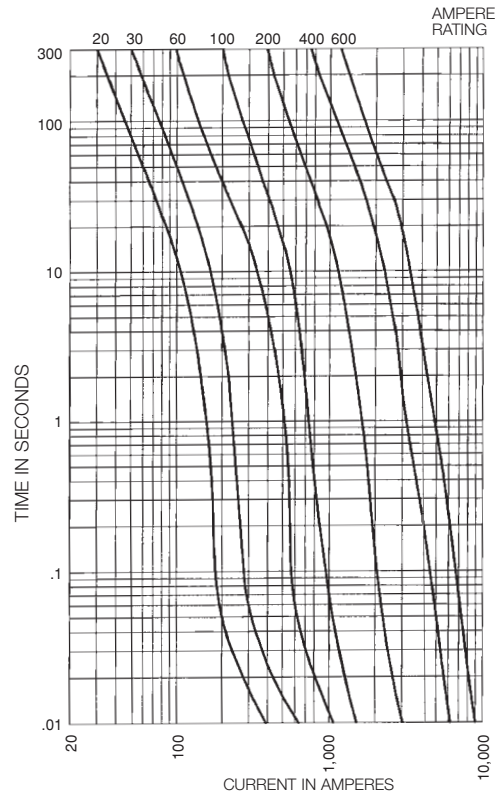
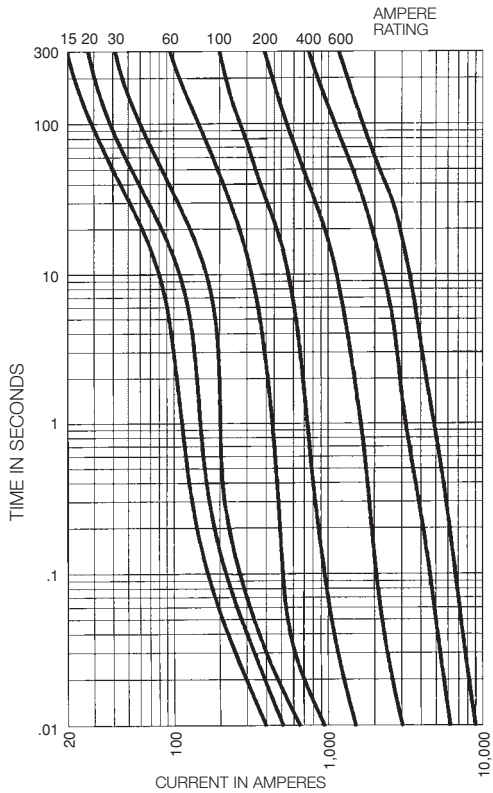

Data Sheet: (LPN-RK) 1003 (0-60) & 1004 (70-600)

Data Sheet: (LPS-RK) 1001 (0-60) & 1002 (70-600)



Low-Peak® Dual-Element, Time-Delay, Class RK1 Fuses



Recommended fuseblocks for Class R 250 & 600V fuses See pages 47-52

Current Limitation Curves—LPN-RK (250V)

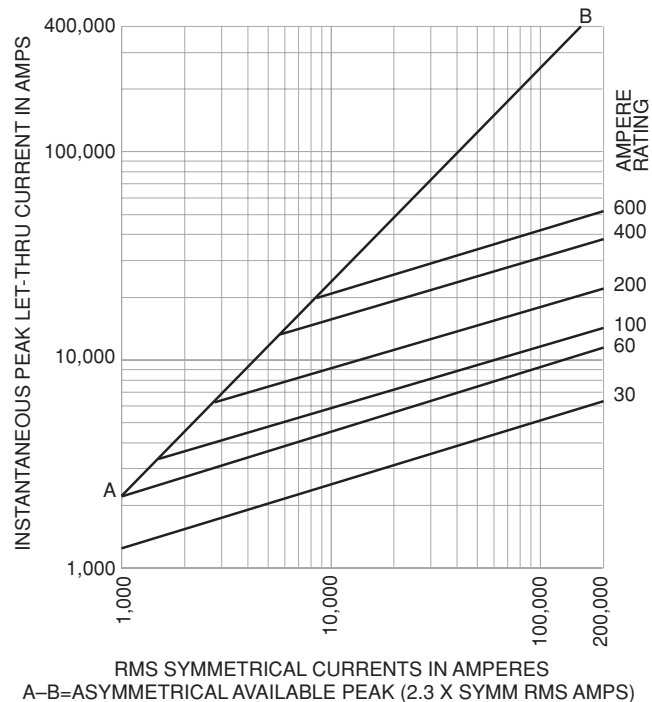

Current Limitation Curves—LPS-RK (600V)

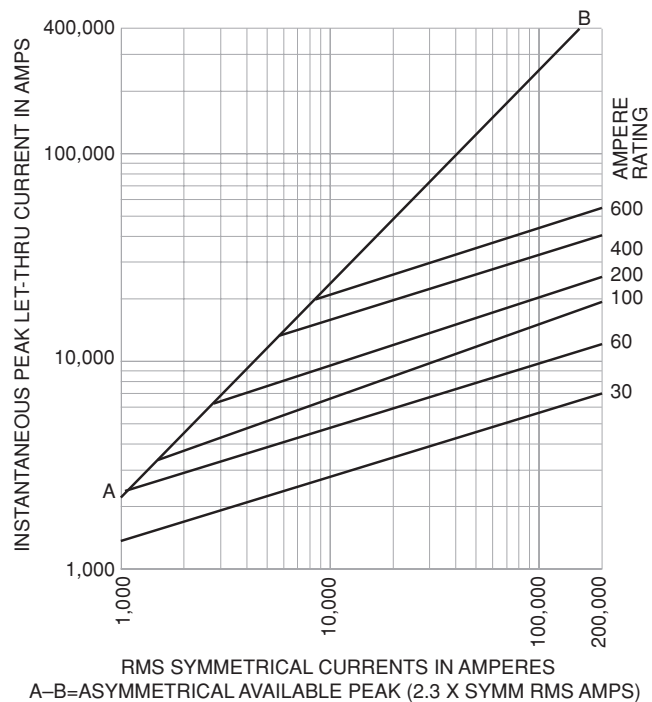

Data Sheet: (LPN-RK) 1003 (0-60) & 1004 (70-600)

Data Sheet: (LPS-RK) 1001 (0-60) & 1002 (70-600)



For complete specification data, call Bussmann Information Fax ~ 636.527.1450

Fusetron® Dual-Element, Time-Delay, Class RK5 Fuses



FRN-R (250V)

Dual-Element, Time-Delay – 10 seconds (minimum) at 500% rated current

Ampere Ratings: 1/10-600A.

Voltage Rating: 250Vac (or less), 125Vdc

Current Limiting RK5 Fuse

Interrupting Rating: 200,000A RMS Sym. (20,000A @ 125Vdc)

Agency Information: Std. 248-12, Class RK5

UL Listed, Guide JDDZ, File E4273

CSA Certified, Class 1422-01, File 53787

Dimensions: See pages 2-3 for Class RK5 dimensional data.

Catalog Numbers (250Vac/125Vdc)

FRN-R-1/10	FRN-R-2	FRN-R-10	FRN-R-100
FRN-R-1/8	FRN-R-2 1/4	FRN-R-12	FRN-R-110
FRN-R-1 5/100	FRN-R-2 1/2	FRN-R-15	FRN-R-125
FRN-R-3/10	FRN-R-2 3/10	FRN-R-17 1/2	FRN-R-150
FRN-R-1/4	FRN-R-3	FRN-R-20	FRN-R-175
FRN-R-3/10	FRN-R-3 2/10	FRN-R-25	FRN-R-200
FRN-R-4/10	FRN-R-3 1/2	FRN-R-30	FRN-R-225
FRN-R-1/2	FRN-R-4	FRN-R-35	FRN-R-250
FRN-R-5/10	FRN-R-4 1/2	FRN-R-40	FRN-R-300
FRN-R-6/10	FRN-R-5	FRN-R-45	FRN-R-350
FRN-R-1	FRN-R-5 5/10	FRN-R-50	FRN-R-400
FRN-R-1 1/8	FRN-R-6	FRN-R-60	FRN-R-450
FRN-R-1 1/4	FRN-R-6 1/4	FRN-R-70	FRN-R-500
FRN-R-1 1/10	FRN-R-7	FRN-R-75	FRN-R-600
FRN-R-1 1/2	FRN-R-7 1/2	FRN-R-80	
FRN-R-1 5/10	FRN-R-8	FRN-R-85	
FRN-R-1 9/10	FRN-R-9	FRN-R-90	

Carton Quantity and Weight

Ampere Ratings	Carton Qty.	Weight*	
		Lbs.	Kg.
0-15	10	0.40	0.181
17.5-30	10	.50	0.227
35-60	10	1.00	0.453
70-100	5	1.5	0.680
101-200	1	0.77	0.349
201-400	1	1.52	0.689
401-600	1	2.94	1.334

*Weight per carton.

- Provides motor overload, ground fault and short-circuit protection when sized properly.
- Helps protect motors against burnout from overloads when sized properly.
- Helps protect motors against burnout from single phasing on three phase systems when sized properly.
- Simplifies and improves blackout prevention (selective coordination) when sized properly.

Fuse Reducers For Class R Fuses

Equipment Fuse Clips	Desired Fuse (Case) Size	Catalog Number (Pairs) 250V
60A	30A	No. 263-R
100A	30A	No. 213-R
	60A	No. 216-R
200A	60A	No. 226-R
	100A	No. 2621-R
	100A	No. 2641-R
400A	200A	No. 242-R
	100A	No. 2661-R
600A	200A	No. 2662-R
	400A	No. 2664-R*

*Single reducer only (pair not required).

Time-Current and Current Limitation Curves located on page 223.



Recommended fuseblocks for Class R 250V fuses
See pages 47-49

CE CE logo denotes compliance with European Union Low Voltage Directive (50-1000Vac, 75-1500Vdc). Refer to Data Sheet: 8002 or contact Bussmann Application Engineering at 636-527-1270 for more information.

Data Sheet: 1019 (0-60), 1020 (70-600)



Fusetron® Dual-Element, Time-Delay, Class RK5 Fuses



FRS-R (600V)

Dual-Element, Time-Delay – 10 seconds (minimum) at 500% rated current

Ampere Ratings: 1/10-600A.

Voltage Rating: 600Vac (or less), 300Vdc

Current Limiting RK5 Fuse

Interrupting Rating: 200,000A RMS Sym. (20,000A @ 300Vdc)

Agency Information: Std. 248-12, Class RK5

UL Listed, Guide JDDZ, File E4273

CSA Certified, Class 1422-02, File 53787

Dimensions: See pages 2-3 for Class RK5 dimensional data.

Catalog Numbers (600Vac/ 300Vdc)

FRS-R-1/10	FRS-R-2	FRS-R-10	FRS-R-110
FRS-R-1/8	FRS-R-2 1/4	FRS-R-12	FRS-R-125
FRS-R-15/100	FRS-R-2 1/2	FRS-R-15	FRS-R-150
FRS-R-3/10	FRS-R-2 3/4	FRS-R-17 1/2	FRS-R-175
FRS-R-1/4	FRS-R-3	FRS-R-20	FRS-R-200
FRS-R-3/10	FRS-R-3 1/2	FRS-R-25	FRS-R-225
FRS-R-4/10	FRS-R-4	FRS-R-30	FRS-R-250
FRS-R-1/2	FRS-R-4 1/2	FRS-R-35	FRS-R-275
FRS-R-5/10	FRS-R-5	FRS-R-40	FRS-R-300
FRS-R-6/10	FRS-R-5 1/2	FRS-R-45	FRS-R-325
FRS-R-1	FRS-R-6	FRS-R-50	FRS-R-350
FRS-R-1 1/8	FRS-R-6 1/4	FRS-R-60	FRS-R-400
FRS-R-1 1/4	FRS-R-7	FRS-R-70	FRS-R-450
FRS-R-1 1/2	FRS-R-7 1/2	FRS-R-80	FRS-R-500
FRS-R-1 3/4	FRS-R-8	FRS-R-90	FRS-R-600
FRS-R-2	FRS-R-9	FRS-R-100	

Carton Quantity and Weight

Ampere Ratings	Carton Qty.	Weight*	
		Lbs.	Kg.
0-15	10	0.40	0.181
17.5-30	10	0.50	0.227
35-60	10	3.10	1.406
65-100	1	0.54	0.245
101-200	1	1.22	0.544
201-400	1	3.00	1.359
401-600	1	5.00	2.268

*Weight per carton.

Fuse Reducers For Class R Fuses

Equipment Fuse Clips	Desired Fuse (Case) Size	Catalog Number (Pairs) 600V
60A	30A	No. 663-R
100A	30A	No. 216-R
	60A	No. 616-R
200A	60A	No. 626-R
	100A	No. 2621-R
400A	100A	No. 2641-R
	200A	No. 642-R
600A	100A	No. 2661-R
	200A	No. 2662-R
	400A	No. 2664-R*

*Single reducer only (pair not required).

Time-Current and Current Limitation Curves located on page 224.



Recommended fuseblocks for Class R 600V fuses
See pages 50-52

CE CE logo denotes compliance with European Union Low Voltage Directive (50-1000Vac, 75-1500Vdc). Refer to Data Sheet #8002 or contact Bussmann Application Engineering at 636-527-1270 for more information.



Dura-Lag™ Dual-Element, Time-Delay, Class RK5 Fuses



DLN-R (250V)

Dual-Element, Time-Delay – 10 seconds (minimum) at 500% rated current

Ampere Ratings: 1-600A

Voltage Rating: 250Vac (or less), 125Vdc

Current Limiting RK5 Fuses

Interrupting Rating: 200,000A RMS Sym. (20,000A @125Vdc)

Agency Information: Std. 248-12, Class RK5

UL Listed, Guide JDDZ, File E4273

CSA C22.2, No. 106-HRCI-R, File 53787

Dimensions: See pages 2-3 for Class RK5 dimensional data.

Catalog Numbers (250Vac/125Vdc)

DLN-R-1	DLN-R-15	DLN-R-100
DLN-R-2	DLN-R-20	DLN-R-125
DLN-R-2½	DLN-R-25	DLN-R-150
DLN-R-3	DLN-R-30	DLN-R-175
DLN-R-3¾	DLN-R-35	DLN-R-200
DLN-R-4	DLN-R-40	DLN-R-225
DLN-R-5	DLN-R-45	DLN-R-250
DLN-R-6	DLN-R-50	DLN-R-300
DLN-R-6¾	DLN-R-60	DLN-R-400
DLN-R-8	DLN-R-70	DLN-R-600
DLN-R-10	DLN-R-80	
DLN-R-12	DLN-R-90	

Carton Quantity and Weight

Ampere Ratings	Carton Qty.	Weight*	
		Lbs.	Kg.
¼-30	10	0.56	0.252
35-60	10	1.38	0.621
70-100	5	1.56	0.702
110-200	1	0.90	0.405
225-400	1	1.80	0.810
450-600	1	3.30	1.485

*Weight per carton.



Recommended fuseblocks for Class R 250V fuses
See pages 47-49

CE CE logo denotes compliance with European Union Low Voltage Directive (50-1000Vac, 75-1500Vdc). Refer to Data Sheet: 8002 or contact Bussmann Application Engineering at 636-527-1270 for more information.

Data Sheet: 1021 (0-600)



DLS-R (600V)

Dual-Element, Time-Delay – 10 seconds (minimum) at 500% rated current

Ampere Ratings: 1-600A

Voltage Rating: 600Vac (or less), 300Vdc

Current Limiting RK5 Fuses

Interrupting Rating: 200,000A RMS Sym. (20,000A @ 300Vdc)

Agency Information: Std. 248-12, Class RK5

UL Listed, Guide JDDZ, File E4273

CSA C22.2, No. 106-HRCI-R

Dimensions: See pages 2-3 for Class RK5 dimensional data.

Catalog Numbers (600Vac/300Vdc)

DLS-R-1	DLS-R-12	DLS-R-100
DLS-R-1½	DLS-R-15	DLS-R-110
DLS-R-2	DLS-R-17½	DLS-R-125
DLS-R-2½	DLS-R-20	DLS-R-150
DLS-R-3	DLS-R-25	DLS-R-175
DLS-R-3½	DLS-R-30	DLS-R-200
DLS-R-4	DLS-R-35	DLS-R-225
DLS-R-5	DLS-R-40	DLS-R-250
DLS-R-6	DLS-R-45	DLS-R-300
DLS-R-6¾	DLS-R-50	DLS-R-350
DLS-R-7	DLS-R-60	DLS-R-400
DLS-R-8	DLS-R-70	DLS-R-500
DLS-R-9	DLS-R-80	DLS-R-600
DLS-R-10	DLS-R-90	

Carton Quantity and Weight

Ampere Ratings	Carton Qty.	Weight*	
		Lbs.	Kg.
¼-30	10	1.62	0.729
35-60	10	3.00	1.35
70-100	5	3.00	1.35
110-200	1	1.41	0.635
225-400	1	3.13	1.409
450-600	1	5.28	2.376

*Weight per carton.



Recommended fuseblocks for Class R 600V fuses
See pages 50-52

CE CE logo denotes compliance with European Union Low Voltage Directive (50-1000Vac, 75-1500Vdc). Refer to Data Sheet: 8002 or contact Bussmann Application Engineering at 636-527-1270 for more information.

Data Sheet: 1022 (0-600)



Limitron® Fast Acting, Class RK1 Fuses



KTN-R (250V)

Fast Acting

Ampere Ratings: 1-600A

Voltage Rating: 250Vac (or less).

Current Limiting RK1 Fuse (curves on page 205)

Interrupting Rating: 200,000A RMS Sym.

Agency Information: Std. 248-12, Class RK1

UL Listed, Guide JDDZ, File E54273

CSA Certified, Class 1422-02, File 53787

Dimensions: See pages 2-3 for Class RK1 dimensional data.

Catalog Numbers (250Vac)

KTN-R-1	KTN-R-30	KTN-R-125
KTN-R-2	KTN-R-35	KTN-R-150
KTN-R-3	KTN-R-40	KTN-R-175
KTN-R-4	KTN-R-45	KTN-R-200
KTN-R-5	KTN-R-50	KTN-R-225
KTN-R-6	KTN-R-60	KTN-R-250
KTN-R-8	KTN-R-70	KTN-R-300
KTN-R-10	KTN-R-75	KTN-R-350
KTN-R-12	KTN-R-80	KTN-R-400
KTN-R-15	KTN-R-90	KTN-R-450
KTN-R-20	KTN-R-100	KTN-R-500
KTN-R-25	KTN-R-110	KTN-R-600

Carton Quantity and Weight

Ampere Ratings	Carton Qty.	Weight*	
		Lbs.	Kg.
1-30	10	.45	0.204
40-60	10	1.82	0.824
70-100	5	1.85	0.838
110-200	1	1.05	0.476
225-400	1	2.38	1.078
450-600	1	3.50	1.587

*Weight per carton.

Time-Current and Current Limitation Curves located on page 225.



Recommended fuseblocks for Class R 250V fuses
See pages 47-49

CE logo denotes compliance with European Union Low Voltage Directive (50-1000Vac, 75-1500Vdc). Refer to Data Sheet: 8002 or contact Bussmann Application Engineering at 636-527-1270 for more information.



KTS-R (600V)

Fast Acting

Ampere Ratings: 1-600A

Voltage Rating: 600Vac (or less).

Current Limiting RK1 Fuse (curves on page 206)

Interrupting Rating: 200,000A RMS Sym.

Agency Information: Std. 248-12, Class RK1

UL Listed, Guide JDDZ, File E54273

CSA Certified, Class 1422-02, File 53787

Dimensions: See pages 2-3 for Class RK1 dimensional data.

Catalog Numbers (600Vac)

KTS-R-1	KTS-R-30	KTS-R-125
KTS-R-2	KTS-R-35	KTS-R-150
KTS-R-3	KTS-R-40	KTS-R-175
KTS-R-4	KTS-R-45	KTS-R-200
KTS-R-5	KTS-R-50	KTS-R-225
KTS-R-6	KTS-R-60	KTS-R-250
KTS-R-8	KTS-R-70	KTS-R-300
KTS-R-10	KTS-R-75	KTS-R-350
KTS-R-12	KTS-R-80	KTS-R-400
KTS-R-15	KTS-R-90	KTS-R-450
KTS-R-20	KTS-R-100	KTS-R-500
KTS-R-25	KTS-R-110	KTS-R-600

Carton Quantity and Weight

Ampere Ratings	Carton Qty.	Weight*	
		Lbs.	Kg.
1-30	10	1.45	0.657
40-60	10	2.63	1.262
70-100	1	0.5	0.226
110-200	1	1.4	0.634
225-400	1	2.75	1.246
450-600	1	4.25	1.925

*Weight per carton.

Time-Current and Current Limitation Curves located on page 226.



Recommended fuseblocks for Class R 600V fuses
See pages 50-52

CE logo denotes compliance with European Union Low Voltage Directive (50-1000Vac, 75-1500Vdc). Refer to Data Sheet: 8002 or contact Bussmann Application Engineering at 636-527-1270 for more information.



Data Sheet: 1043 (0-600)

Data Sheet: 1044 (0-600)

For complete specification data, call Bussmann Information Fax ~ 636.527.1450

One-Time General Purpose Fuses

NON and NOS

General Purpose Application

Non-Current Limiting

Ampere Ratings: 1/8-600A

Voltage Rating: NON: 250Vac, 125Vdc (0-100A);
NOS: 600Vac

Interrupting Rating: 50,000A RMS Sym. (0-60A),
10,000A RMS Sym. (65-600A), 50,000A @ 125Vdc
(NON 0-60),
10,000A @ 125Vdc (NON 65-100A)

Agency Information:

UL Listed – 250V: Class K5 (0-60A), Std. 248-9
Class H (65-600A), Std. 248-6
(125Vdc: NON 0-100)
600V: Class K5 (0-60A), Std. 248-9
Class H (70-600A), Std. 248-6

Guide JDDZ, File E4273

CSA Certified – 250V: (0-12, 65-600)†
600V: (0-600)

Class 1421-01, File 53787

Dimensions: See pages 2-3 for dimensional data under
Class RK5/RK1.

† For CSA Certified 15-60A Ratings, see PON Data Sheet 4126

Catalog Numbers (250Vac)

NON-1/8	NON-5	NON-40	NON-175
NON-1/4	NON-6	NON-45	NON-200
NON-3/8	NON-6 1/4	NON-50	NON-225
NON-1/2	NON-7	NON-60	NON-250
NON-1	NON-8	NON-65	NON-300
NON-1 1/4	NON-9	NON-70	NON-350
NON-1 1/2	NON-10	NON-75	NON-400
NON-1 3/4	NON-12	NON-80	NON-450
NON-2	NON-15	NON-90	NON-500
NON-2 1/2	NON-20	NON-100	NON-600
NON-3	NON-25	NON-110	—
NON-3 3/4	NON-30	NON-125	—
NON-4	NON-35	NON-150	—

Carton Quantity and Weight

Ampere Ratings	Carton Qty.	Weight*	
		Lbs.	Kg.
NON 1/8-30	10	0.38	0.172
NON 35-60	10	1.00	0.453
NON 65-100	5	0.79	0.358
NON 110-200	1	0.79	0.358
NON 225-400	1	1.65	0.748
NON 450-600	1	2.76	1.25

*Weight per carton.

Catalog Symbol & Current Ratings

Symbol	Rating	Class	Volt	IR
NON	0-60	K5	250ac	50,000
	65-600	H	250ac	10,000
	0-60	K5	125dc	50,000
	65-100	H	125dc	10,000
NOS	0-60	K5	600	50,000
	70-600	H	600	10,000



Recommended Fuse Reducers

250V				600V			
Clip Size	Fuse Size	Cat. No. (Pair)	Weight Carton* (lbs)	Clip Size	Fuse Size	Cat. No. (Pair)	Weight Carton* (lbs)
60A	30A	No. 263	0.38	60A	30A	No. 663	1.00
100A	30A	No. 213	1.73	100A	30A	No. 216	1.73
100A	60A	No. 216	1.73	100A	60A	No. 616	1.85
200A	60A	No. 226	3.00	200A	60A	No. 626	3.33
200A	100A	No. 2621	1.63	200A	100A	No. 2621	1.63
400A	100	No. 2641	4.90	400A	100	No. 2641	4.90
400A	200A	No. 2642	3.50	400A	200A	No. 2642	3.50
600A	100A	No. 2661	8.70	600A	100A	No. 2661	8.70
600A	200A	No. 2662	6.85	600A	200A	No. 2662	6.85
600A	400A	No. 2664	4.45	600A	400A	No. 2664	4.45

*Carton quantity—10 pair.

Catalog Numbers (600Vac)

NOS-1	NOS-12	NOS-70	NOS-200
NOS-2	NOS-15	NOS-75	NOS-225
NOS-3	NOS-20	NOS-80	NOS-250
NOS-4	NOS-25	NOS-90	NOS-300
NOS-5	NOS-30	NOS-100	NOS-350
NOS-6	NOS-35	NOS-110	NOS-400
NOS-7	NOS-40	NOS-125	NOS-450
NOS-8	NOS-45	NOS-150	NOS-500
NOS-9	NOS-50	NOS-175	NOS-600
NOS-10	NOS-60	—	—

Carton Quantity and Weight

Ampere Ratings	Carton Qty.	Weight*	
		Lbs.	Kg.
NOS 1-30	10	1.45	0.657
NOS 35-60	10	2.6	1.179
NOS 70-100	5	2.80	1.270
NOS 110-200	1	1.24	0.562
NOS 225-400	1	3.03	1.374
NOS 450-600	1	4.63	2.100

*Weight per carton.

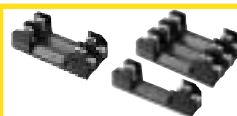

Recommended fuseblocks for Class H (K) 250 & 600V fuses
See pages 47-52

CE CE logo denotes compliance with European Union Low Voltage Directive (50-1000Vac, 75-1500Vdc). Refer to Data Sheet: 8002 or contact Bussmann Application Engineering at 636-527-1270 for more information.

Data Sheet: 1030



Low-Peak® Dual-Element, Time-Delay, Class J Fuses

LPJ_SP

**Dual-Element,
Time-Delay –**

10 seconds (minimum) at
500% rated current

Ampere Ratings:

1-600A

Voltage Rating:

600Vac (or less),
300Vdc (or less)

Current Limiting

Interrupting Rating:

ac – 300,000A RMS Sym. dc – 100,000A

Agency Information:

UL Listed - Special Purpose**, Guide JFHR, File E56412
CSA Certified (200,000 AIR) Class J per CSA-22.2 No. 248.8,
Class 1422-02, File 53787

Dimensions: See pages 2-3 for Class J dimensional data.

Catalog Numbers

LPJ-1SP	LPJ-4½SP	LPJ-25SP	LPJ-125SP
LPJ-1¼SP	LPJ-5SP	LPJ-30SP	LPJ-150SP
LPJ-1⅓SP	LPJ-5⅓SP	LPJ-35SP	LPJ-175SP
LPJ-1⅒SP	LPJ-6SP	LPJ-40SP	LPJ-200SP
LPJ-2SP	LPJ-7SP	LPJ-45SP	LPJ-225SP
LPJ-2¼SP	LPJ-8SP	LPJ-50SP	LPJ-250SP
LPJ-2½SP	LPJ-9SP	LPJ-60SP	LPJ-300SP
LPJ-2⅔SP	LPJ-10SP	LPJ-70SP	LPJ-350SP
LPJ-3SP	LPJ-12SP	LPJ-80SP	LPJ-400SP
LPJ-3⅓SP	LPJ-15SP	LPJ-90SP	LPJ-450SP
LPJ-3½SP	LPJ-17½SP	LPJ-100SP	LPJ-500SP
LPJ-4SP	LPJ-20SP	LPJ-110SP	LPJ-600SP

**Meets all performance requirements of UL Standard 248-8 for Class J fuses.
Available with silver plated terminals. Add SP/ in front of part number.

Carton Quantity and Weight

Ampere Ratings	Carton Qty.	Weight*	
		Lbs.	Kg.
0-30	10	1.09	0.49
35-60	10	1.78	0.81
70-100	5	1.69	0.77
110-200	5	4.21	1.91
225-400	1	1.67	0.76
450-600	1	2.80	0.27

*Weight per carton.



Recommended fuseblocks/fuseholders for Class J 600V fuses

- Open fuseblocks - see pages 53-55
- Finger-safe fuseholders for 30A & 60A - see pages 57-58
- Modular fuseblocks - see page 67

Time-Current Classification Curves—Average Melt

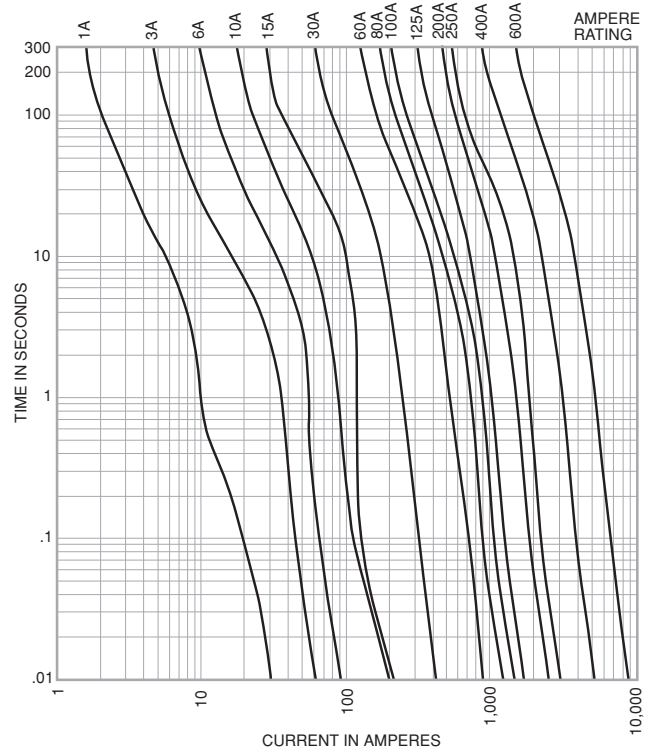

Current Limitation Curves

LPJ Current Limitation Curves

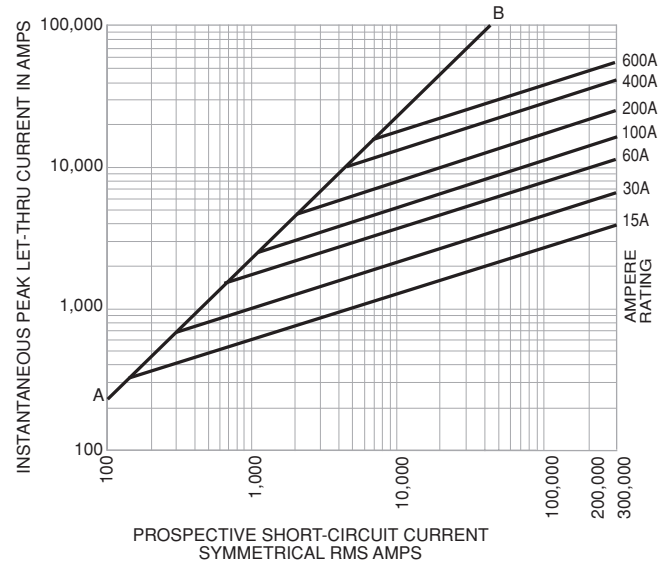

CE CE logo denotes compliance with European Union Low Voltage Directive (50-1000Vac, 75-1500Vdc). Refer to Data Sheet: 8002 or contact Bussmann Application Engineering at 636-527-1270 for more information.



Limitron® Quick Acting, Class J Fuses



JKS

Quick Acting

Ampere Ratings: 1-600A

Voltage Rating: 600Vac (or less)

Current Limiting

Interrupting Rating: 200,000A RMS Sym.

Agency Information: Std. 248-8, Class J

UL Listed, Guide JDDZ, File E4273

CSA Certified, Class 1422-02, File 53787

Dimensions: See pages 2-3 for Class J dimensional data.

Catalog Numbers

JKS-1	JKS-15	JKS-70	JKS-225
JKS-2	JKS-20	JKS-80	JKS-250
JKS-3	JKS-25	JKS-90	JKS-300
JKS-4	JKS-30	JKS-100	JKS-350
JKS-5	JKS-35	JKS-110	JKS-400
JKS-6	JKS-40	JKS-125	JKS-450
JKS-8	JKS-45	JKS-150	JKS-500
JKS-10	JKS-50	JKS-175	JKS-600
JKS-12	JKS-60	JKS-200	

Carton Quantity and Weight

Ampere Ratings	Carton Qty.	Weight*	
		Lbs.	Kg.
1-30	10	0.95	0.43
35-60	10	1.175	0.53
70-100	5	0.28	0.13
110-200	1	0.86	0.39
225-400	1	1.78	0.81
450-600	1	3.07	1.39

*Weight per carton.

CE CE logo denotes compliance with European Union Low Voltage Directive (50-1000Vac, 75-1500Vdc). Refer to Data Sheet: 8002 or contact Bussmann Application Engineering at 636-527-1270 for more information.

Recommended fuseblocks/fuseholders for Class J 600V fuses



- Open fuseblocks - see pages 53-55
- Finger-safe fuseholders for 30A & 60A- see pages 57-58
- Modular fuseblocks - see page 67

Fuse Reducers for J Dimension Fuses

Clip Size	Fuse Size	Cat. No. (Pair)	Weight Carton* (lbs)	Clip Size	Fuse Size	Cat. No. (Pair)	Weight Carton* (lbs)
60A	30A	J63	0.38	400A	100A	J41	4.90
100A	30A	J13	1.73	400A	200A	J42	2.75
100A	60A	J16	1.85	600A	400A	J64	3.55
200A	60A	J26	2.55	600A	200A	J62	3.55
200A	100A	J21	1.36	—	—	—	—

*Carton quantity—10 pair.

Data Sheet: 1026 (1-60A), 1027 (70-600A)



T-Tron® Very Fast Acting, Class T Fuses

JJN

Very Fast Acting

Ampere Ratings: 1-1200A

Voltage Rating: 300Vac (or less),
(15-600A 160Vdc; 601-1200 170Vdc)

Current Limiting

(curves on page 208)

Interrupting Rating: 200,000A RMS Sym.

(20,000A dc @ 160Vdc & 100,000A dc @ 170Vdc)

Agency Information: Std. 248-15, Class T

UL Listed, Guide JDDZ, File E4273

CSA Certified, Class 1422-02, File 53787

Dimensions: See pages 2-3 for Class T dimensional data.



Catalog Numbers

JJN-1	JJN-35	JJN-110	JJN-400
JJN-2	JJN-40	JJN-125	JJN-450
JJN-3	JJN-45	JJN-150	JJN-500
JJN-6	JJN-50	JJN-175	JJN-600
JJN-10	JJN-60	JJN-200	JJN-700
JJN-15	JJN-70	JJN-225	JJN-800
JJN-20	JJN-80	JJN-250	JJN-1000
JJN-25	JJN-90	JJN-300	JJN-1200
JJN-30	JJN-100	JJN-350	

Carton Quantity and Weight

Ampere Ratings	Carton Qty.	Weight*	
		Lbs.	Kg.
1-30	10	0.12	0.054
35-60	10	0.23	0.104
70-100	5	0.36	0.163
110-200	1	0.14	0.063
225-400	1	0.25	0.113
450-600	1	0.44	0.200
700-800	1	0.80	0.363
1000-1200	1	1.45	0.658

*Weight per carton.

CE CE logo denotes compliance with European Union Low Voltage Directive (50-1000 Vac, 75-1500Vdc). Refer to Data Sheet: 8002 or contact Bussmann Application Engineering at 636-527-1270 for more information.

Data Sheet: 1025



Recommended fuseblocks/fuseholders for Class T 300V fuses

- Open fuseblocks - see pages 59-60
- Modular fuseblocks - see page 67

JJS

Very Fast Acting

Ampere Ratings: 1-800A

Voltage Rating: 600Vac (or less)

Current Limiting (curves on

page 208)

Interrupting Rating: 200,000A

RMS Sym.

Agency Information: Std. 248-

15, Class T

UL Listed, Guide JDDZ, File E4273

CSA Certified, Class 1422-02, File 53787

Dimensions: See pages 2-3 for Class T dimensional data.



Catalog Numbers

JJS-1	JJS-30	JJS-90	JJS-250
JJS-2	JJS-35	JJS-100	JJS-300
JJS-3	JJS-40	JJS-110	JJS-350
JJS-6	JJS-45	JJS-125	JJS-400
JJS-10	JJS-50	JJS-150	JJS-450
JJS-15	JJS-60	JJS-175	JJS-500
JJS-20	JJS-70	JJS-200	JJS-600
JJS-25	JJS-80	JJS-225	JJS-800

Carton Quantity and Weight

Ampere Ratings	Carton Qty.	Weight*	
		Lbs.	Kg.
1-30	10	0.33	0.149
35-60	10	0.82	0.371
70-100	5	0.51	0.231
110-200	1	0.192	0.087
225-400	1	0.46	0.208
450-600	1	0.85	0.385
800	1	1.65	0.748

*Weight per carton.

CE CE logo denotes compliance with European Union Low Voltage Directive (50-1000Vac, 75-1500Vdc). Refer to Data Sheet: 8002 or contact Bussmann Application Engineering at 636-527-1270 for more information.

Data Sheet: 1029



Recommended fuseblocks/fuseholders for Class T 600V fuses

- Open fuseblocks - see pages 61-62
- Modular fuseblocks - see page 67



Time-Delay Class G Fuses



SC

Fast Acting (1/2-6A), Class G

Time-Delay (7-60A), Class G

Construction: Melamine Tube

Ampere Ratings: 1/2-60A

Voltage Rating: 1/2-20: 600Vac/170Vdc

25-60: 480Vac/300Vdc (only UL)

Interrupting Rating: 100,000A RMS Sym., 10,000A dc

Agency Information: Std. 248-5, Class G, UL Listed, Guide JDDZ, File E4273

CSA Certified, Class 1422-01, File 53787

Catalog Symbol & Current Ratings

SC-1/2	SC-6	SC-25
SC-1	SC-7	SC-30
SC-1 1/2	SC-8	SC-35
SC-2	SC-9	SC-40
SC-2 1/2	SC-10	SC-45
SC-3	SC-12	SC-50
SC-4	SC-15	SC-60
SC-5	SC-20	—

Carton Quantity and Weight

Ampere Ratings	Carton Qty.	Weight*	
		Lbs.	Kg.
1/2-15	4	0.06	0.03
20	4	0.06	0.03
25-30	2	0.04	0.02
35-60	2	0.08	0.03

*Weight per carton.

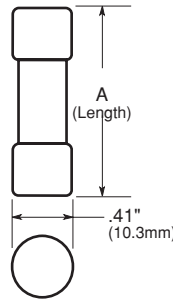

Physical Size:

Fuse (Amps) (Length)

SC-1/2 to -15	1.319
SC-20	1.419
SC-25 to -30	1.639
SC-35 to -60	2.259

- Compact branch-circuit units with high interrupting rating and current limitation.
- With a 600 volt rating, they can be used in 120/208, 120/240 and 277/480 volt circuits.
- Length variations relative to case size make the “rejection” type fuses.
- SC fuses with ampere ratings above 6 amps have a degree of overload time-delay which permits them to pass temporary overloads. At 200% load, they have a minimum opening time of 12 seconds.



Recommended fuseblocks/fuseholders for Class G

- Open fuseblocks - see page 64
- Panel-mount fuseholders - see page 78
- In-line fuseholders - see page 80

CE CE logo denotes compliance with European Union Low Voltage Directive (50-1000Vac, 75-1500Vdc). Refer to Data Sheet: 8002 or contact Bussmann Application Engineering at 636-527-1270 for more information.



Low-Peak® Time-Delay, Class CC Fuses



LP-CC Low-Peak® Fuse Time-Delay Current Limiting, Class CC - Rejection Type

Physical Size:

1 3/32" × 1 1/2"
(10.3mm × 38.1mm)

Ampere Ratings: 1/2 - 30A

Voltage Rating: 600Vac (or less), 300Vdc (1/2-2 9/10A & 20-30A), 150Vdc (3-15A)

Interrupting Rating: 200,000A RMS Sym; 20,000A dc

Construction: Melamine Tube

Agency Information: Std. 248-4, Class CC

UL Listed, Guide JDDZ, File E4273

CSA Certified; Class 1422-02, File 53787

Catalog Symbol

600Vac

LP-CC-1/2	LP-CC-2 1/2	LP-CC-7 1/2
LP-CC-9/10	LP-CC-2 9/10	LP-CC-8
LP-CC-9/10	LP-CC-3	LP-CC-9
LP-CC-1	LP-CC-3 9/10	LP-CC-10
LP-CC-1 1/8	LP-CC-3 1/2	LP-CC-12
LP-CC-1 1/4	LP-CC-4	LP-CC-15
LP-CC-1 1/10	LP-CC-4 1/2	LP-CC-20
LP-CC-1 1/2	LP-CC-5	LP-CC-25
LP-CC-1 9/10	LP-CC-5 9/10	LP-CC-30
LP-CC-1 9/10	LP-CC-6	
LP-CC-2	LP-CC-6 1/4	
LP-CC-2 1/4	LP-CC-7	



Recommended fuseblocks/fuseholders for Class CC 600V fuses

- Open fuseblocks - see page 64
- Finger-safe fuseholders - see pages 41-44, 65
- Panel-mount fuseholders - see page 78
- In-line fuseholders - see page 80

Time Current Characteristics—Average Melt

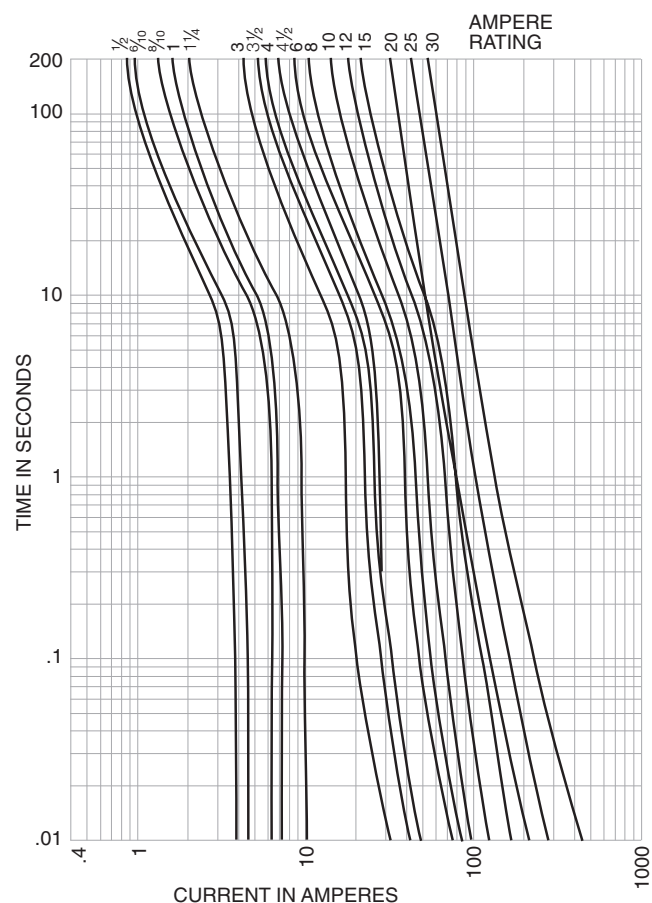

Current-Limiting Effects

Prospective Short-Circuit Current	*Let-Thru Current (Apparent RMS Symmetrical)					
	1 1/4A	2 9/10A	15A	20A	25A	30A
1000	100	135	240	305	380	435
3000	140	210	350	440	575	580
5000	165	255	420	570	690	710
10,000	210	340	540	700	870	1,000
20,000	260	435	680	870	1,090	1,305
30,000	290	525	800	1,030	1,300	1,520
40,000	315	610	870	1,150	1,390	1,700
50,000	340	650	915	1,215	1,520	1,820
60,000	350	735	1,050	1,300	1,650	1,980
80,000	390	785	1,130	1,500	1,780	2,180
100,000	420	830	1,210	1,600	2,000	2,400
200,000	525	1,100	1,600	2,000	2,520	3,050

*RMS Symmetrical Amperes Short-Circuit

NOTE: To calculate I_p (I_{peak}) multiply I_{RMS} value × 2.3.

CE CE logo denotes compliance with European Union Low Voltage Directive (50-1000Vac, 75-1500Vdc). Refer to Data Sheet: 8002 or contact Bussmann Application Engineering at 636-527-1270 for more information.



Class CC Rejection-Type Fuses



FNQ-R

**Time-Delay, Rejection Type
Branch Circuit Fuse
Class CC**

Physical Size:

$1\frac{3}{32}'' \times 1\frac{1}{2}''$ (10.3mm x 38.1mm)

Construction: Melamine Tube

Ampere Ratings: $\frac{1}{4}$ -30A.

Voltage Rating: 600Vac or less

Interrupting Rating: 200,000A RMS Sym.

Agency Information: Std. 248-4, Class CC

UL Listed, Guide JDDZ, File E4273

CSA Certified, Class 1422-01, File 53787

Catalog Symbol & Current Ratings

600Vac		
FNQ-R- $\frac{1}{4}$	FNQ-R-1 $\frac{1}{10}$	FNQ-R-7
FNQ-R- $\frac{3}{10}$	FNQ-R-1 $\frac{1}{10}$	FNQ-R-7 $\frac{1}{2}$
FNQ-R- $\frac{1}{2}$	FNQ-R-2	FNQ-R-8
FNQ-R- $\frac{1}{2}$	FNQ-R-2 $\frac{1}{4}$	FNQ-R-9
FNQ-R- $\frac{6}{10}$	FNQ-R-2 $\frac{1}{2}$	FNQ-R-10
FNQ-R- $\frac{3}{4}$	FNQ-R-2 $\frac{9}{10}$	FNQ-R-12
FNQ-R- $\frac{9}{10}$	FQN-R-3	FNQ-R-15
FNQ-R-1	FNQ-R-3 $\frac{3}{10}$	FNQ-R-17 $\frac{1}{2}$
FNQ-R-1 $\frac{1}{8}$	FNQ-R-3 $\frac{1}{20}$	FNQ-R-20
FNQ-R-1 $\frac{1}{4}$	FNQ-R-4	FNQ-R-25
FNQ-R-1 $\frac{3}{10}$	FNQ-R-5	FNQ-R-30
FNQ-R-1 $\frac{1}{10}$	FNQ-R-6	—
FNQ-R-1 $\frac{1}{2}$	FNQ-R-6 $\frac{1}{4}$	—

Time-Current Curves on page 225.

CE logo denotes compliance with European Union Low Voltage Directive (50-1000Vac, 75-1500Vdc). Refer to Data Sheet: 8002 or contact Bussmann Application Engineering at 636-527-1270 for more information.

Data Sheet: 1014



KTK-R Limitron® Fuse

**Fast Acting; Branch Circuit Fuse
Class CC - Rejection Feature**

Physical Size:

$1\frac{3}{32}'' \times 1\frac{1}{2}''$ (10.3mm x 38.1mm)

Construction: Melamine Tube

Ampere Ratings: $\frac{1}{10}$ -30A.

Voltage Rating: 600Vac (or less).

Interrupting Rating: 200,000A RMS Sym.

Agency Information: Std. 248-4, Class CC

UL Listed, Guide JDDZ, File E4273

CSA Certified, File 53787, Class 1422-02

Catalog Symbol & Current Ratings

600Vac		
KTK-R- $\frac{1}{10}$	KTK-R-1	KTK-R-7
KTK-R- $\frac{1}{8}$	KTK-R-1 $\frac{1}{2}$	KTK-R-8
KTK-R- $\frac{3}{10}$	KTK-R-2	KTK-R-9
KTK-R- $\frac{1}{4}$	KTK-R-2 $\frac{1}{2}$	KTK-R-10
KTK-R- $\frac{3}{10}$	KTK-R-3	KTK-R-12
KTK-R- $\frac{1}{10}$	KTK-R-3 $\frac{1}{2}$	KTK-R-15
KTK-R- $\frac{1}{2}$	KTK-R-4	KTK-R-20
KTK-R- $\frac{9}{10}$	KTK-R-5	KTK-R-25
KTK-R- $\frac{3}{4}$	KTK-R-6	KTK-R-30

Time-Current Curves on page 226.

CE logo denotes compliance with European Union Low Voltage Directive (50-1000Vac, 75-1500Vdc). Refer to Data Sheet: 8002 or contact Bussmann Application Engineering at 636-527-1270 for more information.

Data Sheet: 1015



Recommended fuseblocks/fuseholders for Class CC 600V fuses

- Open fuseblocks - see page 64
- Finger-safe fuseholders - see pages 41-44, 65
- Panel-mount fuseholders - see page 78
- In-line fuseholders - see page 80



1 3/32" x 1 3/8" Supplementary Fuses



BBS

Fast Acting

Physical Size:

1 3/32" x 1 3/8" (10.3mm x 35mm)

Construction: Fibre Cartridge

Interrupting Rating: 10,000A RMS Sym.

Ampere Ratings: 1/10-30A

Voltage Rating: 600Vac (1/10-5A), 250Vac (6-10A), 48Vac (12-30A)

Agency Information: Std. 248-14

UL Listed, 0-5A/600V, Guide JDYX, File E19180

CSA Certified, 0-5A/600V, Class 1422-01, File 53787

Catalog Symbol & Current Ratings

600Vac	250Vac	48Vac
BBS-1/10	BBS-6	BBS-12
BBS-2/10	BBS-7	BBS-15
BBS-3/4	BBS-8	BBS-20
BBS-4/10	BBS-10	BBS-25
BBS-1/2	—	BBS-30
BBS-5/10	—	—
BBS-3/4	—	—
BBS-8/10	—	—
BBS-1	—	—
BBS-1 1/2	—	—
BBS-1 3/10	—	—
BBS-1 5/10	—	—
BBS-2	—	—
BBS-3	—	—
BBS-4	—	—
BBS-5	—	—

Data Sheet: 2010 (0-30A)

CE CE logo denotes compliance with European Union Low Voltage Directive (50-1000Vac, 75-1500Vdc). Refer to Data Sheet: 8002 or contact Bussmann Application Engineering at 636-527-1270 for more information.



KTQ

Fast Acting

Physical Size:

1 3/32" x 1 3/8" (10.3mm x 34.9mm)

Construction: Fibre Cartridge

Ampere Ratings: 1-6A

Voltage Rating: 600Vac

Interrupting Rating: 10,000A RMS Sym.

Agency Information: Std. 248-14

UL Recognized, 4-6A, Guide JDYX2, File E19180

Catalog Symbol & Current Ratings

600Vac
KTQ-1
KTQ-1 1/10
KTQ-2
KTQ-3
KTQ-4
KTQ-5
KTQ-6

Data Sheet: 2045

CE CE logo denotes compliance with European Union Low Voltage Directive (50-1000Vac, 75-1500Vdc). Refer to Data Sheet: 8002 or contact Bussmann Application Engineering at 636-527-1270 for more information.



Recommended fuseblocks/fuseholders for 1 3/32" x 1-1/2" fuses

- Open fuseblocks - see page 64, 66
- Finger-safe fuseholders - see pages 41-44, 65
- Panel-mount fuseholders - see page 78-79
- In-line fuseholders - see page 80-81



1 3/32" x 1 1/2" Supplementary Fuses



BAF

Fast Acting

Physical Size:

1 3/32" x 1 1/2"
(10.3mm x 38.1mm)

Construction: Fibre Tube;
Nickel Plated Brass Endcaps

Voltage Rating: 250Vac (1/10-15A),
125Vac (20-30A)

Interrupting Rating: 10,000A at
125Vac

Agency Information: Std. 248-14
UL 0-15/250V, Guide JDYX,
File E19180

CSA Certified, 0-15/250V,
Class 1422-01, File 53787

Catalog Symbol & Current Ratings

250V IR*	250V IR*	250V IR*	125V
BAF-1/10	BAF-1 1/2	BAF-6 1/4	BAF-20
BAF-1/4	BAF-1 1/10	BAF-7	BAF-25 IR
BAF-1/2	BAF-2 IR	BAF-8 200A	BAF-30 10000A
BAF-3/10	BAF-2 1/2	BAF-9	—
BAF-3/10	BAF-3	BAF-10	—
BAF-1	BAF-4	BAF-12 IR	—
—	BAF-5 IR	BAF-15 750A	—
—	BAF-6	—	—

*All have interrupting rating of 10,000A at 125V.

Data Sheet: 2011 (0-30)

CE CE logo denotes compliance with European Union Low Voltage Directive (50-1000Vac, 75-1500Vdc). Refer to Data Sheet: 8002 or contact Bussmann Application Engineering at 636-527-1270 for more information.



BAN

Fast Acting

Physical Size:

1 3/32" x 1 1/2"
(10.3mm x 38.1mm) - 5AG

Construction: Fibre Tube

Voltage Rating: 250Vac

Interrupting Ratings: Military Tested

35A (1.1-.3.5A)

100A (3.6-10A)

200A (10.1-15A)

750A (15.1-30A)

Catalog Symbol & Current Ratings

250V	250V	250V	250V
BAN-1	BAN-5	BAN-12	BAN-30
BAN-2	BAN-6	BAN-15	—
BAN-3	BAN-8	BAN-20	—
BAN-4	BAN-10	BAN-25	—

Recommended Fuseblocks

Amps	Poles	Terminal Type		
		Screw with Quick Connect	Pressure Plate w/ Quick Connect	Box Lug
1/10 to 30	1	BM6031SQ	BM6031PQ	BM6031B
	2	BM6032SQ	BM6032PQ	BM6032B
	3	BM6033SQ	BM6033PQ	BM6033B

Data Sheet: 2046 (0-30)



KTK and KLM

Fast Acting

Physical Size:

1 3/32" x 1 1/2" (10.3mm x 38.1mm)

Construction: Melamine Tube;
Nickel Plated Brass Endcaps

Voltage Rating:

KTK - 600Vac or less

KLM - 1/10-1/8A: 500Vac/600Vdc

2/10-10A: 500Vac/dc,

12-30A: 500Vac/600Vdc

Interrupting Rating:

100,000A - KTK; 10,000A - KLM,
RMS SYM. (UL)

Agency Information: Std. 248-14

KTK-UL Listed, Guide JDYX,

File E19180

KLM-UL Recognized, Guide JFHR2,

File E56412

CSA Certified, File 53787, Class

1422-01, HRC-Misc

Catalog Symbol & Current Ratings

600Vac - UL Listed and C.S.A.

KTK-1/10	KTK-3/4	KTK-4	KTK-12
KTK-1/8	KTK-1	KTK-5	KTK-15
KTK-2/10	KTK-1 1/4	KTK-6	KTK-20
KTK-1/4	KTK-1 1/2	KTK-7	KTK-25
KTK-3/10	KTK-2	KTK-7 1/2	KTK-30
KTK-1/2	KTK-2 1/2	KTK-8	—
KTK-1/2	KTK-3	KTK-9	—
KTK-3/10	KTK-3 1/2	KTK-10	—
*500Vac/dc - UL Recognized and C.S.A.			
KLM-1/10	KLM-3/4	KLM-5	KLM-20
KLM-1/8	KLM-1	KLM-6	KLM-25
KLM-2/10	KLM-1 1/2	KLM-8	KLM-30
KLM-1/4	KLM-2	KLM-10	—
KLM-3/10	KLM-3	KLM-12	—
KLM-1/2	KLM-4	KLM-15	—

*KLM-(1/10-1/8 & 12-30): 500VAC/600Vdc

CE CE logo denotes compliance with European Union Low Voltage Directive (50-1000Vac, 75-1500Vdc). Refer to Data Sheet: 8002 or contact Bussmann Application Engineering at 636-527-1270 for more information.

Data Sheet: KTK-1011

KLM-2020





Recommended fuseblocks/fuseholders for 13/32" x 1-1/2" fuses

- Open fuseblocks - see page 64, 66
- Finger-safe fuseholders - see pages 41-44, 65
- Panel-mount fuseholders - see page 78-79
- In-line fuseholders - see page 80-81

13/32" x 1 1/2" Supplementary Fuses



FNM Fusetron® Fuse

Time-Delay

Physical Size: 13/32" x 1 1/2" (5 AG)

(10.3mm x 38.1mm)

Construction: Fibre Tube

Ampere Ratings: 1/10 - 30A.

Voltage Rating: 250Vac (or less).

Interrupting Rating: See Table Below.

Agency Information: Std. 248-14

UL Listed, 0-10/250V; 12-15/125V;

File E19180, Guide JDYX

CSA Certified, 1-10/250V; Class 1422-01, 12-15/125V;

File 53787

NOTE: For 250V applications from 12-30A use FNW.

Catalog Symbol & Current Ratings

250Vac	IR	250Vac	IR
FNM-1/10		FNM-1 1/8	
FNM-1/8		FNM-1 1/4	
FNM-3/100		FNM-1 9/10	
FNM-2/10		FNM-1 1/2	
FNM-1/4		FNM-1 9/10	100A
FNM-3/10	35A	FNM-1 9/10	@ 250Vac
FNM-1/2	@ 250Vac	FNM-2	10,000A
FNM-9/10	@ 125Vac	FNM-2 1/4	@ 125Vac
FNM-3/4		FNM-2 1/2	
FNM-9/10		FNM-2 9/10	
FNM-1		FNM-3	
—		FNM-3 7/10	
—		FNM-3 1/2	

250Vac	IR	125Vac	IR
FNM-4		FNM-12	
FNM-4 1/2		FNM-15	10,000A
FNM-5		—	@ 125Vac
FNM-5 9/10		—	
FNM-6	200A	32Vac	
FNM-6 1/4	@ 250Vac	FNM-20	
FNM-7	10,000A	FNM-25	
FNM-8	@ 125Vac	FNM-30	
FNM-9		—	
FNM-10		—	

CE CE logo denotes compliance with European Union Low Voltage Directive (50-1000Vac, 75-1500Vdc). Refer to Data Sheet: 8002 or contact Bussmann Application Engineering at 636-527-1270 for more information.



FNQ

Time-Delay

Physical Size:

13/32" x 1 1/2" (5 AG)

(10.3mm x 38.1mm)

Construction: Fibre Tube

Ampere Ratings: 1/10 - 30A

Voltage Rating: 500Vac or less

Interrupting Rating: 10,000A RMS Sym.

Agency Information: Std. 248-14

UL Listed, Guide JDYX, File E19180

CSA Certified, Class 1422-01, File 53787

Catalog Symbol & Current Ratings

500Vac			
FNQ-1/10	FNQ-9/10	FNQ-3 3/10	FNQ-8
FNQ-1/8	FNQ-1	FNQ-3 1/2	FNQ-9
FNQ-1 9/100	FNQ-1 1/8	FNQ-4	FNQ-10
FNQ-3/16	FNQ-1 1/4	FNQ-4 1/2	FNQ-12
FNQ-3/10	FNQ-1 1/2	FNQ-5	FNQ-14
FNQ-1/4	FNQ-1 9/10	FNQ-5 9/10	FNQ-15
FNQ-3/10	FNQ-2	FNQ-6	FNQ-20
FNQ-4/10	FNQ-2 1/4	FNQ-6 1/4	FNQ-25
FNQ-1/2	FNQ-2 1/2	FNQ-7	FNQ-30
FNQ-6/10	FNQ-3	—	—

Data Sheet: 1012

CE CE logo denotes compliance with European Union Low Voltage Directive (50-1000Vac, 75-1500Vdc). Refer to Data Sheet: 8002 or contact Bussmann Application Engineering at 636-527-1270 for more information.



Recommended fuseblocks/fuseholders for 13/32" x 1-1/2" fuses

- Open fuseblocks - see page 64, 66
- Finger-safe fuseholders - see pages 41-44, 65
- Panel-mount fuseholders - see page 78-79
- In-line fuseholders - see page 80-81



Data Sheet: 2028

For complete specification data, call Bussmann Information Fax ~ 636.527.1450

Plug Fuses



W Series

Fast Acting

Ampere Ratings: 1/2 - 12A

Voltage Rating: 125Vac

IR: 10,000A RMS Sym.

Element is a simple fusible, metal link. For general purpose circuit protection. Quickly opens when short-circuit or overload occurs. Use for lighting and other non-motor circuits. Edison base.

Agency Information: Std. 248-11
UL Listed, Guide JEFV, File E12112

Type W

W-1/2	W-4	W-10
W-1	W-5	W-12
W-1 8/10	W-6	
W-2	W-6 1/2	
W-2 1/2	W-7	
W-3	W-8	

CE logo denotes compliance with European Union Low Voltage Directive (50-1000Vac, 75-1500Vdc). Refer to Data Sheet: 8002 or contact Bussmann Application Engineering at 636-527-1270 for more information.



SL and TL Series

Time-Delay, Loaded Link

Ampere Ratings: 15 - 30A

Voltage Rating: 125Vac

IR: 10,000A RMS Sym.

Heat absorbing metal bead on element link for time-delay. Passes motor overload starting currents without needlessly opening.

Edison base (TL), Rejection base (SL).

Agency Information: Std. 248-11
UL Listed, Guide JEFV, File E12112

Type SL

Type TL

SL-15	TL-15
SL-20	TL-20
SL-25	TL-25
SL-30	TL-30

CE logo denotes compliance with European Union Low Voltage Directive (50-1000Vac, 75-1500Vdc). Refer to Data Sheet: 8002 or contact Bussmann Application Engineering at 636-527-1270 for more information.

Data Sheet: 1033 (SL) & 1035 (TL)



S and T Series

Time-Delay, Dual-Element

Ampere Ratings:

Type S: 1/4 - 30A

Type T: 3/10 - 30A

Voltage Rating: 125Vac

IR: 10,000A RMS Sym.

For all-purpose application. Like two fuses in one. A simple link element for short-circuits and dangerous overloads plus a series-connected element which lets the harmless overload starting currents of motors pass without opening. Uses less energy; operates cooler; provides superior protection.

Edison base (T), Rejection base (S).

Agency Information: Std. 248-11

Type S: UL Listed (0-6 1/4) Guide JFHR, File E56412 (7-30A) Guide JEFV, File E12112;

CSA Certified, Class 1423-01, File 53787

Type S

S-1/4	S-1 1/10	S-3 1/2	S-9
S-3/10	S-1 6/10	S-4	S-10
S-4/10	S-1 8/10	S-4 1/2	S-12
S-1/2	S-2	S-5	S-14
S-6/10	S-2 1/4	S-5 5/10	S-15
S-8/10	S-2 1/2	S-6	S-20
S-1	S-2 8/10	S-6 1/4	S-25
S-1 1/8	S-3	S-7	S-30
S-1 1/4	S-3 2/10	S-8	

Type T

T-3/10	T-1 6/10	T-4	T-10
T-4/10	T-1 8/10	T-4 1/2	T-12
T-1/2	T-2	T-5	T-14
T-6/10	T-2 1/4	T-5 5/10	T-15
T-8/10	T-2 1/2	T-6	T-20
T-1	T-2 8/10	T-6 1/4	T-25
T-1 1/8	T-3	T-7	T-30
T-1 1/4	T-3 2/10	T-8	
T-1 3/10	T-3 1/2	T-9	

CE logo denotes compliance with European Union Low Voltage Directive (50-1000Vac, 75-1500Vdc). Refer to Data Sheet: 8002 or contact Bussmann Application Engineering at 636-527-1270 for more information.

Data Sheet: 1032 (S) & 1034 (T)

Data Sheet: 1036



Plug Fuses



Fustat Fuse Adaptors

Fustat Adaptors (various ampere ratings) screw into the "Edison" Thread fuse sockets of standard household fuse boxes. Adaptors serve the purpose of preventing the wrong size fuse from being used.

Catalog Number Prefix	Ampere Rating	Carton	
		Qty.	Wt.
SA- (Branch Circuits)	15, 20, 30	4	0.03 (lbs)
SA- (Single Motor Circuits)	1, 1¼, 1⅞, 2, 2½, 3⅞, 4, 5, 6¼, 8, 10		
ENA	Edison base neutral		

Dual-Element Fustat® Fuses and Adaptors for Small Motor Protection.

(Both Motor Running and Short-Circuit Protection)

Adaptor	Accepts Fuses
SA-1	S-1 or smaller
SA-1-1/4	S-1-1/4 or smaller
SA-1-6/10	S-1-6/10 or smaller
SA-2	S-2 or S-1-8/10
SA-2-1/2	S-2-1/2 to S-1-8/10
SA-3-2/10	S-3-2/10 to S-1-8/10
SA-4	S-4 to S-3-1/2
SA-5	S-5 to S-3-1/2
SA-6-1/4	S-6-1/4 to S-3-1/2
SA-8	S-8 to S-7
SA-10	S-10 to S-7
SA-15	S-15 to S-7
SA-20	S-20
SA-30	S-30 to S-20

Branch Circuit Protection

Adaptor	Accepts Fuses
SA-15	S-15 to S-7
SA-20	S-20
SA-30	S-25
SA 30	S-30 to S-20



Cable Limiters & Welder Limiters



K Series

Cable Limiters

Interrupting Rating: 200,000A, 600Vac
RMS Symmetrical

UL Listing: KDM, KDR, KDP and KFM

Copper Cable Limiter — 600 Volts

Catalog Symbol	Cable Size	Catalog Symbol	Cable Size
Tubular Terminals			
KCY	#4	KCF	4/0
KCZ	#3	KCH	250 MCM
KCA	#2	††K CJ	350 MCM
KCB	#1	†† †KCM	500 MCM
KCC	1/0	KCV	600 MCM
††KCD	2/0	††KCR	750 MCM
KCE	3/0	KCS	1000 MCM
Tubular Terminal and Offset Bolt-Type Terminal			
KQV	#12	KDD	2/0
KQT	#10	KDE	3/0
KFZ	#8	KDF	4/0
KIG	#6	KDH	250 MCM
KDY	#4	††KDJ	350 MCM
KDA	#2	†KDM ¹	500 MCM
KDB	#1	KDU	600 MCM
KDC	1/0	††KDR ¹	750 MCM
Compression Connector Rod Terminal and Tubular Terminal			
KEX	4/0	KQO	350 MCM
KFH-A	250 MCM	††KDT	500 MCM
*Center Bolt-Type Terminal and Off-Set Bolt-Type Terminal			
KPF	4/0	KDP ¹	500 MCM
KFT	250 MCM	KFM ¹	750 MCM
KEW	350 MCM		

†Available with molded rubber boots. Add “-B” to end of part number.

††Available with shrink tube “_V” suffix.

¹Copper or aluminum cable; sizes of all other limiters pertain to copper only.

UL Listed (File E90818)

- Crimp Tool: TBM-14M
- Die: 15506 KDM
15515 KDR

Data Sheet: 1042



68000 & 64000 Series

Welder Limiters for Class H and J Fuseholders

Voltage Rating: 600Vac or less

Interrupting Rating: 200,000 Amps RMS Symmetrical

Catalog Symbol & Current Ratings

Type Fuseholder	Catalog Number	Amp Rating (Nominal)	Carton Quantity	Weight Each Lbs.	Weight Each Kg.
Class H	68150	150	1	1.40	0.63
	68200	200			
	68300	300	1	2.75	1.25
	68400	400			
	68600	600	1	4.25	1.92
Class J	64200	200	1	1.00	0.45
	64300	300	1	1.75	0.79
	64400	400	1	1.75	0.79
	64600	600	1	3.50	1.59

- Current-limiting devices designed specially for use on welder circuits only.
- Time-current characteristics are designed to hold on the intermittent overloading encountered in welder operation, while providing short-circuit protection to the circuit and equipment.
- Welder limiters have excess current capacity in the operating range as needed for this type of service.
- Because of the special characteristics of the welder limiters, they are not intended for application on general-use circuits.

Data Sheet: 1045



5mm × 15mm Fuses



C515 (Axial Leads) C519

Time-Delay

Physical Size:

0.197" × 0.591" (5mm × 15mm)

Construction: Glass Tube

Agency Information:

UL Listing File E19180, Guide JDYX

125mA-250mA and 375mA-3A

CSA Certification File LR65063,

Class 1422-01, 125mA-250mA and

375mA-3A

UL Recognized, File E19180,

Guide JDYX2, 350mA and 3.5A-7A

CE CE logo denotes compliance with European Union Low Voltage Directive (50-1000Vac, 75-1500Vdc). Refer to Data Sheet: 8002 or contact Bussmann Application Engineering at 636-527-1270 for more information.

Electrical Characteristics

Current Rating	Rated Voltage ac	Interrupting Rating
125mA	250V	35A/250V 10kA/125V p.f. = 0.7 - 0.8
250mA		35A/250V 10kA/125V 25A/600V p.f. = 0.7 - 0.8
350mA		
375mA		35A/250V 10kA/125V p.f. = 0.7 - 0.8
500mA		
600mA		
750mA		
1A		100A/250V 10kA/125V p.f. = 0.7 - 0.8
1.25A		
1.5A		
1.6A		
2A		
2.25A		
2.5A	125V	400A/125V p.f. = 1.0
3A		
3.5A		
4A		
5A		
7A		

Data Sheet: 2006 (C515)
& 2007 (C519)



C518 (Axial Leads) C520

Fast-Acting

Physical Size:

0.197" × 0.591" (5mm × 15mm)

Construction: Glass Tube

Agency Information:

UL Listing File E19180, Guide JDYX

CSA Certification File LR65063,

Class 1422-01

CE CE logo denotes compliance with European Union Low Voltage Directive (50-1000Vac, 75-1500Vdc). Refer to Data Sheet: 8002 or contact Bussmann Application Engineering at 636-527-1270 for more information.

Electrical Characteristics

Current Rating	Rated Voltage dc	Interrupting Rating
100mA	250V	35A/250V 10kA/125V p.f. = 0.7 - 0.8
125mA		
250mA		
375mA		
500mA		
750mA		100A/250V 10kA/125V p.f. = 0.7 - 0.8
1A		
1.5A		
2A		
2.5A		
3A		200A/250V 10kA/125V5A p.f. = 0.7 - 0.8
3.5A		
4A		
5A		

Data Sheet: 2026 (C518)
& 2027 (C520)



C517 (Axial Leads) Fast-Acting, Light Ballast Protection

Physical Size:

0.197" × 0.591" (5mm × 15mm)

Construction: Ceramic

Agency Information:

UL Listing File E19180, Guide JDYX

CSA Certification File LR65063,

Class 1422-01

UL Recognized, File E19180,

Guide JDYX2

CE CE logo denotes compliance with European Union Low Voltage Directive (50-1000Vac, 75-1500Vdc). Refer to Data Sheet: 8002 or contact Bussmann Application Engineering at 636-527-1270 for more information.

Electrical Characteristics

Current Rating	Max. Rated Voltage ac	Interrupting Rating
3A	350V*	100A/350Vac p.f. = 1.0
		100A/250Vac p.f. = 0.7 - 0.8
		10kA/125Vac p.f. = 0.7 - 0.8

*350Vac/100A is UL Recognized

Data Sheet: 2025



5mm × 20mm — IEC Standards

GDA GDA-V (Axial Leads)

**Fast-Acting,
High Breaking
Capacity**

Physical Size:
0.197" × 0.788"
(5mm × 20mm)

Construction:
Ceramic Tube

End caps: Nickel plated brass

Voltage Rating: 250Vac or less

Interrupting Rating: 1500A @
250Vac

Agency Information:

UL Recognized, Guide JDYX2,

File E19180, 50mA and 315mA-6.3A

SEMKO Approval 50mA, 200mA and
315mA-6.3A

IEC 127-SI

VDE Approval 1.25A-6.3A



GDB GDB-V (Axial Leads)

**Fast-Acting,
Low Breaking
Capacity**

Physical Size:
0.197" × 0.788"
(5mm × 20mm)

Construction:
Glass Tube

End caps: Nickel plated brass

Voltage Rating: 250Vac or less

Interrupting Rating: 35A @ 250Vac

Agency Information:

Designed to IEC (Pub 127) Sheet II

British Standard Approval

SEMKO Approval

VDE Approval, IMQ

UL Recognized, Guide JDYX2,

File E19180, 32mA-6.3A



GDC GDC-V (Axial Leads)

**Time Delay,
Low Breaking
Capacity**

Physical Size:
0.197" × 0.788"
(5mm × 20mm)

Construction:
Glass Tube

End caps: Nickel plated brass

Voltage Rating: 250Vac or less

Interrupting Rating: 35A @ 250Vac

Agency Information:

Designed to IEC (Pub 127) Sheet III

British Standard Approval

SEMKO Approval

VDE Approval, IMQ

UL Recognized, Guide JDYX2,

File E19180, 32mA-6.3A



CE CE logo denotes compliance with European Union Low Voltage Directive (50-1000Vac, 75-1500Vdc). Refer to Data Sheet: 8002 or contact Bussmann Application Engineering at 636-527-1270 for more information.

CE CE logo denotes compliance with European Union Low Voltage Directive (50-1000Vac, 75-1500Vdc). Refer to Data Sheet: 8002 or contact Bussmann Application Engineering at 636-527-1270 for more information.

CE CE logo denotes compliance with European Union Low Voltage Directive (50-1000Vac, 75-1500Vdc). Refer to Data Sheet: 8002 or contact Bussmann Application Engineering at 636-527-1270 for more information.

Electrical Characteristics

Current Rating	I ² t	Max Voltage Drop (mV)
50mA	0.0017	9000
63mA	0.0005	3300
80mA	0.0011	2600
100mA	0.0018	2300
125mA	0.0037	1900
160mA	0.008	1600
200mA	0.020	1350
250mA	0.027	1300
315mA	0.010	1400
400mA	0.018	1200
500mA	0.038	1050
630mA	0.064	1200
800mA	0.097	490
1A	0.480	230
1.25A	0.9	200
1.6A	1.9	180
2A	2.0	205
2.5A	3.9	190
3.15A	8.1	160
4A	14	160
5A	25	155
6.3A	48	150

Electrical Characteristics

Current Rating	I ² t*	Max Voltage Drop (mV)
32mA	0.000047	10000
40mA	0.00011	8000
50mA	0.00020	3200
63mA	0.00057	2500
80mA	0.0012	2200
100mA	0.003	2100
125mA	0.005	2000
160mA	0.008	1950
200mA	0.016	1600
250mA	0.028	1400
315mA	0.058	1150
400mA	0.018	950
500mA	0.018	220
630mA	0.035	220
800mA	0.067	180
1A	0.60	200
1.25A	0.84	200
1.6A	1.6	190
2A	4.2	160
2.5A	6.1	145
3.15A	13	130
4A	22	120
5A	42	115
6.3A	69	110
8A*	—	—
10A*	—	—
12A*	—	—
16A*	—	—

*IEC Standard 127 Sheet II does not include ratings above 6.3A.

Electrical Characteristics

Current Rating	I ² t	Max Voltage Drop (mV)
32mA	0.0014	1050
40mA	0.0034	920
50mA	0.006	800
63mA	0.012	760
80mA	0.015	580
100mA	0.022	490
125mA	0.034	390
160mA	0.052	320
200mA	0.078	340
250mA	0.17	270
315mA	0.41	250
400mA	0.61	210
500mA	0.75	168
630mA	1.3	158
800mA	3.1	132
1A	3.6	85
1.25A	7	80
1.6A	10	80
2A	17	80
2.5A	34	80
3.15A	56	75
4A	91	75
5A	133	75
6.3A	270	65

Data Sheet: 2014

Data Sheet: 2015

Data Sheet: 2016



5mm × 20mm – N. American Standards

GMA GMA-V (Axial Leads)

Fast Acting

Physical Size:

0.197" × 0.788"

(5mm × 20mm)

Construction:

Glass Tube
End Caps; nickel plated brass

Agency

Information:

Std. 248-14

UL Listed Guide JDYX, File E19180, 0-6A

UL Recognized, Guide JDYX2,

File E19180, 7-15A

CSA Certified, Class 1422-01,

File E65063, 0-6A



CE logo denotes compliance with European Union Low Voltage Directive (50-1000Vac, 75-1500Vdc). Refer to Data Sheet: 8002 or contact Bussmann Application Engineering at 636-527-1270 for more information.

Electrical Characteristics

Current Rating	Rated Voltage (Vac)	Breaking Capacity
63mA 100mA 125mA 200mA 250mA 300mA 315mA 500mA 600mA 750mA 800mA 1A 1.25A 1.5A 1.6A 2A 2.5A 3.15A 3.5A 4A 5A 6A 7A 8A 10A 15A	250	35A/250V 10kA/125V p.f. = 0.7 – 0.8
	125	100A/250V 10kA/125V p.f. = 0.7 – 0.8
		10kA/125V p.f. = 0.7 – 0.8
		200A/125V p.f. = 1.0
		150A/125V p.f. = 1.0

Data Sheet: 2017

GMC GMC-V (Axial Leads)

Medium Time-Delay

Physical Size:

0.197" × 0.788"

(5mm × 20mm)

Construction:

Glass Tube
End Caps; nickel plated brass

Agency Information:

Std. 248-14

UL Listed Guide JDYX, File E19180, 0-

6.3A

UL Recognized, Guide JDYX2,

File E19180, 7-8A

CSA Certified, Class 1422-01,

File 65063, 0-6.3A



CE logo denotes compliance with European Union Low Voltage Directive (50-1000Vac, 75-1500Vdc). Refer to Data Sheet: 8002 or contact Bussmann Application Engineering at 636-527-1270 for more information.

Electrical Characteristics

Current Rating	Rated Voltage (Vac)	Breaking Capacity
63mA 80mA 100mA 125mA 150mA 200mA 250mA 300mA 315mA 400mA 500mA 600mA 630mA 750mA 800mA 1A 1.25A 1.5A 1.6A 2A 2.5A 3A 3.15A 3.5A 4A 5A 6A 6.3A 7A 8A 10A	250	35A/250V 10kA/125V p.f. = 0.7 – 0.8
	125	100A/250V 10kA/125V p.f. = 0.7 – 0.8
		10kA/125V p.f. = 0.7 – 0.8
		200A/125V p.f. = 1.0

Data Sheet: 2018

GMD GMD-V (Axial Leads)

Time-Delay

Physical Size:

0.197" × 0.788"

(5mm × 20mm)

Construction:

Glass Tube
End Caps; nickel plated brass

Agency

Information:

Std. 248-14

UL Listed Guide JDYX, File E19180, 0-3A

UL Recognized, Guide JDYX2,

File E19180, 4A

CSA Certified, Class 1422-01,

File 65063, 0-3A



CE logo denotes compliance with European Union Low Voltage Directive (50-1000Vac, 75-1500Vdc). Refer to Data Sheet: 8002 or contact Bussmann Application Engineering at 636-527-1270 for more information.

Electrical Characteristics

Current Rating	Rated Voltage (Vac)	Breaking Capacity
125mA 150mA 200mA 250mA 300mA 315mA 400mA 500mA 600mA 630mA 750mA 800mA 1A 1.2A 1.25A 1.5A 1.6A 2A 2.5A 3A 4A	250	100A/250V 10kA/125V p.f. = 0.7 – 0.8
	125	200A/250V 10kA/125V, p.f. = 1

Data Sheet: 2019



1/4" Diameter x 5/8" to 1" Lengths



AGA AGA-V* (Axial Leads)

Fast Acting

Physical Size:

1/4" x 5/8" (1AG)
(6.4mm x 15.9mm)

Construction: Glass Tube

Voltage Rating: See table below.

Agency Information: Std. 248-14

UL File E19180,

UL Listed, Guide JDYX 0-1 1/2A

UL Recognized, Guide JDYX2 2-12A,

CE CE logo denotes compliance with European Union Low Voltage Directive (50-1000Vac, 75-1500Vdc). Refer to Data Sheet: 8002 or contact Bussmann Application Engineering at 636-527-1270 for more information.

Catalog Symbol & Current Ratings

125Vac/10kA (1/16-1 1/2), 200A (2-5A)

AGA-1/16	AGA-1/2	AGA-2
AGA-1/10	AGA-9/10	AGA-2 1/2
AGA-1/8	AGA-3/4	AGA-3
AGA-1/4	AGA-1	AGA-5
AGA-3/8	AGA-1 1/2	—
32Vac/1kA		
AGA-6	AGA-10	AGA-25
AGA-7	AGA-15	AGA-30
AGA-7 1/2	AGA-20	—

*AGA-V is UL Listed 0-5A, UL Recognized 6-12A

Data Sheet: 2039



AGW

Fast Acting

Physical Size:

1/4" x 7/8" (7AG)
(6.4mm x 22.2mm)

Construction: Glass Tube

Voltage Rating: 32V

Catalog Symbol & Current Ratings

32Vac

AGW-1	AGW-4	AGW-15
AGW-1 1/2	AGW-5	AGW-20
AGW-2	AGW-6	AGW-25
AGW-2 1/2	AGW-7 1/2	AGW-30
AGW-3	AGW-10	—

Data Sheet: 2040



AGX AGX-V (Axial Leads)*

Fast Acting

Physical Size:

1/4" x 1" (8AG)
(6.4mm x 25.4mm)

Construction: Glass Tube

Voltage Rating: See table below.

Agency Information: Std. 248-14

UL File E19180

UL Listed, Guide JDYX, 0-5A

UL Recognized, Guide JDYX2, 6-20A

CSA File 47233; Class 1422-01, 0-5A

CE CE logo denotes compliance with European Union Low Voltage Directive (50-1000Vac, 75-1500Vdc). Refer to Data Sheet: 8002 or contact Bussmann Application Engineering at 636-527-1270 for more information.

Catalog Symbol & Current Ratings

250Vac/35A (1/500-1 1/2A), 100A (3/4-1 1/2A)

AGX-1/500	AGX-3/16	AGX-3/4
AGX-1/200	AGX-2/10	AGX-1
AGX-1/100	AGX-1/4	AGX-1 1/4
AGX-1/32	AGX-3/10	AGX-1 1/2
AGX-1/16	AGX-3/8	AGX-2
AGX-1/10	AGX-4/10	—
AGX-1/8	AGX-1/2	—
125Vac/10kA		
AGX-2 1/2	AGX-4	AGX-6
AGX-3	AGX-5	AGX-7
32 V/1kA		
AGX-8	AGX-15	AGX-25
AGX-10	AGX-20	AGX-30

* AGX-V is UL Recognized from 6-20A @ 32Vac

Data Sheet: 2041



1/4" Diameter x 1" Lengths



TDC180

British Household Plug Fuse
Fast/Medium

Physical Size:

1/4" x 1"
(6.4mm x 25.4mm)

Construction: Ceramic Tube
End Caps: Silver-plated copper

Agency Information:
BS1362, IEC 269-3A

Catalog Symbol & Current Ratings

240Vac		
TDC180-1	TDC180-5	TDC180-13
TDC180-2	TDC180-7	—
TDC180-3	TDC180-10	—

CE logo denotes compliance with European Union Low Voltage Directive (50-1000Vac, 75-1500Vdc). Refer to Data Sheet: 8002 or contact Bussmann Application Engineering at 636-527-1270 for more information.

Data Sheet: 2042



TDC600

Fast Acting
Physical Size:

1/4" x 1"
(6.3mm x 25.4mm)

Construction: Ceramic Tube
Voltage Rating: 600Vac

Agency Information:
UL Recognized, Std. 248-14, BS1362

Catalog Symbol & Current Ratings

TDC600-2A	TDC600-10A
-----------	------------

CE logo denotes compliance with European Union Low Voltage Directive (50-1000Vac, 75-1500Vdc). Refer to Data Sheet: 8002 or contact Bussmann Application Engineering at 636-527-1270 for more information.

Data Sheet: 2081



FWH

Semiconductor Fuse
Physical Size:

1/4" x 1 1/4"
(6.3mm x 32mm)

Construction: Ceramic Tube
Voltage Rating:

500Vac/50kA (.25-20A)
500Vac/20kA (25A, 30A)

Agency Information: Std. 248-14
UL Recognized .25-7, 500Vac,

File E91958, Guide JFHR2
UL Recognized 10-30, 500Vac,
File E56412, Guide JFHR2

Catalog Symbol & Current Ratings

FWH-.250A6F	FWH-010A6F
FWH-.500A6F	FWH-12.5A6F
FWH-001A6F	FWH-015A6F
FWH-002A6F	FWH-016A6F
FWH-3.15A6F	FWH-020A6F
FWH-005A6F	FWH-025A6F
FWH-6.30A6F	FWH-030A6F
FWH-007A6F	

CE logo denotes compliance with European Union Low Voltage Directive (50-1000Vac, 75-1500Vdc). Refer to Data Sheet: 8002 or contact Bussmann Application Engineering at 636-527-1270 for more information.

Data Sheet: 720038 (Fuse)
Time-Current 35785256, 50955



1/4" x 1 1/4" Fast Acting Fuses

TDC10

Fast Acting

Physical Size:

1/4" x 1 1/4" (3AG)
(6.3mm x 32mm)

Construction: Glass Tube

Voltage Rating: See Below

Agency Information:

Conforms to British Standard
BS-2950A, I.R. 10Im@Vm.



CE CE logo denotes compliance with European Union Low Voltage Directive (50-1000Vac, 75-1500Vdc). Refer to Data Sheet: 8002 or contact Bussmann Application Engineering at 636-527-1270 for more information.

Catalog Symbol & Current Ratings

1000Vac	250Vac
TDC10-50mA	TDC10-1.5A
TDC10-60mA	TDC10-2A
TDC10-100mA	TDC10-3A
TDC10-150mA	TDC10-5A
TDC10-250mA	150Vac
750Vac	TDC10-7A
TDC10-500mA	100Vac
500Vac	TDC10-10A
TDC10-750mA	32Vac
350Vac	TDC10-12A
TDC10-1A	TDC10-15A
—	TDC10-20A
—	TDC10-25A

AGC AGC-V (Axial Leads)

Fast Acting

Physical Size:

1/4" x 1 1/4" (3AG)
(6.3mm x 32mm)

Construction:

Glass Tube
Nickel Plated Brass
End Caps

Voltage Rating: See Below

Interrupting Rating: See Below

Agency Information: Std. 248-14

UL Listed, Guide JDYX, File E19180, 0-10A

UL Recognized, Guide JDYX2,

File E19180, 15-30A

CSA Certification, Class 1422-01,

File 53787



CE CE logo denotes compliance with European Union Low Voltage Directive (50-1000Vac, 75-1500Vdc). Refer to Data Sheet: 8002 or contact Bussmann Application Engineering at 636-527-1270 for more information.

Electrical Characteristics

Current Rating	Rated Voltage		Interrupting Rating ¹	
	ac (Max.)		ac	
1/20	250V		35A	
1/16	250V		35A	
1/10	250V		35A	
1/6	250V		35A	
3/16	250V		35A	
2/10	250V		35A	
1/4	t250V		35A	
3/10	250V		35A	
2/6	250V		35A	
45/100	t250V		35A	
1/2	250V		35A	
3/4	250V		35A	
1	250V		35A	
1 1/4	250V		100A	
1 1/2	250V		100A	
2	250V		100A	
2 1/4	250V		100A	
2 1/2	250V		100A	
3	250V		100A	
4	250V		200A	
5	250V		200A	
6	250V		200A	
7	250V		200A	
8	250V		200A	
9	250V		200A	
10	250V		200A	
15	32V		1000A	
20	32V		1000A	
25	32V		1000A	
30	32V		1000A	

¹Interrupting ratings were measured at 70% - 80% power factor on AC, and at a time constant described in UL 248.

Data Sheet: 2001

ABC ABC-V (Axial Leads)

Fast Acting

Physical Size:

1/4" x 1 1/4" (3AB)
(6.3mm x 32mm)

Construction:

Ceramic Tube
Nickel Plated
Brass End Caps

Voltage Rating: See Below

Interrupting Rating: See Below

Agency Information: Std. 248-14

UL Listed, Guide JDYX File E19180, 0-15A

UL Recognized, Guide JDYX2,

File E19180, 20-25A

CSA Certification, Class 1422-01,

File 53787, 0-15A, Class 1422-30,

File 53787, 20-25A



CE CE logo denotes compliance with European Union Low Voltage Directive (50-1000Vac, 75-1500Vdc). Refer to Data Sheet: 8002 or contact Bussmann Application Engineering at 636-527-1270 for more information.

Electrical Characteristics

Current Rating	Rated Voltage		Interrupting Rating ¹	
	ac (Max.)	dc (Max.)	ac	dc
1/4	250V	125V	35A	10kA
1/2	250V	125V	35A	10kA
3/4	250V	125V	35A	10kA
1	250V	125V	35A	10kA
1 1/2	250V	125V	100A	10kA
2	250V	125V	100A	10kA
2 1/2	250V	125V	100A	10kA
3	250V	125V	100A	10kA
4	250V	125V	200A	10kA
5	250V	125V	200A	10kA
6	250V	125V	200A	10kA
7	250V	125V	200A	10kA
8	250V	125V	200A	10kA
10	250V	125V	200A	10kA
15	250V	125V	750A	10kA
20	250V	125V	400A	10kA
25	125V	125V	1000A	400A
30	125V	125V	1000A	400A

¹Interrupting ratings were measured at 70% - 80% power factor on AC, and at a time constant described in UL 248.

Data Sheet: 2000

Data Sheet: 2043



1/4" x 1 1/4" Fuses

GBB GBB-V (Axial Leads)

Very Fast Acting

Physical Size:

1/4" x 1 1/4" (3AB)
(6.3mm x 32mm)

Construction:

Ceramic Cartridge
Nickel Plated
Brass End Caps

Voltage Rating: 250Vac/125Vdc

Interrupting Rating:

200A @ 250Vac
10kA @ 125Vac/dc (1-15A),
200A @ 125Vac/dc (20-30A)

Agency Information: Std. 248-14
UL Recognized, 1-30, 125Vdc/250Vac,
File E56412, Guide JFHR2
CSA Certified, 1-10, 125Vdc/250Vac,
File 53787, Class 1422-01



CE CE logo denotes compliance with European Union Low Voltage Directive (50-1000Vac, 75-1500Vdc). Refer to Data Sheet: 8002 or contact Bussmann Application Engineering at 636-527-1270 for more information.

Catalog Symbol and Current Ratings

GBB-1	GBB-6	GBB-15
GBB-1 1/4	GBB-7	GBB-20
GBB-2	GBB-8	GBB-25
GBB-3	GBB-9	GBB-30
GBB-4	GBB-10	—
GBB-5	GBB-12	—

TDC11

Time Lag

Physical Size:

1/4" x 1 1/4" (3AG)
(6.3mm x 32mm)

Construction:

Glass Tube

Voltage Rating:

See Below

Interrupting

Rating: 10 times rated
current @ Vm.



CE CE logo denotes compliance with European Union Low Voltage Directive (50-1000Vac, 75-1500Vdc). Refer to Data Sheet: 8002 or contact Bussmann Application Engineering at 636-527-1270 for more information.

Catalog Symbol and Current Ratings

1000Vac	250Vac
TDC11-50mA	TDC11-1.5A
TDC11-60mA	TDC11-2A
TDC11-100mA	TDC11-3A
TDC11-150mA	TDC11-5A
TDC11-250mA	150Vac
750Vac	TDC11-7A
TDC11-500mA	100Vac
500Vac	TDC11-10A
TDC11-750mA	—
350Vac	—
TDC11-1A	—

Data Sheet: 2013

MDL MDL-V (Axial Leads)

Time-Delay

Physical Size:

1/4" x 1 1/4" (3AG)
(6.3mm x 32mm)

Construction:

Glass Tube
Nickel Plated
Brass End Caps

Voltage Rating: See Below

Interrupting Rating: See Below

Agency Information: Std. 248-14
UL Listed, Guide JDYX, File E19180;

1/16-8A
CSA Certification Class 1422-01,
File 53787, 1/16-8A
UL Recognized, Guide JDYX2,
File E19180, 8.1-30A



CE CE logo denotes compliance with European Union Low Voltage Directive (50-1000Vac, 75-1500Vdc). Refer to Data Sheet: 8002 or contact Bussmann Application Engineering at 636-527-1270 for more information.

Electrical Characteristics

Current Rating	Rated Voltage	Interrupting Rating ¹
	ac (Max.)	ac
1/16	250V	35A
1/10	250V	35A
1/8	250V	35A
3/10	250V	35A
3/16	250V	35A
1/4	250V	35A
3/10	250V	35A
3/8	250V	35A
1/2	250V	35A
3/4	250V	35A
1	250V	35A
1 1/4	250V	100A
1 1/2	250V	100A
2	250V	100A
2 1/4	250V	100A
2 1/2	250V	100A
3	250V	100A
4	250V	200A
5	250V	200A
6	250V	200A
7	250V	200A
8	250V	200A
9	32V	1000A
10	32V	1000A
12	32V	1000A
15	32V	1000A
20	32V	1000A
25	32V	1000A
30	32V	1000A

¹Interrupting ratings were measured at 70% – 80% power factor on ac, and at a time constant described in UL 198L.

Data Sheet: 2043

Data Sheet: 2004



1/4" x 1 1/4" and 1 3/32" x 1 1/2" Fuses



MDQ
MDQ-V (Axial Leads)

Dual Element Time-Delay

Physical Size:

1/4" x 1 1/4" (3AG)
(6.3mm x 32mm)

Construction: Glass Tube; Nickel
Plated Brass End Caps

Agency Information: Std. 248-14
UL Listed, File E19180; Guide JDYX,
1/16-7A
CSA Certification, File 47233,
Class 1422-01, 1/16-7A
UL Recognized, Guide JDYX2,
File E19180, 7.1-30A

CE logo denotes compliance with European Union Low Voltage Directive (50-1000Vac, 75-1500Vdc). Refer to Data Sheet: 8002 or contact Bussmann Application Engineering at 636-527-1270 for more information.

Catalog Symbol & Current Ratings

250Vac			
MDQ-1/100	MDQ-3/6	MDQ-19/10	MDQ-7
MDQ-1/32	MDQ-1/10	MDQ-2	
MDQ-1/16	MDQ-1/2	MDQ-2 1/4	
MDQ-1/10	MDQ-9/10	MDQ-2 1/2	
MDQ-1/8	MDQ-3/4	MDQ-2 9/10	
MDQ-15/100	MDQ-9/10	MDQ-3	
MDQ-17 1/2/1000	MDQ-1	MDQ-3 9/10	
MDQ-9/16	MDQ-1 1/10	MDQ-4	
MDQ-9/10	MDQ-1 1/4	MDQ-5	
MDQ-1/4	MDQ-1 1/2	MDQ-6	
MDQ-3/10	MDQ-1 9/10	MDQ-6 1/4	
32Vac			
MDQ-7 1/2	MDQ-9	MDQ-12	
MDQ-8	MDQ-10	MDQ-15	

Voltage: 250Vac (1/100A-7A)
32Vac (7 1/2A-7A)

Interrupting Rating:

35A @ 250Vac (1/16A-1A)
100A @ 250Vac (1 1/4A-3A)
200A @ 25Vac (4A-7A)
1kA @ 32Vac (7 1/2A-12A)

Data Sheet: 2044



MDA
MDA-V (Axial Leads)

Time-Delay

Physical Size:

1/4" x 1 1/4" (3AB)
(6.3mm x 32mm)

Construction: Ceramic Tube; Nickel
Plated Brass End Caps

Agency Information: Std. 248-14
UL Listed, Guide JDYX, File E19180,
0-15A
CSA Certification, Class 1422-01,
File 53787, 0-15A

CE logo denotes compliance with European Union Low Voltage Directive (50-1000Vac, 75-1500Vdc). Refer to Data Sheet: 8002 or contact Bussmann Application Engineering at 636-527-1270 for more information.

Electrical Characteristics

Current Rating	Rated Voltage		Interrupting Rating ¹	
	ac (Max.)	dc (Max.)	ac	dc
3/10	250V		35A	
	250V		35A	
	250V		35A	
1/4	250V		35A	
	250V		35A	
	250V		100A	
1 1/2	250V		100A	
	250V		100A	
	250V		100A	
2	250V		200A	
	250V		200A	
	250V		200A	
2 1/2	250V		200A	
	250V		200A	
	250V		200A	
3	250V		200A	
	250V		200A	
	250V		200A	
4	250V		200A	
	250V		200A	
	250V		200A	
5	250V		200A	
	250V		200A	
	250V		200A	
6	250V		200A	
	250V		200A	
	250V		200A	
7	250V		200A	
	250V		200A	
	250V		200A	
8	250V		200A	
	250V		200A	
	250V		200A	
10	250V		200A	
	250V		200A	
	250V		200A	
MDA-12	250V		1500A	
	250V	125V	1500A	10kA
	250V	125V	1000A	10kA
30	250V	125V	1000A	10kA

¹Interrupting ratings were measured at 70% - 80% power factor on ac, and at a time constant described in UL 248.

Data Sheet: 2002



AGU
Fast Acting

Physical Size:

1 3/32" x 1 1/2" (5 AG)
(10.3mm x 38.1mm)

Construction: Glass Tube

No Agency Listings

CE logo denotes compliance with European Union Low Voltage Directive (50-1000Vac, 75-1500Vdc). Refer to Data Sheet: 8002 or contact Bussmann Application Engineering at 636-527-1270 for more information.

Catalog Symbol & Current Ratings

250Vac	32Vac		
AGU-1	AGU-4	AGU-20	AGU-50
AGU-2	AGU-5	AGU-25	AGU-60
AGU-3	AGU-8	AGU-30	—
—	AGU-10	AGU-35	—
—	AGU-15	AGU-40	—

Data Sheet: 2008



Pin Indication Type



GBA and GLD

Fast Acting

Physical Size:

1/4" x 1 1/4" (3AG)
(6.6mm x 31.8mm)

Agency Information: Std. 248-14
UL Listed, 0-5A/125Vac,
10,000 AIC, Guide JDYX,
File E19180

UL Recognized,
6A/125Vac, 1000AIC
8-15A/50Vac/dc, 300 AIC
Guide JDYX2, File E19180
CSA Certified:
0-5A/125Vac, 10,000 AIC
Class 1422-01, File 53787

General Information: Type GBA
has a "red" pin for high visibility. Type
GLD has an Albaloy-plated pin for
positive, electrical signal circuit
activation.

CE CE logo denotes compliance with European Union Low Voltage Directive (50-1000Vac, 75-1500Vdc). Refer to Data Sheet: 8002 or contact Bussmann Application Engineering at 636-527-1270 for more information.

Catalog Symbol & Current Ratings

GLD-1/2	GLD-2	GLD-6
GLD-3/4	GLD-3	GLD-10
GLD-1	GLD-4	GLD-12
GLD-1 1/2	GLD-5	GLD-15
GBA-1/2	GBA-2	GBA-8
GBA-3/4	GBA-3	GBA-10
GBA-1	GBA-4	GBA-15
GBA-1 1/2	GBA-5	



MIC and MIN

Fast Acting

Physical Size:

1 3/32" x 1 1/2" (5AG)
(10.3mm x 38.1mm)

Agency Information: Std. 248-14
MIC—0-15A UL Listed, Guide JDYX,
File E19180
MIN—1-5A CSA Certified,
Class 1422-01, File 53787

General Information: Type MIN
has a "red" pin for high visibility. Type
MIC has a silver-plated pin for positive,
electrical signal activation.

CE CE logo denotes compliance with European Union Low Voltage Directive (50-1000Vac, 75-1500Vdc). Refer to Data Sheet: 8002 or contact Bussmann Application Engineering at 636-527-1270 for more information.

Catalog Symbol & Current Ratings

250Vac		32V
MIC-1 (IR = 35A)	MIC-5 (IR = 200A)	MIC-20 (IR = 10kA)
MIC-2 (IR = 100A)	MIC-10 (IR = 200A)	MIC-25 (IR = 10kA)
MIC-3 (IR = 100A)	MIC-15 (IR = 750A)	MIC-30 (IR = 10kA)
MIC - (1-15)UL Listed 125Vac / IR = 10kA		
250Vac		32V
MIN-1 (IR = 35A)	MIN-5 (IR = 200A)	MIN-20 (IR = 10kA)
MIN-2 (IR = 100A)	MIN-10 (IR = 200A)	MIN-25N (IR = 10kA)
MIN-3 (IR = 100A)	MIN-15 (IR = 750A)	MIN-30 (IR = 10kA)



FNA

Time-Delay

Physical Size:

1 3/32" x 1 1/2"
(10.3mm x 38.1mm)

Agency Information: Std. 248-14
UL Listed 1/10-8/10A, IR 35A@ 250V
IR 10kA@ 125V
1-15A, IR 10kA@ 125V

Guide JDYX, File 19180
CSA Certified, 0-8/10 A/250V,
1-10A/125V, Class 1422-01,
File 53787

General Information: Fuses above
10A have dual-tube construction.

CE CE logo denotes compliance with European Union Low Voltage Directive (50-1000Vac, 75-1500Vdc). Refer to Data Sheet: 8002 or contact Bussmann Application Engineering at 636-527-1270 for more information.

Catalog Symbol & Current Ratings

250Vac IR*	125Vac IR	125Vac IR	125Vac
FNA-1/10	FNA-1	FNA-3	FNA-9
FNA-1/8	FNA-1 1/8	FNA-3 3/10	FNA-10 IR
FNA-1/100	FNA-1 1/4	FNA-3 1/2	FNA-12 10,000A
FNA-1/10	FNA-1 1/10	FNA-4	FNA-15
FNA-1/4 IR	FNA-1 1/2 IR	FNA-4 1/2 IR	FNA-20
FNA-3/10 IR 35A	FNA-1 5/10 10,000A	FNA-5 10,000A	FNA-20
FNA-1/10	FNA-1 1/10	FNA-5 1/10	FNA-25 IR 3% 1kA@ 32V
FNA-1/2	FNA-2	FNA-6	FNA-30 32V
FNA-9/10	FNA-2 1/4	FNA-6 1/4	—
FNA-3/4	FNA-2 1/2	FNA-7	—
FNA-9/10	FNA-2 5/10	FNA-8	—

*Interrupting rating of 10,000A at 125V.
†Interrupting rating of 1,000A at 32V.



Pin Indication Type/Actuators/Limiters



MIS

Non-Time-Delay

Physical Size:

$1\frac{3}{32}'' \times 2''$
(10.3mm × 50.8mm)

Voltage Rating: 600Vac

Interrupting Rating: 200,000 AIC

Catalog Symbol & Current Ratings

600Vac

MIS-1	MIS-4	MIS-10
MIS-2	MIS-5	MIS-12
MIS-3	MIS-8	

Test Specifications

Fuse	Load	Opening Time
All	110%	4 hrs. (min.)
1-5A	150%	6 min. (max.)
6-12A	150%	12 min. (max.)



KAZ

Actuator (Not a Fuse)

Physical Size:

$1\frac{3}{32}'' \times 2''$
(10.3mm × 50.8mm)

Voltage Rating: 600Vac

Interrupting Rating: 200,000A

Agency Information:

UL Listed, Guide JDVS,
File E58836

Recommended Use: Mounts in Buss signal blocks 2778, 2837 and 2838.

General Information: Connects in parallel with fuses having a rating of 50 amperes or larger and opens at 10A or more.

CE CE logo denotes compliance with European Union Low Voltage Directive (50-1000Vac, 75-1500Vdc). Refer to Data Sheet: 8002 or contact Bussmann Application Engineering at 636-527-1270 for more information.

Data Sheet: 2021

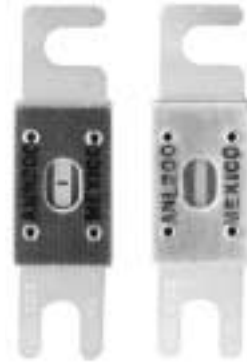

ANN Limiter

Very Fast Acting

Physical Size:

$\frac{7}{8}'' \times 3\frac{3}{16}''$
(22.2mm × 81.0mm)

Voltage Rating: 125Vac IR = 2500A
80Vdc IR = 2700 A

Agency Information: 35-400A @ 125Vac, IR=2500A and 80Vdc, IR=2700A: UL Recognized Guide JFHR2, File E56412; CSA Certified Class 1422-30, File 53787

CE for 35-400A

Fuseholder: 4164

Catalog Symbol & Current Ratings

ANN-10	ANN-90	ANN-225	ANN-400
ANN-35	ANN-100	ANN-250	ANN-500
ANN-40	ANN-125	ANN-275	ANN-600
ANN-50	ANN-150	ANN-300	ANN-700
ANN-60	ANN-175	ANN-325	ANN-800
ANN-80	ANN-200	ANN-350	

Data Sheet: 2023 & 2133

ANL

Non-Time Delay

Voltage Rating: 80Vdc

Agency Information:

UL Recognized, CSA Certified, 35-750A @ 80Vdc, IR = 2700A
Guide JFHR2, File E56412
Class 1422-30, File 53787

Fuseholder: 4164

Catalog Symbol & Current Ratings

ANL-35	ANL-125	ANL-250	ANL-500
ANL-40	ANL-130	ANL-275	ANL-600
ANL-50	ANL-150	ANL-300	ANL-675
ANL-60	ANL-175	ANL-325	ANL-750
ANL-80	ANL-200	ANL-350	—
ANL-100	ANL-225	ANL-400	—

Data Sheet: 2024 & 2133



In-Line Fuse and Fuseholders

GLR

Fast Acting, Non-rejecting
Voltage Rating: 300Vac or less
Interrupting Rating: 10,000A
Agency Information: Std. 248-14
 UL Listed, 0-15A/300Vac
 (Guide JDYX, File E19180)
 CSA Certified, 0-10A/300V
 (Class 1422-01, File 53787)



*HLR Fuseholder



GMF and GRF

Time Delay, Non-rejecting
Voltage Rating: 300Vac or less
Interrupting Rating: 10,000A
Agency Information: Std. 248-14
 0-10A, UL Listed (Guide JDYX,
 File E19180)
 CSA Certified, (Class 1422-01,
 File 53787)



Electrical Ratings for Type GLR Fuses and Non-Rejection Style Carriers

Fuse	Carrier ^{1, 2}	Fuse	Carrier ^{1, 2}
GLR-3/16	HLR	GLR-5	HLR
GLR-1/2	HLR	GLR-6	HLR
GLR-1	HLR	GLR-7	HLR
GLR-1 1/2	HLR	GLR-8	HLR
GLR-1 9/10	HLR	GLR-9	HLR
GLR-2	HLR	GLR-10	HLR
GLR-3	HLR	GLR-12	HLR
GLR-4	HLR	GLR-15	HLR-2A

- Carrier is UL Recognized, Guide IZLT2, File E14853 and CSA Certified, Class 6225-01, File 47235 12A, 300Vac.
- Units can be panel-mounted either in a knockout hole with a separate steel clip (BK/A-104) or in a keyhole punch using separate mounting clip #6374 for panels of thickness 0.043" to 0.062" or #4909 for thickness 0.030" to 0.042"
 *For two leads order HLR-2A, 15A, 300V
- An alternative to the HLR fuseholder is the A fuseholder. The A fuseholder comes *WITHOUT* leads. The customer inserts #18 insulated solid copper wire into the line side receptacle as well as into the load side receptacle. It has the same body dimensions, utilizes the same mounting hole, and takes the same mounting clips as the HLR. The A fuseholder is UL Recognized, 10A, 300Vac, Guide IZLT2, File E14853 and CSA Certified, 10A, 300Vac, Class 6225-01, File 47235.
- Do not put tension on line (rear) terminal of fuseholder.

CE CE logo denotes compliance with European Union Low Voltage Directive (50-1000Vac, 75-1500Vdc). Refer to Data Sheet: 8002 or contact Bussmann Application Engineering at 636-527-1270 for more information.

Data Sheet: 2032

GLQ

Fast-Acting, Size Rejecting
Voltage Rating: 300Vac or less
Interrupting Rating: 10,000A
Agency Information: Std. 248-14
 UL Listed (Guide JDYX,
 File E19180)
 CSA Certified, (Class 1422-01,
 File 53787)



HLQ³ Fuseholder



GMQ

Time-Delay, Size Rejecting
Voltage Rating: 300Vac or less
Interrupting Rating: 10,000A
Agency Information: Std. 248-14
 UL Listed (Guide JDYX, File E19180)
 CSA Certified, (Class 1422-01,
 File 53787)



Electrical Ratings for Type GLQ Fuses and Rejection Style Carriers

Fuse	Carrier ^{3, 4}	Fuse	Carrier ^{3, 4}
GLQ-1	HLQ-1 9/10	GLQ-3	HLQ-3 9/10
GLQ-1 1/2	HLQ-1 9/10	GLQ-4	HLQ-5
GLQ-1 9/10	HLQ-1 9/10	GLQ-5	HLQ-5
GLQ-2	HLQ-3 9/10	GLQ-9	HLQ-10
GLQ-2 1/2	HLQ-3 9/10	GLQ-10	HLQ-10

- Carrier is UL Recognized, Guide IZLT2, File E14853 and CSA Certified, Class 6225-01, File 47235 10A, 300Vac.
- Units can be panel-mounted either in a knockout hole with a separate steel clip (BK/A-104) or in a keyhole punch using separate mounting clip #6374 for panels of thickness 0.043" to 0.062" or #4909 for thickness 0.030" to 0.042"
 *Do not put tension on line (rear) terminal of fuseholder.

CE CE logo denotes compliance with European Union Low Voltage Directive (50-1000Vac, 75-1500Vdc). Refer to Data Sheet: 8002 or contact Bussmann Application Engineering at 636-527-1270 for more information.

Data Sheet: 2033

Electrical Ratings for Type GMQ Fuses and Rejection Style Carriers

Fuse	Carrier ^{3, 4}	Fuse	Carrier ^{3, 4}
GMQ-1/2	HLQ-1/2	GMQ-2 1/2	HLQ-3 9/10
GMQ-9/10	HLQ-1 9/10	GMQ-3	HLQ-3 9/10
GMQ-9/10	HLQ-1 9/10	GMQ-3 9/10	HLQ-3 9/10
GMQ-1	HLQ-1 9/10	GMQ-4	HLQ-5
GMQ-1 1/4	HLQ-1 9/10	GMQ-6	HLQ-8
GMQ-1 9/10	HLQ-1 9/10	GMQ-6 1/4	
GMQ-2	HLQ-3 9/10		

- Carrier is UL Recognized, Guide IZLT2, File E14853 and CSA Certified, Class 6225-01, File 47235 10A, 300Vac.
- Units can be panel-mounted either in a knockout hole with a separate steel clip (BK/A-104) or in a keyhole punch using separate mounting clip #6374 for panels of thickness 0.043" to 0.062" or #4909 for thickness 0.030" to 0.042"
 *Do not put tension on line (rear) terminal of fuseholder.

CE CE logo denotes compliance with European Union Low Voltage Directive (50-1000Vac, 75-1500Vdc). Refer to Data Sheet: 8002 or contact Bussmann Application Engineering at 636-527-1270 for more information.

Data Sheet: 2030



Blade-Type Fuses



ATC® Blade-Type Fuse

Fast Acting

Voltage Rating: 32Vdc

Interrupting Rating: 1,000A

Agency Information:

UL Recognized, (3-40A)

(Guide JFHR2, File E56412)

Catalog Symbol & Current Ratings

ATC-1	Black
ATC-2	Gray
ATC-3	Violet
ATC-4	Pink
ATC-5	Tan
ATC-7½	Brown
ATC-10	Red
ATC-15	Blue
ATC-20	Yellow
ATC-25	Clear
ATC-30	Green
ATC-40	Orange

Refer to page 82 for In-Line Fuseholders for Blade Type Fuses.

Data Sheet: 2009



ATM Mini-Fuse®

Fast Acting

Voltage Rating: 32Vdc

Interrupting Rating: 1,000A

Catalog Symbol & Current Ratings

ATM-2	Gray
ATM-3	Violet
ATM-4	Pink
ATM-5	Tan
ATM-7½	Brown
ATM-10	Red
ATM-15	Blue
ATM-20	Yellow
ATM-25	Clear
ATM-30	Green

Refer to page 82 for In-Line Fuseholders for Blade Type Fuses.

Data Sheet: 2048

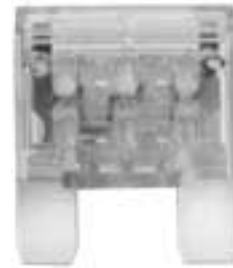

MAX Maxi-Fuse®

Fast Acting

Voltage Rating: 32Vdc

Interrupting Rating: 1,000A

Catalog Symbol & Current Ratings

MAX-20	Yellow
MAX-30	Green
MAX-40	Orange
MAX-50	Red
MAX-60	Blue
MAX-70	Tan
MAX-80	Clear

Refer to page 82 for In-Line Fuseholders for Blade Type Fuses.

Data Sheet: 2049



Optima® Three Pole Overcurrent Protection Module



Class CC Version

Catalog Symbol: OPM-NG-SC3

Electrical Rating: 30A, 600Vac (or less)

Withstand Rating: 200kA

Use with Class CC fuse type: LP-CC, FNQ-R, KTK-R

13/32" x 1-1/2" and 10,3 x 38mm Version

Catalog Symbol: OPM-NG-SM3

Electrical Rating: UL and CSA 30A, 600Vac (or less)
IEC 32A, 690Vac (or less)

Withstand Rating: Limited by fuse IR, 200kA maximum

Use with 13/32" x 1-1/2" fuse types: KTK, FNQ, KLM

Use with 10 x 38mm fuse types: FWA, FWC,
C10G_-, C10M_-

Agency Information:

UL

OPM-NG-SC3

UL Listed, UL 512, File E14853, Guide IZLT

OPM-NG-SM3

UL Recognized, UL512, File E14853, Guide IZLT2

CSA Certified, C22.2 No. 39, Class C6225-01, File 47235

IEC 60947-3 Utilization Category AC20B

Packaging Weight: 0.39lb. (0.18 kg)

Handling & Storage Specifications:

Storage Temperature: -10°C to 65°C

Attributes:

- 45mm width matches IEC starters.
- Phil-slot screws.
- Pressure plate terminations.
- Integrated collapsible handle.
- Fuse carrier cannot be removed from holder base.
- IP20 finger safe to IEC60529
- Auxilliary contacts. - optional accessory
- Dual-wire rated terminals (see Wire Table).
- 35mm DIN rail or panel mounting feature. Maximum screw size #8 (M4).
- Padlockable

CE logo denotes compliance with European Union Low Voltage Directive (50-1000 Vac, 75-1500 Vdc). Refer to Data Sheet: 8002 or contact Bussmann Application Engineering at 636-527-1270 for more information.

Fuseholder Wire Range:

75°C CU Only

#18-12 Single/Dual, torque 15 lb. in.

#10-8 Single/Dual, torque 20 lb. in.

Dual wire. Wire with same gauge and type

		75°C CU Only		C (Nm)/lb in
		AWG	[mm ²]	
Solid		18-8 x1	1.6 x1	18-12 Single/Dual 15 lb in (1.7 Nm)
		18-8 x2	1.6 x2	
Stranded		18-8 x1	1.5.6 x1	10-8 Single/Dual 20 lb in (2.5 Nm)
		18-8 x2	1.5.6 x2	
Ferrules			1.4 x1	
			1.4 x2	

Input Power Terminal Wire Range:

Wiring		
Solid Conductor		(1) #14 to #2 (1.5 to 25mm ²) conductor or
		(2) #14 to #6 (1.5 to 10mm ²) conductors
Stranded Conductor		(1) #14 to #2 (1.5 to 25mm ²) conductor or
		(2) #12 to #6 (2.5 to 10mm ²) conductors
Tightening Torque:	Connector	20 lb. in. (2.2 N·m)
	Screw	15 lb. in. (1.7 N·m)
	Clamp	

Materials:

Housing: Thermoplastic- UL V-2

Clip: Tin plated copper alloy

Contact Lubricant: Fluoroether grease

Saddle screw: Plated steel

DIN rail springs: Stainless steel

Optional Accessories:

Comb Bar (Max. current rating = 63A)

OPMNGSA245	2 circuit, 45mm between same phases
OPMNGSA254	2 circuit, 54mm between same phases
OPMNGSA272	2 circuit, 72mm between same phases
OPMNGSA345	3 circuit, 45mm between same phases
OPMNGSA354	3 circuit, 54mm between same phases
OPMNGSA445	4 circuit, 45mm between same phases
OPMNGSA454	4 circuit, 54mm between same phases
OPMNGSA472	4 circuit, 72mm between same phases
OPMNGSA554	5 circuit, 54mm between same phases

Input Terminal Block

OPMNGSA005	Input/Feed Through Power Terminal, Supports feed through to another system, DIN-rail mount only
OPMNGSA009	Input Power Terminal

Cover

OPMNGSA010	Protective Cover for unused terminals on comb bar
------------	---

Auxilliary Contacts

OPMNGSAAUX11	NO/NC
OPMNGSAAUX20	NO/NO

Marking Tabs

OPMNGSA101	Marking Tab - Mounts to front of carrier, quantity 100
------------	--

Data Sheet: 1109



Optima® Three Pole Overcurrent Protection Module

Optional Accessories

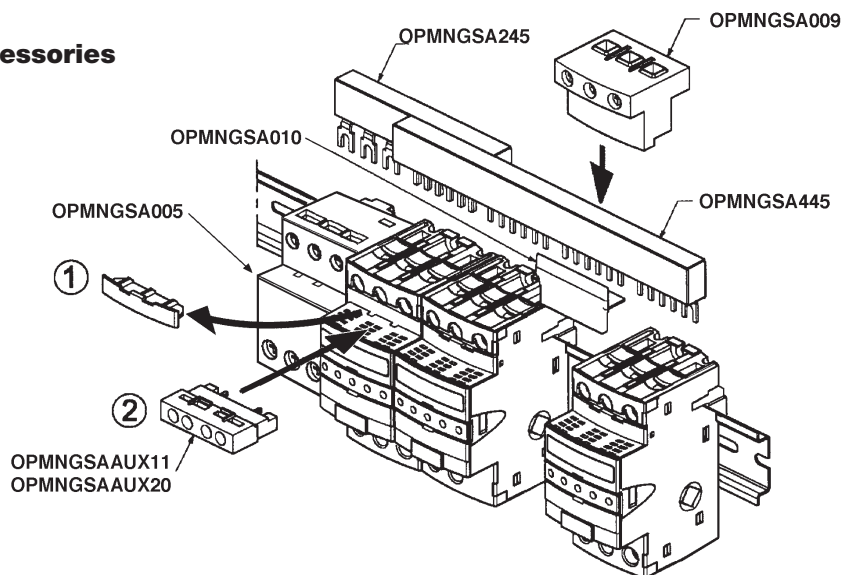

Dimensional Data

Millimeters (± 0.38)
Inches (± .015)

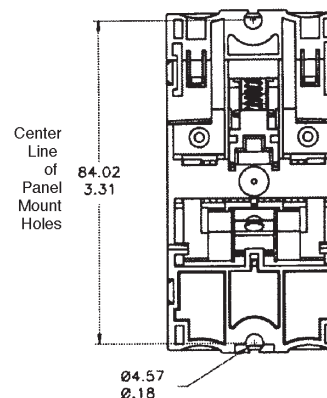
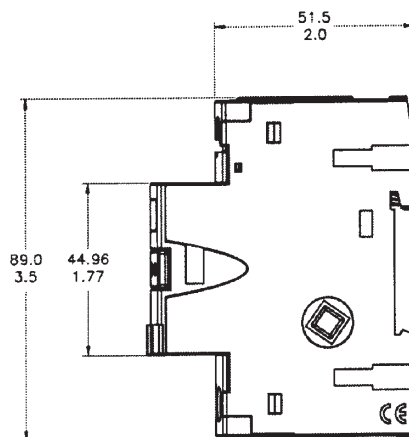
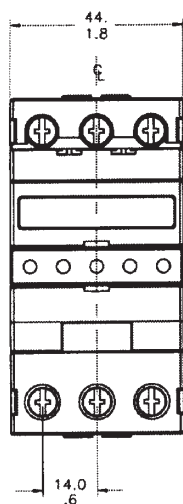
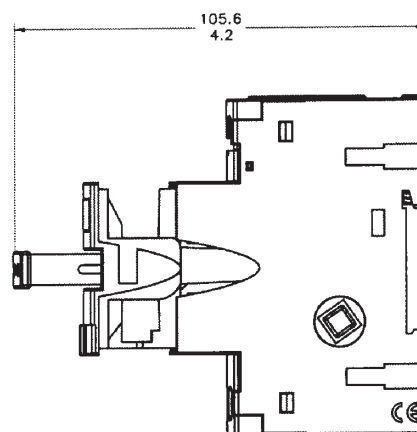
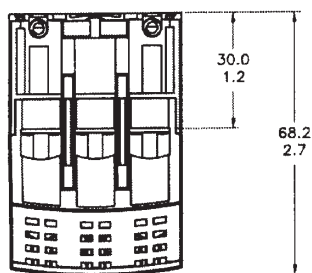

Optima® Overcurrent Protection Module - Fuseholder



Catalog Symbol:

Series	Fuse Type	Communication
OPM-1038	<input type="checkbox"/>	<input type="checkbox"/>
	Blank - 10 x 38mm or 13/32" x 1-1/2"	C - Communication Feature
	R - Class CC	

Non-Switch Series for 13/32" x 1 1/2" (10mm x 38mm) Fuses

Materials: Grey Thermoplastic

UL Flammability: UL 94V0

Agency Information:

UL (see table)

CSA Certified, C22.2 No. 39, Class 6225-01, File 47235

IEC (see table)

Shipping Weight: Approximately 213g/.47 lb.

Carton Quantity: 1

Recommended Fuse Types

Class CC	Midget (Non-Rejection)	European
LP-CC	KTK	C10M
KTK-R	FNM	C10G
FNQ-R	FNQ	

Physical Characteristics

- Small size matches 45mm IEC starter width.
- Accepts #8-18 AWG stranded, #10-18 AWG solid wire.
- 3-pole.

Non-Switch Series

Catalog Number	Electrical Rating	SC Rating	Clips	Remote Open Fuse Indication	UL Information			IEC	CE
					Std.	File	Guide		
OPM-1038	30A, 600V UL/CSA** (Max. 3 Watts per fuse) 32A, 660V IEC	*	Non-rejection, 10 x38mm or 13/32" x 1-1/2"	No	Recognized UL 512	E14853	IZLT2	IEC 269-2-1	Yes
OPM-1038R	30A, 600V UL/CSA**	200kA	Rejection, Class CC	No	Listed UL 512	E14853	IZLT		Yes
OPM-1038C	30A, 600V UL/CSA** (Max. 3 Watts per fuse) 32A, 660V IEC	*	Non-rejection, 10 x38mm or 13/32" x 1-1/2"	Yes	Recognized UL 512	E14853	IZLT2	IEC 269-2-1	No
OPM-1038RC	30A, 600V UL/CSA**	200kA	Rejection, Class CC	Yes	Listed UL 512	E14853	IZLT		No

*Rating varies depending on fuse used in module; 200kA maximum
**DC voltage rating: 600V UL/CSA

Product Features

- "Open" fuse indication lights.
- Cam action handle for easy removal.
- Finger safe terminals. (Qualified as IP20 per IEC 529)
- Removable module for convenient fuse loading.
- 35mm DIN-rail or screw panel mounting (#8 screw, 1 1/4" long).
- Dead-front construction.
- Padlockable.

Additional Features

- Option for remote "open fuse" status indication feature available (less downtime!). See BIF document for additional wiring details.
- Offered with Class CC rejection clips or European 10 x 38mm clips to meet global needs.
- Wire ready: Saves time as terminals are ready to accept wires.

Dimensional Data

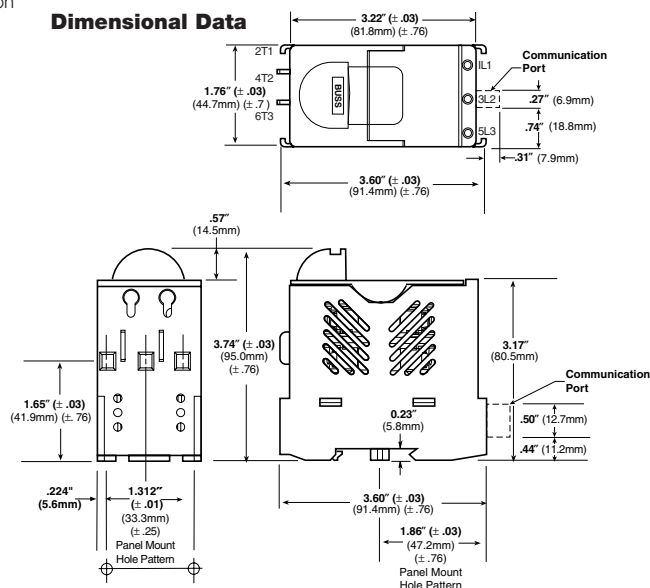

CE CE logo denotes compliance with European Union Low Voltage Directive (50-1000Vac, 75-1500Vdc). Refer to Data Sheet: 8002 or contact Bussmann Application Engineering at 636-527-1270 for more information.



Optima® Overcurrent Protection Module - Fuseholder and Disconnect Switch



Catalog Symbol:

Series Fuse Type Communication

OPM-1038 **SW**

Blank - 10 x 38mm or 13/32" x 1-1/2"
R - Class CC **C** - Communication Feature

Load Break Disconnect Switch for 13/32" x 1 1/2" (10mm x 38mm) Fuses

Materials: Grey Thermoplastic

UL Flammability: UL 94V0

Agency Information:

UL (see table)

CSA Certified, C22.2 No. 39, Class 6225-01, File 47235

IEC (see table)

Shipping Weight: Approximately 335g/.74 lb.

Carton Quantity: 1

Horsepower Rating of Switch

3PH	V	240	480	600
	HP	5	10	15

Recommended Fuse Types

Class CC	Midget (Non-Rejection)	European
LP-CC	KTK	C10M
KTK-R	FNM	C10G
FNQ-R	FNQ	

CE logo denotes compliance with European Union Low Voltage Directive (50-1000Vac, 75-1500Vdc). Refer to Data Sheet: 8002 or contact Bussmann Application Engineering at 636-527-1270 for more information.

Physical Characteristics

- Small size matches 45mm IEC starter width.
- Accepts #8-18 AWG stranded, #10-18 AWG solid wire.
- 3 pole.
- Handle and shaft required for through the door operation. See BIF document for details.

Product Features

- "Open" Fuse indication lights.
- Finger safe terminals.(Qualified as IP20 per IEC 529)
- Cam action handle for easy module removal.
- 35mm DIN-rail or screw panel mounting (#8 screw, 1 1/4" long).
- Dead front construction. No exposed contacts for added safety.
- Padlockable.
- Option for remote "open fuse" status indication feature available (reduces downtime!). See BIF document for additional wiring details.
- Offered with Class CC rejection clips or European 10 x 38mm clips to meet global needs.
- Wire ready: Saves time as terminals are ready to accept wires.

Dimensional Data

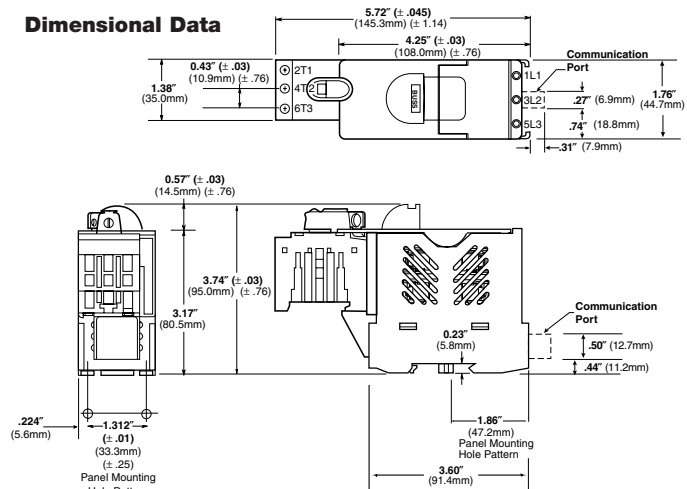

Switch Series

Catalog Number	Electrical Rating	SC Rating	Clips	Remote Open Fuse Indication	UL Information			IEC	CE
					Std.	File	Guide		
OPM-1038SW	30A, 600Vac UL/CSA	*	Non-rejection, 10x38mm or 13/32" x 1-1/2"	No	Recognized			IEC 947-3	Yes
	UL 508				E161278	NLRV2			
OPM-1038RSW	30A, 600Vac UL/CSA	100kA	Rejection, Class CC	No	Listed				Yes
	UL 508				E161278	NLRV			
OPM-1038SWC	30A, 600Vac UL/CSA	*	Non-rejection, 10x38mm or 13/32" x 1-1/2"	Yes	Recognized			IEC 947-3	No
	UL 508				E161278	NLRV2			
OPM-1038RSWC	30A, 600Vac UL/CSA	100kA	Rejection, Class CC	Yes	Listed				No
	UL 508				E161278	NLRV			

*Rating varies depending on fuse used in module; 100kA maximum

Data Sheet: 1103



Blank Page 45
Do Not Print

SAMI Fuse Covers



SAMI Series

For Class J, RK1, RK5, H, K5, CC, G (0-30A) and Midget type fuses.

Voltage Rating:

Non-Indicating - 0-600Vac/dc
 Indicating - 90 to 600Vac
 -115 to 600Vdc

Ampere Rating: 0-100A

Agency Information: UL Listed; SAMI-1I through SAMI-6I
 SAMI-8I and SAMI-9I, SAMI-1N through SAMI-6N, SAMI-8N
 and SAMI-9N

UL Recognized; SAMI-7I and SAMI-7N
 CSA Certified, File LR47235-93C

- Innovative design, covers exposed terminals and contacts of Bussmann fuseblocks.
- Fits most competitive fuseblocks.
- Buss Yellow light on indicating SAMI shows when the fuse is open—helps trouble shoot the system and reduces downtime.
- All versions are reusable—no need to pay for indication every time a fuse opens.
- Indication contacts have teeth to break oxidation layer on the existing fuse endcap to provide a clear signal path.
- Less than .6mA leakage current at 600 volt.
- Visual marking of line and load side.
- SAMI cover ends can easily be cut away if necessary, to fit cover over existing wiring or to fit most safety switches.
- Dead front construction provides added protection against accidental contact by maintenance personnel.
- Labels are provided with the SAMI fuse cover for writing in circuit or fuse information.
- One cover is required for each pole.

Data Sheet: 1204 (Trimming Guides: 12041, 12042, 12043, 12044, 12045, 12046, 12048, 12049)

Dimensional Data (inches)

Catalog Number**	Description	A	B	C
SAMI-1_	600V, J (0-30A) and 600V, T (35-60A)* 250V, RK, K5, H (35-60A)	5.02	1.03	1.94
SAMI-2_	600V, RK, K5, H (0-30A)	7.03	1.30	2.07
SAMI-3_	600V, J (65-100A)	7.03	1.30	2.33
SAMI-4_	250V, RK, K5, H (65-100A)	8.20	1.30	2.18
SAMI-5_	600V, RK, K5, H (35-60A)	8.20	1.30	2.18
SAMI-6_	600V, J (35-60A)	4.98	1.17	2.14
SAMI-7_	600V, Midget, Class CC, G (0-30A)	3.82	0.75	1.72
SAMI-8†_	600V, RK, K5, H (65-100A)	10.38	1.50	2.33
SAMI-9_	250V, RK, K5, H (0-30A) and 600V, T (0-30A)	3.82	0.75	1.72

*Available in non-indicating only.
 †SAMI-8A adapter available for small fuse-tron body design. SAMI-8I and SAMI-8N come standard with adapter (SAMI-8A).

****Catalog Numbers**

For Indicating Cover, add suffix **I**.

For Non-indicating cover, add suffix **N**.

Example: SAMI-7I = Indicating
 SAMI-7N = Non-indicating

Indicating feature requires a minimum of 90Vac or 115Vdc to illuminate lamp.

WARNING: To avoid electrical shock, turn power off before installing, removing or servicing.

Dimensional Data

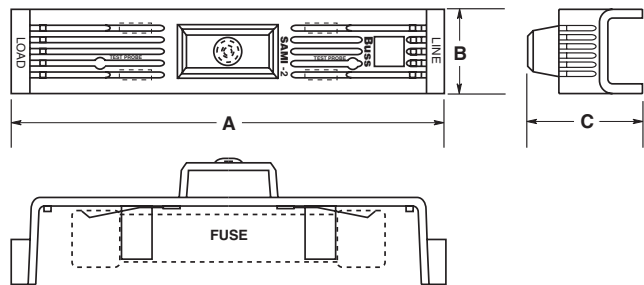

CE CE logo denotes compliance with European Union Low Voltage Directive (50-1000Vac, 75-1500Vdc). Refer to Data Sheet: 8002 or contact Bussmann Application Engineering at 636-527-1270 for more information.



Class H(K) and R Fuseblocks – 250V

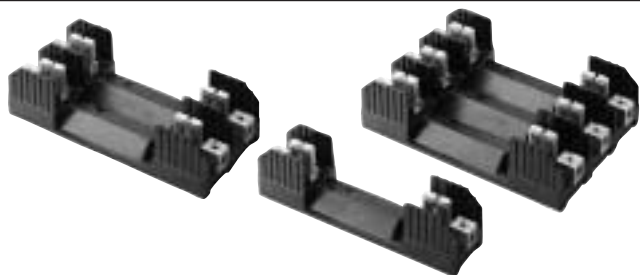

H250 Series For use with Class H Fuses
(Bussmann NON and REN).

R250 Series For use with Class R Fuses
(Bussmann LPN-RK and FRN-R, DLN-R and KTN-R).

Construction: Thermoplastic, UL Flammability: 94VO

Ampere Ratings: 1/10-600A.

Withstand Ratings: H250 Series - 10,000A RMS Sym.;
R250 Series - 200,000A RMS Sym.

Voltage Rating: H250, 250V; R250, 250V

Agency Information: UL Listed UL512, Guide IZLT,
File E14853; CSA Certified, Class 6225-01, File 47235

Class H Fuseblocks (250V) Catalog Data (for NON and REN Fuses)

Amps	Poles	Basic Catalog Number	Terminal Type (Suffix No.)										Fig. No.	Dimensions (Inches) – See Next Page For Figures										Wire Range
			Screw					Box Lug w/						A	B	C	D	E	F	G	H	J Dia. x C' Bore	K	
			Clip with Reinforced Spring	Pressure Plate	Pressure Plate & Clip with Reinforced Spring	Clip with Reinforced Spring	Clip w/ Reinforced Spring (Copper Only)	Copper Only	0.25" Quick Connect															
1/10 to 30	1	H25030-1	S	SR	P	PR	C	CR	COR	CO	Q	1	(See Figures)										C, CR #2-14 CU, #2-12 AL CO, COR #6-14 CU ONLY P, PR #10-18 CU ONLY Q N/A S, SR #10-18 CU ONLY	
	2	H25030-2	S	SR	P	PR	C	CR	COR	CO	Q	2	(See Figures)											
	3	H25030-3	S	SR	P	PR	C	CR	COR	CO	Q	3	(See Figures)											
31 to 60	1	H25060-1	—	—	—	—	C	CR	COR	CO	—	4	4.25	1.73	1.5	1.5	0.5	0.5	1.25	—	0.22 x 0.41	0.27	C, CR #2-14 CU, #2-8 AL CO, COR #2-14 CU ONLY	
	2	H25060-2	—	—	—	—	C	CR	COR	CO	—	5			2.81					1.31				
	3	H25060-3	—	—	—	—	C	CR	COR	CO	—	6			4.125					1.31				
61 to 100	1	H25100-1	—	SR	—	—	—	CR	COR	—	—	7	(See Figures)										COR #1/0-8 CU ONLY CR #1/0-8 CU/AL SR #8W/ Ring Terminal	
	2	H25100-2	—	SR	—	—	—	CR	COR	—	—	8	(See Figures)											
	3	H25100-3	—	SR	—	—	—	CR	COR	—	—	9	(See Figures)											
101 to 200	1	H25200-1	—	—	—	—	—	CR	—	—	—	10	7.125	3.09	3.0	2.06	0.5	2.0	3.0	0.75	—	0.31	CR 250kcmil-6 CU/AL	
	3	H25200-3	—	—	—	—	—	CR	—	—	—	11	(See Figures)											
201 to 400	1	H25400-1	—	—	—	—	—	CR†	—	—	—	10	9.06	4.0	3.0	3.02	0.63	1.75	3.0	1.0	—	0.31	CR 500kcmil-4 CU/AL	
	3	H25400-3	—	—	—	—	—	CR†	—	—	—	12	9.06	4.0	4.0	2.50	0.82	9.25	10.88	1.0	—	0.31		
401 to 600	1	H25600-1	—	—	—	—	—	CR	—	—	—	10	11.0	4.97	3.0	4.0	1.125	1.75	4.0	1.00	—	0.31	CR (2) 500kcmil-4/0 CU/AL	
	3	H25600-3	—	—	—	—	—	CR†	—	—	—	12	11.0	4.97	5.0	3.0	1.87	11.0	14.74	1.00	—	0.31		

*UL Recognized, CSA Certification.

†No UL, No CSA Certification.



Class H(K) and R Fuseblocks – 250V

Class R Fuseblocks (250V) Catalog Data (for LPN-RK, FRN-R, DLN-R and KTN-R Fuses)

Amps	Poles	Basic Catalog Number	Terminal Type (Suffix No.)					Fig. No.	Dimensions (Inches)											Wire Range
			Screw w/		Box Lug w/		0.25" Quick-Connect		A	B	C	D	E	F	G	H	J Dia. x C' Bore	K		
			—	Pres. Plate	—	Clip Cu Only														
1/10 to 30	1	R25030-1	SR	PR	CR	COR	QR*	1	(See Figures)											COR #6-14 CU ONLY CR #2-14 CU, #2-12 AL PR #10-18 CU ONLY QR N/A SR #10-18 CU ONLY
	2	R25030-2	SR	PR	CR	COR	QR*	2	(See Figures)											
	3	R25030-3	SR	PR	CR	COR	QR*	3	(See Figures)											
31 to 60	1	R25060-1	—	—	CR	COR	—	4	4.25	1.73	1.5	1.5	0.5	0.5	1.25	—	0.22 x 0.41	0.27	COR #2-14 CU ONLY CR #2-14 CU, #2-8 AL	
	2	R25060-2	—	—	CR	COR	—	5			2.81					1.31				
	3	R25060-3	—	—	CR	COR	—	6	4.125	1.31										
61 to 100	1	R25100-1	—	—	CR	COR	—	7	(See Figures)											COR 1/0-8 CU ONLY CR 1/0-8 CU/AL
	2	R25100-2	—	—	CR	COR	—	8	(See Figures)											
	3	R25100-3	—	—	CR	COR	—	9	(See Figures)											
101 to 200	1	R25200-1	—	—	CR	—	—	10	7.125	3.15	3.0	2.06	0.5	2.0	3.0	0.75	—	0.31	CR 250kcmil-6 CU/AL	
	3	R25200-3	—	—	CR	—	—	11	(See Figure)											
201 to 400	1	R25400-1	—	—	CR†	COR‡	—	10	9.06	4.0	3.0	3.02	0.91	1.75	3.0	1.0	—	0.56	COR 500kcmil-4/0 CU ONLY CR 500kcmil-4 CU/AL	
	3	R25400-3	—	—	CR†	COR†	—	12	9.06	4.0	4.0	2.5	0.82	9.25	10.88	1.0				
401 to 600	1	R25600-1	—	—	CR	—	—	10	11.0	4.97	3.0	4.0	1.125	1.75	4.0	1.0	—	0.56	CR (2) 500kcmil-4/0 CU/AL	
	3	R25600-3	—	—	CR†	—	—	12	11.0	4.97	5.0	3.0	1.87	11.0	14.74	1.0				

*UL Recognized, No CSA Certification.
 †No UL, No CSA Certification.
 ‡UL Recognized, CSA Certification

CE CE logo denotes compliance with European Union Low Voltage Directive (50-1000Vac, 75-1500Vdc). Refer to Data Sheet: 8002 or contact Bussmann Application Engineering at 314-527-1270 for more information.

Dimensional Data 250V 1/10A to 30A

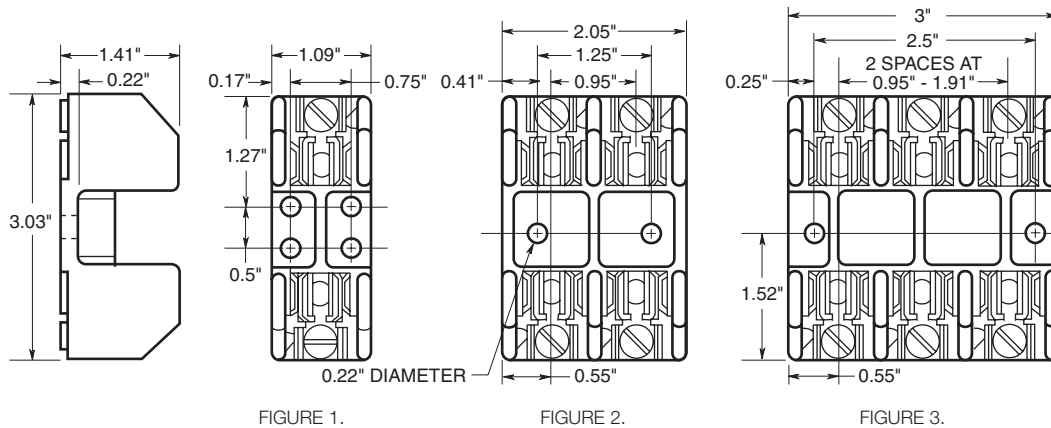

Class H(K) and R Fuseblocks – 250V

250V, 31A to 60A

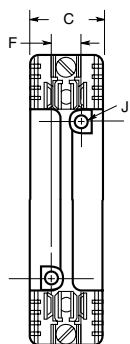
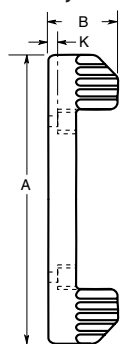

FIGURE 4.

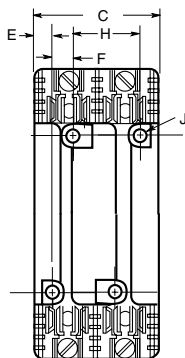

FIGURE 5.

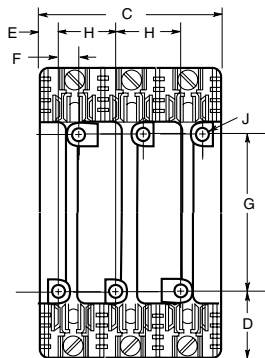

FIGURE 6.

250V, 61A to 100A

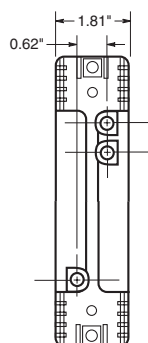
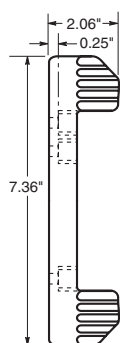

FIGURE 7.

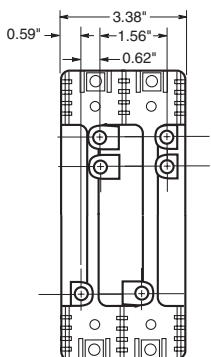

FIGURE 8.

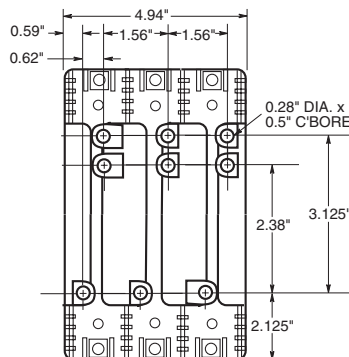

FIGURE 9.

250V, 101A to 600A

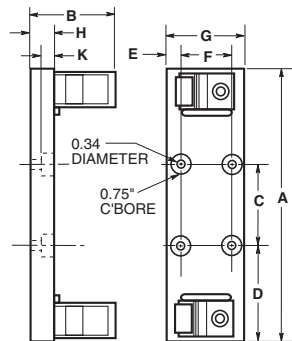

FIGURE 10.

250V, 101A to 200A

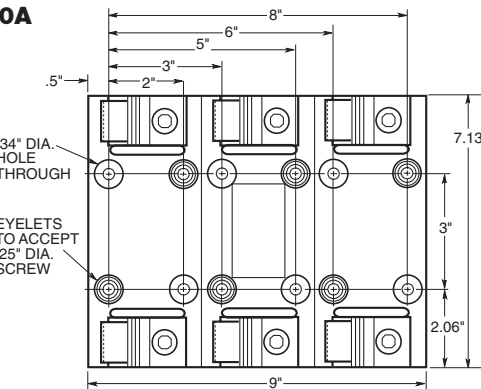
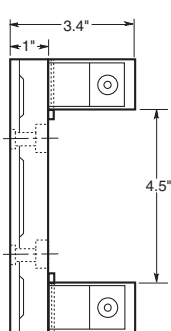

FIGURE 11.

250V, 201A to 600A

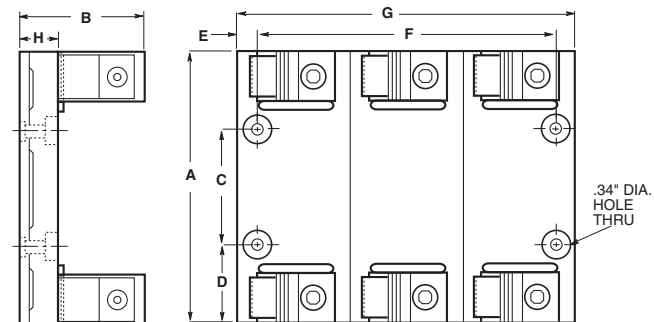
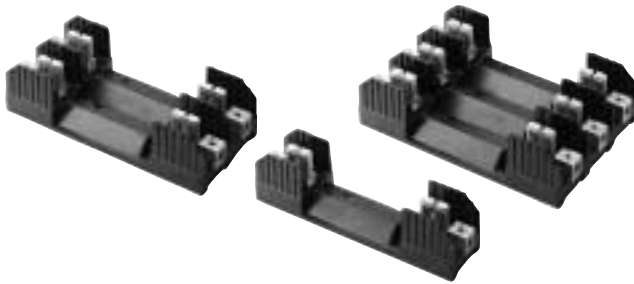

FIGURE 12.



Class H(K) and R Fuseblocks – 600V



H600 Series For use with Class H Fuses
(Bussmann NOS and RES).

R600 Series For use with Class R Fuses
(Bussmann LPS-RK, FRS-R, DLS-R and KTS-R).

Construction: Thermoplastic, UL Flammability: 94VO

Ampere Ratings: 1/10-600A

Withstand Ratings: H600Series - 10,000A RMS Sym.;
R600 Series - 200,000A RMS Sym.

Voltage Rating: H600, 600V; R600, 600V

Agency Information: UL Listed UL512, Guide IZLT, File E14853; CSA Certified, Class 6225-01, File 47235

Class H Fuseblocks (600V) Catalog Data (for NOS and RES Fuses)

Amps	Poles	Basic Catalog Number	Terminal Type (Suffix No.)								Dimensions (Inches) – See Next Page For Figures											Wire Range		
			Screw				Box Lug w/				Fig. No.	A	B	C	D	E	F	G	H	J Dia. x C' Bore	K			
			Clip with Reinforced Spring	Pressure Plate	Pressure Plate & Clip with Reinforced Spring	Clip with Reinforced Spring	Clip w/ Reinforced Spring (Copper Only)	Copper Only	0.25" Quick Connect															
1/10 to 30	1	H60030-1	S	SR	P	PR	C	CR	COR	CO	—	1	6.25	1.73	1.54	1.56	.25	0.62	3.13	1.56	0.28 x 0.5	.26	C, CR #2-14 CU, #2-12 AL CO, COR #6-14 CU ONLY P, PR, S, SR #10-18 CU ONLY	
	2	H60030-2	S	SR	P	PR	C	CR	COR	CO	—	2			2.90									
	3	H60030-3	S	SR	P	PR	C	CR	COR	CO	—	3			4.25									
31 to 60	1	H60060-1	—	—	—	—	C	CR	COR	CO	—	4	(See Figures)											C, CR #2-14 CU, #2-8 AL CO, COR #4-14 CU ONLY
	2	H60060-2	—	—	—	—	C	CR	COR	CO	—	5	(See Figures)											
	3	H60060-3	—	—	—	—	C	CR	COR	CO	—	6	(See Figures)											
61 to 100	1	H60100-1	—	SR†	—	—	—	CR	COR	—	—	1	9.5	2.38	2.22	2.63	0.67	0.88	4.25	1.81	0.28 x 0.50	.34	COR 1/0-8 CU ONLY CR 1/0-8 CU/AL SR #8w/ Ring Terminal	
	2	H60100-2	—	SR†	—	—	—	CR	COR	—	—	2			4.03									
	3	H60100-3	—	SR†	—	—	—	CR	COR	—	—	3			5.84									
101 to 200	1	H60200-1	—	—	—	—	—	CR	—	—	—	7	9.63	3.09	3.0	3.31	0.5	2.0	3.0	0.75	—	0.31	CR 250kcmil-6 CU/AL	
	3	H60200-3	—	—	—	—	—	CR	—	—	—	8	(See Figures)											
201 to 400	1	H60400-1	—	—	—	—	—	CR†	COR†	—	—	7	12.0	4.0	3.0	4.5	0.63	1.75	3.0	1.0	—	0.56	COR 500kcmil-4/0 CU ONLY CR 500kcmil-4 CU/AL	
	3	H60400-3	—	—	—	—	—	CR†	—	—	—	9	(See Figures)											
401 to 600	1	H60600-1	—	—	—	—	—	CR	—	—	—	7	14.0	4.97	3.0	5.5	1.125	1.75	4.0	1.0	—	0.56	CR 500kcmil-4/0 CU/AL	
	3	H60600-3	—	—	—	—	—	CR†	—	—	—	10	(See Figures)											

†No UL, No CSA Certification.

‡UL Recognized, CSA Certification

CE logo denotes compliance with European Union Low Voltage Directive (50-1000Vac, 75-1500Vdc). Refer to Data Sheet #8002 or contact Bussmann Application Engineering at 636-527-1270 for more information.



Class H(K) and R Fuseblocks – 600V

Class R Fuseblocks (600V) Catalog Data (for LPS-RK, FRS-R, DLS-R and KTS-R Fuses)

Amps	Poles	Basic Catalog Number	Terminal Type (Suffix No.)					Dimensions (Inches)										Wire Range	
			Screw w/		Box Lug w/		0.25" Quick-Connect	Fig. No.	A	B	C	D	E	F	G	H	J Dia. x C' Bore		K
			—	Pres. Plate	—	Clip Cu Only													
1/10	1	R60030-1	SR	PR	CR	COR	—	1	6.25	1.73	1.54	1.56	0.25	0.62	3.13	1.56	0.28 x 0.5	.26	COR #6-14 CU ONLY CR #2-14 CU, #2-12 AL PR, SR #10-18 CU ONLY
	2	R60030-2	SR	PR	CR	COR	—	2			2.90								
	3	R60030-3	SR	PR	CR	COR	—	3			4.25								
31	1	R60060-1	—	—	CR	COR	—	4	(See Figures)										COR #2-14 CU ONLY CR #2-14 CU, #2-8 AL
	2	R60060-2	—	—	CR	COR	—	5											
	3	R60060-3	—	—	CR	COR	—	6											
61	1	R60100-1	—	—	CR	COR	—	1	9.5	2.38	2.22	2.63	0.67	0.88	4.25	1.81	0.28 x 0.5	0.34	COR 1/0-8 CU ONLY CR, CRQ 1/0-8 CU/AL
	2	R60100-2	—	—	CR	COR	—	2			4.03								
	3	R60100-3	—	—	CR	COR	CRQ†	3			5.84								
101	1	R60200-1	—	—	CR	—	CRQ†	7	9.63	3.09	3.0	3.31	0.5	2.0	3.0	0.75	—	0.31	CR, CRQ 250kcmil-6 CU/AL
	3	R60200-3	—	—	CR	—	—	8	(See Figures)										
201	1	R60400-1	—	—	CR‡	COR‡	—	7	12.0	4.0	3.0	4.5	0.63	1.75	3.0	1.0	—	0.56	COR 500kcmil-4/0 CU ONLY CR 500kcmil-4 CU/AL
	3	R60400-3	—	—	CR†	—	—	9	(See Figures)										
401	1	R60600-1	—	—	CR	—	—	7	14.0	4.97	3.0	5.5	1.125	1.75	4.0	1.0	—	0.56	CR (2) 500kcmil-4/0 CU/AL
	3	R60600-3	—	—	CR†	—	—	10	(See Figures)										

†No UL, No CSA Certification.

‡UL Recognized, CSA Certification

CE CE logo denotes compliance with European Union Low Voltage Directive (50-1000 Vac, 75-1500 Vdc). Refer to Data Sheet: 8002 or contact Bussmann Application Engineering at 314-527-1270 for more information.

Dimensional Data

600V, 1/10 to 30A
and 61A to 100A

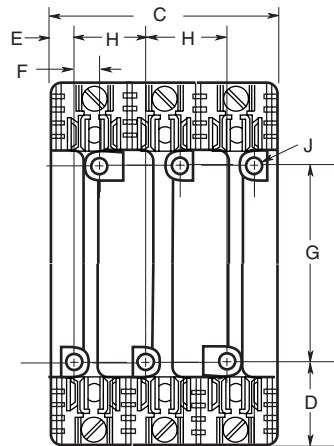
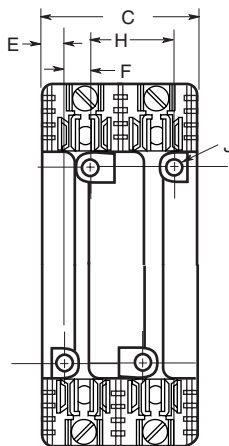
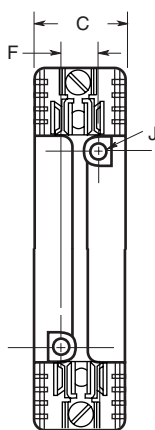
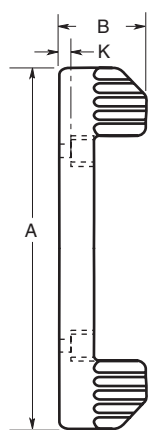

FIGURE 1.

FIGURE 2.

FIGURE 3.



Class H(K) and R Fuseblocks – 600V

Dimensional Data

600V, 31A to 60A

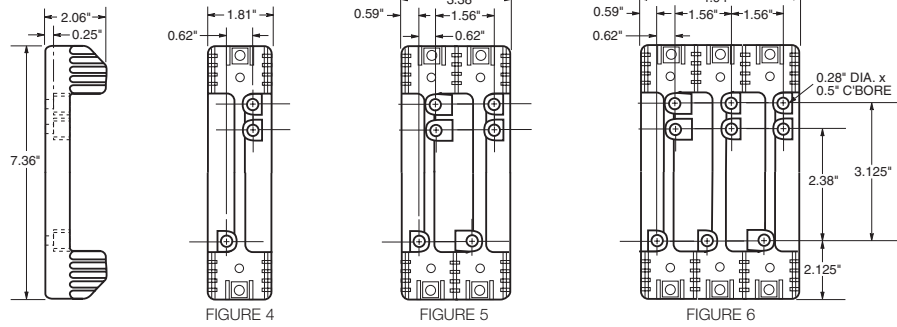

600V, 101A to 600A

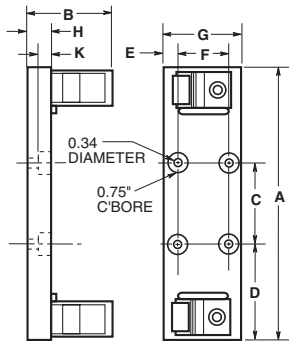

FIGURE 7

600V, 101A to 200A

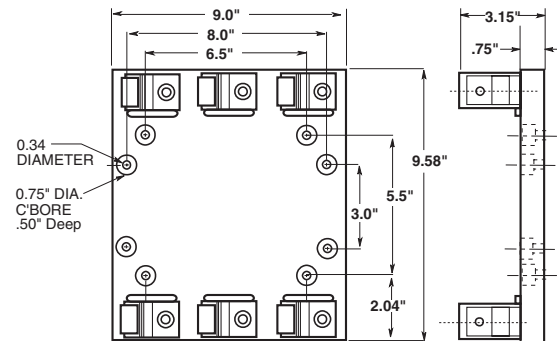

FIGURE 8

600V, 201A to 400A

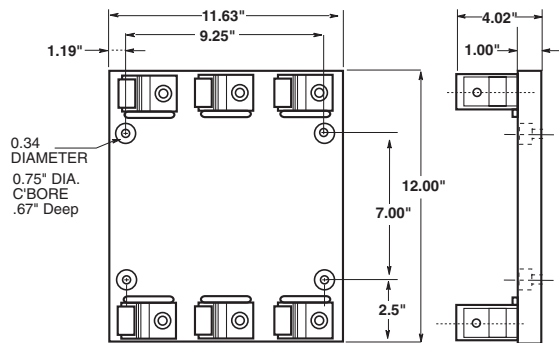

FIGURE 9

600V, 401A to 600A

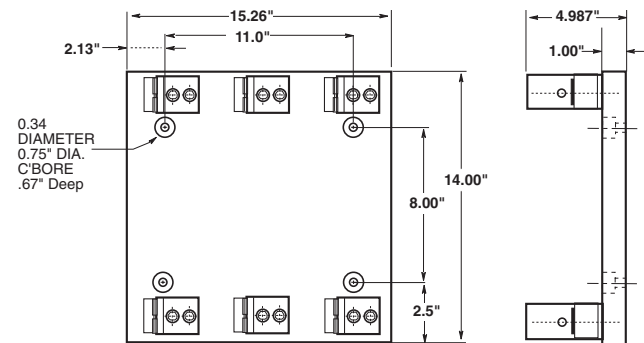

FIGURE 10



Class J Fuseblocks



J600 Series For use with Class J Fuses (Bussmann® LPJ and JKS).

Catalog Symbol: J600 Series

Ampere Rating: ½-600A

Voltage Rating: 600V

Withstand Rating: 200,000 RMS Sym. Amps

Agency Information:

UL Listed, UL 512, Guide IZLT, File E14853

CSA Certified, C22.2 No. 39, Class 6225-01, File 47235

Materials: Thermoplastic

UL Flammability: UL 94V0

Standard J Fuseblocks (600V) Catalog Data

Amps	Poles	Catalog Numbers				Fig. No.	Wire Range
		Screw†	Pressure Plate†	Box Lug	Box Lug w/ Retaining Clip		
½-30	1	J60030-1S ⁽²⁾	J60030-1P	J60030-1C	J60030-1CR††	1	C, CR #2-14 CU, #2-8 AL
	2	J60030-2S ⁽²⁾	J60030-2P	J60030-2C	J60030-2CR††	2	COR #2-14 CU ONLY
	3	J60030-3S ⁽²⁾	J60030-3P	J60030-3C	J60030-3CR††	3	P, PR, S, SR #10-14 CU ONLY
31-60	1	—	—	J60060-1C	J60060-1CR††	1	C, CR, #2-14 CU/AL
	2	—	—	J60060-2C	J60060-2CR††	2	COR #4-14 CU ONLY
	3	—	—	J60060-3C	J60060-3CR††	3	
61-100	1	—	—	—	J60100-1CR	4	COR 1/0-8 CU ONLY
	3	—	—	—	J60100-3CR††	5	CR, CRQ 1/0-8 CU/AL
101-200	1	—	—	—	J60200-1CR	6	CR 250kcmil-6 CU/AL
	3	—	—	—	J60200-3CR	7	
201-400	1	—	—	—	J60400-1CR ⁽³⁾	8	CR 500kcmil -4 CU/AL
	3	—	—	—	J60400-3CR ⁽²⁾	9	
401-600	1	—	—	—	J60600-1CR	10	CR (2) 500kcmil-4/0 CU/AL
	3	—	—	—	J60600-3CR	11	

†Clip reinforcing springs are standard on fuseblocks rated 100A and above. Available on 30A and 60A blocks by adding the letter "R" to the end of the part number.

††Copper only connections available by changing "CR" suffix to "COR".

(2)No UL, No CSA Certification

(3)UL Recognized, CSA Certification

CE logo denotes compliance with European Union Low Voltage Directive (50-1000 Vac, 75-1500 Vdc). Refer to Data Sheet: 8002 or contact Bussmann Application Engineering at 636-527-1270 for more information.

Dimensional Data All dimensions (±0.015)

½-60A

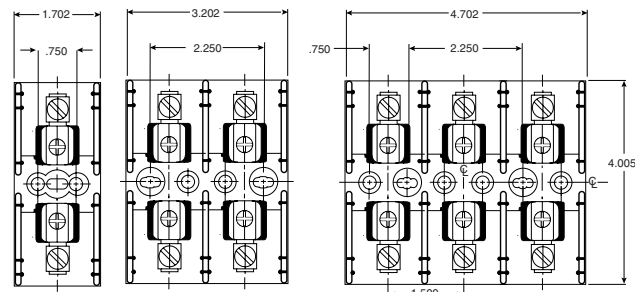

FIGURE 1.

FIGURE 2.

FIGURE 3.

61-100A

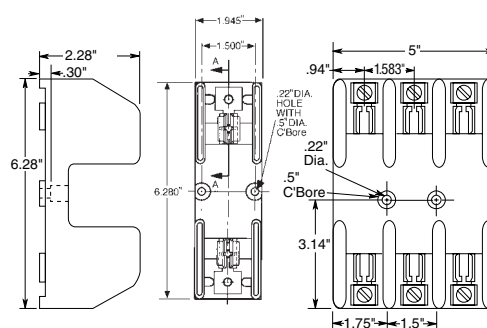

FIGURE 4.

FIGURE 5.



Class J Fuseblocks

101-200A

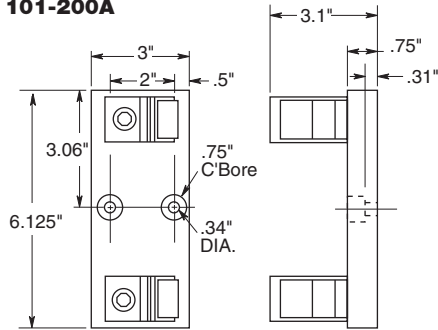

FIGURE 6.

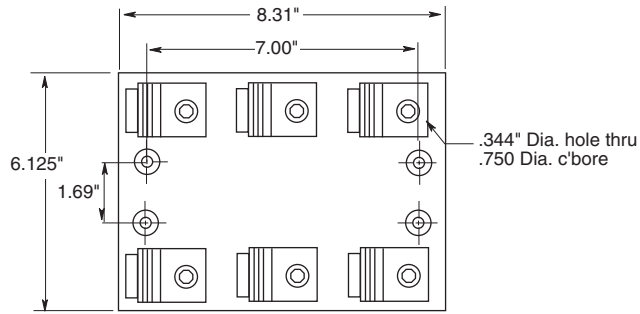
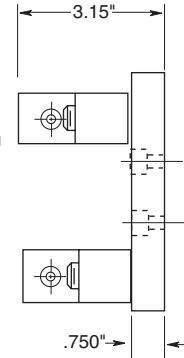

FIGURE 7.



201-400A

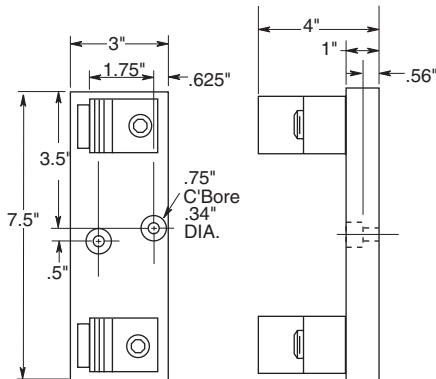

FIGURE 8.

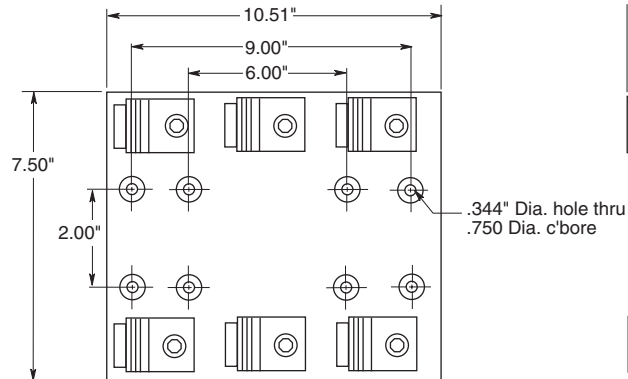
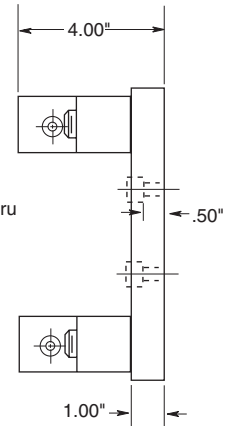

FIGURE 9.



401-600A

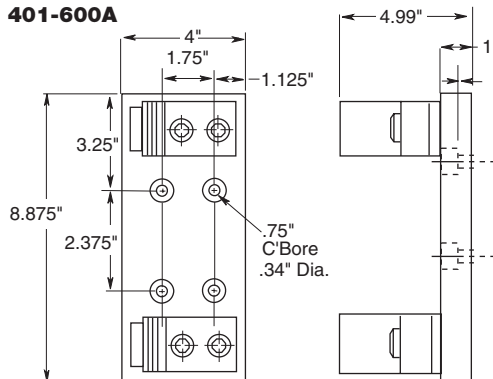

FIGURE 10.

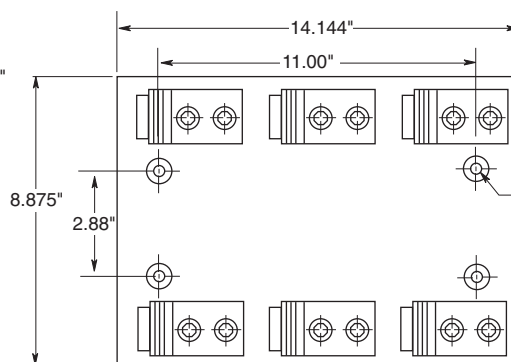
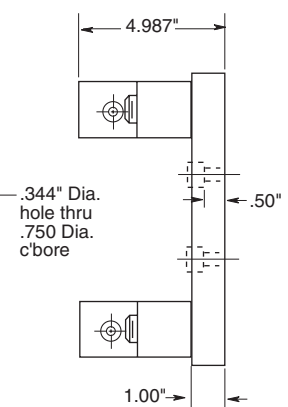

FIGURE 11.



Class J Fuseblocks



JP Series For use with Class J Fuses
(Bussmann LPJ,JKS).

Pyramid Style Fuseblock

Ampere Rating: 30A

Voltage Rating: 600V

Withstand Rating: 200,000 RMS Sym. Amps

Agency Information:

UL Listed, U.L. 512, Guide IZLT, File E14853

CSA Certified, C22.2 No. 39, Class 4225-04, File 47235

Material: Thermoplastic

UL Flammability: UL 94V0

CE logo denotes compliance with European Union Low Voltage Directive (50-1000 Vac, 75-1500 Vdc). Refer to Data Sheet: 8002 or contact Bussmann Application Engineering at 314-527-1270 for more information.

Pyramid® J Fuseblock; 30A, 600V; 3-Pole; Panel or 35mm DIN-Rail Mount; Clips with Reinforcing Springs

Mounting	Catalog Numbers		
	Screws with Pressure Plate	Box	
		Aluminum	Copper Only
Panel	JP60030-3PR (#10-14 CU ONLY)	JP60030-3CR (#2-14 CU/AL)	JP60030-3COR (#2-14 CU ONLY)
With DIN-Rail Adapter*	JP60030-3PRA (#10-14 CU ONLY)	JP60030-3CRA (#2-14 CU/AL)	JP60030-CORA (#2-14 CU ONLY)

*Adapter Only for DIN-Rail - Cat No. JPA-3.

Dimensional Data

*All other dimensions ($\pm 0.015"$)
($\pm 0.40\text{mm}$)

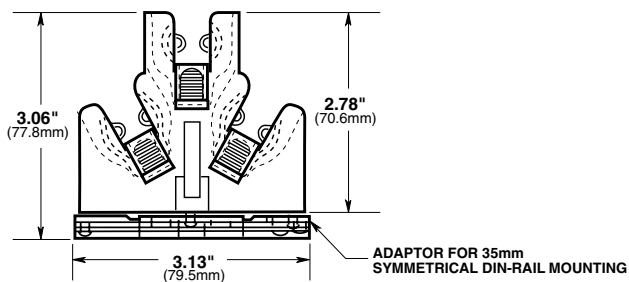
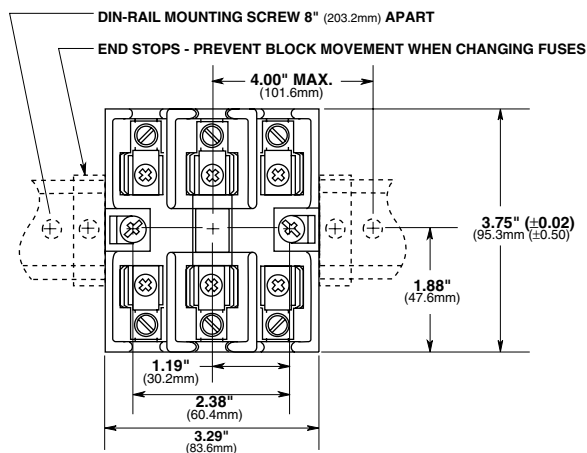

Semiconductor Fuseblocks



J70100

Ampere Rating: 100A

Voltage Rating: 700V

Agency Information:

UL Recognized, Guide IZLT2, File E14853

Withstand Rating: 200,000 RMS Sym. Amps

For use with 22 × 58mm fuses
(FWP-40A22F, FWP-100A22F, etc.)

Materials: Thermoplastic

UL Flammability: UL 94V0

Amps	Poles	Catalog Numbers		
		Box Lug w/ Retaining Clip	Fig. No.	Wire Range
100	1	J70100-1CR	1	#2-14 CU/AL
	2	J70100-2CR	2	#2-14 CU/AL
	3	J70100-3CR	3	#2-14 CU/AL

Dimensional Data
100A

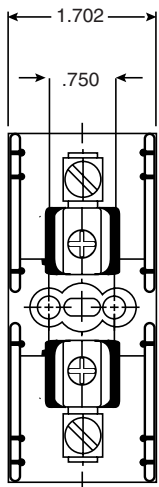

FIGURE 1

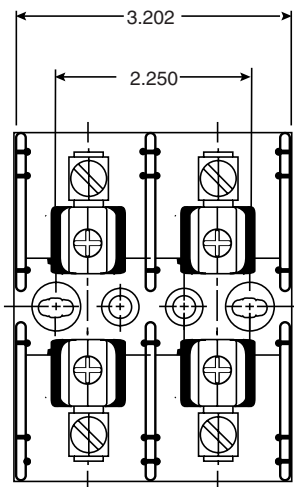

FIGURE 2

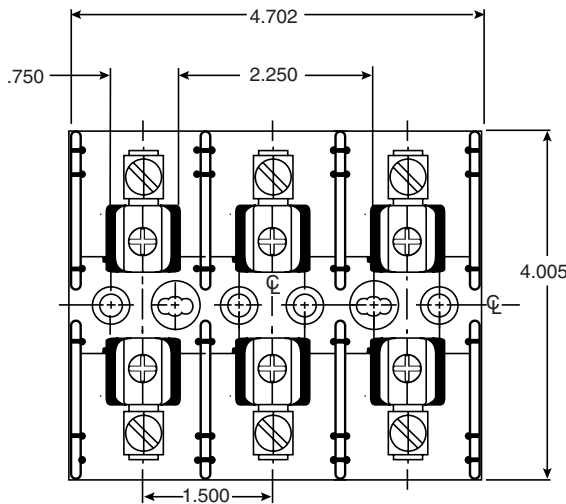
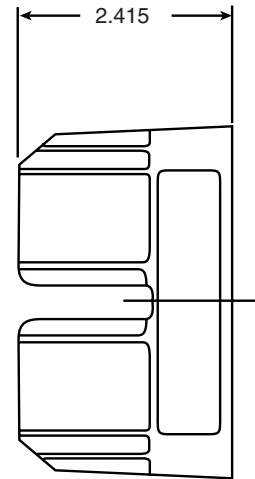

FIGURE 3



Class J (Finger-Safe) Fuseholders

Safety J



JT(N)60030 and JT(N)60060

For use with Bussmann Class "J" fuses - (Bussmann LPJ, JKS)

Catalog Numbers:

JT60030 and JT60060 - Non-Indicating

JTN60030 and JTN60060 - Indicating (Neon)

Construction: Thermoplastic, UL Flammability; 94VO

Voltage Ratings: 600V

Amperage Rating: JT(N)60030 - 30A,

JT(N)60060 - 60A

Withstand Rating: 200,000A RMS Sym.

(Self Certified at 300,000A using Bussmann LPJ_SP fuses)

Agency Information:

Listed to UL 512: Guide IZLT, File 14853

CSA Certified: Class 6225-01, File 47235

Indication: Min. voltage: 90 VAC, 115 VDC; Neon Lamp "ON" when fuse opens, voltage source and current path are present.

Finger-Safe: IP20 per IEC 60529

Terminations: 30A Dual Port Torque 20 lb. in., 60A Single Port Torque 45 lb. in., Terminal Construction, Tin plated Copper Alloy

Wire Size: JT(N)60030 - Rated for 75°C, AWG#18-#8; CU only, JT(N)60060 - Rated for 75°C, AWG#14-#4; CU only.

(Note: For JT(N)60030 use both stranded or solid, in a variety of dual wire combinations of same wire size and type.)

Packaging: 12 in a carton

CE CE logo denotes compliance with European Union Low Voltage Directive (50-1000Vac, 75-1500Vdc). Refer to Data Sheet: 8002 or contact Bussmann Application Engineering at 636-527-1270 for more information.

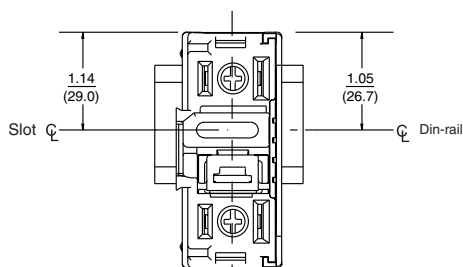

MOUNTING
Shown without fuse pullout cover

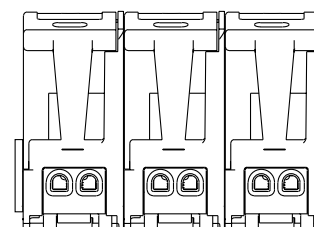
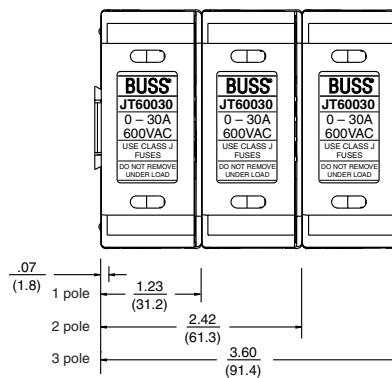
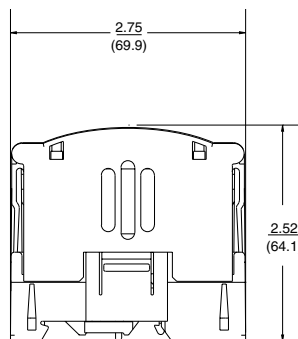

Dim. = $\frac{\text{in.}}{\text{(mm.)}}$

JT60030
JTN60030



Class J (Finger-Safe) Fuseholders



JT(N)600 Series fuseblocks can be dovetailed together within the same current rating to provide multiple pole block configurations.

NOTE: JT(N)60030 cannot be dovetailed to JT(N)60060.

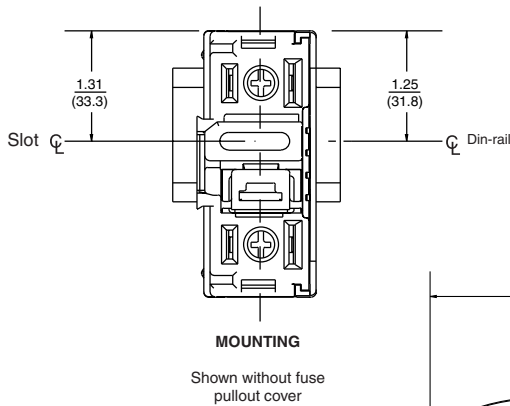

Dim. = $\frac{\text{in.}}{\text{(mm.)}}$

JT60060
JTN60060

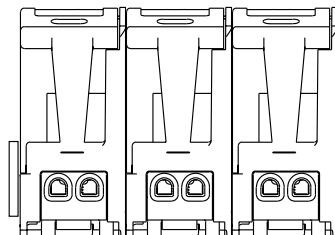
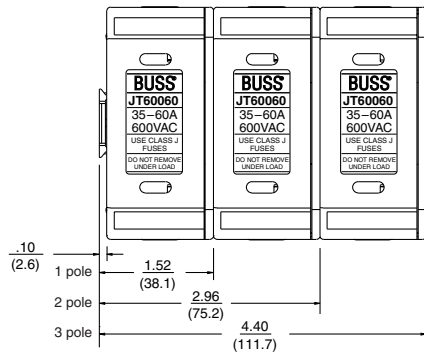
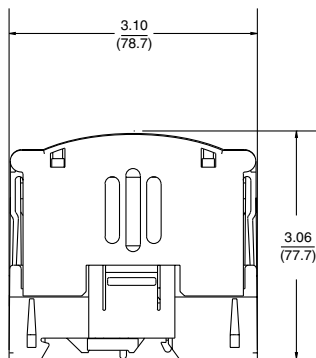

Class T Fuseblocks – 300V



T300 (300V) For use with Class T Fuses
(Bussmann JJN)

Construction: Glass Polyester, Phenolic on 600A,
UL Flammability: 94VO

Rating: ½-600A

Withstand Rating: 200,000A RMS Sym.

Agency Information:

UL Listed UL512, Guide IZLT, File E14853
CSA Certified, Class 6225-01, File 47235.

CE logo denotes compliance with European Union Low Voltage Directive (50-1000Vac, 75-1500Vdc). Refer to Data Sheet: 8002 or contact Bussmann Application Engineering at 636-527-1270 for more information.

Class T Fuseblocks (300V) Catalog Data

Amps	Poles	Catalog Numbers		Fig. No.	Wire Range
		Screw	Box Lug		
½-30	2	T30030-2SR	T30030-2CR	1	SR #10-18 CU CR #6-14 CU-AL
	3	T30030-3SR	T30030-3CR		
	4	T30030-4SR	T30030-4CR		
31-60	2	T30060-2SR	T30060-2CR	1	CR #2-14 CU-AL SR #10-18 CU ONLY
	3	T30060-3SR	T30060-3CR		
	4	T30060-4SR	T30060-4CR		
61-100	1	—	T30100-1CR	2	1/0-8 CU-AL
	2	—	T30100-2CR		
	3	—	T30100-3CR		
101-200	1	—	T30200-1C	3	250kcmil-6 CU-AL
	3	—	T30200-3C		
201-400	1	—	T30400-1C	5	600kcmil-2/0 CU-AL
401-600	1	—	T30600-1C	6 (2)	600kcmil-4/0 CU-AL

Dimensional Data

Figure 1. ½A to 60A

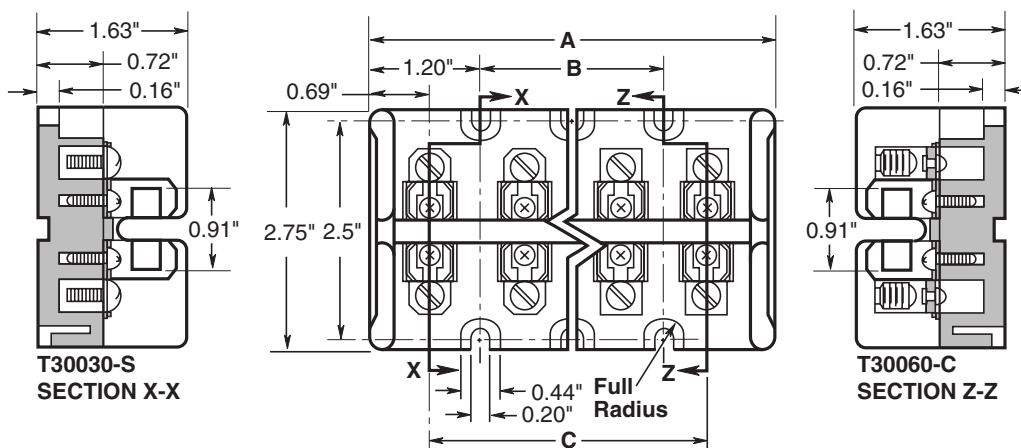

Class T Fuseblocks (300V) Catalog Numbers

Block Type	Dimensions (Inches)		
	A	B	C
T30030-2 T30060-2	2.41	—	1.03
T30030-3 T30060-3	3.44	1.03	2.06
T30030-4 T30060-4	4.47	2.06	3.09



Class T Fuseblocks - 300V

Figure 2. 61A to 100A

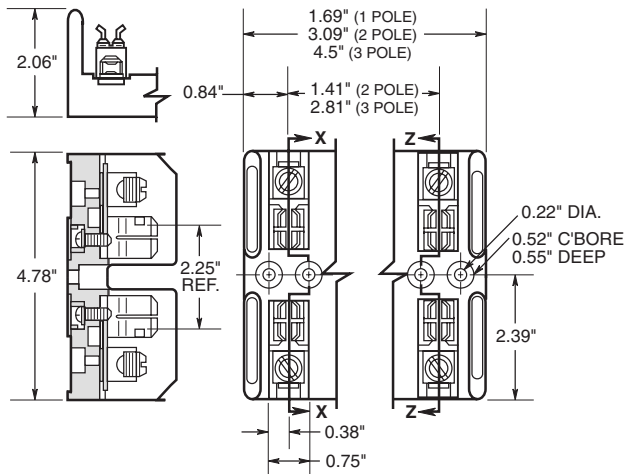

Figure 3. 101A to 200A

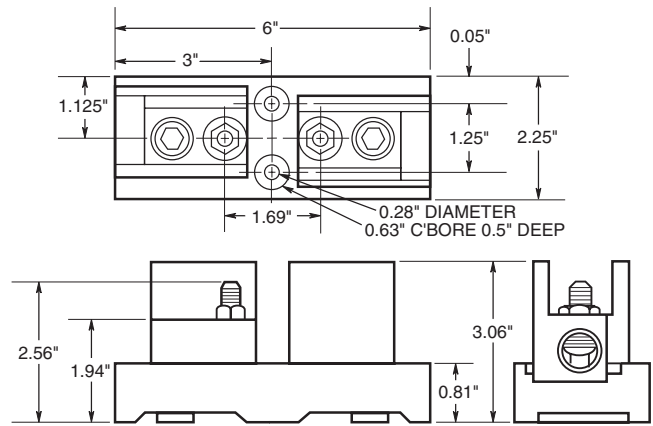

Figure 4. 200A

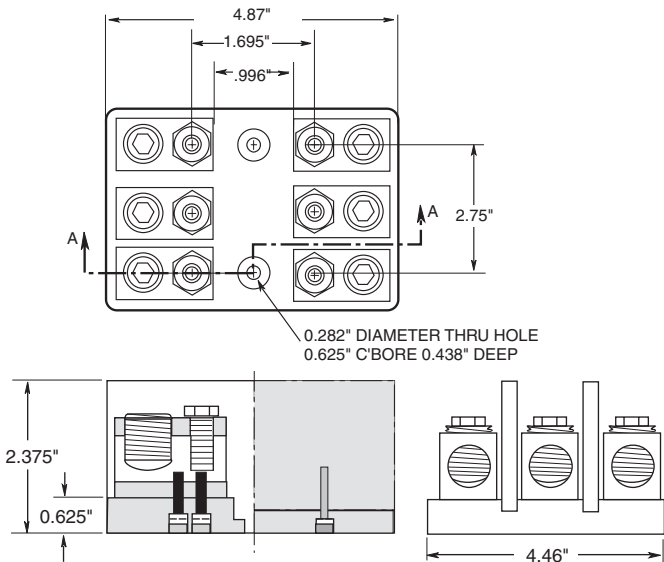

Figure 5. 201A to 400A

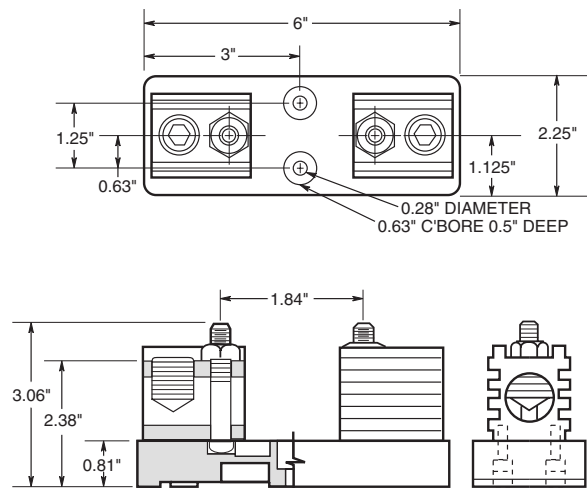
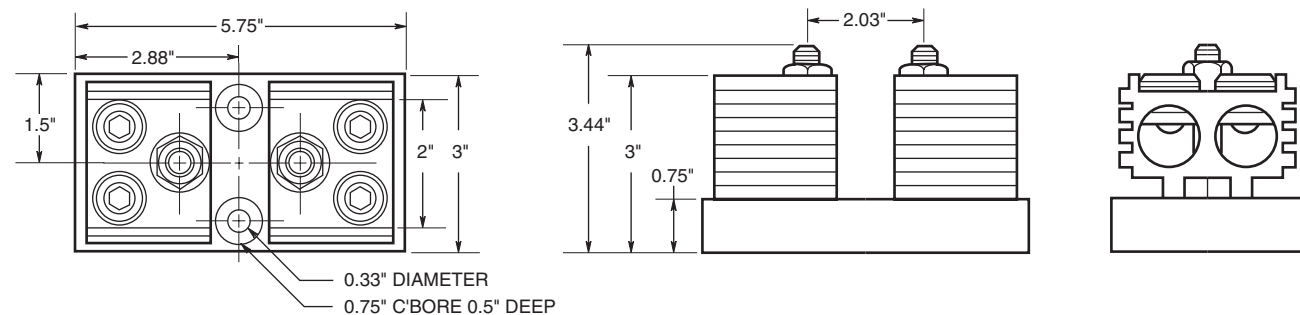

Figure 6. 401A to 600A



Data Sheet: 1115



Class T Fuseblocks - 600V



T600 (600V) For use with Class T Fuses
(Bussmann JJS)

Construction: Glass Polyester, Phenolic on 600A,
UL Flammability: 94VO

Rating: ½-600A

Withstand Rating: 200,000A RMS Sym.

Agency Information:

UL Listed UL512, Guide IZLT, File E14853
CSA Certified, Class 6225-01, File 47235.

CE CE logo denotes compliance with European Union Low Voltage Directive (50-1000Vac, 75-1500Vdc). Refer to Data Sheet: 8002 or contact Bussmann Application Engineering at 636-527-1270 for more information.

Class T Fuseblocks (600V) Catalog Data

Amps	Poles	Catalog Numbers		Fig. No.	Wire Range
		Screw	Box Lug		
½-30	1	T60030-1SR	T60030-1CR	1	SR #10-18 CU CR #2-14 CU-AL
	2	T60030-2SR	T60030-2CR		
	3	T60030-3SR	T60030-3CR		
31-60	1	T60060-1SR	T60060-1CR	2	CR #2-14 CU-AL SR #10-18 CU ONLY
	2	T60060-2SR	T60060-2CR		
	3	T60060-3SR	T60060-3CR		
61-100	1	—	T60100-1C	3	2/0-14 CU-AL
	2	—	T60100-2C		
	3	—	T60100-3C		
101-200	1	—	T60200-1C	4	250kcmil-6 CU-AL
	3	—	1B0089*		
201-400	1	—	T60400-1C	5	600kcmil-2/0 CU-AL
401-600	1	—	T60600-1C	6	(2) 600kcmil-4/0 CU-AL

* UL Listed, Guide IZLT, File E14853,
CSA Certified Class 6225-01, File 21455M18

Figure 1. ½A to 30A

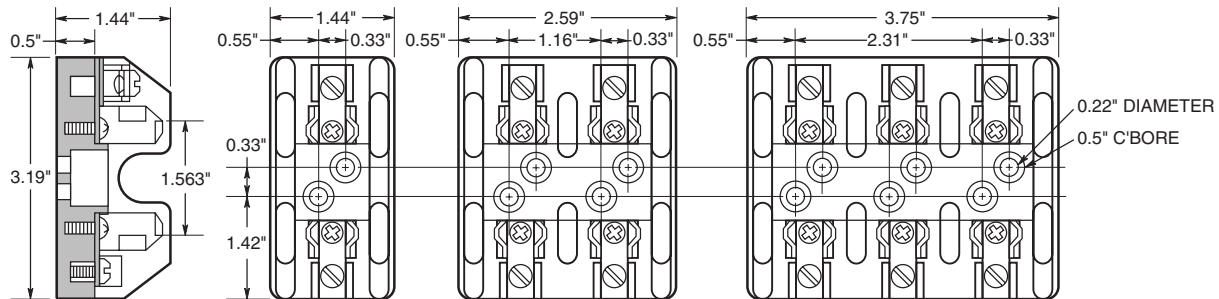
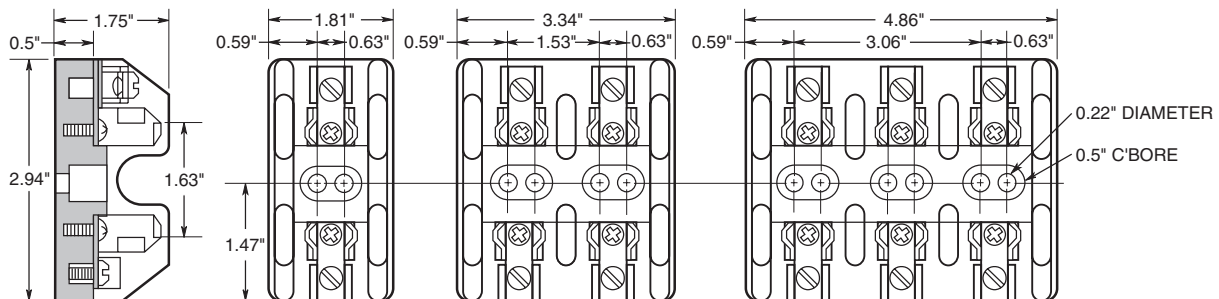

Figure 2. 31A to 60A



Class T Fuseblocks - 600V

Figure 3. 61A to 100A

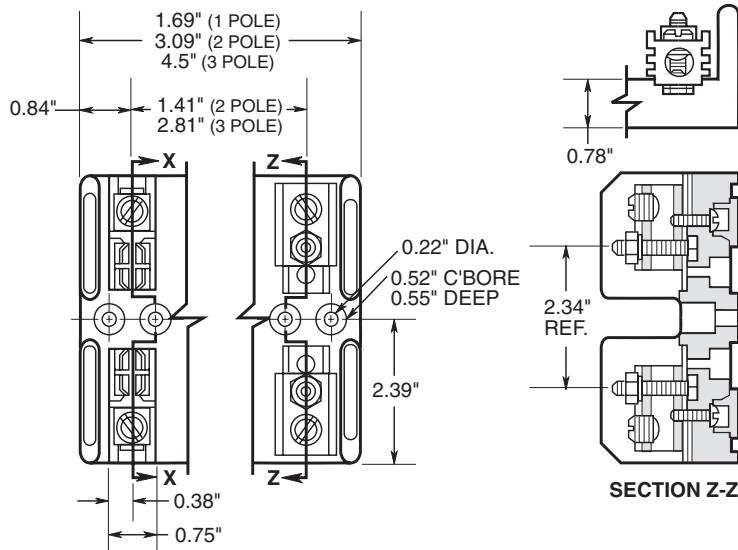

Figure 4. 101A to 200A

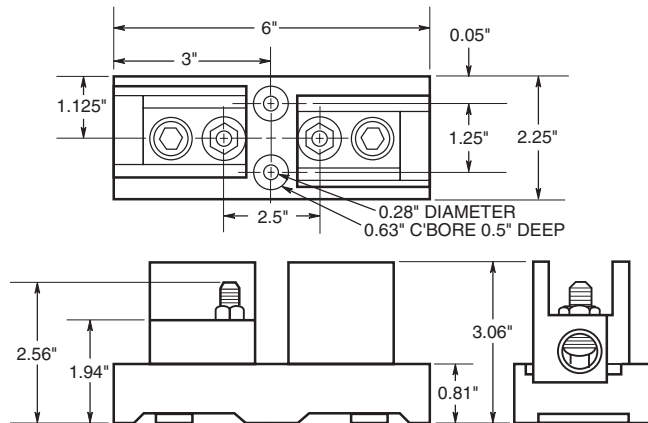

Figure 5. 201A to 400A

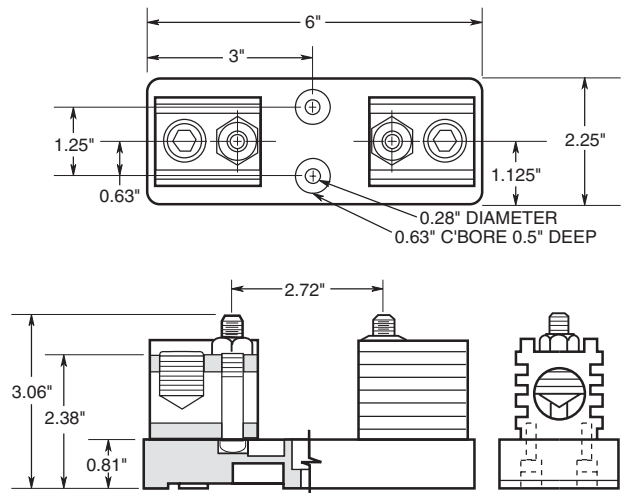
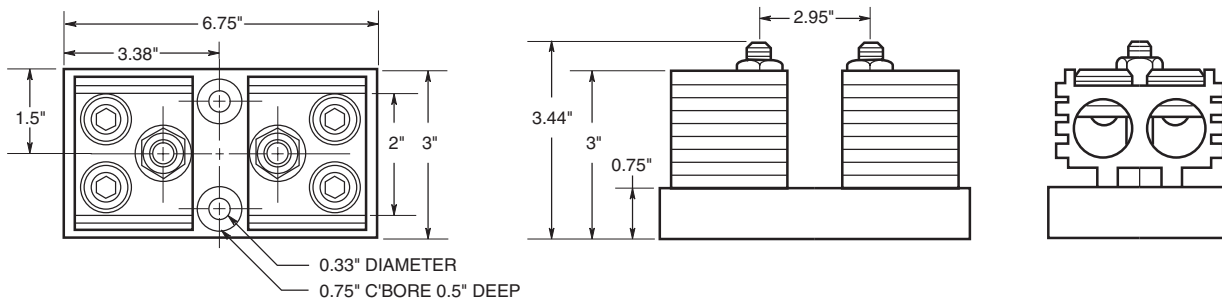

Figure 6. 401A to 600A



Class H(K), J and R Fuseblocks



Porcelain Type Fuseblocks

Class H(K) and R Dimensions

Agency Information: UL Listed, Guide IZLT, File E14853

Class H and K Dimension Fuseblocks - Porcelain Type

Volts	Amps	Poles	Fuseblocks	
			Terminal Type	
			Screw	Box Lug
250	1/10 to	1	2601	—
		2	2604	—
	30	3	2607	—
	31 to	1	—	2602
		2	—	2605
	60	3	—	2608
600	1/10 to	1	2610	—
		30	—	2611
	31 to	1	—	2611
		60	—	2611

CE logo denotes compliance with European Union Low Voltage Directive (50-1000Vac, 75-1500Vdc). Refer to Data Sheet: 8002 or contact Bussmann Application Engineering at 636-527-1270 for more information.



Modular Type Fuseblocks

Class H & J Fuses

Reinforced retaining clips standard

Available in 30A and 60A, 3-pole models only.

Agency Information: UL Recognized, Guide IZLT2,

File E14853

CSA Certified, Class 6225-01, File 47235

Modular Type For Class H & J Fuses

Fuse Type	Volts	Amps	Catalog Number		Figure Number
			Screw	Pressure	
H	250	60	11241-3SR	11241-3PR	1
			11242-3SR	11242-3PR	2
		30	11241-3SR	11241-3PR	1
	600	30	11242-3SR	11242-3PR	2
			60	11239-3SR	11239-3PR
		30	11240-3SR	11240-3PR	2
J	600	30	11241-3SR	11241-3PR	1
		60	11239-3SR	11239-3PR	1

Note: Order two blocks per fuse (matched or mixed.)



Figure 1



Figure 2

Notes:

- 11239 and 11241 have wire terminals and mounting holes located under fuse. (Figure 1)
- 11240 and 11242 have wire terminals and mounting holes located at end of fuse. (Figure 2)

CE logo denotes compliance with European Union Low Voltage Directive (50-1000Vac, 75-1500Vdc). Refer to Data Sheet: 8002 or contact Bussmann Application Engineering at 636-527-1270 for more information.



Class CC, Type M and Class G Fuseblocks



BC Series Class CC Fuseblocks

For use with Class CC Fuses (Bussmann LP-CC, KTK-R, and FNQ-R)

Construction:

Base - Thermoplastic
Clips - Bright tin-plated bronze

Ratings: 600V, 30A

Withstand Rating:
200,000A RMS Sym.

Agency Information:

UL Listed (Guide IZLT, File E14853)
CSA (Class 6225-01, File 47235)
UL Flammability: 94VO

Dimensional Data:

See Data Sheet.

DIN-RAIL Adaptors: Page 200
DRA-1 & DRA-2

Catalog Data

Amps	Poles	Terminal Type				
		Screw with Quick Connect*	Pressure Plate w/Quick Connect*	Pressure Plate w/Quick Connect*	Box Lug	Box Lug
1/2 to 30	1	BC6031S	BC6031SQ	BC6031P	BC6031PQ	BC6031B
	2	BC6032S	BC6032SQ	BC6032P	BC6032PQ	BC6032B
30	3	BC6033S	BC6033SQ	BC6033P	BC6033PQ	BC6033B

CE logo denotes compliance with European Union Low Voltage Directive (50-1000Vac, 75-1500Vdc). Refer to Data Sheet: 8002 or contact Bussmann Application Engineering at 636-527-1270 for more information.

Data Sheet: 1105

BCCM Series

For use with (2) Class CC Fuses and (1) 1 3/32" x 1 1/2" Fuse.

Catalog Data

Terminal Type	
Screw with Quick Connect*	Pressure Plate w/Quick Connect*
BCCM6033SQ	BCCM6033PQ

*Quick connect terminal rated for 20A max.

Data Sheet: 1106

BM Series Type M Supplementary Fuseblocks

For use with any 1 3/32" x 1 1/2" Fuses (Bussmann KTK, FNQ, FNM, BAF, BAN, and AGU)

Construction:

Thermoplastic

Ratings: 600V, 30A

Withstand Rating:
10,000A RMS Sym.

Agency Information:

UL Recognized (Guide IZLT2, File E14853)
CSA (Class 6225-01, File 47235)
UL Flammability: 94VO

Dimensional Data:

See Data Sheet.

DIN-RAIL Adaptors: Page 200
DRA-1 & DRA-2

Catalog Data

Amps	Poles	Terminal Type		
		Screw with Quick Connect*	Pressure Plate w/Quick Connect*	Box Lug
1/2 to 30	1	BM6031SQ	BM6031PQ	BM6031B
	2	BM6032SQ	BM6032PQ	BM6032B
30	3	BM6033SQ	BM6033PQ	BM6033B

CE logo denotes compliance with European Union Low Voltage Directive (50-1000Vac, 75-1500Vdc). Refer to Data Sheet: 8002 or contact Bussmann Application Engineering at 636-527-1270 for more information.

Data Sheet: 1104

CE logo denotes compliance with European Union Low Voltage Directive (50-1000Vac, 75-1500Vdc). Refer to Data Sheet: 8002 or contact Bussmann Application Engineering at 636-527-1270 for more information.

BG Series and G Series Class G Fuseblocks

For use with Class G Fuses (Bussmann SC)

Construction: (0-30) Thermoplastic
(35-60) Phenolic

Ratings: 600V, 0-20A

480V, 25-60A

Withstand Rating:
100,000A RMS Sym.

Agency Information:

UL Listed 35-60A (Guide IZLT, File E14853)
UL Recognized 1-30A, (Guide IZLT2, File E14853)
CSA (Class 6225-01, File 47235)

Dimensional Data:

See Data Sheet.

DIN-RAIL Adaptors: Page 200
DRA-1 & DRA-2

Catalog Data

Amps	Poles	Terminal Type			
		Screw with Quick Connect*	Pressure Plate w/Quick Connect*	Box Lug	Box Lug w/retaining clip
1 to 15	1	BG3011SQ	BG3011PQ	BG3011B	—
	2	BG3012SQ	BG3012PQ	BG3012B	—
20 to 35	3	BG3013SQ	BG3013PQ	BG3013B	—
	1	BG3021SQ	BG3021PQ	BG3021B	—
25 to 30	2	BG3022SQ	BG3022PQ	BG3022B	—
	3	BG3023SQ	BG3023PQ	BG3023B	—
35 to 60	1	BG3031S	BG3031P	BG3031B	—
	2	BG3032S	BG3032P	BG3032B	—
30	3	BG3033S	BG3033P	BG3033B	—
35 to 60	1	—	—	—	G30060-1CR
	2	—	—	—	G30060-2CR
60	3	—	—	—	G30060-3C G30060-3CR

CE logo denotes compliance with European Union Low Voltage Directive (50-1000Vac, 75-1500Vdc). Refer to Data Sheet: 8002 or contact Bussmann Application Engineering at 636-527-1270 for more information.

Data Sheet: 1106



Modular Fuseholders



CH Series

Features:

- 10 x 38 Dovetail design provides maximum flexibility in assembling multiple poles
- Touchsafe design - No exposed contacts
- DIN rail mount (35mm)
- Optional open fuse indication lights
- Excellent for switchboard panel, control consoles, small motors, transformers, and similar applications
- Handle/fusepuller to install and remove fuses easily
- Available in single and multi-pole configurations
- Circuit marking system (P/N CH10CL and CH10CM)
- Wire ready: Saves time as terminals are ready to accept wires.
- CE marking

Specifications

Fuse Size (mm)		10 x 38	14 x 51	22 x 58
Voltage	UL/CSA IEC	600V 690V	750V*** 660V	750V*** 660V
Amperage	UL/CSA IEC	30A 32A (See Watts Loss)	30A*** 50A (See Watts Loss)	50A*** 125A (See Watts Loss)
Wire Size		#8 - #18 CU only	#6 - #14 CU only	#1 - #14 CU only
Wire Type (& Temp.)		Solid/Stranded (75°)	Solid/Stranded (75°)	Solid/Stranded (75°)
Torque (in-lbs)		12 in-lbs	17.7 in-lbs	22.1 in-lbs
IP Rating		IP 20	IP 20	IP 20
Contact Material (fuseclip)		Tin-plated copper	Tin-plated copper	Tin-plated copper
Connector Material		Steel	Steel	Steel
Maximum Watts Loss of Fuse		3W‡	5W‡	9.5W‡
Dual Wire Rating		Please consult factory		

10 x 38	30A, 600V	30A, 600V	32A, 690V
Description	North American Class CC Fuseholder	North American Midget Fuseholder	European 10 x 38 Fuseholder
1 Pole	CHCC1	CHM1	CH101
1 Pole w/Indication	CHCC1I	CHM1I	CH101I
2 Pole	CHCC2	CHM2	CH102
2 Pole w/Indication	CHCC2I	CHM2I	CH102I
3 Pole	CHCC3	CHM3	CH103
3 Pole w/Indication	CHCC3I	CHM3I	CH103I
*Assembly Pins - 2 Poles	CH102AP	CH102AP	CH102AP
*Assembly Pins - 3 Poles	CH103AP	CH103AP	CH103AP
**Circuit markers	CH10CM	CH10CM	CH10CM
**Circuit marker labels	CH10CL	CH10CL	CH10CL
Spare Fuseholder	5TPH	5TPH	5TPH

‡Refer to Data Sheets 720003, 720008, 720025 and 720028 for watts loss of applicable fuses.

*CH102AP and CH103AP are packaged in quantities of ten pins. One pin is required to gang units together, and rating multiple poles.

**CH10CM are packaged in quantities of ten. CH10CL are packaged in quantities of ten sheets of labels.

***UL/CSA part numbers include U.L. suffix. (i.e. -14x51 with UL rating is CH141GUL for a single pole device)

Standards:

North American Class CC

Listed UL 512, Guide IZLT, File E14853

Certified CSA Std. C22.2 No. 39, Class 6225-01, File LR47235

North American Midget 1³/₃₂" x 1 1/2"

UL Recognized 512, Guide IZLT2, File E14853

CSA Certified, Std. C22.2 No. 39, Class 6225-01, File LR47235

European 10 x 38 IEC 269-2-1

14 x 51 IEC 269-2

UL Recognized, CSA Certified***

22 x 58 IEC 269-2

UL Recognized, CSA Certified***

Recommended Buss® Fuse Types:

North American Class CC Fuses - LP-CC, FNQ-R, KTK-R

North American Midget Fuses - FNQ, KTK, AGU, KLM, BAF, BAN, FNM, FWA, FWC, & FNQ

10 x 38 European Fuses - C10M, C10G

14 x 51 Fuses - FWX, FWH, FWP, NON, C14M, C14G

22 x 58 Fuses - FWP, C22M, C22G

	14 x 51		22 x 58	
Description	Part No.	Ctn. Qty.	Part No.	Ctn. Qty.
1 Pole	CH141G	6	CH221G	6
1 Pole w/UL markings	CH141GUL	6	CH221GUL	6
1 Pole w/microswitch	CH141MSG	6	CH221MSG	6
2 Pole	CH142G	3	CH222G	3
3 Pole	CH143G	2	CH223G	2
3 Pole w/microswitch	CH143MSG	2	CH223MSG	2
Handle Profile - 2 Poles	CH142HCG	10	CH222HCG	10
Handle Profile - 3 Poles	CH143HCG	10	CH223HCG	10

CE CE logo denotes compliance with European Union Low Voltage Directive (50-1000Vac, 75-1500Vdc). Refer to Data Sheet: 8002 or contact Bussmann Application Engineering at 636-527-1270 for more information.



For 1³/₃₂" × 1¹/₂" Fuses



3743

Add-on Fuseblocks for 1³/₃₂" × 1¹/₂" (10.3mm × 38.1mm) Fuses

UL Recognized Guide IZLT2, File E14853

Block with One Pole. Single pole blocks lock into each other and can be added at any time. Each has a single end barrier. Molded phenolic base; screw terminal; beryllium copper, bright-dipped clips. Rated 30A, 600V.

No. 3742—End Barrier Only.

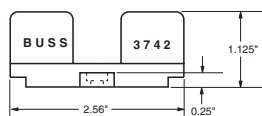
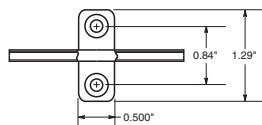

No. 3723—Marking Strip. Length is 9³/₈" (23.8cm). Block and end barrier.

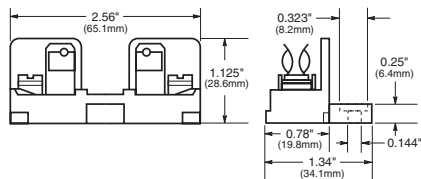

Note—Mounting screw hole diameter is 0.147" (3.7mm). Counterbore diameter, 0.636" (8.0mm) Max. Mounting Screw No. 6.

CE logo denotes compliance with European Union Low Voltage Directive (50-1000Vac, 75-1500Vdc). Refer to Data Sheet: 8002 or contact Bussmann Application Engineering at 636-527-1270 for more information.



3835

Series Multiple Pole Fuseblocks for 1³/₃₂" × 1¹/₂" (10.3mm × 38.1mm) Fuses

Silver-plated, beryllium copper clips. Rated 30A, 250V. No side barriers. Screw terminals. Phenolic base.

Cat. No.	No of Poles	Base Length	
		Inches	mm
3835-1	1	2 ⁷ / ₃₂ "	21.4
3835-2	2	1 ¹³ / ₁₆ "	46.0
3835-3	3	2 ²⁵ / ₃₂ "	70.6
3835-4	4	3 ³ / ₄ "	95.2
3835-5	5	4 ²³ / ₃₂ "	119.9
3835-6	6	5 ¹ / ₁₆ "	144.5
3835-7	7	6 ² / ₃₂ "	169.0
3835-8	8	7 ⁷ / ₈ "	193.7
3835-9	9	8 ¹⁹ / ₃₂ "	218.8
3835-10	10	9 ⁹ / ₁₆ "	242.9
3835-12	12	11 ¹ / ₂ "	292.1

*Base width—2³/₄" (69.9mm)

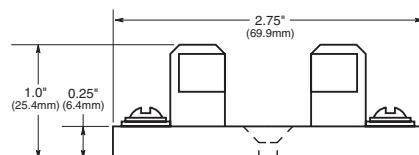

Note—Mounting screw hole diameter is 0.148" (3.7mm). Countersink, 0.313" (7.9mm). Max. Mounting Screw No. 6.

CE logo denotes compliance with European Union Low Voltage Directive (50-1000Vac, 75-1500Vdc). Refer to Data Sheet: 8002 or contact Bussmann Application Engineering at 636-527-1270 for more information.



4421 and 4515

Single Pole Fuseblocks for 1³/₃₂" × 1¹/₂" (10.3mm × 38.1mm) Fuses

Electrical Ratings: 30A, 250Vac (or less)

No. 4421—Solder Terminals. Base width 5⁸/₁₆" (15.9mm).

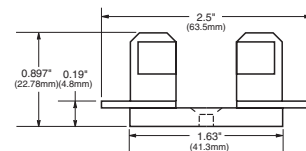

No. 4515—Screw Terminals. Base width 3⁴/₁₆" (19mm).

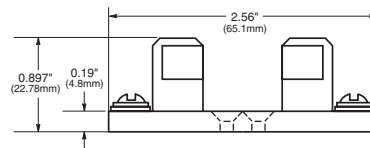

Note—Mounting screw hole diameter is 0.147" (3.7mm). Countersink, 0.312" (7.9mm). Max. Mounting Screw No. 6.

CE logo denotes compliance with European Union Low Voltage Directive (50-1000Vac, 75-1500Vdc). Refer to Data Sheet: 8002 or contact Bussmann Application Engineering at 636-527-1270 for more information.



Modular Fuseblocks



BH Series

For use with Bussmann semiconductor fuses.

Base: Light weight, high temperature thermoplastic

Mounting Studs: Plated steel

Nut: Plated steel

Washer: Spring steel

Agency Information:

UL Recognized, Guide EZLT2, File No. E14853 up to 700V

CSA Certified, Class 6225-01, File No. 47235 up to 700V

Withstand Rating: 200,000A RMS Sym., or interrupting rating of the fuse used, whichever is smaller.

Available Part Numbers

BH-0001	BH-1001	BH-2001	BH-3004
BH-0002	BH-1002	BH-2002	BH-3033
BH-0003	BH-1003	BH-2003	BH-3144
BH-0111	BH-1131	BH-2031	BH-3145
BH-0112	BH-1132	BH-2032	
BH-0113	BH-1133	BH-2033	
BH-0121		BH-3003	
BH-0122			

CE CE logo denotes compliance with European Union Low Voltage Directive (50-1000Vac, 75-1500Vdc). Refer to Data Sheet: 8002 or contact Bussmann Application Engineering at 636-527-1270 for more information.

Catalog Code Description:
Block Series

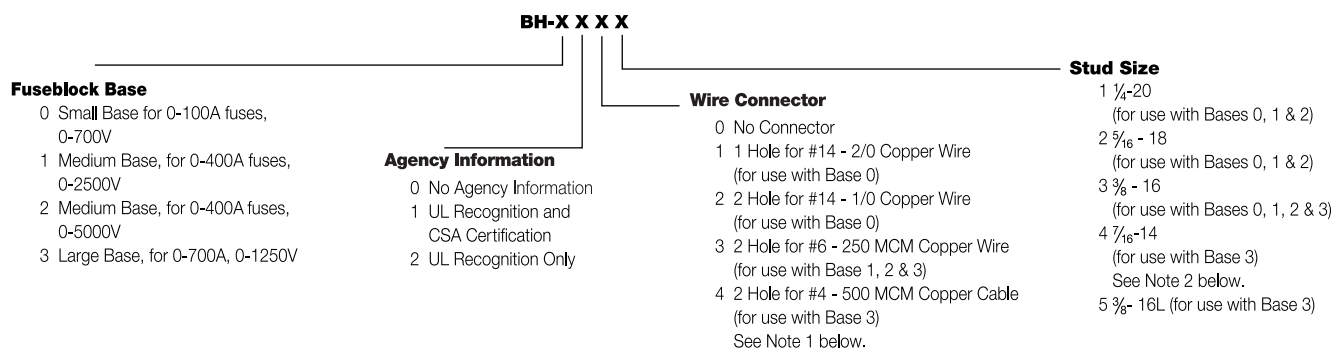

- General Notes:**
1. The #4 connector must be used with either the 7/16" - 14 or the 5/8" - 16L stud.
 2. The only compatible connector for the 7/16" - 14 stud is #4.
 3. Always check applicable end use standards for required spacing between blocks, fuses or other hardware.
 4. For applications above 700V, consult appropriate electrical standard for proper creepage distances, clearance distances and insulator voltage withstand ratings.



Box Cover Units for Plug Fuses



BOX COVER UNITS

SOU, SRU, SSU, SOW, SRW, SSW, SOX, SRX, SSX, SOY, SRY, SSY, SSY-RL, SSY-L, STY, SCY, SOY-B & SKA

- Plug-fuse Box Cover Units provide a simple inexpensive way to protect small motors with Buss dual-element FUSETRON Type T or FUSTAT Type S plug fuses.
- Box Cover Units are easily installed in standard electric boxes.
- Using fuses sized at the ampere rating of a motor or slightly larger, will provide optimum overload and short-circuit protection.

CE logo denotes compliance with European Union Low Voltage Directive (50-1000Vac, 75-1500Vdc). Refer to Data Sheet: 8002 or contact Bussmann Application Engineering at 636-527-1270 for more information.

Selection Data - Plug Fuse Box Cover Units

Box Cover Cat. No.	Type Box	Fuseholder		Receptacle Outlet to Load		Switch Control ¹	Switch Light ²	Motor Size (Max.)	General Data	Agency ⁴ Listing/Certification
		Single	Double	125V	250V					
SOU	2 1/4" Handy	X						3/4 HP	125V, 15A	UL, CSA
SRU		X		X				1/2 HP	125V, 15A	UL
SSU ⁵		X				X		1/2 HP	125Vac, (do not use on dc), 15A	UL, CSA
SOW	2 3/4" Switch	X						3/4 HP	125V, 15A	UL, CSA
SRW		X		X				1/2 HP	125V, 15A	UL
SSW		X				X		1/2HP	125Vac, (do not use on dc), 15A	UL, CSA
SOX	4" Octagon	X						3/4 HP	125V, 15A	UL, CSA
SRX		X		X				1/2 HP	125V, 15A	UL
SSX		X				X		1/2 HP	125Vac, (do not use on dc), 15A	UL, CSA
SOY		X						3/4 HP	125V, 15A	UL, CSA
SRY	4" Square	X		X				1/2 HP	125V, 15A	UL
SSY		X				X		1/2 HP	125Vac, (do not use on dc), 15A	UL, CSA
SSY-RL		X		X		X	X	1/2 HP	125Vac, (do not use on dc), 15A	—
STY ³			X			X		1/2 HP	125Vac, (do not use on dc), 15A	UL
SCY				X		X(2)		1/2 HP (2)	125Vac, (do not use on dc), can protect two motors, 15A	UL
SOY-B				X				3/4 HP	125V, protects two motors, 15A	UL
SKA	4 1/16" Square		X		X(15A)			2 HP	250V, 15A single phase	UL

¹Switch turns power to fused load OFF or ON.

²Switch light indicates power to load (dark when switch OFF or fuse open).

³Double-pole switch opens both side of circuit. STY can be used for two separate 125V motors not larger than 1/2 HP with the common switch, or a single motor not larger than 2 HP at 250V (Maximum of 150V to ground).

⁴UL Guide JAMZ, File IE6491; CSA Class 6225-01, File 47235.

⁵Weatherproof version available, Part No. SSN.



Printed Circuit Board Mount for 5mm × 20mm Fuses



HTC-45M

PCB Vertical Mount

250V, 6.3A, 2.5W
 Bayonet Cap/Carrier
 See specifications below

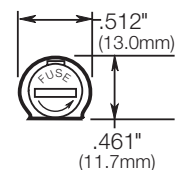
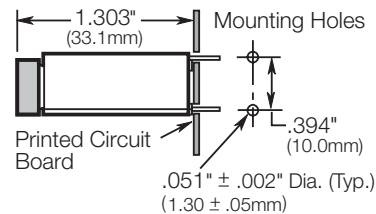

CE CE logo denotes compliance with European Union Low Voltage Directive (50-1000Vac, 75-1500Vdc). Refer to Data Sheet: 8002 or contact Bussmann Application Engineering at 636-527-1270 for more information.

Data Sheet: 2110



HTC-50M

PCB Horizontal Mount

250V, 6.3A, 2.5W
 Bayonet Cap/Carrier
 See specifications below

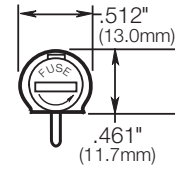
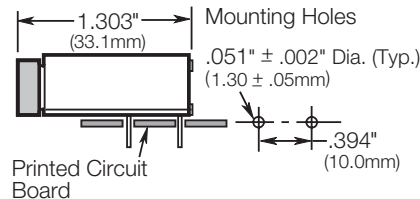

CE CE logo denotes compliance with European Union Low Voltage Directive (50-1000Vac, 75-1500Vdc). Refer to Data Sheet: 8002 or contact Bussmann Application Engineering at 636-527-1270 for more information.

Data Sheet: 2110



HTC-60M, HTC-65M

250V, 6.3A
 Body Material: Valox DR48
 Terminals: Phosphor bronze

HTC-60M (2 Legs)

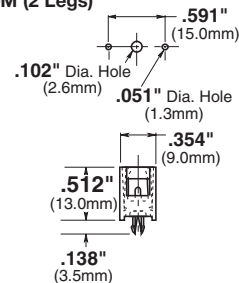

HTC-65M (4 Legs)

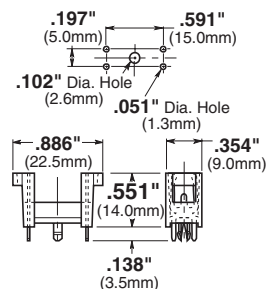

CE CE logo denotes compliance with European Union Low Voltage Directive (50-1000Vac, 75-1500Vdc). Refer to Data Sheet: 8002 or contact Bussmann Application Engineering at 636-527-1270 for more information.

Data Sheet: 2110

Specifications

- Terminals:** For HTC-45M, HTC-50M Tin-plated.
- Molded Materials:** High temperature thermoplastic that meets the flammability ratings of UL 94V0; Glow Wire Test: 960°C per IEC 695-2-1.
- Solderability:** In accordance with IEC 68-2-20.
- Electrical:** Contact Resistance: ≤ 10mΩ; Insulation Resistance: ≥ 10mΩ; Dielectric Strength ≥ 2000 Vac.
- Shock Safety:** PC2 (fuseholders).
- Agency Information:** HTC-45M, HTC-50M UL Recognized, (Guide IZLT2, File E14853; 6.3A, 250V; CSA Certified, (Class 6225-01, File 47235; 6.3A, 250V) SEMKO: (9226032; 6.3A, 250V).
- Packaging:** Standard Qty 10 (No Prefix), Bulk Qty 100 (Prefix Catalog Number with BK/).



PC Board Mount for 5mm x 20mm and 1/4" x 1 1/4" Fuses

HBH-I (for 1/4" x 1 1/4" fuses)
HBH-M (for 5mm x 20mm fuses)
Horizontal Mount

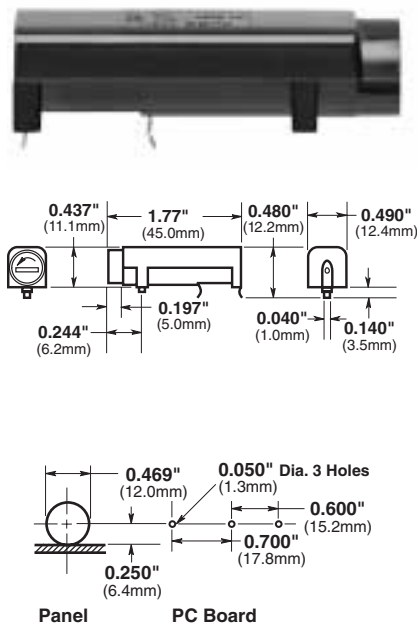

Data Sheet: 2118

HBV-I (for 1/4" x 1 1/4" fuses)
HBV-M (for 5mm x 20mm fuses)
Vertical Mount with Stability Pins

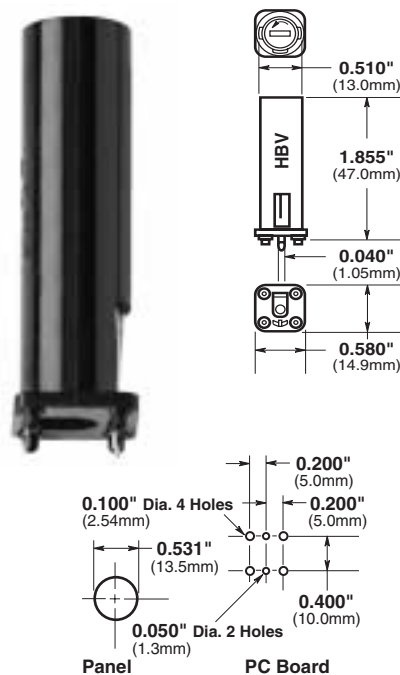

Data Sheet: 2118

HBW-I (for 1/4" x 1 1/4" fuses)
HBW-M (for 5mm x 20mm fuses)
Vertical Mount without Stability Pins

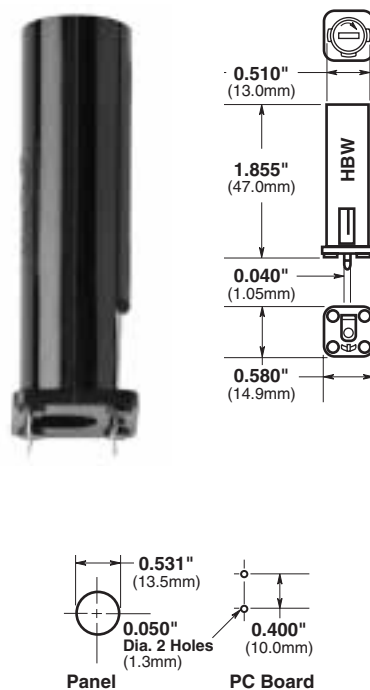

Data Sheet: 2118

Fuseholder Caps (Fit all three shown above)



Specifications

Electrical Ratings: UL — 16A @ 250V; CSA — 12A @ 250V; VDE — 6.3A @ 250V; SEMKO — 10A @ 250V
 Insulation resistance — 10,000 megohm at 500Vdc. Contact resistance — less than 0.005 ohms @ 20mV. Dielectric strength — over 200V/mil.

Molded Material: High dielectric molded phenolic with a UL 94VO flammability rating.

Fuse Carrier & Knob: Spring-loaded, bayonet type. Tin plated brass. Screwdriver slotted.

Mounting: "Kicked" terminals (all models) and stabilizer pins on HBV model for increased stability.

Environmental: Maximum operating temperature — (-40°C to +85°C).

Agency Information: UL Recognized — Guide IZLT2, File EI4853;
 CSA Certified — Class 6225-01, File 47235
 VDE — 41421
 SEMKO — 9308147 (HBH, HBV) 9222106 (HBW)

CE logo denotes compliance with European Union Low Voltage Directive (50-1000Vac, 75-1500Vdc). Refer to Data Sheet: 8002 or contact Bussmann Application Engineering at 636-527-1270 for more information.



Panel Mounted for 5mm x 20mm Fuses

HTC-30M

Ratings: 250V, 6.3A, 2.5W
Screwdriver slot

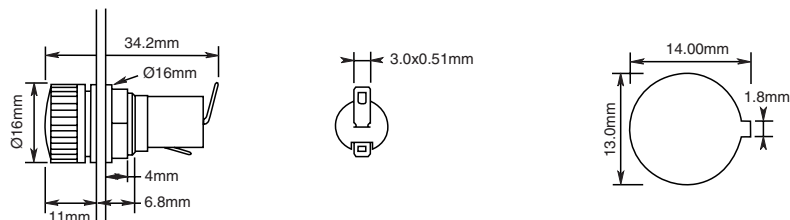

Data Sheet: 2110

HTC-35M

Ratings: 250V, 6.3A, 2.5W
Threaded cap

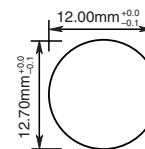
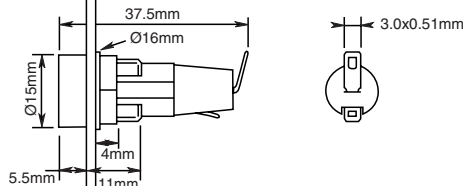

Data Sheet: 2110

HTC-40M

Ratings: 250V, 6.3A, 2.5W
Screwdriver slot

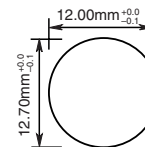
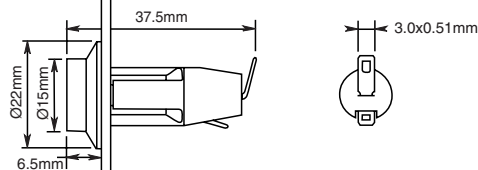

Data Sheet: 2110

HTC-55M

Ratings: 250V, 6.3A, 2.5W
Fuse carrier: bayonet type

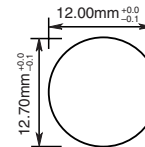
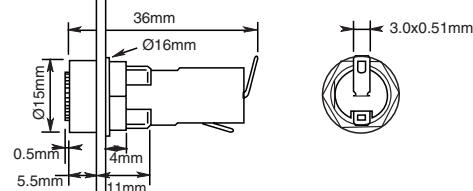

Data Sheet: 2110

HTC-70M

Ratings: 250V, 10A, 2.5W
Fuse carrier: bayonet type

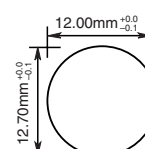
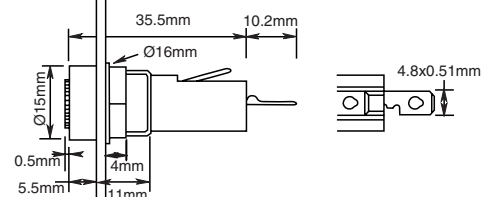

Data Sheet: 2110

Specifications

- Terminals:** Brass, tin-plated.
- Molded Materials:** High temperature thermoplastic that meets the flammability ratings of UL 94VO; Glow Wire Test: 960°C per IEC 695-2-1.
- Solderability:** In accordance with IEC 68-2-20.
- Agency Information:** UL Recognized — Guide IZLT2, File E14853; CSA Certified — Class 6225-01, File 47235; SEMKO — 9226031 (HTC-30M, HTC-35M); 9226032 (HTC-40M); 9226033 (HTC-55M); 9226034 (HTC-70M)
- Electrical:** Contact Resistance: ≤ 10mΩ; Insulation Resistance: ≥ 10mΩ; Dielectric Strength ≥ 2000 Vac.
- Shock Safety:** PC2 (fuseholders).
- Packaging:** Standard Qty 10 (No Prefix), Bulk Qty 100 (Prefix Catalog Number with BK/).

CE logo denotes compliance with European Union Low Voltage Directive (50-1000Vac, 75-1500Vdc). Refer to Data Sheet: 8002 or contact Bussmann Application Engineering at 636-527-1270 for more information.



Panel Mounted for 1/4" x 1 1/4" Fuses



HKP, HKP-L, HKP-W Standard Fuseholders

Electrical Ratings for HPF Series

Catalog Symbol	Amps	Volts	Fuse Description
HKP	30	250	—
HKP-L	30	250	HKP with 2250V stand-off barrier.
HKP-W	30	250	HKP with drip-proof knob.

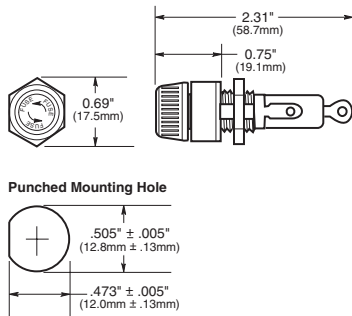

Data Sheet: 2106



HKP-BBHH, HKP-HH and HKP-LW-HH Fuseholders with 1/4" Quick-connects

Electrical Ratings for HPF Series

Catalog Symbol	Amps	Volts	Fuse Description
HKP-BBHH	15	250	HKP with 1/4" quick connects, nut and washer assembled.
HKP-HH	15	250	HKP with 1/4" quick-connect.
HKP-LW-HH	15	250	HKP with drip-proof knob, 2250V stand-off barrier and quick-connects.

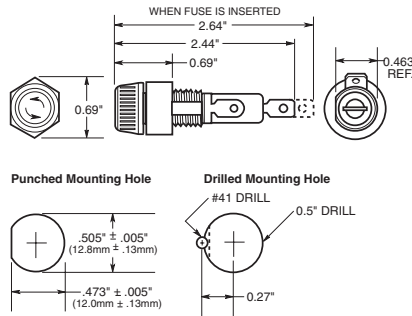

Data Sheet: 2106



HKP-OO Snap-Lock Fuseholders

Electrical Ratings for HPF Series

Catalog Symbol	Amps	Volts	Fuse Description
HKP-OO	30	250	HKP with snap-lock.

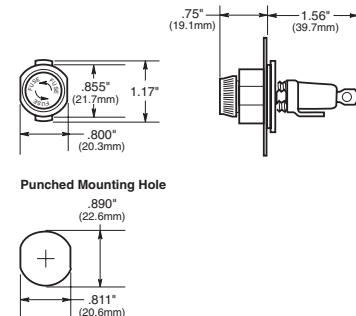

Data Sheet: 2106

Specifications

- Terminals:** Bayonet-type knob.
Vibration resistant.
For panels up to 5/16" (7.9mm) thick.

Agency Information: UL Recognized — Guide IZLT2, File E14853
CSA Certified — Class 6225-01, File 47235

Replacement Parts: Knob: 9435-1/2"
Plastic Nut: BK/1A4287
Metal Nut: BK/1A4806-2
Washer: 9732

CE logo denotes compliance with European Union Low Voltage Directive (50-1000Vac, 75-1500Vdc). Refer to Data Sheet: 8002 or contact Bussmann Application Engineering at 636-527-1270 for more information.



Panel Mounted for 5mm x 20mm and 1/4" x 1 1/4" Fuses



HTB Series

Fuseholders with Knob-Type Carriers

Agency Information:

UL Recognized — Guide IZLT2, File E14853
 20A (3/16" quick-connect 15A) @ 250V
 CSA — 16A @ 250V Class 6225-01 File 47235;
 VDE* — 6.3A @ 250V, 49890
 SEMKO* — 6.3A @ 250V, 8945092, 9005230
 *Screwdriver slot carrier only

Electrical Data: Insulation resistance (per IEC #257) — 10,000 ohms @ 500Vdc; contact resistance (per IEC #257) — 0.005 ohms max. @ 1A; standoff voltage (per IEC #257) — 480V/Mil @ .125 in. thickness.

Environmental: Maximum operating temperature -55°C to 85°C.

Molded Components: High temperature, flame retardant, thermoplastic; UL Component Recognized; 94VO; mounting nut, spacer-black polycarbonate.

Terminals: Tin-plated brass.

Mounting: Withstands 15 to 20 lbs-ins torque to mounting nut when mounting fuseholder to panel. Maximum panel thickness 0.300 inches.

CE logo denotes compliance with European Union Low Voltage Directive (50-1000Vac, 75-1500Vdc). Refer to Data Sheet: 8002 or contact Bussmann Application Engineering at 636-527-1270 for more information.

Dimensional Data

Knob Type Carrier	Maximum Panel Thickness	Terminal Options				Carrier Options	
		Solder/ 3/16" Quick-Connect		1/4" Quick-Connect		1/4" x 1 1/4" ("I" Equals Inches)	5mm x 20mm ("M" Equals Metric)
		In-Line	Rt. Angle	In-Line	Rt. Angle	Knob	Knob
Common Dimensional Data: Length (Knob Type) - 1.69" (42.9mm) Plus In-Line Terminal (Screwdriver Slotted) 1.75" (44.5mm) NOTE: Plus In-Line Terminal							
 Low Profile Rear Hex Nut	0.30" 7.62mm	HTB-22I	HTB-24I	HTB-26I	HTB-28I	✓	—
 HTB-2		HTB-22M	HTB-24M	HTB-26M	HTB-28M	—	✓
 High Profile Rear Hex Nut	0.125" 3.18mm	HTB-42I	HTB-44I	HTB-46I	HTB-48I	✓	—
 HTB-4		HTB-42M	HTB-44M	HTB-46M	HTB-48M	—	✓
 Front Hex Nut	0.30" 7.62mm	HTB-62I	HTB-64I	HTB-66I	HTB-68I	✓	—
 HTB-6		HTB-62M	HTB-64M	HTB-66M	HTB-68M	—	✓
 Low Profile Snap-In	0.125" 3.18mm	HTB-82I	HTB-84I	HTB-86I	HTB-88I	✓	—
 HTB-8		HTB-82M	HTB-84M	HTB-86M	HTB-88M	—	✓

Fuseholders and fuse carriers may be ordered separately.



Panel Mounted for 5mm x 20mm and 1/4" x 1 1/4" Fuses

HTB Series Fuseholders with Screwdriver Slotted Carriers



Dimensional Data

Knob Type Carrier	Maximum Panel Thickness	Terminal Options				Carrier Options	
		Solder/ 3/16" Quick-Connect		1/4" Quick-Connect		1/4" x 1 1/4" ("I" Equals Inches)	5mm x 20mm ("M" Equals Metric)
		In-Line	Rt. Angle	In-Line	Rt. Angle	Screwdriver	Screwdriver
Common Dimensional Data: Length (Knob Type) - 1.69" (42.9mm) Plus In-Line Terminal (Screwdriver Slotted) 1.75" (44.5mm) NOTE: Plus In-Line Terminal		HTB-32I	HTB-34I	HTB-36I	HTB-38I	✓	—
		HTB-32M	HTB-34M	HTB-36M	HTB-38M	—	✓
	0.125" 3.18mm	HTB-52I	HTB-54I	HTB-56I	HTB-58I	✓	—
		HTB-52M	HTB-54M	HTB-56M	HTB-58M	—	✓
	0.125" 3.18mm	HTB-92I	HTB-94I	HTB-96I	HTB-98I	✓	—
		HTB-92M	HTB-94M	HTB-96M	HTB-98M	—	✓

Fuseholders and fuse carriers may be ordered separately.

Ordering Information

	HTB-				S	P	FUSE CARRIER ONLY	
Packing (Blank) - Std. BK/ - Bulk	Product Symbol			Fuse Carrier I - 1/4" x 1-1/4" M - 5mm x 20mm	Splash Proof (Optional on -2, -4, -6, and -8)			
Body Configuration and Mounting Finger Grip Holders 2 - Low Profile (Rear Panel Hex-Nut) 4 - High Profile *6 - (Front Panel Hex-Nut) 8 - Low Profile (Snap-In) Screwdriver Slotted Holders 3 - Low Profile 5 - High Profile 9 - Low Profile (Snap-In)	Rear Terminal Configuration 2 - Solder/3/16" Quick-Connect (In-Line) 4 - Solder/3/16" Quick-Connect (Right Angle) 6 - 1/4" Quick-Connect (In-Line) 8 - 1/4" Quick-Connect (Right Angle)						Packaging (Blank) - Std. BK/ - Bulk	Product Symbol FT - Knob Type (For 20, 40, 60, and 80 Series Only) ST - Screwdriver Slotted (For 30, 50, and 90 Series Only)
							Fuse Carrier I - 1/4" x 1 1/4" M - 5mm x 20mm	

*Profile varies with panel thickness. Holder installs thru rear of panel.



Panel-Mounted for Indicating Type Fuses



HLD Pin Indicating for 1/4" x 1 1/4" Fuses

Voltage Rating: 250V, 15A

Agency Information:

UL Recognized, (File E14853, Guide IZLT2)

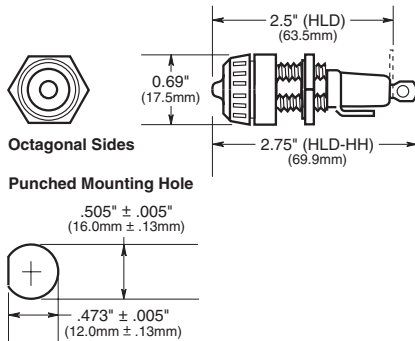

Electrical Ratings

Symbol	Amps	Volts	Features
HLD	15	250	Solder terminals
HLD-HH	15	250	1/4" quick-connect terminals

Use w/GBA, GLD Fuses

CE logo denotes compliance with European Union Low Voltage Directive (50-1000Vac, 75-1500Vdc). Refer to Data Sheet: 8002 or contact Bussmann Application Engineering at 636-527-1270 for more information.



HJL Lamp Indicating for 1/4" x 1" Fuses

Voltage Rating: 250V, 15A

No Agency Information

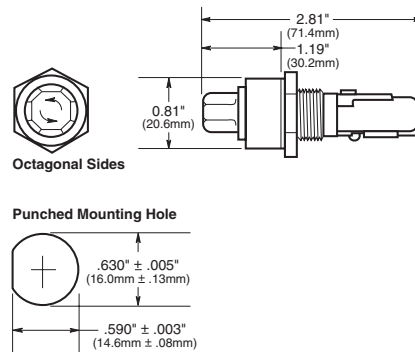

Electrical Ratings

Symbol	Amps	Lamp		Knob	
		Volts	Type	Color	Type
HJL	15	90 to 250	Neon	Clear	Oct

Use w/AGX, MKB Fuses
For panels up to 1/8" thick.



HK Series Lamp Indicating for 1/4" x 1 1/4" Fuses

Voltage Rating: 250V, 15A or 20A

Agency Information:

UL Recognized, (Guide IZLT2, File E14853)
CSA Certified (Class 6225-01, File 47235)

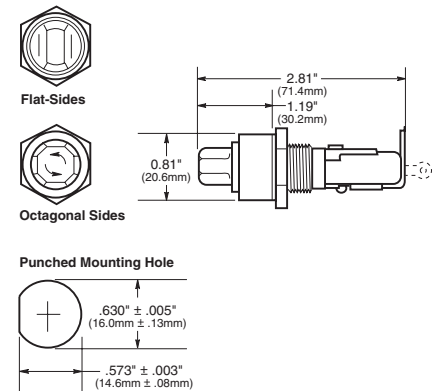

Electrical Ratings

Symbol	Amps	Lamp		Knob	
		Volts	Type	Color	Type
HKL*	15	90 to 250	Neon	Clear	Oct
HKL-X*					FS
HKR	20	22 to 30	**	Amber	Oct
HKT		13 to 22	**	Amber	Oct
HKU		4 to 6	**	Red	Oct
HKX		22 to 33	**	Amber	FS

* UL Recognized and CSA Certified
** Incandescent

CE logo denotes compliance with European Union Low Voltage Directive (50-1000Vac, 75-1500Vdc). Refer to Data Sheet: 8002 or contact Bussmann Application Engineering at 636-527-1270 for more information.



In-Line Fuseholders for 1/4" x 7/8" to 1 1/4" Fuses



HFB

Waterproof In-Line Fuseholder for 1/4" x 1 1/4" Fuses

Voltage Rating: 32V, 30A

Construction:

- Body - Thermoplastic rubber;
- Contacts - Copper tin plated

Catalog Numbers

Description	Catalog Number
Standard Pack (10-in)	HFB
Bulk Pack (20-in)	BK/HFB
Replacement Contact Clip	BK/1A2294

Dimensional Data

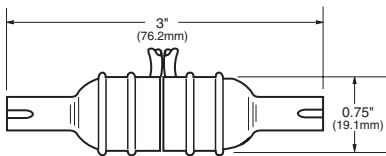

- Ideal for harsh environments:
 - -40° to 150° temp. range
 - Withstands many organic solvents and rigorous shock and vibration.
- Accepts #12 to #18 wire leads (not provided).
- Simple assembly.
- One-piece molded thermo-plastic.
- High visibility yellow color for easy identification in dark or hard-to-access locations.
- Important information molded into body.
- See Data Sheet for recommended crimp tools.

Data Sheet: 2102



HHB

Universal In-Line Fuseholder for 1/4" x 7/8", 1" and 1 1/4" Fuses

Voltage Rating: 32V, 30A

Construction:

- Body - Nylon;
- Contacts - Copper tin plated

Pull Force: 5 lbs. minimum to separate fuseholder housing with fuse installed.

UL Flammability Rating: 94 V2

Catalog Numbers

Description	Catalog Number
Holder (Without Leads)	
Standard Pack (10-in)	HHB
Bulk Pack (100-in)	BK/HHB

Holder With Pre-attached Lead Wires

(#14 Insulated)		
Wire Color	19" Length	8" Length
Yellow	BK/HHB-Y419	BK/HHB-Y408
Red	BK/HHB-R419	BK/HHB-R408
Black	BK/HHB-B419	BK/HHB-B408

Dimensional Data

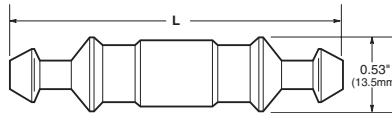

Fuse Length	Fuseholder Length "L"
7/8" (AGW)	2.100 Max.
1" (AGX)	2.250 Max.
1 1/4" (AGC, MDL)	2.420 Max.

- Accepts #12 to #16 wire leads (not provided with basic fuseholder).
- See Data Sheet for recommended crimp tools.

Data Sheet: 2103



HRK

Universal In-Line Fuseholder for 1/4" x 7/8" to 1 1/4" Fuses

Voltage Rating: 32V, 15A

Electrical Ratings

Catalog Symbol	Amps	Volts	Fuse Description
HRK	15	32	1/4" diameter fuses of different lengths.

Dimensional Data

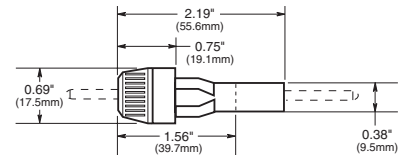

- Three springs furnished with fuseholder afford acceptance of 1/4" fuses of different lengths.
- Wire leads are staked and soldered to the contacts of the fuseholder.
- Leads are 8" (203mm) long.
- Wire size - #14.

Data Sheet: 2111



In-Line Fuseholders



HR and HM Series In-Line Fuseholders for SFE and 1/4" x Various Length Fuses

Voltage Rating: 32V, 20A
No agency listings.

Electrical Ratings

Catalog Symbol	Includes Fuse	Wire
HRJ*	SFE-20	19" of #14
HRI	SFE-14	
HRH	SFE-9	
HRE	SFE-7½	
HRG	SFE-6	
HRF	SFE-4	
HMJ**	SFE-20	8" of #14
HMI	SFE-14	
HMH	SFE-9	
HME	SFE-7½	
HMG	SFE-6	
HMF	SFE-4	

*Also available as in-line fuseholder only with lead wire contacts, HPJ-LES-Fuse.
**Also available as in-line fuseholder only with lead wire contacts, HMJ-LES-Fuse.

HHJ-A For 1/4" x 1 1/4" fuse, no wire or fuse included, accepts #18 - #22 wire.

HHJ-B For 1/4" x 1 1/4" fuse, no wire or fuse included, accepts #12 - #16 wire.

HHI-B For 1/4" x 1 1/4" fuse, no wire or fuse included, accepts #12 - #16 wire.

Dimensional Data

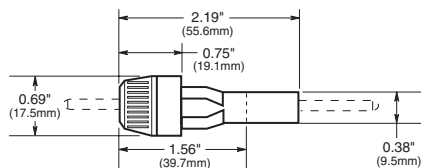

HFA Series In-Line Waterproof Fuseholders for 1/4" x 1 1/4" Fuses

Construction:
Body - Phenolic;
Contacts - Copper crimp leads

Voltage Rating: 250V, 20A

Agency Information:
UL Recognized, (Guide IZLT2, File E14853)
UL Flammability Rating: 94VO

Electrical Ratings

Catalog Symbol	Amps	Volts	Terminals
HFA	20	250	Crimp #12 - #16
HFA-HH*	20	250	1/4" Q.C.

*No UL Recognition.

Dimensional Data

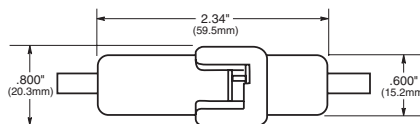

CE CE logo denotes compliance with European Union Low Voltage Directive (50-1000Vac, 75-1500Vdc). Refer to Data Sheet: 8002 or contact Bussmann Application Engineering at 636-527-1270 for more information.



HHT Series In-Line Fuseholders for 5 x 15mm or 5 x 20mm Fuses

Construction:
Body - Black Thermoplastic
Contacts - Brass
Wire - 16 awg, red

Electrical Ratings

	Amps	Volts
5 x 15mm	5	32
5 x 20mm	10	32

Dimensional Data

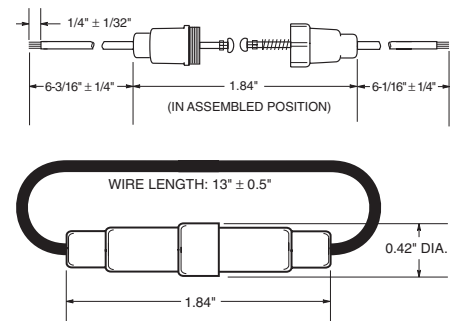

Data Sheet: 2122

Data Sheet: 2115

Data Sheet: 2138

Panel-Mounted for 1 3/32" x 1 5/16" to 1 1/2" Fuses



HPF Standard Fuseholders with Screw-type Knob for 1 3/32" x 1 5/16" to 1 1/2" Fuses

Agency Information:

UL Recognized, (Guide IZLT2, File E14853)

CSA Certified (Class 6225-01, File 47235)

Flammability Rating: UL 94HB

- Combination 1/4" quick-connect/solder terminals.

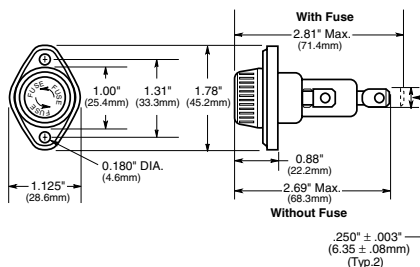

CE logo denotes compliance with European Union Low Voltage Directive (50-1000Vac, 75-1500Vdc). Refer to Data Sheet: 8002 or contact Bussmann Application Engineering at 636-527-1270 for more information.

Electrical Ratings

Catalog Symbol	Amps	Volts	Fuse Description
HPF	30 ⁽³⁾	600	1 1/2" (38.1mm)
HPF-C	30 ⁽⁴⁾	600 ⁽⁴⁾	1 1/2" (38.1mm) clear knob.
HPF-L	5	600	BBS, 1 3/32" x 1 3/16" fuses.
HPF-EE	15	600	SC 0-15, 1 3/32" x 1 5/16" fuses.
HPF-JJ	20	600	SC 20, 1 3/32" x 1 13/32" fuses.
HPF-FF ⁽²⁾	30 ⁽³⁾	480	SC 25 & 30, 1 3/32" x 1 5/16" fuses.
HPF-RR	30 ⁽³⁾	600	KTK-R, LP-CC & FNQ-R Class CC fuses.
HPF-WT	30 ⁽³⁾	600	Splash-proof knob.
HPF-F-EE ⁽²⁾	15	600	Sleeve on body, leaded for 1 3/32" x 1 5/16" fuses.

⁽²⁾No CSA Certification
⁽³⁾20A max when used with quick connect terminals.
⁽⁴⁾HPF-C ratings for CSA-15A, 250V

Data Sheet: 2114



HPS Standard Fuseholders with Bayonet-type Knob for 1 3/32" x 1 5/16" to 1 1/2" Fuses

Agency Information:

UL Recognized, (Guide IZLT2, File E14853)

CSA Certified (Class 6225-01, File 47235)

Flammability Rating: UL 94HB

- Combination 1/4" quick-connect/solder terminals.
- The -EE, -JJ, -FF and -RR are UL Recognized for applications requiring branch circuit protection.

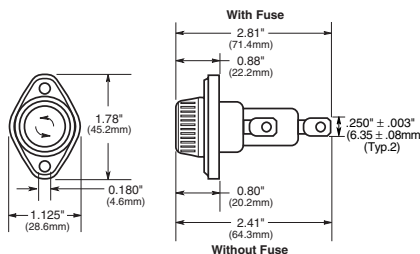

CE logo denotes compliance with European Union Low Voltage Directive (50-1000Vac, 75-1500Vdc). Refer to Data Sheet: 8002 or contact Bussmann Application Engineering at 636-527-1270 for more information.

Electrical Ratings

Catalog Symbol	Amps	Volts	Fuse Description
HPS	30 ⁽³⁾ /4/600		1 3/32" x 1 1/2"
HPS-L	5	600	BBS, 1 3/32" x 1 3/16" fuses.
HPS-EE	15	600	SC 0-15, 1 3/32" x 1 5/16" fuses.
HPS-JJ	20	600	SC 20, 1 3/32" x 1 13/32" fuses.
HPS-F-EE ⁽²⁾	15	600	Sleeve on body, leaded for 1 3/32" x 1 5/16" fuses.
HPS-FF ⁽²⁾	30 ⁽³⁾	480	SC 25 & 30, 1 3/32" x 1 5/16" fuses.
HPS-RR ⁽²⁾	30 ⁽³⁾	600	KTK-R, LP-CC, FNQ-R Class CC fuses.

⁽¹⁾No UL Recognition
⁽²⁾No CSA Certification
⁽³⁾20A max when used with quick connect terminals.
⁽⁴⁾HPS rated at 25V for CSA

Data Sheet: 2113



HPG and HPD Standard Fuseholders with Bayonet-type Knob for 1 3/32" x 1 1/2" Fuses

Agency Information:

UL Recognized, (Guide IZLT2, File E14853)

Flammability Rating: UL 94V0 - Fuseholder body
 UL 94HB - Knob

HPG HPG-EE

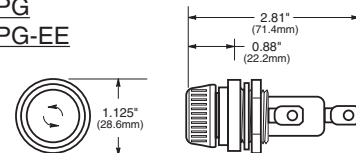

HPD

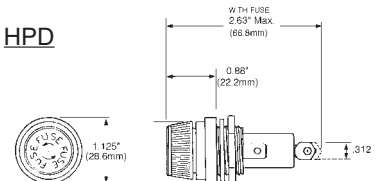

CE logo denotes compliance with European Union Low Voltage Directive (50-1000Vac, 75-1500Vdc). Refer to Data Sheet: 8002 or contact Bussmann Application Engineering at 636-527-1270 for more information.

Electrical Ratings

Catalog Symbol	Amps	Volts	Fuse Description
HPG	30 ⁽³⁾	600	1 3/32" x 1 1/2" fuses
HPG-EE	15	600	SC 0-15, 1 3/32" x 1 5/16" fuses.
HPD	30 ⁽³⁾	600	1 3/32" x 1 1/2" fuses

⁽³⁾20A max when used with quick connect terminals.

NOTE:

- HPG and HPG-EE has combination 1/4" quick-connect/solder terminals on both side (load) and rear (line) terminals.
- HPD has combination 1/4" quick-connect/solder terminal on side (load) terminal only. Rear (line) terminal is 3/16" shorter than HPG. Rear Terminal solder only.

Data Sheet: 2108



Panel-Mounted for 1 3/32" x 1 1/2" Fuses



HPM

Standard Fuseholder with Screw-type Knob for 1 3/32" x 1 1/2" Fuses

Agency Information:

UL Recognized, (Guide IZLT2, File E14853)
 CSA Certified (Class 6225-01, File 47235)
 Flammability Rating: UL 94HB

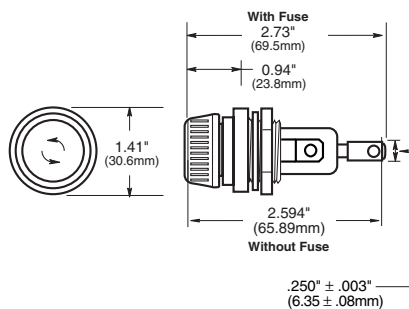

Electrical Ratings

Catalog Symbol	Amps	Volts	Description
HPM	30 ⁽³⁾	600	1/4" quick-connect/solder
HPM-D	30 ⁽³⁾	600	Splash-resistant knob ⁽⁴⁾

⁽³⁾20A max when used with quick-connect terminals.
⁽⁴⁾HPM-D has 1/4" quick-connect/solder terminal on rear (load) terminal only. The side (line) terminal is 1/4" quick-connect only.

CE logo denotes compliance with European Union Low Voltage Directive (50-1000Vac, 75-1500Vdc). Refer to Data Sheet: 8002 or contact Bussmann Application Engineering at 636-527-1270 for more information.



HPC-D

Fuseholder with Splash-resistant Knob for 1 3/32" x 1 1/2" Fuses

Agency Information:

UL Recognized, (Guide IZLT2, File E14853)
 • Supplied with O-ring and panel gasket.
 Flammability Rating: UL 94HB

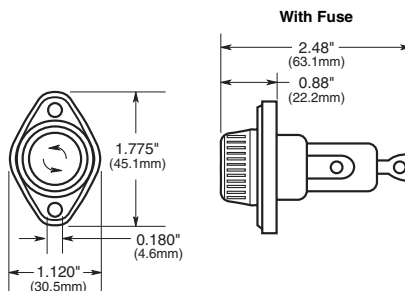

Electrical Ratings

Catalog Symbol	Amps	Volts	Description
HPC-D	30 ⁽³⁾	600	Mount in panels up to 1/4" thick.
HPC-DK ⁽¹⁾	15	600	1/4" quick-connect terminals.

⁽¹⁾No UL Recognition
⁽³⁾20A max when used with quick-connect terminals.

Replacement knob - BK/9987SA

CE logo denotes compliance with European Union Low Voltage Directive (50-1000Vac, 75-1500Vdc). Refer to Data Sheet: 8002 or contact Bussmann Application Engineering at 636-527-1270 for more information.



HPS2

Catalog Symbol: HPS2

Description: Meets requirement of UL 1598 that both poles be removed simultaneously.

Fuse Type: 13/32" x 1-1/2"

Agency Information:

UL 512 recognized, (Guide IZLT2, File E14853)
 CSA certified: (Class 6225-01, File 47235)
 Flammability Rating: UL 94V0

Terminals: 1/4" quick connect / solder

Electrical Rating: 30A @ 600V (20A max when used with quick-connect terminals.)

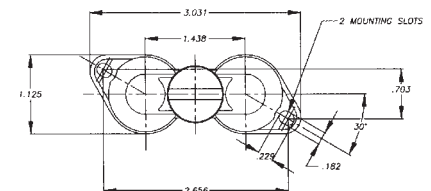

Catalog Symbol

HPS2	standard 10-in carton
BK/HPS2	bulk 100-in carton



Tron® In-Line Fuseholders

Single Pole

Type SC Fuses



HEG Series
In-Line Fuseholders
Single-Pole
Voltage Rating: 600V, 15A
Non-Breakaway Holders

For SC Fuses 0 to 15A,
 480V (or less).
 Fuse size $1\frac{3}{32}'' \times 1\frac{5}{16}''$.

Data Sheet: 2124



HEH Series
In-Line Fuseholders
Single-Pole
Non-Breakaway Holders
Voltage Rating: 600V
Current Rating: 20A
 (CSA - 15A)

For Type SC-20 Fuses; 20A,
 600V (or less). Also fuse
 types BBS & KTQ (nominal
 size $1\frac{3}{32}'' \times 1\frac{3}{8}''$).

Data Sheet: 2124



HEC Series
In-Line Fuseholders
Single-Pole
Voltage Rating: 480V, 30A
Non-Breakaway Holders

For SC-25, & SC-30 Fuses
 Fuse size $1\frac{3}{32}'' \times 1\frac{5}{8}''$.

Data Sheet: 2124



HEJ Series
In-Line Fuseholders
Single-Pole
Non-Breakaway Holders
Voltage Rating: 480V, 60A

For SC Fuses; 35A to 60A and
 Type HWW fuses, $\frac{1}{2}$ to 6A.
 Fuse size $1\frac{3}{32}'' \times 2\frac{1}{4}''$.

Data Sheet: 2123

Single Pole

$1\frac{3}{32}'' \times 1\frac{1}{2}''$ Fuses



HEB Series
In-Line Fuseholders
Single-Pole
Voltage Rating: 600V, 30A

For any $1\frac{3}{32}'' \times 1\frac{1}{2}''$ fuse.
 Typical fuse types: BAF, FNM,
 FNQ, and KTK ($\frac{1}{10}$ - 30A).

Data Sheet: 2127



HET Series
In-Line Fuseholders
Single-Pole

An HEB - Fuseholder with a
 permanently installed solid
 neutral. Easily identified by
 white plastic coupling nut.

Data Sheet: 2125

Double Pole

KTK-R Fuses



HEY Series
In-Line Fuseholders
Double-Pole
Voltage Rating: 600V, 30A

Optional Break-a-way recep-
 tacle, polarized, and accepting
 Class CC branch circuit fuses
 (Buss type KTK-R, FNQ-R &
 LP-CC; 600V or less, 200,000A
 interrupting rating).

Data Sheet: 2126

$1\frac{3}{32}'' \times 1\frac{1}{2}''$ Fuses



HEX Series
In-Line Fuseholders
Double-Pole
Voltage Rating: 600V, 30A

For any $1\frac{3}{32}'' \times 1\frac{1}{2}''$ fuse.
 Typical fuse types: BAF, FNM,
 FNQ, and KTK ($\frac{1}{10}$ - 30A).

Data Sheet: 2126

Note: For agency and CE information see the appropriate data sheet.



For HEB Holders Only

Directions: To select complete holder P/N, work from left to right starting with load terminal options and then line terminal options. Then determine breakaway or non-breakaway style.

					Line Terminal					Available P/N's	
Terminal Type	Wire Size	No. of Wires per Terminal	Solid Wire	Stranded Wire	Terminal Type	Wire Size	No. of Wires per Terminal	Solid Wire	Stranded Wire	Non-Breakaway P/N (Boots not included)	Breakaway P/N (Boots included)
Copper Crimp	#12 to #8 #12	1 2	Y Y	Y Y	Copper Crimp	#12 to #8 #12	1 2	Y Y	Y Y	HEB-AA ⁽¹⁾⁽²⁾ ₍₃₎	HEB-AW-RLC-A ⁽¹⁾⁽²⁾ ₍₃₎
Copper Crimp	#12 to #8 #12	1 2	Y Y	Y Y	Copper Crimp	#6 to #4 #10	1 2	Y Y	Y Y	HEB-AB ⁽²⁾	HEB-AW-RLC-B
Copper Crimp	#12 to #8 #12	1 2	Y Y	Y Y	Copper Crimp	#4 #8	1 2	N Y	Y Y	HEB-AC ⁽²⁾	HEB-AW-RLC-C
Copper Crimp	#12 to #8 #12	1 2	Y Y	Y Y	Copper Crimp	#2 #6	1 2	N Y	Y Y	HEB-AD ⁽²⁾	N/A
Copper Crimp	#12 to #8 #12	1 2	Y Y	Y Y	Copper Crimp	2/0 #3	1 2	N N	Y Y	HEB-AE ⁽²⁾	N/A
Copper Crimp	#12 to #8 #12	1 2	Y Y	Y Y	Copper Set-Screw	#12 to #3	1	Y	Y	HEB-AJ	HEB-AW-RLC-J
Copper Crimp	#12 to #8 #12	1 2	Y Y	Y Y	Copper set-screw	#12 to #3	2	Y	Y	HEB-AK	HEB-AW-RYC
Copper Crimp	#12 to #8 #12	1 2	Y Y	Y Y	Aluminum Set-Screw	#12 to #2	1	Y	Y	HEB-AL	HEB-AW-RLA
Copper Crimp	#12 to #8 #12	1 2	Y Y	Y Y	Aluminum Set-Screw	#12 to #2	2	Y	Y	HEB-AY	HEB-AW-RYA
Copper Crimp	#12 to #8 #12	1 2	Y Y	Y Y	Aluminum Crimp	#1, #2	1	N	Y	HEB-AR	N/A
Copper Crimp	#6, #4 #10	1 2	Y Y	Y Y	Copper Crimp	#12 to #8 #12	1 2	Y Y	Y Y	HEB-BA ⁽²⁾	HEB-BW-RLC-A
Copper Crimp	#6, #4 #10	1 2	Y Y	Y Y	Copper Crimp	#6, #4 #10	1 2	Y Y	Y Y	HEB-BB ⁽²⁾	HEB-BW-RLC-B
Copper Crimp	#6, #4 #10	1 2	Y Y	Y Y	Copper Crimp	#4 #8	1 2	N Y	Y Y	HEB-BC ⁽²⁾	N/A
Copper Crimp	#6, #4 #10	1 2	Y Y	Y Y	Copper Crimp	#2 #6	1 2	N Y	Y Y	HEB-BD ⁽²⁾	N/A
Copper Crimp	#4 #8	1 2	N Y	Y Y	Copper Crimp	#4 #8	1 2	N Y	Y Y	HEB-CC ⁽²⁾	N/A
Copper Crimp	#2 #6	1 2	N Y	Y Y	Copper Crimp	#2 #6	1 2	N Y	Y Y	HEB-DD ⁽²⁾	N/A
Copper Crimp	#20, #18	1	Y	Y	Copper Crimp	#12 to #8 #12	1 2	Y Y	Y Y	HEB-ZA	N/A
Copper Set-Screw	#12 to #3	1	Y	Y	Copper Set-Screw	#12 to #3	1	Y	Y	HEB-JJ	HEB-JW-RLC-J
Copper Set-Screw	#12 to #3	1	Y	Y	Copper Set-Screw	#12 to #3	2	Y	Y	HEB-JK	HEB-JW-RYC
Copper Set-Screw	#12 to #3	1	Y	Y	Aluminum Set-Screw	#12 to #2	1	Y	Y	HEB-JL	N/A
Copper Set-Screw	#12 to #3	1	Y	Y	Aluminum Set-Screw	#12 to #2	2	Y	Y	HEB-JY	N/A
Aluminum Set-Screw	#12 to #2	1	Y	Y	Aluminum Set-Screw	#12 to #2	1	Y	Y	HEB-LL	HEB-LW-RLA
Aluminum Crimp	#8 #6	1 1	N Y	Y N	Aluminum Crimp	#8 #6	1 1	N Y	Y N	HEB-NN	N/A
Aluminum Crimp	#6 #4	1 1	N Y	Y N	Aluminum Crimp	#6 #4	1 1	N Y	Y N	HEB-PP ⁽²⁾	N/A
Aluminum Crimp	#3, #4 #2	1 1	N Y	Y N	Aluminum Crimp	#3, #4 #2	1 1	N Y	Y N	HEB-QQ ⁽²⁾	N/A
Aluminum Crimp	#1, #2	1	N	Y	Aluminum Crimp	#1, #2	1	N	Y	HEB-RR ⁽²⁾	N/A
Aluminum Crimp	1/0	1	N	Y	Aluminum Crimp	1/0	1	N	Y	HEB-TT ⁽²⁾	N/A
Solid Terminal for aluminum connector	#8 to #12 #10 to #14	1 1	Y N	N Y	Solid Terminal for aluminum connector	#8 to #12 #10 to #14	1 1	Y N	N Y	HEB-SS	N/A

(1)UL Recognized, Guide 12LT2, File E14853

(2)CSA Certified, Class 6225-01, File 47235

(3)CE

Contact your local Bussmann representative for other



In-Line Fuseholders for Automotive Blade-Type Fuses



HHC, HHD, HHF and HHG In-Line Fuseholders for ATC® Blade-Type Fuses

Voltage Rating: 32Vdc

Current Rating: See Table. Rated to carry 80% of Fuse Rating continuously.

Electrical Ratings

Catalog Symbol	Description	Fuse Size	Electrical Connection
HHC	Yellow fuseholder	3-20A	#16 black leadwire
HHD	Black fuseholder	3-30A	#12 yellow leadwire
HHD-C	Cover only	Fits HHD only	Clear polycarbonate
HHF	Black fuseholder with cover	3-20A	#16 yellow leadwire
HHG	Black fuseholder with cover	3-30A	#12 yellow leadwire

Bulk Products

(Bulk Quantity - 1000 Pieces)

Catalog Symbol	Description	Fuse Size	Electrical Connection
BK/HHC-R	Yellow fuseholder	3-20A	#16 red leadwire
BK/HHF-B	Black fuseholder with cover	3-20A	#16 black leadwire

A fuse must be properly and fully inserted into the holder to provide a solid connection. Poor or improper insertion of the fuse can result in failure of the fuse and holder, thus not protecting the device for which it was intended.

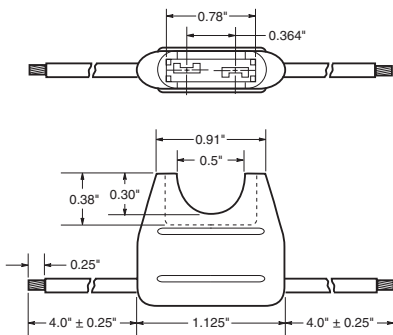

Data Sheet: 2107



HHL and HHM In-Line Fuseholders for MINI-Fuses®

Voltage Rating: 32Vdc

Current Rating: See Table. Rated to carry 80% of Fuse Rating continuously.

Electrical Ratings

Catalog Symbol	Description	Fuse Size	Electrical Connection
HHL	Black fuseholder w/cover	2-20A	#16 black leadwire, 4" length stripped to 1/4"
HHL-B	Black fuseholder - body only	2-20A	#16 black leadwire, 4" length stripped to 1/4"
HHM	Black fuseholder w/cover	2-30A	#12 red leadwire, 4" length stripped to 1/4"
HHM-B	Black fuseholder - body only	2-30A	#12 red leadwire, 4" length stripped to 1/4"
HHM-C	Black cover only		

Bulk Products

(Bulk Quantity - 1000 Pieces)

Catalog Symbol	Description	Fuse Size	Electrical Connection
BK/HHL-R	Black fuseholder - body only	2-20A	#16 red leadwire, 4" length stripped to 1/4"

A fuse must be properly and fully inserted into the holder to provide a solid connection. Poor or improper insertion of the fuse can result in failure of the fuse and holder, thus not protecting the device for which it was intended.

Data Sheet: 2128



HHX In-Line Fuseholders for MAXI-Fuses™

Voltage Rating: 32Vdc

Current Rating: See Table. Rated to carry 80% of Fuse Rating continuously.

Electrical Ratings

Catalog Symbol	Description	Fuse Size	Electrical Connection
HHX	Black fuseholder w/cover	20-60A	#6 red leadwire, 5" with blunt ends
HHX-B	Black fuseholder - body only	20-60A	#6 red leadwire, 5" with blunt ends
HHX-C	Black cover only		

A fuse must be properly and fully inserted into the holder to provide a solid connection. Poor or improper insertion of the fuse can result in failure of the fuse and holder, thus not protecting the device for which it was intended.

Data Sheet: 2129



For 1/4" × 1 1/4" Fuses



Series 8000

Bolt-in and Snap-in Mounting for 1/4" × 1 1/4" Fuses

Construction: Blocks are molded flame retarded thermoplastic. Clips are spring-bronze.

Voltage Rating: 300V

Agency Information:

UL Recognized ; File E14853A, Guide IZLT2

CSA Certified Class 6225-01, File 47235

Anti-Rotation Pin: Single pole blocks may be ordered without the antirotational pin simply by adding an "X" to the number of poles (Example: BK/S-8000-1X).

Carton Quantity: 10; shelf package: 100.

Bulk Carton: Single-pole and 2-pole fuse blocks—1,000; Multiple-pole fuse blocks—3-8 pole: 200; 9-12 pole: 50. When ordering bulk quantities, prefix "BK/" to catalog number: (Example: BK/S-8001-1-SNP).

Bolt-in Mounting

Series	Terminal	Angle	Basic Cat. No.	Amperes	Poles (Suffix)
8000	Solder	0°	S-8001-	UL 25A	1 - 12
		40°	S-8002-	CSA 21A	
8100	3/16" Quick Connect	0°	S-8101-	UL 20A	
		40°	S-8102-	CSA 13A	
8200	1/4" Quick Connect	0°	S-8201-	UL 20A	
		40°	S-8202-	CSA 16A	
		Side	S-8203-	CSA 16A	
8300	Screw	—	S-8301-	UL 30A CSA 25A	

Snap-in Mounting

Series	Terminal	Angle	Cat. No.	Amperes	Poles (Suffix)
8000	Solder	0°	S-8001-1-SNP	UL 25A	Available only in single pole
		40°	S-8002-1-SNP	CSA 21A	
8100	3/16" Quick Connect	0°	S-8101-1-SNP	UL 20A	
		40°	S-8102-1-SNP	CSA 13A	
8200	1/4" Quick Connect	0°	S-8201-1-SNP	UL 20A	
		Side	S-8203-1-SNP	CSA 16A	

Catalog Code

BK/	S-8	0	00	-00
Prefix for Bulk Packing	Series 8000 Product Line	Type Terminal	Terminal Angle	Number of Poles (1-12)
		"0" - Solder	"01" - straight (0°)	
		"1" - 3/16" Quick Connect	"02" - 40°	
		"2" - 1/4" Quick Connect	"03" - side*	
		"3" - Screw		

*Available only in single pole



CE logo denotes compliance with European Union Low Voltage Directive (50-1000Vac, 75-1500Vdc). Refer to Data Sheet: 8002 or contact Bussmann Application Engineering at 636-527-1270 for more information.



4405

4406

1/4" × 1 1/4" Single Pole

(6.4mm × 31.8mm)

Bakelite base; spring-bronze, bright tin-lead plate clips; 30A, 250V; base width 1/2" (12.7mm).

No. 4405—0° Solder Terminals. Integral terminal and clip.

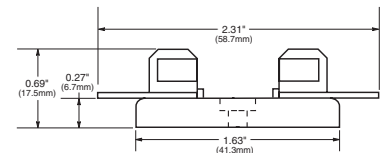

No. 4406—Side Solder Terminal

No. 4574—Spare Fuseblock

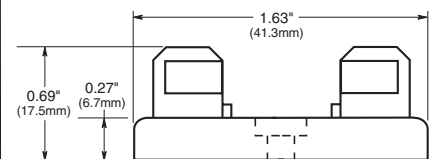

No. 2499—Side Quick-Connect Terminals. 1/4" (6.4mm); 15A, 250V. UL Recognized, Guide IZLT2, File E14853.

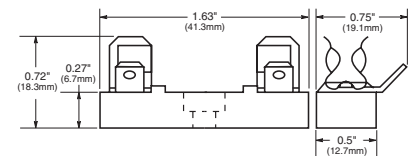

Note—Mounting screw hole diameter is 0.147" (3.7mm). Counterbore diameter, 0.636" (8.0mm). Max. Mounting Screw No. 6.



2499

4574

Data Sheet: 2101



For complete specification data, call Bussmann Information Fax ~ 636.527.1450

For 1/4" x 1" Fuses



Series 3828
Solder Terminals Fuseblock for 1/4" x 1" Fuses
 (6.4mm x 25.4mm)

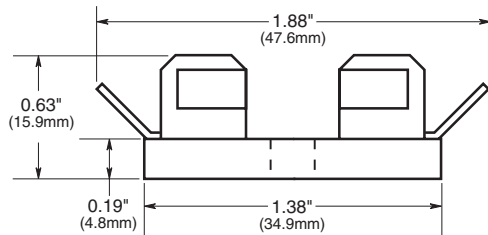

Catalog And Dimensional Data

Catalog Number	No. of Poles	*Base Length	
		inches	mm
3828-1	1	1/2	12.7
3828-2	2	1 1/8	28.6
3828-3	3	1 3/4	44.5
3828-4	4	2 3/8	60.3
3828-5	5	3	76.2
3828-6	6	3 5/8	92.1
3828-7	7	4 1/4	108.0
3828-8	8	4 7/8	123.8
3828-10	10	6 1/8	155.6
3828-12	12	7 3/8	187.3

*Small phenolic base, base width 1 3/8" (34.9mm)

Note—Mounting screw hole diameter is 0.147" (3.7mm) Max. Mounting Screw No. 6.



4520 and 4393
Single Pole Fuseblock for 1/4" x 1" Fuses

Bakelite base; Width 1/2" (12.7mm). Spring-bronze, bright tin-lead plated clips. Rated 30A, 250V.

No. 4520—Solder terminals; straight; integral clip and terminal.

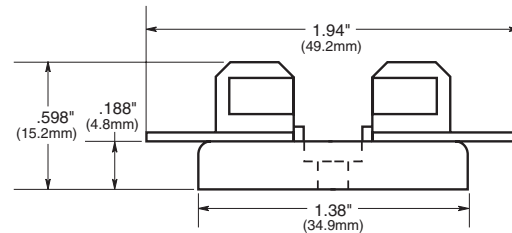

No. 4393—Spare fuseblock.

Note—Mounting screw hole diameter is 0.147" (3.7mm), counterbore 0.636" (8.0mm) diameter. Max. Mounting Screw No. 6.

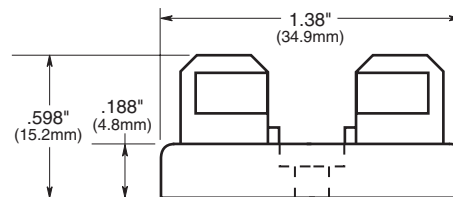

Printed Circuit Board for 5mm Diameter Fuses

HTC-15M, HTC-140M

PCB Fuseblock and Snap-On Cover

Voltage Rating: 250V, 6.3A, 1.6W

HTC-15M (Fuseholder), HTC-140M (Natural Cover),
HTC-150M* (Transparent Cover)

*Available in bulk only. Use this format: BK/HTC-150M

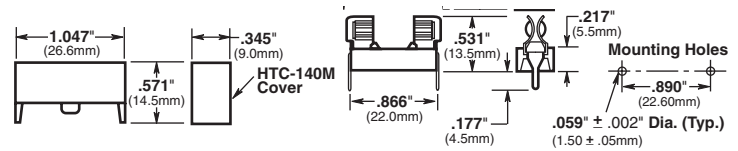

Data Sheet: 2110

HTC-200M

PC Board Mount Fuseclip

Construction: Tin plated bronze

Tape and Fan Fold packed

Ammo Pack (AP/HTC-200M) 1000 pieces per box

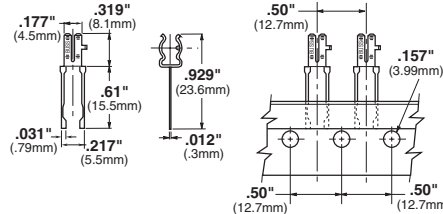

Data Sheet: 2110

HTC-210M

PC Board Mounted Fuseclip with End Stops

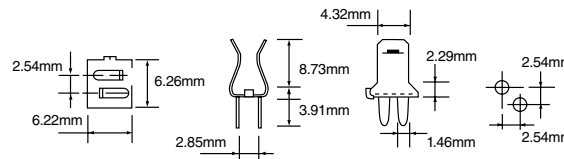

Data Sheet: 2110

1A3399 Series

Fuseclips with End Stops and Straight Leads

Catalog Number	Clip Material*	Finish
1A3399-01	Beryllium Copper*	Silver
1A3399-04	Beryllium Copper*	Bright Tin
1A3399-10	Spring Bronze	Bright Tin

*Beryllium copper recommended for currents higher than 15 amps (¼" clips).

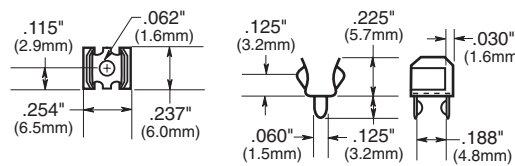

Data Sheet: 2131

1A5018 Series

Fuseclips with End Stops and Straight Leads

High Profile

Catalog Number	Clip Material*	Finish
1A5018-7	Spring Bronze	Silver
1A5018-10	Spring Bronze	Bright Tin

*Beryllium copper recommended for currents higher than 15 amps (¼" clips).

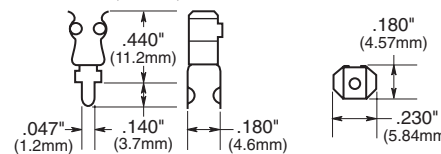

Data Sheet: 2131

1A5601 Series

Fuseclips (0-7A)

Catalog Number	Clip Material	Finish
1A5601	Cartridge Brass	Bright Tin

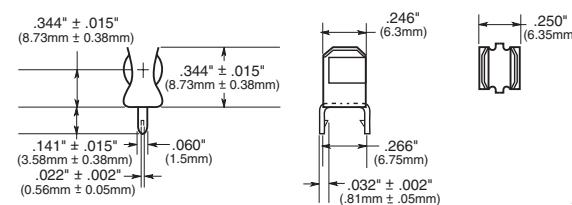

Data Sheet: 2131

1A5602 Series

Fuseclips (0-7A)

Catalog Number	Clip Material	Finish
1A5602	Cartridge Brass	Bright Tin

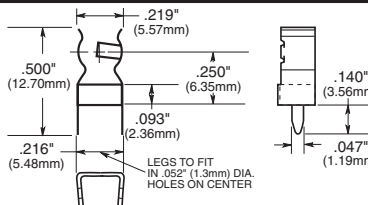

Data Sheet: 2131



Printed Circuit Board for 1/4" Diameter Fuses

1A3398 Series

Fuseclips without End Stops and Straight Leads

Catalog Number	Clip Material	Finish
1A3398-07	Cartridge Brass	Bright Tin
1A3398-08	Spring Bronze	Bright Tin

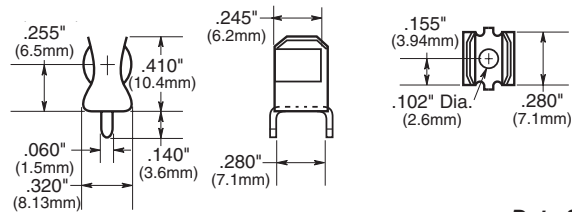

Data Sheet: 2131

1A1907 Series

Fuseclips with End Stops and Straight Leads

Catalog Number	Clip Material*	Finish
1A1907-02	Cartridge Brass	None/Bright Dipped
1A1907-03	Beryllium Copper*	Bright Tin
1A1907-05	Beryllium Copper*	Silver
1A1907-06	Cartridge Brass	Bright Tin
1A1907-08	Spring Bronze	None/Bright Dipped
1A1907-09	Spring Bronze	Bright Tin

*Beryllium copper recommended for currents higher than 15A (1/4" clips).

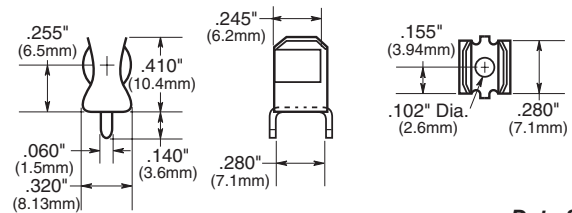

Data Sheet: 2131

1A4533 Series

Fuseclips without End Stops and Angled Out Leads

Catalog Number	Clip Material*	Finish
1A4533-01	Beryllium Copper*	Bright Tin
1A4533-06	Cartridge Brass	Bright Tin
1A4533-07	Spring Bronze	Bright Tin

*Beryllium copper recommended for currents higher than 15A (1/4" clips).

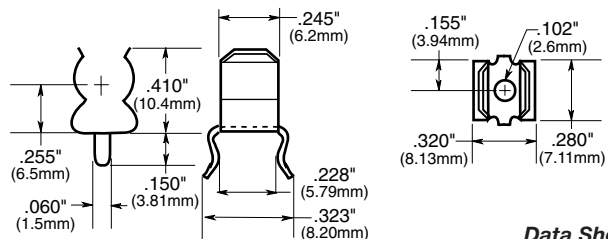

Data Sheet: 2131

1A4534 Series

Fuseclips with End Stops and Angled Out Leads

Catalog Number	Clip Material*	Finish
1A4534-01	Beryllium Copper*	Bright Tin
1A4534-06	Cartridge Brass	Bright Tin
1A4534-07	Spring Bronze	Bright Tin

*Beryllium copper recommended for currents higher than 15A (1/4" clips).

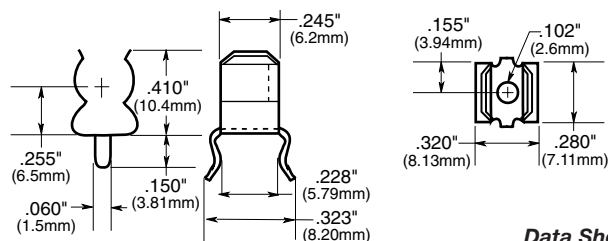

Data Sheet: 2131

1A1120 Series

Fuseclips without End Stops and Angled In Leads

Catalog Number	Clip Material*	Finish
1A1120-02	Cartridge Brass	None/Bright Dipped
1A1120-05	Beryllium Copper*	Silver
1A1120-06	Beryllium Copper*	Bright Tin
1A1120-09	Cartridge Brass	Bright Tin
1A1120-11	Spring Bronze	None/Bright Dipped
1A1120-12	Spring Bronze	Bright Tin

*Beryllium copper recommended for currents higher than 15A (1/4" clips).

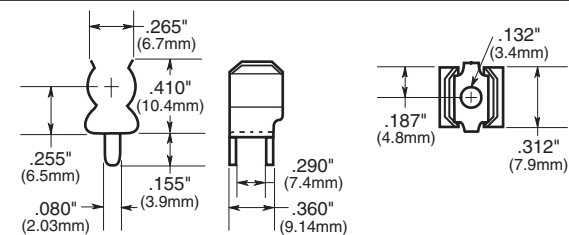

Data Sheet: 2131

1A1119 Series

Fuseclips with End Stops and Angled In Leads

Catalog Number	Clip Material*	Finish
1A1119-04	Beryllium Copper*	Bright Tin
1A1119-05	Beryllium Copper*	Silver
1A1119-10	Cartridge Brass	Bright Tin
1A1119-13	Spring Bronze	Bright Tin

*Beryllium copper recommended for currents higher than 15A (1/4" clips).

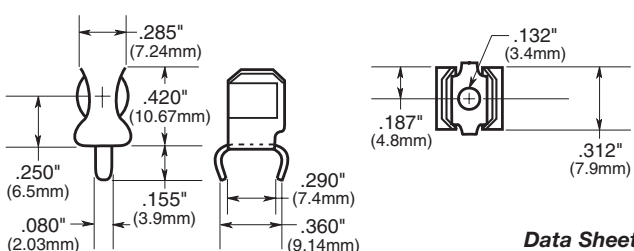

Data Sheet: 2131



Printed Circuit Board Fuseclips

1A3400 Series

Fuseclips for $1\frac{3}{32}$ " diameter fuses with End Stops and Straight Leads

Catalog Number	Clip Material	Finish
1A3400-09	Spring Bronze	Bright Tin
20A Maximum		

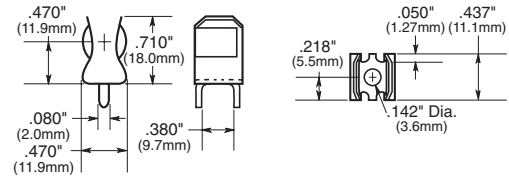

Data Sheet: 2131

1A5600 Series

Fuseclips for ATC® Fuses (0-20A)

Catalog Number	Clip Material	Finish
1A5600	Brass	Satin Finish Tin

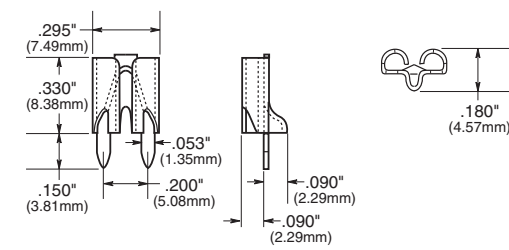

Data Sheet: 2131



Printed Circuit Board Fuseclips

5681 & 5682 Series Fuseclips with Mounting Holes For 1/4" Diameter Fuses

				Dimensions (Inches)					
Catalog Number	End Stop	Clip Mat.**	Finish	B (To End Stop)	C (Contact)	D (Height)	E (Width)	Hole Dia.	Fig. Ref.
5681-08	No	Spg. Br.	Nickel	†	.265	.410	.320	.132	2
5681-15		Spg. Br.	Bright Tin						
5682-01		BeCU	Silver	.106	.260	.410	.320	.132	1
5682-02	Yes	BeCU	Silver	.132					
5682-41		Spg. Br.	Bright Tin	.106					
5682-44		Spg. Br.	Bright Tin	.132					

Data Sheet: 2132

5672 & 5674 Series Fuseclips with Mounting Holes For 3/32" Diameter Fuses

				Dimensions (Inches)					
Catalog Number	End Stop	Clip Mat.**	Finish	B (To End Stop)	C (Contact)	D (Height)	E (Width)	Hole Dia.	Fig. Ref.
5672-11	No	Spg. Br.	Bright Tin	†	.362	.520	.380	.172	2
5674-01		BeCU	Silver	.168	.356	.520	.380	.172	1
5674-10	Yes	BeCU	Albaloy						
5674-41		Spg. Br.	Bright Tin						

Data Sheet: 2132

5956 & 5960 Series Fuseclips with Mounting Holes For 13/32" Diameter Fuses

				Dimensions (Inches)					
Catalog Number	End Stop	Clip Mat.**	Finish	B (To End Stop)	C (Contact)	D (Height)	E (Width)	Hole Dia.	Fig. Ref.
5956-16	No	Spg. Br.	Bright Tin	†	.312	.710	.470	.172	2
5960-07		BeCU	Silver	.168	.389	.710	.470	.196	1
5960-09		BeCU	Silver	.200				.172	
5960-23		BeCU	Albaloy	.168				.196	
5960-51	Yes	Spg. Br.	Bright Dip*	.168				.196	
5960-53		Spg. Br.	Bright Dip*	.200				.172	
5960-61		Spg. Br.	Bright Tin	.168				.196	
5960-62		Spg. Br.	Bright Tin	.168				.132	
5960-63		Spg. Br.	Bright Tin	.200				.172	
5960-64		Spg. Br.	Bright Tin	.200				.128	

Data Sheet: 2132

5591 & 5592 Series Fuseclips with Mounting Holes For 9/16" Diameter Fuses

				Dimensions (Inches)					
Catalog Number	End Stop	Clip Mat.**	Finish	B (To End Stop)	C (Contact)	D (Height)	E (Width)	Hole Dia.	Fig. Ref.
5591-42	Yes	Spg. Br.	Bright Dip*	.260	.510	.890	.600	.172	1
5592-01		BeCU	Silver	†	.505	.890	.600	.200	2
5592-11	No	Spg. Br.	Silver					.200	
5592-33		Spg. Br.	Bright Dip*					.172	

* Bright Dip is actually treated bare metal with no plating.
 ** Spg. Br. — Spring Bronze; BeCU — Beryllium Copper.
 † Hole in center of both clip and contact area.

1A1837 For 13/16" Diameter Fuses

Data Sheet: 2132

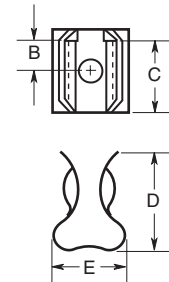

FIGURE 1

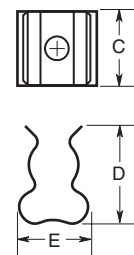

FIGURE 2



Rail Mount Terminal Blocks

Series NDN

35mm DIN Rail Compatible

High Density Design: Up to 48 circuits per foot

Clamping Collar: Secures wires

Large, Captive, Wire-ready Screws: Speeds assembly

Snap-on Installation to DIN Rail: Fast, easy assembly

Fully Shielded Construction: 600V spacings

Unique One-piece Construction: Increases reliability

Thermoplastic Moldings: Strong and impact resistant

Material: UL Recognized 94V-2 thermoplastic

Collars: Heat treated stainless steel

Terminals: Tin plated copper alloy

Screws: Zinc plated steel

Agency Information: UL E62622; CSA LR15364



NDNV4-__ (color)

Ratings: NDNV4 30A, 600V; UL/CSA

Center Spacing: .250" (6.35)

Number of Poles: 4

Circuits per Foot: 48

Circuit Jumper: JN4, 4 circuits

Wire Size: AWG #10-22 CU

Screw Size: #6-32

Mounting Options: 35mm DIN rail,
C-rail

Marking Tape: MTC6

Torque Rating: 18 in/lb max.

NDNV4 Colors: YE - Yellow
WH - White



NDN3-__ (color)

Ratings: 30A - field wiring;

40A - factory wiring 600V; UL/CSA

Center Spacing: .300" (7.62)

Number of Poles: 3

Circuits per Foot: 38

Circuit Jumper: JNDN3, 2 circuits

Wire Size: AWG #10-22 CU

Screw Size: #6-32

Mounting Options: 35mm DIN rail,
C-rail

Marking Tape: MT12-1/2

Torque Rating: 18 in/lb max.

NDN3 Colors: YE - Yellow
WH - White



NDN63-__ (color)

Ratings: 65A, 600V; UL/CSA

Center Spacing: .375" (9.52)

Number of Poles: 3

Circuits per Foot: 30

Circuit Jumper: JN3, 2 circuits

Wire Size: AWG #6-18 CU

Screw Size: #10-32

Mounting Options: 35mm DIN rail,
C-rail

Marking Tape: MT12-1/2

Torque Rating: 35 in/lb max.

NDN63 Colors: YE - Yellow
WH - White

CE CE logo denotes compliance with European Union Low Voltage Directive (50-1000Vac, 75-1500Vdc). Refer to Data Sheet: 8002 or contact Bussmann Application Engineering at 636-527-1270 for more information.

CE CE logo denotes compliance with European Union Low Voltage Directive (50-1000Vac, 75-1500Vdc). Refer to Data Sheet: 8002 or contact Bussmann Application Engineering at 636-527-1270 for more information.

CE CE logo denotes compliance with European Union Low Voltage Directive (50-1000Vac, 75-1500Vdc). Refer to Data Sheet: 8002 or contact Bussmann Application Engineering at 636-527-1270 for more information.



Rail Mount Terminal Blocks



NDN1-WH

Ratings: 90A, 600V
Center Spacing: .635" (16.13)
Number of Poles: 1
Circuits per Foot: 18
Circuit Jumper: JN1, 2 circuits
Wire Size: AWG #2-18 CU
Screw Size: ¼-28
Mounting Options: 35mm DIN rail, C-rail (Dove-tail option is available for mounting side-by-side. Order part no. NDN1A-WH.)
Marking Tape: MT12-½
Torque Rating: 32 in/lb max.
NDN1Colors: WH-White

CE CE logo denotes compliance with European Union Low Voltage Directive (50-1000Vac, 75-1500Vdc). Refer to Data Sheet: 8002 or contact Bussmann Application Engineering at 636-527-1270 for more information.



NDN111-__ __ (color)

Ratings: 90A, 600V; UL/CSA
Center Spacing: .635" (16.13)
Number of Poles: 3
Circuits per Foot: 18
Circuit Jumper: JN1, 2 circuits
Wire Size: AWG #2-18 CU
Screw Size: ¼-28
Mounting Options: 35mm DIN rail, C-rail, Base Mount. (Dove tail option is available for mounting side-by-side. Order part no. NDN111A-WH.)

Marking Tape: MT12-½
Torque Rating: 32 in/lb max.
NDN111 Colors: YE - Yellow, WH - White
NDN111A Colors: YE - Yellow, WH - White

CE CE logo denotes compliance with European Union Low Voltage Directive (50-1000Vac, 75-1500Vdc). Refer to Data Sheet: 8002 or contact Bussmann Application Engineering at 636-527-1270 for more information.

Series NDN Terminal Block Accessories

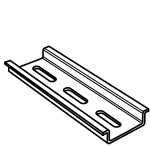

NDNA
 35mm DIN rail
 Aluminum
NDNA 100 1 meter
NDNA 200 2 meters

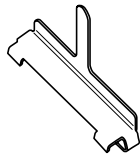

NDNAS
 35mm DIN rail
 End Stop

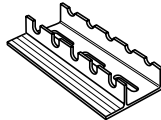

NFTA
 C-rail
 Aluminum
 NFTA36 36" long
 NFTA72 72" long

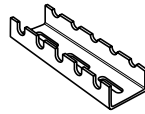

NRA37-½
 C-rail
 Low profile
 No flange
 Aluminum
 37½" length

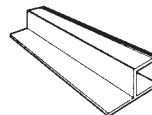

SOA72
 72" long
 Stand-Off Channel
 for C-rail

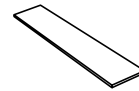

MARKING TAPE
 See series specifications

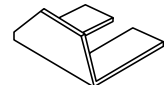

JUMPERS
 See series specifications



Rail Mount Terminal Blocks



N512-BK
Ratings: 5A, 600V; UL/CSA 20A, 300V; UL/CSA
Center Spacing: .197" (5.00)
Number of Poles: 12
Circuits per Foot: 60
Circuit Jumper: JN512, 12 circuits
Wire Size: AWG #12-22 CU
Screw Size: #4-48
Mounting Options: C-rail, 15mm DIN rail
Marking Tape: AT512
Torque Rating: 12 in/lb max.
Color: Black-BK

CE CE logo denotes compliance with European Union Low Voltage Directive (50-1000Vac, 75-1500Vdc). Refer to Data Sheet: 8002 or contact Bussmann Application Engineering at 636-527-1270 for more information.

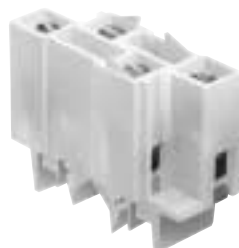

NFT2- (color)
Ratings: 40A, 600V; UL/CSA; 55A factory wired.
Center Spacing: .281" (7.13)
Number of Poles: 2
Circuits per Foot: 38
Circuit Jumper: JN2, 2 circuits
Wire Size: AWG #8-22 CU
Screw Size: #8-32
Mounting Options: C-rail
Marking Tape: MT12-1/2
Torque Rating: 18 in/lb max.
NFT2 Colors: WH - White

CE CE logo denotes compliance with European Union Low Voltage Directive (50-1000Vac, 75-1500Vdc). Refer to Data Sheet: 8002 or contact Bussmann Application Engineering at 636-527-1270 for more information.

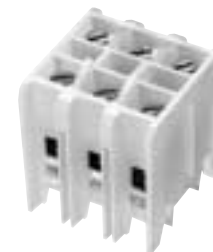

NFT3- (color)
Ratings: 40A, 600V; UL/CSA; 55A factory wired.
Center Spacing: .390" (9.91)
Number of Poles: 3
Circuits per Foot: 28
Circuit Jumper: JN3, 2 circuits
Wire Size: AWG #8-22 CU
Screw Size: #8-32
Mounting Options: C-rail
Marking Tape: MT12-1/2
Torque Rating: 18 in/lb max.
NFT3 Colors:
 YE - Yellow WH - White

CE CE logo denotes compliance with European Union Low Voltage Directive (50-1000Vac, 75-1500Vdc). Refer to Data Sheet: 8002 or contact Bussmann Application Engineering at 636-527-1270 for more information.



NC3-WH
Ratings: 175A, 600V; UL/CSA
Center Spacing: 1.06" (26.92)
Number of Poles: 3
Circuits per Foot: 11
Wire Size: 2/0-#14 CU/AL
Screw Size: 5/16-24
Mounting Options: C-rail, Base Mount
Marking Tape: MT12-1/2
Torque Rating: 45 in/lb max.
NC3 Colors: WH - White

CE CE logo denotes compliance with European Union Low Voltage Directive (50-1000Vac, 75-1500Vdc). Refer to Data Sheet: 8002 or contact Bussmann Application Engineering at 636-527-1270 for more information.



NSE3-WH
Ratings: 115A, 600V; UL/CSA
Center Spacing: 1.06" (26.92)
Number of Poles: 3
Circuits per Foot: 11
Wire Size: For use with wire crimped to ring terminal.
Screw Size: 1/4-28
Mounting Options: C-rail, Base Mount
Marking Tape: MT12-1/2

CE CE logo denotes compliance with European Union Low Voltage Directive (50-1000Vac, 75-1500Vdc). Refer to Data Sheet: 8002 or contact Bussmann Application Engineering at 636-527-1270 for more information.



NSS3-WH
Ratings: 30A, 600V; UL/CSA
Center Spacing: .385" (9.77)
Number of Poles: 3
Circuits per Foot: 28
Circuit Jumper: JNSS3, 2 circuits
Wire Size: For use with wire crimped to ring terminal.
Screw Size: #6-32
Mounting Options: C-rail
Marking Tape: MT12-1/2
NSS3 Colors: WH - White

CE CE logo denotes compliance with European Union Low Voltage Directive (50-1000Vac, 75-1500Vdc). Refer to Data Sheet: 8002 or contact Bussmann Application Engineering at 636-527-1270 for more information.



Sectional Terminal Blocks



PLU3- (color)
Depluggable Rail Mount
Ratings: 40A, 600V; UL/CSA
Center Spacing: .390" (9.91)
Number of Poles: 3
Circuits per Foot: 28
Circuit Jumper: JN3, 2 circuits
Wire Size: AWG #8-22 CU
Screw Size: #8-32
Mounting Options: C-rail, Stackable
Marking Tape: MT12-1/2
Torque Rating: 18 in/lb max.
PLU3 Colors: YE - Yellow
 WH - White

CE logo denotes compliance with European Union Low Voltage Directive (50-1000Vac, 75-1500Vdc). Refer to Data Sheet: 8002 or contact Bussmann Application Engineering at 636-527-1270 for more information.



PLU1-WH
Depluggable Rail Mount
Ratings: 70A, 600V; UL/CSA
Center Spacing: .625" (15.88)
Number of Poles: PLU1-WH (1 pole);
 PLU11-WH (2 poles); PLU111-WH (3 poles)
Circuits per Foot: 19
Circuit Jumper: JN1, 2 circuits
Wire Size: AWG #4-18 CU
Screw Size: 1/4-28
Mounting Options: C-rail, Stackable
Marking Tape: MT12-1/2
Torque Rating: 32 in/lb max.
PLU1 Colors: WH-White
PLU11 Colors: WH-White
PLU111 Colors: WH-White

CE logo denotes compliance with European Union Low Voltage Directive (50-1000Vac, 75-1500Vdc). Refer to Data Sheet: 8002 or contact Bussmann Application Engineering at 636-527-1270 for more information.

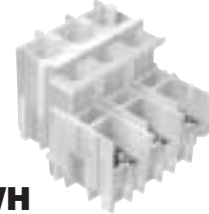

PSU1-WH
Depluggable Rail Mount
Ratings: 45A*, 600V; UL/CSA
 (*45A rating achieved with ring terminal crimped to wire)
Center Spacing: .625" (15.88)
Number of Poles: PSU1-WH (1 pole);
 PSU11-WH (2 poles); PSU111-WH (3 poles)
Circuits per Foot: 19
Wire Size: For use with crimp on connectors only.
Screw Size: #10-32
Mounting Options: C-rail, Stackable
Marking Tape: MT12-1/2
Torque Rating: 32 in/lb max.
PSU1 Colors: WH-White
PSU11 Colors: WH-White
PSU111 Colors: WH-White

CE logo denotes compliance with European Union Low Voltage Directive (50-1000Vac, 75-1500Vdc). Refer to Data Sheet: 8002 or contact Bussmann Application Engineering at 636-527-1270 for more information.



KT3-WH
Base Mount
Ratings: 40A, 600V; UL/CSA
Center Spacing: .390" (9.91)
Number of Poles: 3
Circuits per Foot: 28
Circuit Jumper: JN3, 2 circuits
Wire Size: #8-22 CU
Screw Size: #8-32
Mounting Options: Base Mount, Stackable. KAD end mount adapter optional.
Marking Tape: MT12-1/2
Torque Rating: 18 in/lb max.
KT3 Colors: WH-White

CE logo denotes compliance with European Union Low Voltage Directive (50-1000Vac, 75-1500Vdc). Refer to Data Sheet: 8002 or contact Bussmann Application Engineering at 636-527-1270 for more information.



KT4-WH
Base Mount
Ratings: 30A, 600V; UL/CSA
Center Spacing: .250" (6.35)
Number of Poles: 4
Circuits per Foot: 48
Circuit Jumper: JN4, 4 circuits
Wire Size: AWG #10-22 CU
Screw Size: #6-32
Mounting Options: Base Mount. Mounting screws recommended every 12 circuits.
Marking Tape: MTC6
Torque Rating: 18 in/lb max.
KT4 Colors: WH-White

CE logo denotes compliance with European Union Low Voltage Directive (50-1000Vac, 75-1500Vdc). Refer to Data Sheet: 8002 or contact Bussmann Application Engineering at 636-527-1270 for more information.



PLK3- (color)
Base Mount
Ratings: 40A, 600V; UL
Center Spacing: .390" (9.91)
Number of Poles: 3
Circuits per Foot: 28
Circuit Jumper: JN3, 2 circuits
Wire Size: AWG #8-22 CU
Screw Size: #8-32
Mounting Options: Base Mount, Stackable. End Piece (Part No. KAD) is required for mounting. Mounting screws recommended every 15 circuits.
Marking Tape: MT12-1/2
Torque Rating: 18 in/lb max.
PLK3 Colors: YE - Yellow
 WH - White

CE logo denotes compliance with European Union Low Voltage Directive (50-1000Vac, 75-1500Vdc). Refer to Data Sheet: 8002 or contact Bussmann Application Engineering at 636-527-1270 for more information.



Quick Connect Terminal Blocks



NTQ23-WH

Ratings: 40A, 600V
Center Spacing: .390" (9.91)
Number of Poles: 3
Circuits per Foot: 28
Wire Size: AWG #8-22 CU
Screw Size: #8-32
Mounting Options: C-rail
Marking Tape: MT12-1/2
Color: White-WH
Torque Rating: 18 in/lb max.

CE CE logo denotes compliance with European Union Low Voltage Directive (50-1000Vac, 75-1500Vdc). Refer to Data Sheet: 8002 or contact Bussmann Application Engineering at 636-527-1270 for more information.



BNQ21-WH

Ratings: 40A, 600V; UL/CSA
Center Spacing: .437" (11.10)
Number of Poles: 1
Circuits per Foot: 24
Wire Size: AWG #8-22 CU
Screw Size: #8-32
Quick Connects: .250" x .031"
Mounting Options: Base Mount, Stackable. End Piece (Part No. BQE) is required for mounting. Mounting screws recommended every 8 circuits.
Torque Rating: 18 in/lb max.

CE CE logo denotes compliance with European Union Low Voltage Directive (50-1000Vac, 75-1500Vdc). Refer to Data Sheet: 8002 or contact Bussmann Application Engineering at 636-527-1270 for more information.



BQQ41-WH

Ratings: 30A, 600V; UL/CSA
Center Spacing: .437" (11.10)
Number of Poles: 1
Circuits per Foot: 24
Wire Size: For use with quick connect terminals only.
Quick Connects: .250" x .031"
Mounting Options: Base Mount, Stackable. End Piece (Part No. BQE) is required for mounting. Mounting screws recommended every 8 circuits.

CE CE logo denotes compliance with European Union Low Voltage Directive (50-1000Vac, 75-1500Vdc). Refer to Data Sheet: 8002 or contact Bussmann Application Engineering at 636-527-1270 for more information.



Rail Mount Fuseholders and Circuit Breakers



NDNF1-WH

Ratings: 30A, 600V; UL/CSA

Number of Poles: 1

Fuse Size: $1\frac{3}{32}$ " \times $1\frac{1}{2}$ "
(KTK, FNQ).

Circuit Jumper: JF1, 2 circuits

Wire Size: AWG #8-22 CU

Mounting Options: 35mm DIN rail,
C-rail

Marking Tape: MT12- $\frac{1}{2}$

Torque Rating: 18 in/lb max.

NDNF1 Colors: WH - White

Fuse Pullers (Optional):

PF1

Lighted neon or incandescent –
LPF-(Voltage rating)

LPF1-24

LPF1-120

LPF1-120-C

LPF1-220

LPF1-440

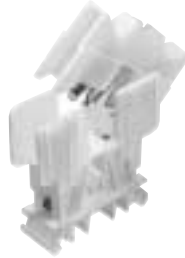

NDNLFD1

Ratings:

NDND1: 30A, 600V; UL/CSA (non-fused)

NDNFD1: 15A, 600V/CSA (fused)

NDNLFD1*: 15A, 600V (fused)

Number of Poles: 1

Fuse Size: $\frac{1}{4}$ " \times $1\frac{1}{4}$ "

(Buss® AGC, MDL or equivalent.)

Circuit Jumper: JF1, 2 circuits

Wire Size: AWG #8-22 CU

Mounting Options: 35mm DIN rail,
C-rail

Marking Tape: MT12- $\frac{1}{2}$

Torque Rating: 18 in/lb max.

Extension: WH - White

*WH24 - 24V White

(Only available with NDNLFD1)

CE CE logo denotes compliance with European Union Low Voltage Directive (50-1000Vac, 75-1500Vdc). Refer to Data Sheet: 8002 or contact Bussmann Application Engineering at 636-527-1270 for more information.



Power Distribution Blocks



Series 11675
Quick-Connect Power Distribution Block

Ratings: 40A, 250V; UL/CSA
Poles: 2 to 6 poles with (3) .250" quick-connect terminals per pole.
Input Wire Sizes: #8 – #14 CU
Torque Rating: 9 in/lb max.
Design: For equipment that requires screw connections in the field. Reduces assembly costs of internal wiring.
Agency Information: UL E62622; CSA LR15364

CE CE logo denotes compliance with European Union Low Voltage Directive (50-1000Vac, 75-1500Vdc). Refer to Data Sheet: 8002 or contact Bussmann Application Engineering at 636-527-1270 for more information.



Series 11725
Quick-Connect Power Distribution Block

Ratings: 70A, 600V; UL/CSA
Poles: 2, 3 or 4 poles with (4) .250" quick-connect terminals per pole.
Input Wire Sizes: #2 – #14 CU/#8 AL
Torque Rating: 45 in/lb max.
Design: For equipment that requires screw connections in the field. Reduces assembly costs of internal wiring.
Agency Information: UL E62622; CSA LR15364

CE CE logo denotes compliance with European Union Low Voltage Directive (50-1000Vac, 75-1500Vdc). Refer to Data Sheet: 8002 or contact Bussmann Application Engineering at 636-527-1270 for more information.



Series 14002
Barrier Terminal Block

Ratings: 115A, 600V; UL/CSA
Poles: 2 to 6 poles
Wire Sizes: #2 – #14 CU/#8 AL
Marking: Marking strip optional, consult factory.
Options For Load Side Connector:
 CP: Sems pressure plate, rated 60A, 600V
 Q: Quick-Connect, rated 50A, 600V
To order options, enter letter code in front of Part No.: ie; CP14002-2.
Agency Information: UL E62622; CSA LR15364

CE CE logo denotes compliance with European Union Low Voltage Directive (50-1000Vac, 75-1500Vdc). Refer to Data Sheet: 8002 or contact Bussmann Application Engineering at 636-527-1270 for more information.



Series 14004
Dead Front Terminal Block

Ratings: 90A, 600V; UL/CSA
Poles: 2 to 12 poles
Wire Sizes: #4 – #14 CU/#8 AL
Marking: Marking strip optional, consult factory.
Agency Information: UL E62622; CSA LR15364

CE CE logo denotes compliance with European Union Low Voltage Directive (50-1000Vac, 75-1500Vdc). Refer to Data Sheet: 8002 or contact Bussmann Application Engineering at 636-527-1270 for more information.



Power Distribution & Terminal Blocks



Series 160, 162, 163 & 165

Ratings: To 840A, 600V; UL Recognized/CSA. See Table.

Materials: Molded material: Black, UL rated 94V-0 thermoplastic.

Agency Information: UL E62622 General Industrial Class per UL 1059; CSA LR15364.

Power Distribution Blocks (600V) Catalog Data

Part Number	Line Connection	Load Connection	Connector Material & Ampacity	Agency Information
*16021	2/0-#14CU, 2/0-#8AL	④#4-#14CU, #4-#8AL	AL-175A	UL CSA
*16023	350kcmil-#6CU-AL	④#4-#14CU, #4-#12AL	AL-310A	UL CSA
16220	2/0-#14CU, 2/0-#8AL	④#4-#14CU, #4-#8AL	AL-175A	UL CSA
16321	2/0-#14CU, 2/0-#8AL	④#4-#14CU, #4-#8AL	AL-175A	UL CSA
16323	350kcmil-#6CU-AL	④#4-#14CU, #4-#12AL	AL-310A	UL CSA
16325	②2/0-#14CU, 2/0-#8AL	④#4-#14CU, #4-#8AL	AL-350A	UL CSA
16330	500kcmil-#6CU-AL	④#2-#14CU, #2-#12AL	AL-380A	UL CSA
16332	350kcmil-#6CU-AL	②#2-#14CU, #2-#8AL ②1/0-#14CU, 1/0-#8AL	AL-310A	UL CSA
16335	500kcmil-#6CU-AL	②#2-#14CU, #2-#8AL ②1/0-#14CU, 1/0-#8AL	AL-380A	UL CSA
16370	350kcmil-#6CU-AL	①②#4-#14CU, #4-#12AL	AL-310A	UL CSA
16371	350kcmil-#6CU-AL	④#2-#14CU, #2-#8AL ③1/0-#14CU, 1/0-#8AL	AL-310A	UL CSA
16372	350kcmil-#6CU-AL	②①#10-#14CU, #10AL	AL-310A	UL CSA
16373	350kcmil-#6CU-AL	④1/0-#14CU-AL ①④#10-#14CU, #10AL	AL-310A	UL CSA
16375	600kcmil-#2CU-AL	①②#4-#14CU, #4-#12AL	AL-420A	UL CSA
16376	600kcmil-#2CU-AL	④#2-#14CU, #2-#8AL ③1/0-#14CU, 1/0-#8AL	AL-420A	UL CSA
16377	②300kcmil-#4CU-AL	①②#4-#14CU, #4-#12AL	AL-570A	UL -
16528	②600kcmil-#2CU-AL	④3/0-#6CU-AL ④#4-#14CU-AL	AL-840A	UL CSA
16530	②500kcmil-#6CU-AL	①②#4-#14CU-AL	AL-760A	UL CSA
16541	500kcmil-#6CU-AL	②①#6-#14CU-AL	AL-380A	UL -

*160 Series Bases have mounting holes outside the barriers. Other bases (162 through 165) have mounting holes within barriers. See Data Sheet for dimensional drawings.

How To Order: Catalog Number + # of Poles

Example: 16020 – 3 (complete part number)

Optional covers:
 160 Series: CPB160 - (pole)
 162 Series: CPB162 - (pole)
 163 Series: CPDB- (pole)
 165 Series: CPDB165 (1 for each pole)

CE logo denotes compliance with European Union Low Voltage Directive (50-1000Vac, 75-1500Vdc). Refer to Data Sheet: 8002 or contact Bussmann Application Engineering at 636-527-1270 for more information.

Data Sheet: 1117 (Series 160, 162, 165); 1148 (Series 163)

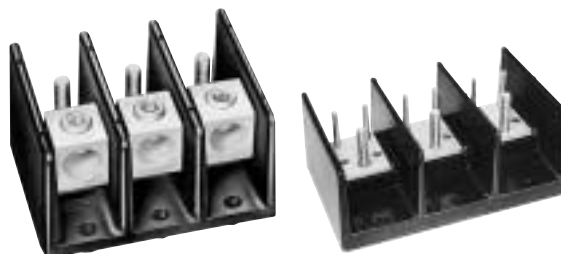

Series 162, 163, 165

Ratings: To 760A, 600V; UL Recognized/CSA. See Table.

Materials: Molded material: Black, UL rated 94V-0 thermoplastic.

Agency Information: UL E62622 General Industrial Class per UL 1059; CSA LR15364.

Connector-Stud Blocks (600V) Catalog Data

Part Number	Line Connection	Load Connection	Connector Material & Ampacity	Agency Information
Connector to Stud				
16280	2/0-#14CU-AL	¼-20 x ¾ Stud	AL-175A	UL CSA
16281	2/0-#14CU-AL	¼-20 Tapped hole	AL-175A	UL CSA
16378	500kcmil-#6CU-AL	②¼-20 x 1 Stud	AL-380A	UL CSA
16383	500kcmil-#6CU-AL	①¾-16 x 1 Stud	AL-380A	UL CSA
16582	②500kcmil-#6CU-AL	②¾-16 x 1½ Stud	AL-760A	UL CSA
Stud to Stud				
16290	¼-20 x ¾ Stud	¼-20 x ¾ Stud	CU-175A	UL -
16390	¾-16 x 1½ Stud	¾-16 x 1½ Stud	CU-250A	UL CSA
16394	½-13 x 1⅞ Stud	½-13 x 1⅞ Stud	CU-400A	UL CSA
16395	¾-16 x 1⅞ Stud	②¼-20 x 9/16 Stud	CU-310A	UL CSA
16591	¾-16 x 1⅞ Stud	②¾-16 x 1⅞ Stud	CU-400A	UL -
16593	½-13 x 1 Stud	½-13 x 1 Stud	CU-600A	UL CSA

Series 160, 162, 163 and 165

Ratings: To 620A, 600V; UL Recognized/CSA. See Table.

Materials: Molded material: Black, UL rated 94V-0 thermoplastic.

Agency Information: UL E62622 General Industrial Class per UL 1059; CSA LR15364.

Power Distribution Blocks (600V) Catalog Data

Part Number	Line Connection	Load Connection	Connector Material & Ampacity	Agency Information
*16000	2/0-#8CU-AL	2/0-#8CU-AL	AL-175A	UL -
*16003	250kcmil-#6CU Only	250kcmil-#6CU Only	CU-255A	UL -
*16005	350kcmil-#6CU-AL	350kcmil-#6CU-AL	AL-310A	UL -
16200	#2-#14CU, #2-#8AL	#2-#14CU, #2-#8AL	AL-115A	UL CSA
16201	1/0-#14CU Only	1/0-#14CU Only	CU-150A	UL CSA
16204	2/0-#8CU-AL	2/0-#8CU-AL	AL-175A	UL CSA
16301	250kcmil-#6CU Only	250kcmil-#6CU Only	CU-255A	UL CSA
16303	350kcmil-#6CU-AL	350kcmil-#6CU-AL	AL-310A	UL CSA
16306	500kcmil-#6CU-AL	500kcmil-#6CU-AL	AL-380A	UL CSA
16500	②350kcmil-#4CU-AL	②350kcmil-#4CU-AL	AL-620A	UL CSA
16504	②500kcmil-#6CU-AL	②500kcmil-#6CU-AL	AL-760A	UL CSA

*160 Series Bases have mounting holes outside the barriers. Other bases (162 through 165) have mounting holes within barriers. See Data Sheet for dimensional drawings.

CE logo denotes compliance with European Union Low Voltage Directive (50-1000Vac, 75-1500Vdc). Refer to Data Sheet: 8002 or contact Bussmann Application Engineering at 636-527-1270 for more information.

Data Sheet: 1117 (Series 160, 162, 165)



Power Distribution Blocks



163 Series

(Replaces Bussmann 164 Series)

Ampere Ratings: up to 420A

Voltage Ratings: 600V

Construction: UL 94V0. Tin-plated aluminum connectors.

Agency Information:

UL Recognized: UL E62622

General Industrial Class per UL1059

CSA Certified: CSA LR15364

Input/Output Termination Options

Basic Part No.	Wire Size		Amps/ Pole	Line/Load
	Line Side	Load Side		
16301*	250kcmil-#6CU Only	250kcmil-#6CU Only	255	
16303	350kcmil-#6CU-AL	350kcmil-#6CU-AL	310	
16306	500kcmil-#6CU-AL	500kcmil-#6CU-AL	380	
16321	2/0-#14CU, 2/0-#8AL	(6)#4-#14CU, #4-#8AL	175	
16323	350kcmil-#6CU-AL	(6)#4-#14CU, #4-#12AL	310	
16325	2/0-#14CU, 2/0-#8AL	(6)#4-#14CU, #4-#8AL	350	
16330	500kcmil-#6CU-AL	(6)#2-#14CU, #2-#12AL	380	
16332	350kcmil-#6CU-AL	(3) #2-#14CU, #2-#8AL (2) 1/0-#14CU, 1/0-#8AL	310	
16335	500kcmil-#6CU-AL	(3) #2-#14CU, #2-#8AL (2) 1/0-#14CU, 1/0-#8AL	380	
16370	350kcmil-#6CU-AL	(12)#4-#14CU, #4-#12AL	310	
16371	350kcmil-#6CU-AL	(6) #2-#14CU, #2-#8AL (3) 1/0-#14CU, 1/0-#8AL	310	
16372	350kcmil-#6CU-AL	(21) #10-#14CU, #10AL	310	
16373	350kcmil-#6CU-AL	(14) #10-#14CU, #10AL (3) 1/0-#14CU-AL	310	
16375	600kcmil-#2CU-AL	(12)#4-#14CU, #4-#12AL	420	
16376	600kcmil-#2CU-AL	(6) #2-#14CU, #2-#8AL (3) 1/0-#14CU, 1/0-#8AL	420	
16377	(2)300kcmil-#4CU-AL	(12)4-#14CU, #4-#12AL	570	
16378	500kcmil-#6CU-AL	Stud Size (2) 1/4-20 x 1	380	
16383	500kcmil-#6CU-AL	Stud Size (1) 3/8-16 x 1	380	
16390	Stud Size 3/8-16 x 1 1/8	Stud Size 3/8-16 x 1 1/8	250	
16394	Stud Size 1/2-13 x 1 1/16	Stud Size 1/2-13 x 1 1/16	400	
16395	Stud Size 3/8-16 x 1 7/16	Stud Size (2) 1/4-20 x 9/16	310	

Optional Covers:

Supplied with (4) #4 thread-cutting screws assembled as shown

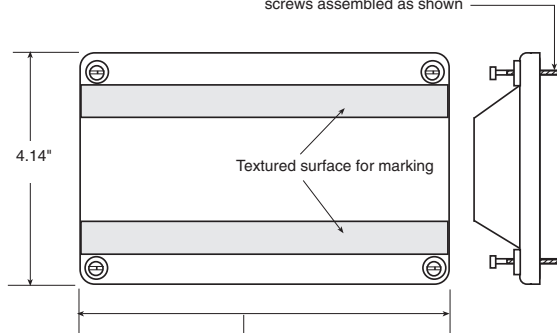

CPDB-1 (single pole) 2.10"
 CPDB-2 (two pole) 3.72"
 CPDB-3 (three pole) 5.34"
 Covers ordered and shipped separately.

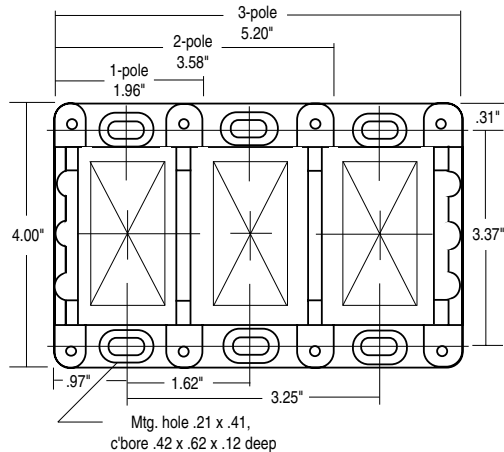

CE logo denotes compliance with European Union Low Voltage Directive (50-1000Vac, 75-1500Vdc). Refer to Data Sheet: 8002 or contact Bussmann Application Engineering at 636-527-1270 for more information.

Ordering Information:

163 Series blocks are available in 1, 2 or 3 poles. To order: **Basic Part No. + Number of poles**

Examples:
 16301-1 = (one-pole block)
 16303-3 = (three-pole block)



Page 98

Blank

(Do NOT Print)

for Fusible Disconnect Switches CFD30CC3 - FD800L3

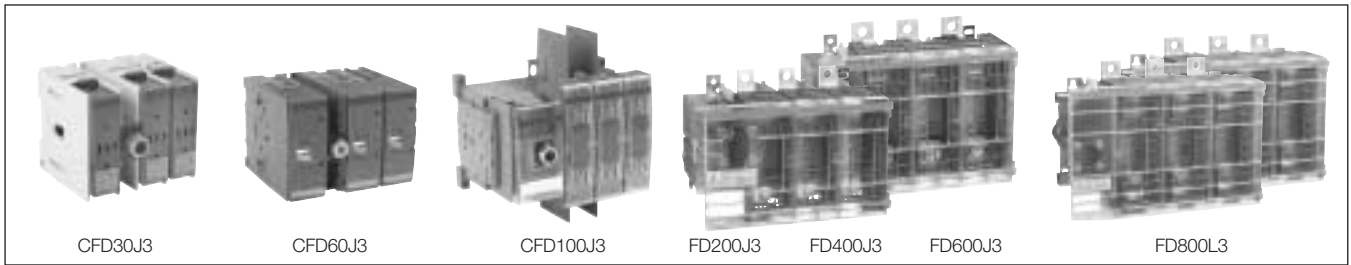

Catalog number	3 pole	CFD30CC3	CFD30J3	CFD60J3	CFD100J3	FD200J3	FD400J3	FD600J3	FD800L3
General purpose amp rating	A	30	30	60	100	200	400	600	800
Approvals^①	2 pole 3 pole 4 pole	N/A UL98 & IEC UL98 & IEC	N/A UL98 & IEC UL98 & IEC	N/A UL98 & IEC UL98 & IEC	UL98 & IEC UL98 & IEC UL98 & IEC	UL98 & IEC UL98 & IEC UL98 & IEC	UL98 & IEC UL98 & IEC UL98 & IEC	UL98 & IEC UL98 & IEC UL98 & IEC	UL98 & IEC UL98 & IEC UL98 & IEC
Technical ratings (UL,CSA)									
Max operating voltage	V	600	600	600	600	600	600	600	600
Max horsepower rating									
Three phase									
200 – 208V	HP	5/7.5	5/7.5	15	25	50	100/125	150	200
240V	HP	7.5	7.5	15	30	60	125	200	250
480V	HP	15	15	30	60	125	250	400	500
600V	HP	20	20	50	75	150	350	500	600
Single phase									
120V	HP	2	2	—	—	—	—	—	—
240V	HP	3	3	—	—	—	—	—	—
UL fuse class		CC	J	J	J	J,T	J,T	J,T	L
Technical ratings (IEC)									
Rated insulation and operational voltage, ac20 and dc20 ^②		1000	1000	750	750	1000	1000	1000	1000
Rated thermal current, I _{th}									
ac 20/dc 20	open	32	32	63	125	250	400	630	800
ac 20/dc 20	enclosed	32	32	63	125	250	400	600	720
ac 21A	≤500V	32	32	63	125	250	400	630	800
ac 21A	≤690V	32	32	63	125	250	400	630	800
Rated operational power ac23									
400/415V	kW	14/15	14/15	30	80/90	132/140	210/230	315/340	350/380
690V	kW	25	25	60	132	230	330	540	600
Physical characteristics									
Weight	3 pole switch	1.54	1.54	2.86	3.30	15.21	17.2	37.48	37.48
	4 pole	1.98	1.98	3.52	3.96	17.4	19.4	46.3	46.3
Dimension	3 pole								
H	in	3.82	3.82	3.94	5.66	7.87	7.87	11.42	11.42
W	in	4.17	4.17	5.63	7.06	10.31	11.22	14.69	14.69
D	in	4.21	4.21	5.04	5.09	7.83	8.11	9.21	9.21
Accessories									
Double break contacts		S	S	S	S	S	S	S	S
Fuse cover		S	S	S	•	S	S	S	S
Terminal lug kit		Integral	Integral	Integral	BDTL24	BDTL25	BDTL26	BDTL27	BDTL27
Terminal shroud		Not required	Not required	Not required	•	•	•	•	•
Auxiliary contact		•	•	•	•	•	•	•	•
Handle UL/NEMA type									
Type 1, 3R, 12		•	•	•	•	•	•	•	•
Type 1, 3R, 4, 4X, 12		•	•	•	•	•	•	•	•
Conversion kit									
6 pole		•	•	•	•	•	•	•	•
Transfer		•	•	•	•	•	•	•	•
Bypass		—	—	—	—	—	—	—	—
Mechanical interlock		•	•	—	—	•	•	•	•
Electrical interlock		—	—	—	—	•	•	•	•

S = Standard

• = Available

— = Not available

① UL listed switches are also CSA approved.

② 1000V IEC 408

UL listed, CSA approved, IEC rated, CE marked



For additional information and detail, see the Bussmann Disconnect Switch Catalog, Item Number 3006

For complete specification data, call Bussmann Information Fax ~ 636.527.1450

Base & DIN Rail Mounted UL Fuse Class J, CC

For a complete assembly, please select one of each:

- 1 switch
- 1 handle
- 1 shaft



CFD30J3



CDS180S



CDH3S



CFD30J3

30A Switches, 600V

UL General Purpose Amp Rating	IEC Fuse Type 600V	Maximum Horsepower Rating					Terminal Lugs		Catalog Number
		Three Phase					Wire Size	Wire Type	
		200V	208V	240V	480V	600V			
3 pole									
30	J	5	7.5	7.5	15	20	#18 - 8	CU	CFD30J3
30	CC	5	7.5	7.5	15	20	#18 - 8	CU	CFD30CC3
4 pole									
30	J	5	7.5	7.5	15	20	#18 - 8	CU	CFD30J4
30	CC	5	7.5	7.5	15	20	#18 - 8	CU	CFD30CC4



CDH3S, 5S



CDH4S, 6S

Selector Handles — For use with shafts □ .20 x .20" (□ 5 x 5 mm)

NEMA Type	IEC Type	Color	Defeatable	Padlockable	Weight (lbs)	Catalog Number
All marked both O/I & Off/On						
1,3R,12	IP65	Black	—	Yes	0.16	CDH3S
1,3R,12	IP65	Red/Yellow	—	Yes	0.16	CDH4S
1,3R,12	IP65	Black	Yes	Yes	0.16	CDH5S
1,3R,12	IP65	Red/Yellow	Yes	Yes	0.16	CDH6S

Shafts — For use with CDH selector handles □ .20 x .20" (□ 5 x 5 mm)

Shaft Length (inches/mm)	 Mounting Depth [Ⓢ] (in inches)	Weight (lbs.)	Catalog Number
3.3/85	5.5 - 5.7	0.04	CDS85S
4.1/105	5.5 - 6.5	0.04	CDS105S
4.7/120	5.5 - 7.1	0.05	CDS120S
5.1/130	5.5 - 7.5	0.05	CDS130S
7.1/180	6.3 - 9.4	0.08	CDS180S
9.8/250	9.1 - 12.2	0.10	CDS250S
13.0/330	12.2 - 15.4	0.14	CDS330S



CDS__S

For additional information and detail see the Bussmann Disconnect Switch Catalog item number 3006



For 30A Fusible Disconnect Switches

For a complete assembly, please select one of each:

- 1 switch
- 1 handle
- 1 shaft



CFD30J3

+

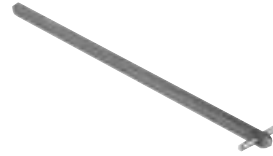

CDS67P

+



BDH106

Pistol Handles

For use with shafts □ .20 x .20" (□ 5 x 5 mm)



BDH104, 106



BDH105, 107

NEMA Type	IEC Type	Color	Marking	Length (inches/mm)	Defeatable	Padlockable	Weight (lbs.)	Catalog Number
1,3R,12	IP65	Black	O/I&Off/On	1.8/45	Yes	Yes	0.28	BDH104
1,3R,12	IP65	Red/Yellow	O/I&Off/On	1.8/45	Yes	Yes	0.28	BDH105
1,3R,12	IP65	Black	O/I&Off/On	2.6/65	Yes	Yes	0.29	BDH106
1,3R,12	IP65	Red/Yellow	O/I&Off/On	2.6/65	Yes	Yes	0.29	BDH107
1,3R,4,4X,12	IP65	Black	O/I&Off/On	2.6/65	Yes	Yes	0.29	CDHXB65
1,3R,4,4X,12	IP65	Red/Yellow	O/I&Off/On	2.6/65	Yes	Yes	0.29	CDHXY65
1,3R,12	IP65	Black	Off/On/Test	2.6/65	Yes	Yes	0.29	BDH106T
1,3R,12	IP65	Red/Yellow	Off/On/Test	2.6/65	Yes	Yes	0.29	BDH107T

Shafts

For use with pistol handles □ .20 x .20" (□ 5 x 5 mm)



CDS__P

Shaft length (inches/mm)	Mounting Depth (in inches)	Weight (lbs.)	Catalog Number
5.9/150	4.9 - 8.9	0.07	CDS48P
6.7/170	5.9 - 9.7	0.08	CDS67P
10.4/265	9.5 - 13.4	0.12	CDS49P
15.8/400	15.0 - 18.7	0.18	CDS50P
19.7/500	20.5 - 22.6	0.23	CDS99P

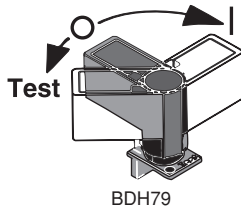

BDH79

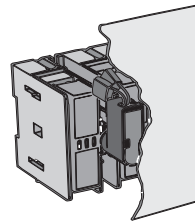

BDH79 Mounted

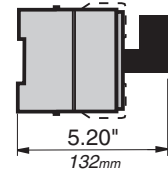

5.20"/132mm
BDH79 Mounted Depth

Direct Mount Handle

Mounts directly to switch, no shaft necessary

NEMA Type	Color	Marking	Length (Inches/mm)	Padlockable	Weight (lbs.)	Catalog Number
1	Black	O/I/Test	50	Yes	0.10	BDH79



For additional information and detail see the Bussmann Disconnect Switch Catalog item number 3006

For complete specification data, call Bussmann Information Fax ~ 636.527.1450

For Fusible Disconnect Switches UL Fuse Class J

For a complete assembly, please select one of each:

- 1 switch
- 1 handle
- 1 shaft
- 1 terminal lug kit



CFD60J3



BDS210



BDH58

60 – 100A Switches, 600V

UL General Purpose Amp Rating	UL Fuse Type 600V	Maximum Horsepower Rating					Catalog Number
		Three Phase					
		200V	208V	240V	480V	600V	
3 pole							
60	J	15	15	15	30	50	3 pole CFD60J3
100	J	25	25	30	60	75	CFD100J3
4 pole							
60	J	15	15	15	30	50	4 pole CFD60J4
100	J	25	25	30	60	75	CFD100J4



CFD60J3

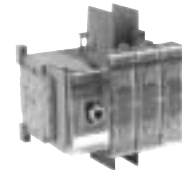

CFD100J3

Pistol Handles — □ .24 x .24" (□ 6 x 6 mm)

BDH58, 60



BDH59, 61



NEMA/UL Type	IEC Type	Color	Length (inches/mm)	Marking	Defeatable	Padlockable	Weight (lbs.)	Catalog Number
1,3R,12	IP65	Black	2.6/65	O/I & Off/On	Yes	Yes	0.29	BDH58
1,3R,12	IP65	Red/Yel	2.6/65	O/I & Off/On	Yes	Yes	0.29	BDH59
1,3R,12	IP65	Black	3.1/80	O/I & Off/On	Yes	Yes	0.30	BDH60
1,3R,12	IP65	Red/Yel	3.1/80	O/I & Off/On	Yes	Yes	0.30	BDH61
1,3R,4,4X,12	IP65	Black	3.1/80	O/I & Off/On	Yes	Yes	0.30	CDHXB86
1,3R,4,4X,12	IP65	Red/Yel	3.1/80	O/I & Off/On	Yes	Yes	0.30	CDHXY86

Shafts — □ .24 x .24" (□ 6 x 6 mm)



BDS__

Shaft Length (inches/mm)	Mounting Depth (inches)	Weight (lbs.)	Catalog Number
5.9/150	5.5 – 8.5	0.09	BDS150
8.3/210	8.0 – 11.0	0.13	BDS210
11.4/290	11.0 – 14.0	0.18	BDS290
14.2/360	13.8 – 16.8	0.23	BDS360
16.9/430	16.5 – 19.7	0.27	BDS430

Twisted Shafts

Rotates handle 45° □ .24 x .24" (□ 6 x 6 mm)

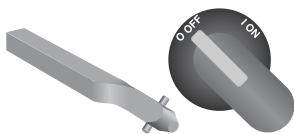

BDST__

Shaft Length (inches/mm)	Mounting Depth (inches)	Weight (lbs.)	Catalog Number
5.1/130	4.8 – 7.8	0.08	BDST4
8.3/210	8.0 – 11.0	0.13	BDST25
11.4/290	11.0 – 14.0	0.18	BDST29
14.2/360	13.8 – 16.8	0.23	BDST30

Direct Mount Handle

Mounts directly to switch, no shaft necessary

NEMA Type	Color	Marking	Length (Inches/mm)	Padlockable	Weight (lbs.)	Catalog Number
1	Black	O/I/Test	50	Yes	0.10	CDH4

For additional information and detail see the Bussmann Disconnect Switch Catalog item number 3006



For 60A - 100A Fusible Disconnect Switches



BDTL24

Terminal Lug Kit

For Use On:	Wire Size	Kit Weight (lbs.)	Wire Type	Terminal Lugs Per Kit	Catalog Number
CFD60J_	#14 - 4	—	CU	—	Integral
CFD100J_	#14 - 2/0	0.43	CU/AL	6	BDTL24

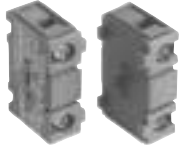

CDAUX10 CDAUX01K

Auxiliary Contacts

Description	For Use On:	Weight (lbs.)	AC Thermal Amp Rating	AC Rated Voltage	Catalog Number
1 N.O.	CFD60 - CFD100	0.07	10	600	CDAUX10
1 N.C.		0.07	10	600	CDAUX01K



CFC60J



CFCVR100

Replacement Fuse Clip

Description	For Use On:	Catalog Number
Removable fuse carrier	CFD60	CFC60J

Replacement Fuse Covers

Description	For Use On:	Catalog Number
Transparent fuse cover	CFD100	CFCVR100



CFTS100

Terminal Shroud

Description	For Use On:	Weight (lbs.)	Catalog Number
Includes one terminal shroud for line or load side	CFD100, 1-POLE	0.04	CFTS100



CFZ1

Terminal Poles

Description	For Use On:	Weight (lbs.)	AC Thermal Amp Rating	AC Rated Voltage	Catalog Number
Detachable neutral mounts on side of switch or DIN rail	CFD60	0.13	63	600	CFZ1
	CFD100	0.31	125	600	CFZ2

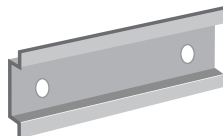

NDNA100

DIN Rail

Description	For Use On:	Weight (lbs.)	Length (inches/mm)	Catalog Number
35mm Aluminum DIN Rail	CFD60	.38	39.4/1000	NDNA100
35mm Aluminum DIN Rail	CFD60	.75	78.8/1000	NDNA200

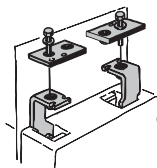

BDTA1

"T" Type Fuse Adapter Kit

Description	For Use On:	Catalog Number
100A, 600V	CFD100	BDTA1



For additional information and detail see the Bussmann Disconnect Switch Catalog item number 3006

For complete specification data, call Bussmann Information Fax ~ 636.527.1450

Fusible Disconnect Switches UL Fuse Class J, T, L

For a complete assembly, please select one of each:

- 1 switch
- 1 handle
- 1 shaft
- 1 terminal lug kit

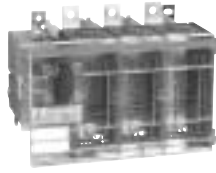

FD200J3



BDS280



BDH114

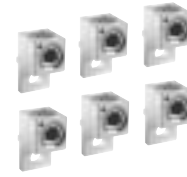

BDTL25

200 — 800A Switches, 600V

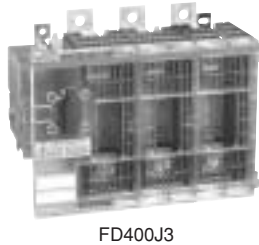

FD400J3

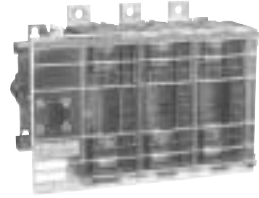

FD600J3
FD800L3

UL General Purpose Amp Rating	UL Fuse Type 600V	Maximum Horsepower Rating Three Phase					Catalog Number
		200V	208V	240V	480V	600V	
2 pole							2 pole
200	JⓂ	—	—	—	—	—	FD200J2
400	JⓂ	—	—	—	—	—	FD400J2
600	JⓂ	—	—	—	—	—	FD600J2
800	L	—	—	—	—	—	FD800L2
3 pole							3 pole
200	JⓂ	50	50	60	125	150	FD200J3
400	JⓂ	100	125	125	250	350	FD400J3
600	JⓂ	150	150	200	400	500	FD600J3
800	L	200	200	250	500	600	FD800L3
4 pole							4 pole
200	JⓂ	50	50	60	125	150	FD200J4
400	JⓂ	100	125	125	250	350	FD400J4
600	JⓂ	150	150	200	400	500	FD600J4
800	L	200	200	250	500	600	FD800L4



BDH112



BDH113

Pistol Handles — □ .47 x .47" (□ 12 x 12 mm)

NEMA Type	IEC Type	Color	Length (inches/mm)	Marking	Defeatable	Padlockable	Weight (lbs.)	Catalog Number
1,3R,12	IP65	Black	4.9/125	O/I & Off/On	Yes	Yes	0.39	BDH112
1,3R,12	IP65	Red/Yellow	4.9/125	O/I & Off/On	Yes	Yes	0.39	BDH113
1,3R,12	IP65	Black	5.7/145	O/I & Off/On	Yes	Yes	0.39	BDH114
1,3R,12	IP65	Red/Yellow	5.7/145	O/I & Off/On	Yes	Yes	0.39	BDH115
1,3R,12	IP65	Black	6.9/175	O/I & Off/On	Yes	Yes	0.41	BDH116
1,3R,12	IP65	Red/Yellow	6.9/175	O/I & Off/On	Yes	Yes	0.41	BDH117
1,3R,4,4X,12	IP65	Black	5.7/145	O/I & Off/On	Yes	Yes	0.39	CDHXB12
1,3R,4,4X,12	IP65	Red/Yellow	5.7/145	O/I & Off/On	Yes	Yes	0.39	CDHXY12
1,3R,4,4X,12	IP65	Black	6.9/175	O/I & Off/On	Yes	Yes	0.41	CDHXB22
1,3R,4,4X,12	IP65	Red/Yellow	6.9/175	O/I & Off/On	Yes	Yes	0.41	CDHXY22
1,3R,4,4X,12	IP65	Metal	8.7/220	Off/On	—	Yes	1.50	BDH8

Ⓜ J type fuse clips are standard. If 600V Type "T" clips are desired, please order a "T" type fuse adapter kit.

For additional information and detail see the Bussmann Disconnect Switch Catalog item number 3006



For 200A - 800A Fusible Disconnect Switches

Shafts — □ .47 x .47" (□ 12 x 12 mm)

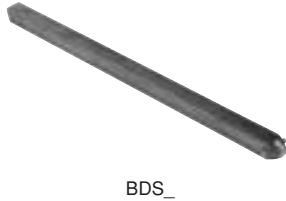

BDS_

Shaft Length (inches/mm)	 Mounting Depth [Ⓞ] (in inches)	Weight (lbs.)	Catalog Number
For use on FD200J_ – FD400J_			
8.7/220	7.9 – 12.2	0.61	BDS220
9.8/250	9.1 – 13.4	0.70	BDS250
11.0/280	10.2 – 14.5	0.77	BDS280
12.8/325	12.0 – 16.3	0.90	BDS325
15.6/395	14.8 – 19.1	1.10	BDS395
18.3/465	17.5 – 21.9	1.32	BDS465
21.1/535	20.3 – 24.6	1.54	BDS535
For use on FD600J_ – FD800J_			
9.8/250	10.0 – 12.8	0.70	BDS250
11.0/280	11.2 – 14.0	0.77	BDS280
12.8/325	13.0 – 15.8	0.90	BDS325
15.6/395	15.8 – 18.6	1.10	BDS395
18.3/465	18.5 – 21.3	1.32	BDS465
21.1/535	21.1 – 24.1	1.54	BDS535

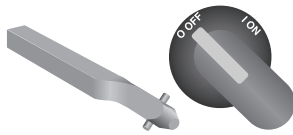

BDS_45

Twisted Shafts

Rotates handle 45° □ .47 x .47" (□ 12 x 12 mm)

Shaft Length (inches/mm)	 Mounting Depth (in inches)	Weight (lbs.)	Catalog Number
For use on FD200J_ – FD400J_			
11.0/280	10.2 – 14.5	0.77	BDS28045
12.8/325	12.0 – 16.3	0.90	BDS32545
18.3/465	17.5 – 21.9	1.32	BDS46545
For use on FD600J_ – FD800J_			
11.0/280	11.2 – 14.0	0.77	BDS28045
12.8/325	13.0 – 15.8	0.90	BDS32545
18.3/465	18.5 – 21.3	1.32	BDS46545



BDTL25



BDTL27



BDTL175



BDTL26



BDTL175/400

Terminal Lug Kit

For Use On:	Wire Size	Kit Weight (lbs.)	Wire Type	Terminal Lugs Per Kit	Catalog Number
FD200J_	#6 – 300 kcmil	0.93	Cu/Al	6	BDTL25
FD200J	(6) #14 – 6 kcmil	0.93	Cu/Al	3	BDTL175
FD400J_	#2 – 600 kcmil	3.50	Cu/Al	6	BDTL26
FD600J – FD800L	(12) #14 – 16–600 kcmil	1.10	Cu/Al	3	BDTL175/400
FD600J_ & FD800L_	(2) #2 – 600 kcmil	4.62	Cu/Al	6	BDTL27



BDA

“T” Type Fuse Adapter Kit

For Use On:	AC Thermal Amp Rating	AC Rated Voltage	Poles	Catalog Number
FD200J_	200	600	3	BDA2
FD400J_	400	600	3	BDA4
FD600J_	600	600	3	BDA6

Ⓞ Mounting depth is the distance from the outside of the door to the disconnect switch mounting plate. Shaft can be cut to desired length.



For additional information and detail see the Bussmann Disconnect Switch Catalog item number 3006

For complete specification data, call Bussmann Information Fax ~ 636.527.1450

For Non-Fusible Disconnect Switches CDNF16 - CDNF160

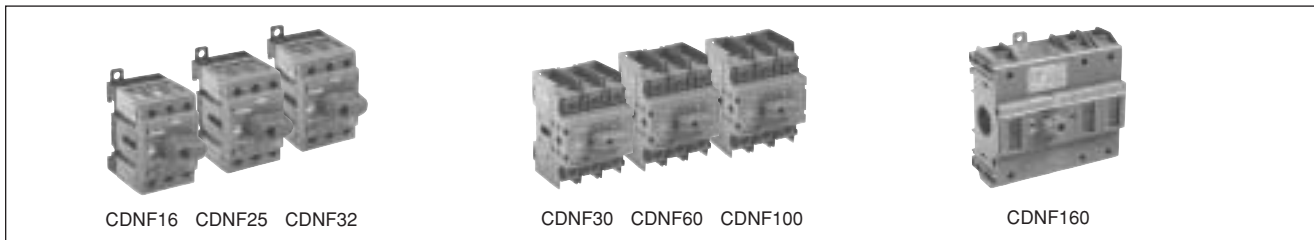

Catalog Number	3 pole	CDNF16	CDNF25	CDNF32	CDNF45	CDNF63	CDNF30	CDNF60	CDNF100	CDNF160
General Purpose Amp Rating	A	16	25	40	60	80	30	60	100	125
Approvals ^①	2 pole 3 pole 4 pole	N/A UL508 UL508	N/A UL508 UL508	N/A UL508 UL508	N/A UL508 UL508	N/A UL508 UL508	N/A UL98 UL98	N/A UL98 UL98	N/A UL98 UL98	UL98 UL98 UL98
Technical Ratings										
UL, CSA										
Max operating voltage	V	600	600	600	600	600	600	600	600	600
Max horsepower rating										
Three phase										
200 – 208V	HP	3	7.5	10	15	20	10	20	25	30
240V	HP	5	7.5	10	15	20	10	20	30	30
480V	HP	10	15	20	30	40	20	40	50	75
600V	HP	10	20	25	30	40	30	40	50	100
Single phase										
120V	HP	1/2	3/4	1	2	2	2	3	5	7.5
240V	HP	1.5	2	3	5	5	5	7.5	15	20
Technical Ratings										
IEC										
Rated insulation and operational voltage.										
ac20 and dc20	V	750	750	750	750	750	750	750	750	750
Rated thermal current, Ith										
ac 20/dc 20 open	A	25	32	40	63	80	40	63	115	200
ac 20/dc 20 enclosed	A	25	32	40	63	80	40	63	115	160
ac 21A 500V	A	16	25	32	63	80	40	63	100	160
ac 21A 690V	A	16	25	32	63	80	40	63	100	160
Rated operational power ac23										
400/415V kW		7.5	9	11	22	37	15	18.5	37	75
690V kW		7.5	9	11	15	18.5	15	15	37	75
Physical Characteristics										
Weight	3 pole lb	0.24	0.24	0.24	0.59	0.59	0.79	0.79	0.79	2.42
Dimension	3 pole] H in	2.68	2.68	2.68	3.60	3.60	3.94	3.94	3.94	5.00
	W in	1.38	1.38	1.38	2.07	2.07	2.76	2.76	2.76	4.96
	D in	2.20	2.20	2.20	2.85	2.85	2.95	2.95	2.95	2.93
Accessories										
Terminal lug kit		Integral	Integral	Integral	Integral	Integral	Integral	Integral	Integral	Integral
Terminal shroud		•	•	•	•	•	•	•	•	•
Auxiliary contact		•	•	•	•	•	•	•	•	•
Handle UL/NEMA type										
Type 1, 3R, 12		•	•	•	•	•	•	•	•	•
Type 1, 3R, 4, 4X, 12		•	•	•	•	•	•	•	•	•
Handle type										
Selector		•	•	•	•	•	—	—	—	—
Pistol		•	•	•	•	•	•	•	•	•
Conversion kits										
6 pole		•	•	•	•	•	•	•	•	•
Transfer		•	•	•	•	•	•	•	•	•
Bypass		•	•	•	•	•	•	•	•	•
Mechanical interlock		•	•	•	•	•	•	•	—	•
Electrical interlock		—	—	—	—	—	—	—	—	—

• = Available

— = Not available

① UL listed switches are also CSA approved.

UL listed, CSA approved, IEC rated, CE marked

For additional information and detail see the Bussmann Disconnect Switch Catalog item number 3006



For Non-Fusible Disconnect Switches BDNF200A - BDNF3150

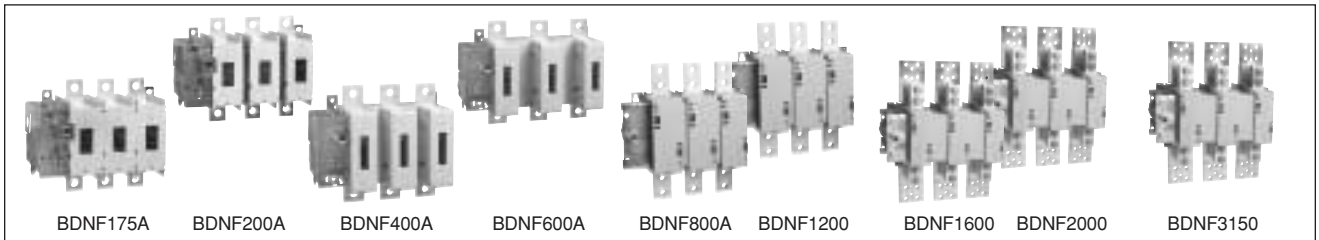

Catalog Number	3 pole	BDNF175A	BDNF200A	BDNF400A	BDNF600A	BDNF800A	BDNF1200	BDNF1600	BDNF2000	BDNF3150
General Purpose Amp Rating	A	175	200	400	600	800	1200	1600	2000	3150
Approvals ^①	2 pole 3 pole 4 pole	UL508 & IEC UL508 & IEC IEC	UL98 & IEC UL98 & IEC IEC	UL98 & IEC UL98 & IEC UL98 & IEC	UL98 & IEC UL98 & IEC UL98 & IEC	UL98 & IEC UL98 & IEC UL98 & IEC	UL98 & IEC UL98 & IEC IEC	UL98 & IEC UL98 & IEC IEC	UL98 & IEC UL98 & IEC IEC	IEC IEC IEC
Technical Ratings										
UL, CSA										
Max operating voltage	V	600	600	600	600	600	600	600	600	600
Max horsepower rating										
Three phase										
200 – 208V	HP	30	60	100	150	200	—	—	—	—
240V	HP	40	75	125	200	250	—	—	—	—
480V	HP	75	150	250	400	500	—	—	—	—
600V	HP	100	200	350	500	600	—	—	—	—
Single phase										
120V	HP	—	—	—	—	—	—	—	—	—
240V	HP	—	—	—	—	—	—	—	—	—
Technical Ratings										
IEC										
Rated insulation and operational voltage.										
ac20 and dc20	V	1000	1000	1000	1000	1000	1000	1000	1000	1000
Rated thermal current, I _{th}										
ac 20/dc 20 open	A	200	315	630	800	1250	1600	2500	2500	3150
ac 20/dc 20 enclosed	A	200	270	630	720	1250	1600	2300	2300	2600
ac 21A 500V	A	200	250	630	800	1250	1600	2500	2500	3150
ac 21A 690V	A	200	250	630	800	1250	1600	2500	2500	3150
Rated operational power ac23										
400/415V kW		90	132	315	355	400	400	400	400	400
690V kW		170	200	355	355	—	—	—	—	—
Physical Characteristics										
Weight	3 pole lb	6.61	6.61	13.66	13.66	35.9	38.55	127.7	127.7	127.7
Dimension	3 pole H in	8.35	8.35	11.81	11.77	19.09	19.09	25.04	25.04	25.04
	W in	7.83	8.62	10.24	11.93	14.29	14.29	18.43	18.43	18.43
	D in	4.55	4.55	5.12	5.12	4.92	4.92	10.67	10.67	10.67
Accessories										
Terminal lug kit		BDTL25	BDTL25	BDTL26	BDTL27	BDTL30	BDTL28	BDTL28	BDTL28/2	BDTL28/2
Terminal shroud		•	•	•	•	•	•	—	—	—
Auxiliary contact		•	•	•	•	•	•	•	•	•
Handle UL/NEMA type										
Type 1, 3R, 12		•	•	•	•	•	•	•	•	•
Type 1, 3R, 4, 4X, 12		•	•	•	•	•	•	•	•	•
Handle type										
Selector		—	—	—	—	—	—	—	—	—
Pistol		•	•	•	•	•	•	•	•	•
Conversion kits										
6 pole		•	•	•	•	•	•	—	—	—
Transfer		•	•	•	•	•	•	—	—	—
Bypass		•	•	•	•	•	•	—	—	—
Mechanical interlock		•	•	•	•	•	•	•	•	•
Electrical interlock		•	•	•	•	•	•	•	•	•

S = Standard feature

• = Available

— = Not available

① UL listed switches are also CSA approved.

UL listed, CSA approved, IEC rated, CE marked



For additional information and detail see the Bussmann Disconnect Switch Catalog item number 3006

For complete specification data, call Bussmann Information Fax ~ 636.527.1450

For Non-Fusible Disconnect Switches Base & DIN Rail Mounted

For a complete assembly, please select one of each:

- 1 switch
- 1 handle
- 1 shaft



CDNF63



CDS85S



CDH3S



CDNF16
CDNF25
CDNF32



CDNF30
CDNF60
CDNF100



CDH1S



CDH15S



CDH6S

16 — 100 Amp Switches, 600V, 3 Pole^①

UL General Purpose Amp Rating	IEC AC21 Amp Rating	Maximum Horsepower Rating					Terminal Lugs		Catalog Number
		Single Phase		Three Phase			Wire Size	Wire Type	
		120V	240V	240V	480V	600V			
16	16	1/2	1.5	5	10	10	#18 - 8	CU	CDNF16
25	25	3/4	2	7.5	15	20	#18 - 8	CU	CDNF25
40	40	1	3	10	20	25	#18 - 8	CU	CDNF32
60	63	2	5	15	30	30	#14 - 4	CU	CDNF45
80	80	2	5	20	40	40	#14 - 1	CU	CDNF63
30	40	2	5	10	20	30	#14 - 4	CU	CDNF30
60	63	3	7.5	20	40	40	#14 - 4	CU	CDNF60
100	115	5	15	30	50	50	#8 - 1/0	CU	CDNF100

Selector Handles — For use with shafts □ .20 x .20" (□ 5 x 5 mm)

NEMA Type	IEC Type	Color	Defeatable	Padlockable	Weight (lbs)	Catalog Number
All marked both O/I & Off/On						
1	IP54	Black	—	—	0.09	CDH1S ^②
1	IP54	Red/Yellow	—	—	0.09	CDH2S ^②
1	IP54	Black	—	Yes	0.12	CDH15S ^②
1	IP54	Red/Yellow	—	Yes	0.12	CDH16S ^②
1,3R,12	IP65	Black	—	Yes	0.16	CDH3S
1,3R,12	IP65	Red/Yellow	—	Yes	0.16	CDH4S
1,3R,12	IP65	Black	Yes	Yes	0.16	CDH5S
1,3R,12	IP65	Red/Yellow	Yes	Yes	0.16	CDH6S

Shafts — For use with CDH selector handles □ .20 x .20" (□ 5 x 5 mm)

Shaft Length (inches /mm)	Mounting depth ^③ in inches					Weight (lbs.)	Catalog Number
	CDNF16 CDNF25 CDNF32		CDNF45 CDNF63		CDNF30 CDNF60 CDNF100		
	CDH1S CDH2S CDH15S CDH16S	CDH3S CDH4S CDH5S CDH6S	CDH1S CDH2S CDH15S CDH16S	CDH3S CDH4S CDH5S CDH6S	CDH3S CDH4S CDH5S CDH6S		
3.3/85	4.2 - 5.0	3.6 - 4.3	4.9 - 5.6	4.4 - 5.0	3.9 - 4.9	0.04	CDS85S
4.1/105	5.0 - 5.8	4.4 - 5.1	5.7 - 6.4	5.1 - 5.8	4.7 - 5.7	0.04	CDS105S
4.7/120	5.6 - 6.4	5.0 - 5.8	6.3 - 7.0	5.7 - 6.4	5.3 - 6.3	0.05	CDS120S
5.1/130	6.0 - 6.7	5.4 - 6.1	6.7 - 7.4	6.1 - 6.8	5.6 - 6.7	0.05	CDS130S
7.1/180	7.1 - 8.7	7.4 - 8.1	8.6 - 9.4	8.1 - 8.7	7.6 - 8.6	0.08	CDS180S
9.8/250	10.7 - 11.5	10.1 - 10.8	11.4 - 12.1	10.9 - 11.5	10.4 - 11.4	0.10	CDS250S
13/330	13.8 - 14.6	13.3 - 14.0	14.6 - 15.3	14.0 - 14.7	13.5 - 14.5	0.14	CDS330S

① A snap on fourth pole may be added

② Not suitable for use with CDNF30, 60, 100.

③ Mounting depth is the distance from the outside of door to the disconnect switch mounting plate. Shaft can be cut to desired length.

For additional information and detail see the Bussmann Disconnect Switch Catalog item number 3006



For 16A-100A Non-Fusible Disconnect Switches

Base & DIN Rail Mounted



BDH104, 106



BDH107

Pistol Handles — For use with shafts □ .20 x .20" (□ 5 x 5 mm)

NEMA Type	IEC Type	Color	Marking	Length (inches/mm)	Defeatable	Padlockable	Weight (lbs.)	Catalog Number
1,3R,12	IP65	Black	O/I & Off/On	1.8/45	Yes	Yes	0.28	BDH104
1,3R,12	IP65	Red/Yel	O/I & Off/On	1.8/45	Yes	Yes	0.28	BDH105
1,3R,12	IP65	Black	O/I & Off/On	2.6/65	Yes	Yes	0.29	BDH106
1,3R,12	IP65	Red/Yel	O/I & Off/On	2.6/65	Yes	Yes	0.29	BDH107
1,3R,12,4,4X	IP66	Black	O/I & Off/On	2.6/65	Yes	Yes	0.29	CDHXB65
1,3R,12,4,4X	IP66	Red/Yel	O/I & Off/On	2.6/65	Yes	Yes	0.29	CDHXY65

Shafts — For use with pistol handles □ .20 x .20" (□ 5 x 5 mm)

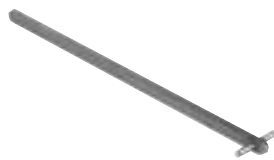

CDS_P

Shaft Length (inches/mm)	Mounting depth ^① in inches			Weight (lbs.)	Catalog Number
	CDNF16 CDNF25 CDNF32	CDNF45 CDNF63	CDNF30 CDNF60 CDNF100		
5.9/150	6.2 – 6.7	6.9 – 7.4	6.4 – 7.4	0.07	CDS48P
6.7/170	7.0 – 7.5	7.7 – 8.1	7.2 – 8.1	0.08	CDS67P
10.4/265	10.7 – 11.3	11.4 – 11.9	10.9 – 11.9	0.12	CDS49P
15.8/400	16.0 – 16.6	16.8 – 17.2	16.2 – 17.2	0.18	CDS50P
19.7/500	20.0 – 20.5	20.7 – 21.1	20.1 – 21.1	0.23	CDS99P

Twisted Shafts

Rotates handle 45° □ .20 x .20" (□ 5 x 5 mm)

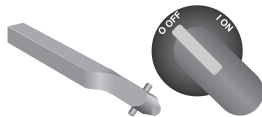

CDS_T

Shaft Length (inches/mm)	Mounting depth ^① in inches			Weight (lbs.)	Catalog Number
	CDNF16 CDNF25 CDNF32	CDNF45 CDNF63	CDNF30 CDNF60 CDNF100		
5.9/150	6.2 – 6.7	6.9 – 7.4	6.4 – 7.4	0.07	CDS48T
6.7/170	7.0 – 7.5	7.7 – 8.1	7.2 – 8.1	0.08	CDS67T
10.4/265	10.7 – 11.3	11.4 – 11.9	10.9 – 11.9	0.12	CDS49T
15.8/400	16.0 – 16.6	16.8 – 17.2	16.2 – 17.2	0.18	CDS50T



CDBY68419/1



CDMC1

Replacement Knob

Mounts directly to switch; no shaft necessary



OPMRH



CDBY68306

NEMA Type	Color	For Use On:	Length (inches)	Padlockable	Catalog Number
1	Red	CDNF16, 25, 32	1.0	—	OPMRH
1	Red	CDNF30, 45, 60, 63, 100	1.4	—	CDBY68306 ^③
1	Red	CDNF30, 45, 60, 63, 100	1.6	Yes ^②	CDBY68419/1 ^③
Metal collar		CDNF16 – CDNF100	—	—	CDMC1
Set screw		CDNF16, 25, 30, 32, 45, 60, 63, 100	—	—	CDSWM5X8

① Mounting depth is the distance from the outside of door to the disconnect switch mounting plate. Shaft can be cut to desired length.

② .1875" (3/16") diameter shackle required.

③ Set screw CDSWM5X8 needed with replacement knobs CDBY__.



For additional information and detail see the Bussmann Disconnect Switch Catalog item number 3006

For complete specification data, call Bussmann Information Fax ~ 636.527.1450

Non-Fusible Disconnect Switches Door Mounted

For a complete assembly, please select one of each:

- 1 switch
- 1 handle



CDNF45D



CDH9S



CDNF16D
CDNF25D
CDNF32D

16 — 100 Amp Switches, 600V, 3 Pole^{①②③}

UL General Purpose Amp Rating	IEC AC21 Amp Rating	Maximum Horsepower Rating					Terminal Lugs		Catalog Number
		Single Phase		Three Phase			Wire Size	Wire Type	
		120V	240V	240V	480V	600V			
16	16	1/2	1.5	5	10	10	#18 - 8	CU	CDNF16D
25	25	3/4	2	7.5	15	20	#18 - 8	CU	CDNF25D
40	40	1	3	10	20	25	#18 - 8	CU	CDNF32D
60 ^④	63	2	5	15	30	30	#14 - 4	CU	CDNF45D
80 ^④	80	2	5	20	40	40	#14 - 1	CU	CDNF63D
30 ^④	40	2	5	10	20	30	#14 - 4	CU	CDNF30D
60 ^④	63	3	7.5	20	40	40	#14 - 4	CU	CDNF60D
100 ^④	115	5	15	30	50	50	#8 - 1/0	CU	CDNF100D



CDH8S
CDH12S

Selector Handles

NEMA/UL Type	IEC Type	Color	Defeatable	Padlockable	Weight (lbs)	Catalog Number
All marked both O/I & Off/On						
Snap-on mounting — for use on CDNF16, 25, 32D						
1	IP54	Black	—	—	0.10	CDH7S
1	IP54	Red/Yellow	—	—	0.10	CDH8S
1	IP54	Black	—	Yes	0.13	CDH19S
1	IP54	Red/Yellow	—	Yes	0.13	CDH20S
1,3R,12	IP65	Black	—	Yes	0.17	CDH9S
1,3R,12	IP65	Red/Yellow	—	Yes	0.17	CDH10S
Screw mounting — for use on CDNF16, 32, 45 & 63D						
1	IP54	Black	—	—	0.11	CDH11S
1	IP54	Red/Yellow	—	—	0.11	CDH12S
1	IP54	Black	—	Yes	0.14	CDH17S
1	IP54	Red/Yellow	—	Yes	0.14	CDH18S
1,3R,12	IP65	Black	—	Yes	0.18	CDH13S
1,3R,12	IP65	Red/Yellow	—	Yes	0.18	CDH14S



CDH17S
CDH19S



CDH9S
CDH13S



CDH10S
CDH14S

Door mounted switches do not provide door interlock

Pistol Grip Handle Adapter

Description	For Use On:	Weight (lbs)	Catalog Number
Adapter piece for pistol grip handle	CDNF30, CDNF60, CDNF100	0.18	CDHZX6

- ① A snap on fourth pole may be added
- ② Door mounted switches do not require shafts.
- ③ CDNF16, 25, 32, 45 & 63 door mounted switches will not accept pistol handles.
- ④ CDNF45 & 63 door mounted switches can only use screw mounted handles.

For additional information and detail see the Bussmann Disconnect Switch Catalog item number 3006



Non-Fusible Disconnect Switches

For a complete assembly, please select one of each:

- 1 switch
- 1 handle
- 1 shaft
- 1 terminal lug kit

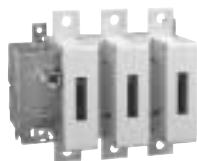

BDNF400



BDS280



BDH116



BDTL26

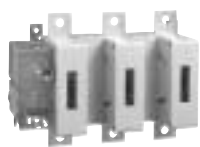

BDNF600A

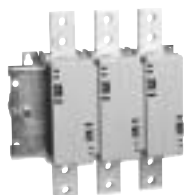

BDNF800A



BDH112-117



BDS280

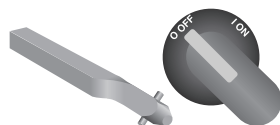

BDS_45

400 – 800 Amp switches, 600V

UL general purpose amp rating	IEC AC21 amp rating	Maximum horsepower rating					Catalog number
		200V	208V	240V	480V	600V	
2 pole							
400	630	—	—	—	—	—	BDNF4002
600	800	—	—	—	—	—	BDNF600A2
800	1250	—	—	—	—	—	BDNF800A2
3 pole							
400	630	100	100	125	250	350	BDNF400
600	800	150	150	200	400	500	BDNF600A
800	1250	200	200	250	500	600	BDNF800A
4 pole							
400	630	100	100	125	250	350	BDNF4004
600	800	150	150	200	400	500	BDNF600A4
—	1250	200	200	250	500	600	BDNF800A4

Pistol handles — for use with shafts □ .47 x .47" (□ 12 x 12 mm)

NEMA type	IEC type	Color	Length in/mm	Marking	Defeatable	Padlockable	Weight (lbs)	Catalog number
1,3R,12	IP65	Blk	4.9/125	O/I & Off/On	Yes	Yes	0.39	BDH112
1,3R,12	IP65	R/Y	4.9/125	O/I & Off/On	Yes	Yes	0.39	BDH113
1,3R,12	IP65	Blk	5.7/145	O/I & Off/On	Yes	Yes	0.39	BDH114
1,3R,12	IP65	R/Y	5.7/145	O/I & Off/On	Yes	Yes	0.39	BDH115
1,3R,12	IP65	Blk	6.9/175	O/I & Off/On	Yes	Yes	0.41	BDH116
1,3R,12	IP65	R/Y	6.9/175	O/I & Off/On	Yes	Yes	0.41	BDH117
1,3R,4,4X,12	IP66	Blk	5.7/145	O/I & Off/On	Yes	Yes	0.39	CDHXB12
1,3R,4,4X,12	IP66	R/Y	5.7/145	O/I & Off/On	Yes	Yes	0.39	CDHXY12
1,3R,4,4X,12	IP66	Blk	6.9/175	O/I & Off/On	Yes	Yes	0.41	CDHXB22
1,3R,4,4X,12	IP65	Metal	8.7/220	Off/On	—	Yes	1.50	BDH8

Shafts — for use with pistol handles □ .47 x .47" (□ 12 x 12 mm)

Shaft length inches/mm	Mounting depth ^① in inches	Weight (lbs)	Catalog number
11.0/280	10.2 – 14.5	0.77	BDS280
12.8/325	12.0 – 16.3	0.90	BDS325
15.6/395	14.8 – 19.1	1.10	BDS395
18.3/465	17.5 – 21.9	1.32	BDS465
21.1/535	20.3 – 24.6	1.54	BDS535

Twisted shafts — Rotates handle 45° □ .47 x .47" (□ 12 x 12 mm)

Shaft length inches/mm	Mounting depth ^① in inches	Weight (lbs)	Catalog number
11.0/280	10.2 – 14.5	0.77	BDS28045
12.8/325	12.0 – 16.3	0.90	BDS32545
18.3/465	17.5 – 21.9	1.32	BDS46545

^① Mounting depth is the distance from the outside of the door to the disconnect switch mounting plate. Shaft can be cut to desired length.



For additional information and detail, see the Bussmann Disconnect Switch Catalog, Item Number 3006

For complete specification data, call Bussmann Information Fax ~ 636.527.1450

for 400A – 800A Non-Fusible Disconnect Switches



BDTL26

BDTL27



BDTL30

BDTL175/400



BDTL32

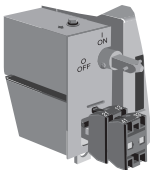

BDAUX1-6

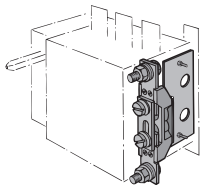

BDZX85

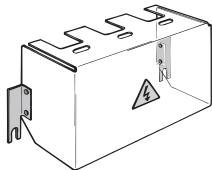

BDTS_

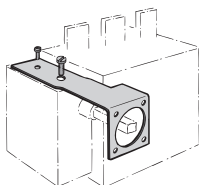

BDZX71

Terminal lug kits

For use on:	Wire size	Kit weight (lbs.)	Wire type	Terminal lugs per kit	Kit catalog number
BDNF400	#2 – 600 kcmil	3.50	CU/AL	6	BDTL26
BDNF400	(2) #2 – 500 kcmil	4.62	CU/AL	6	BDTL262
BDNF600A	(2) #2 – 600 kcmil	4.62	CU/AL	6	BDTL27
BDNF800A	(2) #2 – 600 kcmil	6.90	CU/AL	6	BDTL30
BDNF800A1	(8) 2/0 + (2)#2 600 kcmil	6.90	CU/AL	3	BDTL32
BDNF400 – BDNF600A ^①	(12) #14 – 6	1.10	CU/AL	3	BDTL175/400

Auxiliary contacts ^②

Description	For use on:	Weight (lbs)	ac thermal amp rating	ac rated voltage	Catalog number
1 N.O. + 1 N.C.	BDNF400 – BDNF800A	0.20	10	600	BDAUX1
2 N.O. + 2 N.C.		0.26	10	600	BDAUX2
4 N.O. + 4 N.C.		0.40	10	600	BDAUX3
2 N.O.		0.18	10	600	BDAUX4
4 N.O.		0.25	10	600	BDAUX5
8 N.O.		0.40	10	600	BDAUX6

Terminal poles

Description	For use on:	Weight (lbs)	ac thermal amp rating	ac rated voltage	Catalog number
Detachable neutral mounts on side of switch or DIN rail	BDNF400 – BDNF600A	1.04	400	600	BDZX85

Terminal shrouds

Description	For use on:	Weight (lbs)		Catalog number
Includes one shroud for line or load side	BDNF400	0.62		BDTS4
	BDNF600A	0.66		BDTS6A
	BDNF800A	0.88		BDTS8A

Handle support bracket

Description	For use on:	Weight (lbs)		Catalog number
Allows handle to be directly mounted to switch behind the door	BDNF400 – BDNF600A	0.51		BDZX73
	BDNF800A	0.88		BDZX71

① A load side distribution lug eliminates the need to purchase, install and wire a separate distribution block.

② UL File E57057

For additional information and detail, see the Bussmann Disconnect Switch Catalog, Item Number 3006



30A – 800A



EFJ30X-3PB6

3 Pole^①, 600V, 30A – 3150A

UL General purpose amp rating	Fuse Type	NEMA / UL Enclosure type			
		1	3R	4	4X Stainless
		Catalog number	Catalog number	Catalog number	Catalog number
30	J	EFJ301-3PB6	EFJ303-3PB6	EFJ304-3PB6	EFJ30X-3PB6
30	CC	EFC301-3PB6	EFC303-3PB6	EFC304-3PB6	EFC30X-3PB6
60	J ^②	EFJ601-3PB6	EFJ603-3PB6	EFJ604-3PB6	EFJ60X-3PB6
100	J ^②	EFJ1001-3PB8	EFJ1003-3PB8	EFJ1004-3PB8	EFJ100X-3PB8
200	J ^②	EFJ2001-3PB4	EFJ2003-3PB4	EFJ2004-3PB4	EFJ200X-3PB4
400	J ^②	EFJ4001-3PB4	EFJ4003-3PB4	EFJ4004-3PB4	EFJ400X-3PB4
600	J ^②	EFJ6001-3PB4	EFJ6003-3PB4	EFJ6004-3PB4	EFJ600X-3PB4
800	J ^②	EFL8001-3PB4	EFL8003-3PB4	EFL8004-3PB4	EFL800X-3PB4

Switch ratings

UL general purpose amp rating	Maximum horsepower rating								Wire size for terminal lugs	For wire type	Approval ^①
	Single phase			Three phase							
	120V	200V	240V	200V	208V	240V	480V	600V			
30	2	3	5	5	7.5	7.5	15	20	#18 – 8	CU	CSA, UL
60	3	7.5	10	15	15	15	30	50	#14 – 4	CU	CSA, UL
100	5	10	15	25	25	30	60	75	#14 – 2/0	CU/AL	CSA, UL
200	—	—	—	50	50	60	125	150	#6 – 300 kcmil	CU/AL	CSA, UL
400	—	—	—	100	125	125	250	350	#2 – 600 kcmil	CU/AL	CSA, UL
600	—	—	—	150	150	200	400	500	(2) #2 – 600 kcmil	CU/AL	CSA, UL
800	—	—	—	200	200	250	500	600	(2) #2 – 600 kcmil	CU/AL	CSA, UL

① Fusible switches are UL listed to the UL98 standard.

② 600V T type fuse clips may be substituted at no charge. Please change the second character of the catalog number from "J" to "T."



For additional information and detail, see the Bussmann Disconnect Switch Catalog, Item Number 3006

For complete specification data, call Bussmann Information Fax ~ 636.527.1450

30A – 800A



EFJ607-3P

3 Pole^①, 600V, 30A – 3150A

UL General purpose amp rating	Fuse Type	NEMA / UL Enclosure type			
		4X Plastic Catalog number	12 Catalog number	7 & 9 Catalog number	
	30	J	EFJ30P-3PB6	EFJ302-3PB6	EFJ307-3PB
	30	CC	EFC30P-3PB6	EFC302-3PB6	EFC307-3PB
	60	J ^②	EFJ60P-3PB8	EFJ602-3PB6	EFJ607-3PB
	100	J ^②	EFJ100P-3PB8	EFJ1002-3PB8	EFJ1007-3PB
	200	J ^②	EFJ200P-3PB4	EFJ2002-3PB4	EFJ2007-3PB
	400	J ^②	EFJ400P-3PB4	EFJ4002-3PB4	EFJ4007-3PB
	600	J ^②	EFJ600P-3PB4	EFJ6002-3PB4	EFJ6007-3PB
	800	J ^②	EFL800P-3PB4	EFL8002-3PB4	EFL8007-3PB

Handle ratings

Amperage range	Style type	NEMA	Color	Marking	Defeatable	Padlockable	Catalog number suffix	Catalog number
30	Selector	1,3R,12	Black	0/I & Off/On	Yes	Yes	BJ	CDH5S
	Selector	1,3R,12	Red/Yel	0/I & Off/On	Yes	Yes	YJ	CDH6S
	Pistol	1,3R,12	Black	0/I & Off/On	Yes	Yes	B6	BDH106
	Pistol	1,3R,12	Red/Yel	0/I & Off/On	Yes	Yes	Y6	BDH107
	Pistol	1,3R,4,4X,12	Black	0/I & Off/On	Yes	Yes	B6	CDHXB65
60 – 100	Pistol	1,3R,12	Red/Yel	0/I & Off/On	Yes	Yes	Y6	CDHXY65
	Pistol	1,3R,12	Black	0/I & Off/On	Yes	Yes	B6	BDH58
	Pistol	1,3R,12	Red/Yel	0/I & Off/On	Yes	Yes	Y6	BDH59
	Pistol	1,3R,12	Black	0/I & Off/On	Yes	Yes	B8	BDH60
	Pistol	1,3R,12	Red/Yel	0/I & Off/On	Yes	Yes	Y8	BDH61
200 – 800	Pistol	1,3R,4,4X,12	Black	0/I & Off/On	Yes	Yes	B8	CDHXB86
	Pistol	1,3R,4,4X,12	Red/Yel	0/I & Off/On	Yes	Yes	Y8	CDHXY86
	Pistol	1,3R,12	Black	0/I & Off/On	Yes	Yes	B4	BDH114
	Pistol	1,3R,12	Red/Yel	0/I & Off/On	Yes	Yes	Y4	BDH115
	Pistol	1,3R,12	Black	0/I & Off/On	Yes	Yes	B7	BDH116
	Pistol	1,3R,12	Red/Yel	0/I & Off/On	Yes	Yes	Y7	BDH117
	Pistol	1,3R 4,4X,12	Black	0/I & Off/On	Yes	Yes	B4	CDHXB12
	Pistol	1,3R,4,4X,12	Red/Yel	0/I & Off/On	Yes	Yes	Y4	CDHXY12
	Pistol	1,3R,4,4X,12	Black	0/I & Off/On	Yes	Yes	B7	CDHXB22
	Pistol	1,3R,4,4X,12	Red/Yel	0/I & Off/On	Yes	Yes	Y7	CDHXY22
	Pistol	1,3R,4,4X,12	Metal	0/I & Off/On	No	Yes	8	BDH8

① Fusible switches are UL listed to the UL98 standard.

② 600V T type fuse clips may be substituted at no charge. Please change the second character of the catalog number from "J" to "T."

For additional information and detail, see the Bussmann Disconnect Switch Catalog, Item Number 3006



for Enclosed Fusible Disconnect Switches 30A – 800A

UL general purpose amp rating	Type of Switch	NEMA Enclosure type			
		1 Catalog number	3R Catalog number	4 Catalog number	4X Stainless Catalog number
30 (J fuses)	4 Pole ^①	EFJ301-4PB6	EFJ303-4PB6	EFJ304-4PB6	EFJ30X-4PB6
	6 Pole	EFJ301-6PB6	EFJ303-6PB6	EFJ304-6PB6	EFJ30X-6PB6
	Transfer	EFJ301-3TB8	EFJ303-3TB8	EFJ304-3TB8	EFJ30X-3TB8
	Bypass	EFJ301-3BB6	EFJ303-3BB6	EFJ304-3BB6	EFJ30X-3BB6
	Mech. interlock	EFJ301-3MB6	EFJ303-3MB6	EFJ304-3MB6	EFJ30X-3MB6
30 (CC fuses)	4 Pole ^①	EFC301-4PB6	EFC303-4PB6	EFC304-4PB6	EFC30X-4PB6
	6 Pole	EFC301-6PB6	EFC303-6PB6	EFC304-6PB6	EFC30X-6PB6
	Transfer	EFC301-3TB8	EFC303-3TB8	EFC304-3TB8	EFC30X-3TB8
	Bypass	EFC301-3BB6	EFC303-3BB6	EFC304-3BB6	EFC30X-3BB6
	Mech. interlock	EFC301-3MB6	EFC303-3MB6	EFC304-3MB6	EFC30X-3MB6
60	4 Pole ^①	EFJ601-4PB6	EFJ603-4PB6	EFJ604-4PB6	EFJ60X-4PB6
	6 Pole	EFJ601-6PB4	EFJ603-6PB4	EFJ604-6PB4	EFJ60X-6PB4
	Transfer	EFJ601-3TB8	EFJ603-3TB8	EFJ604-3TB8	EFJ60X-3TB8
	Mech. interlock	EFJ601-3MB6	EFJ603-3MB6	EFJ604-3MB6	EFJ60X-3MB6
100	2 Pole ^①	EFJ1001-2PB8	EFJ1003-2PB8	EFJ1004-2PB8	EFJ100X-2PB8
	4 Pole ^①	EFJ1001-4PB8	EFJ1003-4PB8	EFJ1004-4PB8	EFJ100X-4PB8
	6 Pole	EFJ1001-6PB4	EFJ1003-6PB4	EFJ1004-6PB4	EFJ100X-6PB4
	Transfer	EFJ1001-3TB8	EFJ1003-3TB8	EFJ1004-3TB8	EFJ100X-3TB8
	Mech. interlock	EFJ1001-3MB8	EFJ1003-3MB8	EFJ1004-3MB8	EFJ100X-3MB8
200	2 Pole ^①	EFJ2001-2PB8	EFJ2003-2PB8	EFJ2004-2PB8	EFJ200X-2PB8
	4 Pole ^①	EFJ2001-4PB4	EFJ2003-4PB4	EFJ2004-4PB4	EFJ200X-4PB4
	6 Pole	EFJ2001-6P8	EFJ2003-6P8	EFJ2004-6P8	EFJ200X-6P8
	Transfer	EFJ2001-3TB4	EFJ2003-3TB4	EFJ2004-3TB4	EFJ200X-3TB4
	Mech. interlock	EFJ2001-3B6	EFJ2003-3B6	EFJ2004-3B6	EFJ200X-3B6
400	2 Pole ^①	EFJ4001-2PB4	EFJ4003-2PB4	EFJ4004-2PB4	EFJ400X-2PB4
	4 Pole ^①	EFJ4001-4PB4	EFJ4003-4PB4	EFJ4004-4PB4	EFJ400X-4PB4
	6 Pole	EFJ4001-6P8	EFJ4003-6P8	EFJ4004-6P8	EFJ400X-6P8
	Transfer	EFJ4001-3TB4	EFJ4003-3TB4	EFJ4004-3TB4	EFJ400X-3TB4
	Mech. interlock	EFJ4001-3B6	EFJ4003-3B6	EFJ4004-3B6	EFJ400X-3B6
600	2 Pole ^①	EFJ6001-2PB4	EFJ6003-2PB4	EFJ6004-2PB4	EFJ600X-2PB4
	4 Pole ^①	EFJ6001-4PB4	EFJ6003-4PB4	EFJ6004-4PB4	EFJ600X-4PB4
	6 Pole	EFJ6001-6P8	EFJ6003-6P8	EFJ6004-6P8	EFJ600X-6P8
	Transfer	EFJ6001-3TB4	EFJ6003-3TB4	EFJ6004-3TB4	EFJ600X-3TB4
	Mech. interlock	EFJ6001-3B6	EFJ6003-3B6	EFJ6004-3B6	EFJ600X-3B6
800	2 Pole ^①	EFL8001-2PB4	EFL8003-2PB4	EFL8004-2PB4	EFL800X-2PB4
	4 Pole ^①	EFL8001-4PB4	EFL8003-4PB4	EFL8004-4PB4	EFL800X-4PB4
	6 Pole	EFL8001-6P8	EFL8003-6P8	EFL8004-6P8	EFL800X-6P8
	Transfer	EFL8001-3TB4	EFL8003-3TB4	EFL8004-3TB4	EFL800X-3TB4
	Mech. interlock	EFL8001-3B6	EFL8003-3B6	EFL8004-3B6	EFL800X-3B6

2 Pole



4 Pole

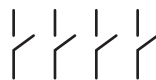

6 Pole



① IEC rated only.

② ≡ = Three poles



For additional information and detail, see the Bussmann Disconnect Switch Catalog, Item Number 3006

For complete specification data, call Bussmann Information Fax ~ 636.527.1450

for Enclosed Fusible Disconnect Switches 30A – 800A

UL General purpose amp rating	Type of Switch	NEMA Enclosure type		
		4X Plastic Catalog number	12 Catalog number	7 & 9 Catalog number
30 (J fuses)	4 Pole ^①	EFJ30P-4PB6	EFJ302-4PB6	②
	6 Pole	EFJ30P-6PB6	EFJ302-6PB6	
	Transfer	EFJ30P-3TB8	EFJ302-3TB8	
	Bypass	EFJ30P-3BB6	EFJ302-3BB6	
	Mech. interlock	EFJ30P-3MB6	EFJ302-3MB6	
30 (CC fuses)	4 Pole ^①	EFC30P-4PB6	EFC302-4PB6	②
	6 Pole	EFC30P-6PB6	EFC302-6PB6	
	Transfer	EFC30P-3TB8	EFC302-3TB8	
	Bypass	EFC30P-3BB6	EFC302-3BB6	
	Mech. interlock	EFC30P-3MB6	EFC302-3MB6	
60	4 Pole ^①	EFJ60P-4PB6	EFJ602-4PB6	②
	6 Pole	EFJ60P-6PB4	EFJ602-6PB4	
	Transfer	EFJ60P-3TB8	EFJ602-3TB8	
	Mech. interlock	EFJ60P-3MB6	EFJ602-3MB6	
100	2 Pole ^①	EFJ100P-2PB8	EFJ1002-2PB8	②
	4 Pole ^①	EFJ100P-4PB8	EFJ1002-4PB8	
	6 Pole	EFJ100P-6PB4	EFJ1002-6PB4	
	Transfer	EFJ100P-3TB8	EFJ1002-3TB8	
	Mech. interlock	EFJ100P-3MB8	EFJ1002-3MB8	
200	2 Pole ^①	EFJ200P-2PB8	EFJ2002-2PB8	②
	4 Pole ^①	EFJ200P-4PB4	EFJ2002-4PB4	
	6 Pole	EFJ200P-6P8	EFJ2002-6P8	
	Transfer	EFJ200P-3TB4	EFJ2002-3TB4	
	Bypass	EFJ200P-3B6	EFJ2002-3B6	
	Mech. interlock	EFJ200P-3MB4	EFJ2002-3MB4	
400	2 Pole ^①	EFJ400P-2PB4	EFJ4002-2PB4	②
	4 Pole ^①	EFJ400P-4PB4	EFJ4002-4PB4	
	6 Pole	EFJ400P-6P8	EFJ4002-6P8	
	Transfer	EFJ400P-3TB4	EFJ4002-3TB4	
	Mech. interlock	EFJ400P-3MB4	EFJ4002-3MB4	
600	2 Pole ^①	EFJ600P-2PB4	EFJ6002-2PB4	②
	4 Pole ^①	EFJ600P-4PB4	EFJ6002-4PB4	
	6 Pole	EFJ600P-6P8	EFJ6002-6P8	
	Transfer	EFJ600P-3TB4	EFJ6002-3TB4	
	Mech. interlock	EFJ600P-3B6	EFJ6002-3B6	
800	2 Pole ^①	EFL800P-2PB4	EFL8002-2PB4	②
	4 Pole ^①	EFL800P-4PB4	EFL8002-4PB4	
	6 Pole	EFL800P-6P8	EFL8002-6P8	
	Transfer	EFL800P-3TB4	EFL8002-3TB4	
	Mech. interlock	EFL800P-3B6	EFL8002-3B6	

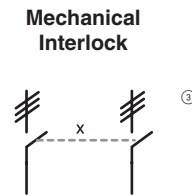
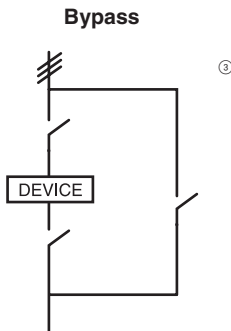
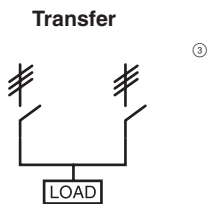

① IEC rated only.
 ② Consult factory for pricing and availability.
 ③ ≡ Three poles

For additional information and detail, see the Bussmann Disconnect Switch Catalog, Item Number 3006



16A – 3150A



ENF321-3PBJ

ENF63X-3PB6

3 Pole, 600V, 16A – 100A — Selector handle

UL general purpose amp rating	NEMA Enclosure type			
	1	3R	41 Selector handles are only NEMA rated 1, 3R, 12	4X Stainless ^① Selector handles are only NEMA rated 1, 3R, 12
	Catalog number	Catalog number	Catalog number	Catalog number
16	ENF161-3PBJ	ENF163-3PBJ	ENF164-3PBJ	ENF16X-3PBJ
25	ENF251-3PBJ	ENF253-3PBJ	ENF254-3PBJ	ENF25X-3PBJ
40	ENF321-3PBJ	ENF323-3PBJ	ENF324-3PBJ	ENF32X-3PBJ
60	ENF451-3PBJ	ENF453-3PBJ	ENF454-3PBJ	ENF45X-3PBJ
80	ENF631-3PBJ	ENF633-3PBJ	ENF634-3PBJ	ENF63X-3PBJ

3 Pole, 600V, 16A – 3150A — Pistol handle

UL general purpose amp rating	NEMA Enclosure type				
	1	3R	4	4X Stainless	
	Catalog number	Catalog number	Catalog number	Catalog number	
UL 508	16	ENF161-3PB6	ENF163-3PB6	ENF164-3PB6	ENF16X-3PB6
	25	ENF251-3PB6	ENF253-3PB6	ENF254-3PB6	ENF25X-3PB6
	40	ENF321-3PB6	ENF323-3PB6	ENF324-3PB6	ENF32X-3PB6
	60	ENF451-3PB6	ENF453-3PB6	ENF454-3PB6	ENF45X-3PB6
	80	ENF631-3PB6	ENF633-3PB6	ENF634-3PB6	ENF63X-3PB6
UL 98	30	ENF301-3PB6	ENF303-3PB6	ENF304-3PB6	ENF30X-3PB6
	60	ENF601-3PB6	ENF603-3PB6	ENF604-3PB6	ENF60X-3PB6
	100	ENF1001-3PB6	ENF1003-3PB6	ENF1004-3PB6	ENF100X-3PB6
	125	ENF1251-3PB6	ENF1253-3PB6	ENF1254-3PB6	ENF125X-3PB6
	200	ENF2001-3PB8	ENF2003-3PB8	ENF2004-3PB8	ENF200X-3PB8
	400	ENF4001-3PB4	ENF4003-3PB4	ENF4004-3PB4	ENF400X-3PB4
	600	ENF6001-3PB4	ENF6003-3PB4	ENF6004-3PB4	ENF600X-3PB4
	800	ENF8001-3PB4	ENF8003-3PB4	ENF8004-3PB4	ENF800X-3PB4
	1200	ENF12001-3PB4	ENF12003-3PB4	ENF12004-3PB4	ENF1200X-3PB4
	1600	ENF16001-3P8	ENF16003-3P8	ENF16004-3P8	ENF1600X-3P8
	2000	ENF20001-3P8	ENF20003-3P8	ENF20004-3P8	ENF2000X-3P8
3150 ^②	ENF31501-3P8	ENF31503-3P8	ENF31504-3P8	ENF3150X-3P8	

① Enclosures are rated as listed, selector handles are only NEMA rated 1, 3R, 12. The overall NEMA rating of an enclosed switch with a selector handle is 1, 3R, 12.
 ② IEC rated only.



For additional information and detail, see the Bussmann Disconnect Switch Catalog, Item Number 3006

For complete specification data, call Bussmann Information Fax ~ 636.527.1450

16A – 3150A

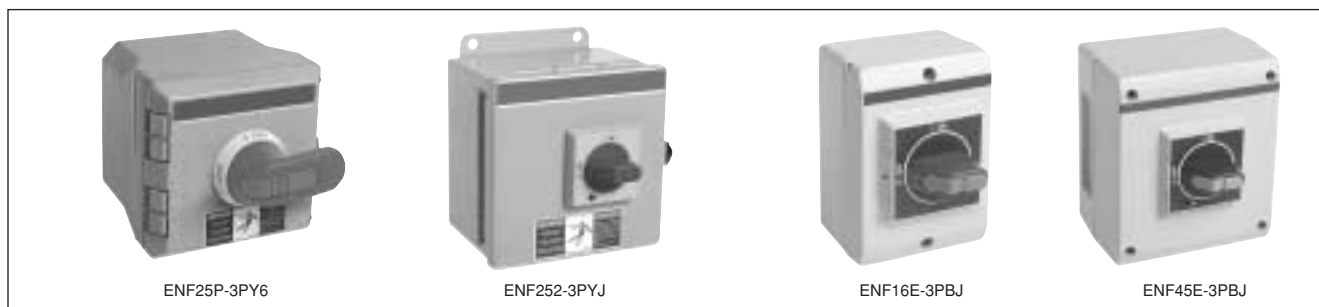

3 Pole, 600V, 16A – 100A — Selector handle

UL general purpose amp rating	NEMA Enclosure type			IEC Enclosure type
	4X Plastic ^① Selector handles are only NEMA rated 1, 3R, 12	12	7 & 9	IP65 Plastic
	Catalog number	Catalog number	Catalog number	Catalog number
16	ENF16P-3PBJ	ENF162-3PBJ	—	ENF16E-3PBJ
25	ENF25P-3PBJ	ENF252-3PBJ	—	ENF25E-3PBJ
40	ENF32P-3PBJ	ENF322-3PBJ	—	ENF32E-3PBJ
60	ENF45P-3PBJ	ENF452-3PBJ	—	ENF45E-3PBJ
80	ENF63P-3PBJ	ENF632-3PBJ	—	ENF63E-3PBJ

3 Pole, 600V, 16A – 3150A — Pistol handle

UL general purpose amp rating	NEMA Enclosure type			IEC Enclosure type
	4X Plastic	12	7 & 9	IP65 Plastic
	Catalog number	Catalog number	Catalog number	Catalog number
16	ENF16P-3PB6	ENF162-3PB6	ENF167-3P	ENF16E-3PB4
25	ENF25P-3PB6	ENF252-3PB6	ENF257-3P	ENF25E-3PB4
40	ENF32P-3PB6	ENF322-3PB6	ENF327-3P	ENF32E-3PB4
60	ENF45P-3PB6	ENF452-3PB6	ENF457-3P	ENF45E-3PB4
80	ENF63P-3PB6	ENF632-3PB6	ENF637-3P	ENF63E-3PB4
30	ENF30P-3PB6	ENF302-3PB6	ENF307-3P	ENF30E-3PB6
60	ENF60P-3PB6	ENF602-3PB6	ENF607-3P	ENF60E-3PB6
100	ENF100P-3PB6	ENF1002-3PB6	ENF1007-3P	ENF100E-3PB6
125	ENF125P-3PB6	ENF1252-3PB6	ENF1257-3P	ENF125E-3PB6
200	ENF200P-3PB8	ENF2002-3PB8	ENF2007-3P	—
400	ENF400P-3PB4	ENF4002-3PB4	ENF4007-3P	—
600	ENF600P-3PB4	ENF6002-3PB4	ENF6007-3P	—
800	ENF800P-3PB4	ENF8002-3PB4	ENF8007-3P	—
1200	ENF1200P-3PB4	ENF12002-3PB4	ENF12007-3P	—
1600	ENF1600P-3P8	ENF16002-3P8	ENF16007-3P	—
2000	ENF2000P-3P8	ENF20002-3P8	ENF20007-3	—
3150 ^②	ENF3150P-3P8	ENF31502-3P8	ENF31507-3P	—

NOTE: All enclosed switches are provided with a black handle; however, most handles can be substituted with a red and yellow handle if desired. Please substitute the handle suffix code (2nd and 3rd from last characters) with the red/yellow handle catalog number suffix from page 3.12. There is no additional price adder for changing to a red/yellow handle of equal ratings and style.

EXAMPLE: A red/yellow selector handle for an ENF161-3PBJA can be substituted for the black selector handle by using the "YJ" suffix instead of the "BJ" suffix, new catalog #ENF161-3PYJA.

① Enclosures are rated as listed, selector handles are only NEMA rated 1, 3R, 12. The overall NEMA rating of an enclosed switch with a selector handle is 1, 3R, 12.
 ② IEC rated only.

For additional information and detail, see the Bussmann Disconnect Switch Catalog, Item Number 3006



16A – 400A Other Configurations

UL General purpose amp rating	Type of switch	NEMA Enclosure type			
		1	3R	4	4X Stainless
		Catalog number	Catalog number	Catalog number	Catalog number
16	4 Pole	ENF161-4PB6	ENF163-4PB6	ENF164-4PB6	ENF16X-4PB6
	6 Pole	ENF161-6PB6	ENF163-6PB6	ENF164-6PB6	ENF16X-6PB6
	Transfer	ENF161-3TB8	ENF163-3TB8	ENF164-3TB8	ENF16X-3TB8
	Bypass	ENF161-3BB8	ENF163-3BB8	ENF164-3BB8	ENF16X-3BB8
	Mech. interlock	ENF161-3MB6	ENF163-3MB6	ENF164-3MB6	ENF16X-3MB6
25	4 Pole	ENF251-4PB6	ENF253-4PB6	ENF254-4PB6	ENF25X-4PB6
	6 Pole	ENF251-6PB6	ENF253-6PB6	ENF254-6PB6	ENF25X-6PB6
	Transfer	ENF251-3TB8	ENF253-3TB8	ENF254-3TB8	ENF25X-3TB8
	Bypass	ENF251-3BB8	ENF253-3BB8	ENF254-3BB8	ENF25X-3BB8
	Mech. interlock	ENF251-3MB6	ENF253-3MB6	ENF254-3MB6	ENF25X-3MB6
40	4 Pole	ENF321-4PB6	ENF323-4PB6	ENF324-4PB6	ENF32X-4PB6
	6 Pole	ENF321-6PB6	ENF323-6PB6	ENF324-6PB6	ENF32X-6PB6
	Transfer	ENF321-3TB8	ENF323-3TB8	ENF324-3TB8	ENF32X-3TB8
	Bypass	ENF321-3BB8	ENF323-3BB8	ENF324-3BB8	ENF32X-3BB8
	Mech. interlock	ENF321-3MB6	ENF323-3MB6	ENF324-3MB6	ENF32X-3MB6
60	4 Pole	ENF451-4PB6	ENF453-4PB6	ENF454-4PB6	ENF45X-4PB6
	6 Pole	ENF451-6PB6	ENF453-6PB6	ENF454-6PB6	ENF45X-6PB6
	Transfer	ENF451-3TB8	ENF453-3TB8	ENF454-3TB8	ENF45X-3TB8
	Bypass	ENF451-3BB8	ENF453-3BB8	ENF454-3BB8	ENF45X-3BB8
	Mech. interlock	ENF451-3MB6	ENF453-3MB6	ENF454-3MB6	ENF45X-3MB6
80	4 Pole	ENF631-4PB6	ENF633-4PB6	ENF634-4PB6	ENF63X-4PB6
	6 Pole	ENF631-6PB6	ENF633-6PB6	ENF634-6PB6	ENF63X-6PB6
	Transfer	ENF631-3TB8	ENF633-3TB8	ENF634-3TB8	ENF63X-3TB8
	Bypass	ENF631-3BB8	ENF633-3BB8	ENF634-3BB8	ENF63X-3BB8
	Mech. interlock	ENF631-3MB6	ENF633-3MB6	ENF634-3MB6	ENF63X-3MB6
30	4 Pole	ENF301-4PB6	ENF303-4PB6	ENF304-4PB6	ENF30X-4PB6
	6 Pole	ENF301-6PB6	ENF303-6PB6	ENF304-6PB6	ENF30X-6PB6
	Transfer	ENF301-3TB8	ENF303-3TB8	ENF304-3TB8	ENF30X-3TB8
	Bypass	ENF301-3BB8	ENF303-3BB8	ENF304-3BB8	ENF30X-3BB8
	Mech. interlock	ENF301-3MB6	ENF303-3MB6	ENF304-3MB6	ENF30X-3MB6
60	4 Pole	ENF601-4PB6	ENF603-4PB6	ENF604-4PB6	ENF60X-4PB6
	6 Pole	ENF601-6PB6	ENF603-6PB6	ENF604-6PB6	ENF60X-6PB6
	Transfer	ENF601-3TB8	ENF603-3TB8	ENF604-3TB8	ENF60X-3TB8
	Bypass	ENF601-3BB8	ENF603-3BB8	ENF604-3BB8	ENF60X-3BB8
	Mech. interlock	ENF601-3MB6	ENF603-3MB6	ENF604-3MB6	ENF60X-3MB6
100	4 Pole	ENF1001-4PB6	ENF1003-4PB6	ENF1004-4PB6	ENF100X-4PB6
	6 Pole	ENF1001-6PB6	ENF1003-6PB6	ENF1004-6PB6	ENF100X-6PB6
	Transfer	ENF1001-3TB8	ENF1003-3TB8	ENF1004-3TB8	ENF100X-3TB8
	Bypass	ENF1001-3BB8	ENF1003-3BB8	ENF1004-3BB8	ENF100X-3BB8
	Mech. interlock	ENF1001-3MB6	ENF1003-3MB6	ENF1004-3MB6	ENF100X-3MB6
125	2 Pole	ENF1251-2PB6	ENF1253-2PB6	ENF1254-2PB6	ENF125X-2PB6
	4 Pole	ENF1251-4PB6	ENF1253-4PB6	ENF1254-4PB6	ENF125X-4PB6
	6 Pole	ENF1251-6PB2	ENF1253-6PB2	ENF1254-6PB4	ENF125X-6PB4
	Transfer	ENF1251-3TB8	ENF1253-3TB8	ENF1254-3TB8	ENF125X-3TB8
	Mech. interlock	ENF1251-3MB6	ENF1253-3MB6	ENF1254-3MB8	ENF125X-3MB8
200	2 Pole	ENF2001-2PB8	ENF2003-2PB8	ENF2004-2PB8	ENF200X-2PB8
	4 Pole	ENF2001-4PB8	ENF2003-4PB8	ENF2004-4PB8	ENF200X-4PB8
	6 Pole	ENF2001-6PB4	ENF2003-6PB4	ENF2004-6PB4	ENF200X-6PB4
	Transfer	ENF2001-3TB4	ENF2003-3TB4	ENF2004-3TB4	ENF200X-3TB4
	Mech. interlock	ENF2001-3BB4	ENF2003-3BB4	ENF2004-3BB4	ENF200X-3BB4
400	2 Pole	ENF4001-2PB4	ENF4003-2PB4	ENF4004-2PB4	ENF400X-2PB4
	4 Pole	ENF4001-4PB4	ENF4003-4PB4	ENF4004-4PB4	ENF400X-4PB4
	6 Pole	ENF4001-6P8	ENF4003-6P8	ENF4004-6P8	ENF400X-6P8
	Transfer	ENF4001-3TB4	ENF4003-3TB4	ENF4004-3TB4	ENF400X-3TB4
	Mech. interlock	ENF4001-3B6	ENF4003-3B6	ENF4004-3B6	ENF400X-3B6
		ENF4001-3MB4	ENF4003-3MB4	ENF4004-3MB4	ENF400X-3MB4



For additional information and detail, see the Bussmann Disconnect Switch Catalog, Item Number 3006

For complete specification data, call Bussmann Information Fax ~ 636.527.1450

16A – 400A Other Configurations

UL General purpose amp rating	Type of switch	NEMA Enclosure type			IEC Enclosure type
		4X Plastic	12	7 & 9	IP65
		Catalog number	Catalog number	Catalog number	Catalog number
16	4 pole	ENF16P-4PB6	ENF162-4PB6	ENF167-4P	ENF16E-4PBJ
	6 pole	ENF16P-6PB6	ENF162-6PB6	ENF167-6P	ENF16E-6PBJ
	Transfer	ENF16P-3TB8	ENF162-3TB8	ENF167-3T	—
	Bypass	ENF16P-3BB8	ENF162-3BB8	ENF167-3B	—
	Mech. interlock	ENF16P-3MB6	ENF162-3MB6	—	—
25	4 pole	ENF25P-4PB6	ENF252-4PB6	ENF257-4P	ENF25E-4PBJ
	6 pole	ENF25P-6PB6	ENF252-6PB6	ENF257-6P	ENF25E-6PBJ
	Transfer	ENF25P-3TB8	ENF252-3TB8	ENF257-3T	—
	Bypass	ENF25P-3BB8	ENF252-3BB8	ENF257-3B	—
	Mech. interlock	ENF25P-3MB6	ENF252-3MB6	—	—
40	4 Pole	ENF32P-4PB6	ENF322-4PB6	ENF327-4P	ENF32E-4PBJ
	6 Pole	ENF32P-6PB6	ENF322-6PB6	ENF327-6P	ENF32E-6PBJ
	Transfer	ENF32P-3TB8	ENF322-3TB8	ENF327-3T	—
	Bypass	ENF32P-3BB8	ENF323-3BB8	ENF327-3B	—
	Mech. interlock	ENF32P-3MB6	ENF322-3MB6	—	—
60	4 Pole	ENF45P-4PB6	ENF452-4PB6	ENF457-4P	ENF45E-4PBJ
	6 Pole	ENF45P-6PB6	ENF452-6PB6	ENF457-6P	ENF45E-6PBJ
	Transfer	ENF45P-3TB8	ENF452-3TB8	ENF457-3T	—
	Bypass	ENF45P-3BB8	ENF452-3BB8	ENF457-3B	—
	Mech. interlock	ENF45P-3MB6	ENF452-3MB6	—	—
80	4 Pole	ENF63P-4PB6	ENF632-4PB6	ENF637-4P	ENF63E-4PBJ
	6 Pole	ENF63P-6PB6	ENF632-6PB6	ENF637-6P	ENF63E-6PBJ
	Transfer	ENF63P-3TB8	ENF632-3TB8	ENF637-3T	—
	Bypass	ENF63P-3BB8	ENF632-3BB8	ENF637-3B	—
	Mech. interlock	ENF63P-3MB6	ENF632-3MB6	—	—
30	4 Pole	ENF30P-4PB6	ENF302-4PB6	ENF307-4P	ENF30E-4PB4
	6 Pole	ENF30P-6PB6	ENF302-6PB6	ENF307-6P	ENF30E-6PB6
	Transfer	ENF30P-3TB8	ENF302-3TB8	ENF307-3T	—
	Bypass	ENF30P-3BB8	ENF302-3BB8	ENF307-3B	—
	Mech. interlock	ENF30P-3MB6	ENF302-3MB6	—	—
60	4 Pole	ENF60P-4PB6	ENF602-4PB6	ENF607-4P	ENF60E-4PB4
	6 Pole	ENF60P-6PB6	ENF602-6PB6	ENF607-6P	ENF60E-6PB6
	Transfer	ENF60P-3TB8	ENF602-3TB8	ENF607-3T	—
	Bypass	ENF60P-3BB8	ENF602-3BB8	ENF607-3B	—
	Mech. interlock	ENF60P-3MB6	ENF602-3MB6	—	—
100	4 Pole	ENF100P-4PB6	ENF1002-4PB6	ENF1007-4P	ENF100E-4PB4
	6 Pole	ENF100P-6PB6	ENF1002-6PB6	ENF1007-6P	ENF100E-6PB6
	Transfer	ENF100P-3TB8	ENF1002-3TB8	ENF1007-3T	—
	Bypass	ENF100P-3BB8	ENF1002-3BB8	ENF1007-3B	—
	Mech. interlock	ENF100P-3MB6	ENF1002-3MB6	—	—
125	2 Pole	ENF125P-2PB6	ENF1252-2PB6	ENF1257-2P	—
	4 Pole	ENF125P-4PB6	ENF1252-4PB6	ENF1257-4P	—
	6 Pole	ENF125P-6PB2	ENF1252-6PB2	ENF1257-6P	—
	Transfer	ENF125P-3TB8	ENF1252-3TB8	ENF1257-3T	—
	Mech. interlock	ENF125P-3MB6	ENF1252-3MB6	—	—
200	2 Pole	ENF200P-2PB8	ENF2002-2PB8	ENF2007-2P	—
	4 Pole	ENF200P-4PB8	ENF2002-4PB8	ENF2007-4P	—
	6 Pole	ENF200P-6PB4	ENF2002-6PB4	ENF2007-6P	—
	Transfer	ENF200P-3TB4	ENF2002-3TB4	ENF2007-3T	—
	Mech. interlock	ENF200P-3MB8	ENF2002-3MB8	—	—
400	2 Pole	ENF400P-2PB4	ENF4002-2PB4	ENF4007-2P	—
	4 Pole	ENF400P-4PB4	ENF4002-4PB4	ENF4007-4P	—
	6 Pole	ENF400P-6P8	ENF4002-6P8	ENF4007-6P	—
	Transfer	ENF400P-3TB4	ENF4002-3TB4	ENF4007-3T	—
	Mech. interlock	ENF400P-3MB4	ENF4002-3MB4	—	—

For additional information and detail, see the Bussmann Disconnect Switch Catalog, Item Number 3006



Fused, Dead Front, Disconnect Switches



15149 Series

Voltage Ratings: 600Vac, 30A

Agency Information:

UL Recognized, file E116716 for General Industrial installations. Guide WFXV2.

CSA certified, file LR37129-6

- In 2 and 3 poles.
- Class J fuses.
- Fuse holders in the pull-out head eliminate possibility of electric shock while changing fuse.
- Examined under the new proposed standard UL 1429 which imparts a stricter set of test conditions than the former program that combined the applicable portions for UL 512 (Fuse Holders) and UL 98 (Enclosed Switches).

Specifications

Voltage Rating	600V AC (maximum)
Current Rating	0 to 30A
Motor Rating	5 HP
Dielectric Withstand	2200V
Current Withstand	200,000 RMS Symmetrical Amperes

Ordering information:

15149 is available in 2 or 3 poles.

To order: Basic Part No. + number of poles.

Example: 15149-2 = 2-pole device.

CE CE logo denotes compliance with European Union Low Voltage Directive (50-1000Vac, 75-1500Vdc). Refer to Data Sheet: 8002 or contact Bussmann Application Engineering at 636-527-1270 for more information.



Power Module™ —All-in-one Elevator Disconnect



Bussmann® Power Module™

(Fusible switch with shunt trip and fire safety interface to allow for single point tie in with fire alarm system.)



Complies with:

NFPA 70 (NEC®; National Electrical Code®)
ANSI/ASME A17.1 (Safety Code for Elevators
and Escalators)
NFPA 72 (National Fire Alarm Code®)

Features and Accessories:

- Shunt trip 120V
- Accepts LPJ-(amp)SP Class J fuses
- Control Power Transformer
- Fire Safety Interface Relay
- Key to Test Switch
- Pilot Light (on)
- Mechanically Interlocked Auxiliary Contact
- Neutral (200% Capability)
- Control Power Fuses and Blocks
- For added safety, use the Bussmann SAMI fuse covers to improve maintenance personnel protection (OSHA 1910.333, paragraph C).

Voltage Ratings:

600Vac, 3Ø Fused Power Switch

Short-Circuit Current Rating:

200,000A RMS

PS

Power Module™ Switch

(Single Elevator Applications)

Ampere Ratings:

30-400A

Agency Information:

UL Listed (UL 98) Enclosed and Dead front switch
Guide 96NK3917, File E182262
NEMA 1, UL 50 Listed enclosure¹
ULc per Canadian Standards C22.2, No. 0-M91-
CAN/CSA C22.2, No. 4-M89 Enclosed switch.

¹NEMA 12, 3R, and 4 enclosures also available

Data Sheet: 1145

PMP

Power Module™ Panel

(Multiple Elevator Applications)

Ampere Ratings:

Feeder Switches - 30-400A
Main Switches² - 400-800A

Agency Information:

UL Listed (UL 67) Panel Boards or (UL 891)
Dead Front Switchboard, File E181664
ULc per Canadian Standards
Service Entrance Rated

²Contact Bussmann for applications greater than 800A

Data Sheet: 1146



North American Style—General Information



Voltage Rating

130Vac/dc	1000 to 4000A
150Vac/dc	70 to 1000A
250Vac/dc	35 to 2500A
500Vac/dc	35 to 1600A
600Vac	1 to 1000A
700Vac/dc	5 to 1200A
800Vdc	35 to 600A
1000Vac, 700Vdc	35 to 2000A

All Bussmann North American Style fuses are certified for their rated voltage.

Characteristics:

- Low energy let-thru (I^2t)
- Low watts loss
- Superior cycling capability
- Low arc voltage
- Excellent dc performance

North American style fuses provide an excellent solution for medium power applications. While there are currently no published standards for these fuses, the industry has standardized on mounting centers that accept Bussmann fuses.

Accessories

Bussmann offers a comprehensive line of fuse bases that provide the user with design and manufacturing flexibility.



North American Style

FWA 130V

Voltage Rating: 130Vac/130Vdc (130Vdc rating applies to 1000 through 2000A only.)

Interrupting Rating: 200kA RMS Symmetrical.

Agency Information: UL Recognized, Std. 248-13

Watts loss provided at rated current.



Electrical Characteristics

Rated Current RMS-Amps	I _t (A ² SEC) @ 100kA		Watts Loss	Part Number	Carton Qty.	Carton Weight (lbs)
	Pre-arc	Clearing at 130V				
1000	170000	460000	60.0	FWA-1000AH	1	3.3
1200	270000	730000	70.0	FWA-1200AH	1	3.3
1500	520000	1400000	78.0	FWA-1500AH	1	3.3
2000	860000	2400000	108.0	FWA-2000AH	1	3.3
2500	1500000	4100000	130.0	FWA-2500AH	1	3.3
3000	2100000	5700000	150.0	FWA-3000AH	1	3.3
4000	3400000	9200000	257.0	FWA-4000AH	1	3.3

Ordering Information

Data Sheet: 720001

FWA 150V

Voltage Rating: 150Vac/150Vdc (150Vdc rating applies to 70 through 800A only.)

Interrupting Rating: 100kA RMS Symmetrical. (70-400A)
200kA RMS Symmetrical. (450-1000A)

Agency Information: UL Recognized, Std. 248-13

Watts loss provided at rated current.



Electrical Characteristics

Rated Current RMS-Amps	I _t (A ² SEC) @ 100kA		Watts Loss	Part Number	Carton Qty.	Carton Weight (lbs)
	Pre-arc	Clearing at 150V				
70	470	4000	6.9	FWA-70B	10	1.76
80	670	6000	7.7	FWA-80B	10	1.76
100	1200	12000	9.0	FWA-100B	10	1.76
125	1870	18000	11.2	FWA-125B	10	1.76
150	2700	26000	13.5	FWA-150B	10	1.76
200	4780	45000	17.6	FWA-200B	10	1.76
250	7470	70000	22.5	FWA-250B	10	1.76
300	10760	100000	27.0	FWA-300B	10	1.76
350	15700	140000	30.6	FWA-350B	10	1.76
400	20300	180000	35.2	FWA-400B	10	1.76
500	39000	120000	35.0	FWA-500A	5	2.42
600	46000	140000	47.0	FWA-600A	5	2.42
700	75000	220000	49.0	FWA-700A	5	2.42
800	92000	280000	58.0	FWA-800A	5	2.42
1000	170000	510000	60.0	FWA-1000A	5	2.42

Ordering Information

CE logo denotes compliance with European Union Low Voltage Directive (50-1000Vac, 75-1500Vdc). Refer to Data Sheet: 8002 or contact Bussmann Application Engineering at 636-527-1270 for more information.

Data Sheet: 720002



North American Style

FWX 250V

Voltage Rating: 250Vac/250Vdc (250Vdc rating on 35 through 800A only.)

Interrupting Rating: 200kA RMS Symmetrical.

Agency Information:

UL Recognized, Std. 248-13, 35-800A

Watts loss provided at rated current.



Electrical Characteristics

Ordering Information

Rated Current RMS-Amps	I_{t1} (A ² SEC) @ 100kA		Watts Loss	Part Number	Carton Qty.	Carton Weight (lbs)
	Pre-arc	Clearing at 250V				
35	50	230	4.2	FWX-35A	5	1.40
40	60	310	5.2	FWX-40A	5	1.40
45	80	390	5.7	FWX-45A	5	1.40
50	100	520	6.0	FWX-50A	5	1.40
60	140	740	8.1	FWX-60A	5	1.40
70	330	1400	7.2	FWX-70A	1	0.32
80	430	1850	8.1	FWX-80A	1	0.32
90	570	2450	9.0	FWX-90A	1	0.32
100	740	3150	10.0	FWX-100A	1	0.32
125	1130	4850	12.5	FWX-125A	1	0.32
150	1620	6950	15.7	FWX-150A	1	0.32
175	2170	9300	18.5	FWX-175A	1	0.32
200	2790	12000	22	FWX-200A	1	0.32
225	3210	14700	24	FWX-225A	1	0.52
250	3960	18100	27	FWX-250A	1	0.52
275	4720	21600	31	FWX-275A	1	0.52
300	6000	27300	32	FWX-300A	1	0.52
350	10600	48600	39	FWX-350A	1	0.52
400	14500	66100	44	FWX-400A	1	0.52
450	22100	101000	49	FWX-450A	1	0.52
500	28000	128000	54	FWX-500A	1	0.52
600	41100	188000	62	FWX-600A	1	0.52
700	48800	190000	72	FWX-700A	1	0.90
800	59000	230000	84	FWX-800A	1	0.90
1000	44000	360000	100	FWX-1000AH	1	2.86
1200	92000	750000	103	FWX-1200AH	1	2.86
1500	120000	880000	140	FWX-1500AH	1	2.86
1600	160000	1200000	140	FWX-1600AH	1	2.86
2000	320000	2300000	151	FWX-2000AH	1	2.86
2500	670000	4700000	163	FWX-2500AH	1	2.86

CE CE logo denotes compliance with European Union Low Voltage Directive (50-1000Vac, 75-1500Vdc). Refer to Data Sheet: 8002 or contact Bussmann Application Engineering at 636-527-1270 for more information.



North American Style

FWH 500V

Voltage Rating: 500Vac/500Vdc (500Vdc rating applies to 35 through 800A only.)

Interrupting Rating: 200kA RMS Symmetrical.

Agency Information: UL Recognized, Std. 248-13, 35-1200A; CSA Component Acceptance 35-1600A

Watts loss provided at rated current.



Electrical Characteristics

Ordering Information

Rated Current RMS-Amps	I ² t (A ² SEC) @ 100kA		Watts Loss	Part Number	Carton Qty.	Carton Weight (lbs)
	Pre-arc	Clearing at 500V				
35	34	150	.8	FWH-35B	10	1.34
40	76	320	7.5	FWH-40B	10	1.34
45	105	450	7.5	FWH-45B	10	1.34
50	135	670	7.5	FWH-50B	10	1.34
60	210	900	9.9	FWH-60B	10	1.34
70	210	900	10.6	FWH-70B	10	2.05
80	305	1400	12.7	FWH-80B	10	2.05
90	360	1600	15	FWH-90B	10	2.05
100	475	2000	17	FWH-100B	10	2.05
125	800	3500	25	FWH-125B	5	1.65
150	1100	4600	30	FWH-150B	5	1.65
175	1450	6200	35	FWH-175B	5	1.65
200	1900	8500	40	FWH-200B	5	1.65
225	4600	23300	39	FWH-225A	1	0.57
250	6300	32200	41	FWH-250A	1	0.57
275	7900	40300	46	FWH-275A	1	0.57
300	9800	49800	51	FWH-300A	1	0.57
325	13700	63800	53	FWH-325A	1	0.57
350	14500	72900	58	FWH-350A	1	0.57
400	19200	96700	65	FWH-400A	1	0.57
450	24700	127000	74	FWH-450A	1	1.00
500	29200	149000	84	FWH-500A	1	1.00
600	41300	206000	108	FWH-600A	1	1.00
700	55000	298000	120	FWH-700A	1	2.14
800	76200	409000	129	FWH-800A	1	2.14
1000	92000	450000	145	FWH-1000A	1	4.62
1200	122000	600000	180	FWH-1200A	1	4.62
1400	200000	1000000	210	FWH-1400A	1	11.66
1600	290000	1400000	230	FWH-1600A	1	11.66

CE CE logo denotes compliance with European Union Low Voltage Directive (50-1000Vac, 75-1500Vdc). Refer to Data Sheet: 8002 or contact Bussmann Application Engineering at 636-527-1270 for more information.



North American Style

KAC 600V

Voltage Rating: 600Vac

Interrupting Rating: 200kA

RMS Symmetrical.

Agency Information:

UL Recognized, Std. 248-13,1-600A

- For new installations, Bussmann recommends the 700V FWP series fuse. The 600V fuses are supplied as replacements only.



Ordering Information

Part Number	Carton Qty.	Carton Weight (lbs)
KAC-1	10	0.50
KAC-2	10	0.50
KAC-3	10	0.50
KAC-4	10	0.50
KAC-5	10	0.50
KAC-6	10	0.50
KAC-7	10	0.50
KAC-8	10	0.50
KAC-9	10	0.50
KAC-10	10	0.50
KAC-12	10	0.50
KAC-15	10	0.50
KAC-17.5	10	0.50
KAC-20	10	0.50
KAC-25	10	0.50
KAC-30	10	0.50
KAC-35	10	1.40
KAC-40	10	1.40
KAC-45	10	1.40
KAC-50	10	1.40
KAC-60	10	1.40
KAC-70	5	1.56
KAC-80	5	1.56
KAC-90	5	1.56
KAC-100	5	1.56
KAC-110	1	0.78
KAC-125	1	0.78
KAC-150	1	0.78
KAC-175	1	0.78
KAC-200	1	0.78
KAC-225	1	1.92
KAC-250	1	1.92
KAC-300	1	1.92
KAC-350	1	1.92
KAC-400	1	1.92
KAC-450	1	3.16
KAC-500	1	3.16
KAC-600	1	3.16
KAC-700	1	3.16
KAC-800	1	3.16
KAC-1000	1	6.24

CE CE logo denotes compliance with European Union Low Voltage Directive (50-1000Vac, 75-1500Vdc). Refer to Data Sheet: 8002 or contact Bussmann Application Engineering at 636-527-1270 for more information.

KBC 600V

Voltage Rating: 600Vac

Interrupting Rating: 200kA

RMS Symmetrical.

Agency Information:

UL Recognized, Std. 248-13,

35-600A

- For new installations, Bussmann recommends the 700 Volt FWP series fuse. The 600V fuses are supplied as replacements only.



Ordering Information

Part Number	Carton Qty.	Carton Weight (lbs)
KBC-35	10	1.40
KBC-40	10	1.40
KBC-45	10	1.40
KBC-50	10	1.40
KBC-60	10	1.40
KBC-70	5	1.44
KBC-80	5	1.44
KBC-90	5	1.44
KBC-100	5	1.44
KBC-110	1	0.48
KBC-125	1	0.48
KBC-150	1	0.48
KBC-175	1	0.48
KBC-200	1	0.48
KBC-225	1	0.77
KBC-250	1	0.77
KBC-300	1	0.77
KBC-350	1	0.77
KBC-400	1	0.77
KBC-450	1	1.32
KBC-500	1	1.32
KBC-600	1	1.32
KBC-800	1	4.50

CE CE logo denotes compliance with European Union Low Voltage Directive (50-1000Vac, 75-1500Vdc). Refer to Data Sheet: 8002 or contact Bussmann Application Engineering at 636-527-1270 for more information.



Data Sheet: 720009

Data Sheet: 720010

For complete specification data, call Bussmann Information Fax ~ 636.527.1450

North American Style

FWP 700V

Voltage Rating: 700Vac/700Vdc (700Vdc rating applies to 5 through 800A only.)

Interrupting Rating: 200kA RMS Symmetrical.

Agency Information: UL Recognized, Std. 248-13; CSA Component Acceptance

Watts loss provided at rated current.



CE CE logo denotes compliance with European Union Low Voltage Directive (50-1000Vac, 75-1500Vdc). Refer to Data Sheet: 8002 or contact Bussmann Application Engineering at 636-527-1270 for more information.

Electrical Characteristics

Ordering Information

Rated Current RMS-Amps	I ² t (A ² SEC) @ 100kA		Watts Loss	Part Number	Carton Qty.	Carton Weight (lbs)
	Pre-arc	Clearing at 700V				
5	1.6	10	1.5	FWP-5B	10	2.25
10	3.6	20	4	FWP-10B	10	2.25
15	10	75	5.5	FWP-15B	10	2.25
20	26	180	6	FWP-20B	10	2.25
25	44	340	7	FWP-25B	10	2.25
30	58	450	9	FWP-30B	10	2.25
35	34	160	12	FWP-35B	10	2.42
40	76	320	12	FWP-40B	10	2.42
50	135	600	12	FWP-50B	10	2.42
60	210	950	15.5	FWP-60B	10	2.42
70	305	1400	18	FWP-70B	10	2.42
80	360	1600	21	FWP-80B	10	2.42
90	415	1900	25	FWP-90B	10	2.42
100	540	2500	27	FWP-100B	10	2.42
125	1800	7300	28	FWP-125A	1	0.65
150	2900	11700	32	FWP-150A	1	0.65
175	4200	16700	35	FWP-175A	1	0.65
200	5500	22000	43	FWP-200A	1	0.65
225	7700	31300	45	FWP-225A	1	1.17
250	10500	42500	48	FWP-250A	1	1.17
300	17600	71200	58	FWP-300A	1	1.17
350	23700	95600	65	FWP-350A	1	1.17
400	31000	125000	78	FWP-400A	1	1.17
450	36400	137000	94	FWP-450A	1	2.39
500	45200	170000	107	FWP-500A	1	2.39
600	66700	250000	122	FWP-600A	1	2.39
700	54000	300000	125	FWP-700A	1	1.21
800	78000	450000	140	FWP-800A	1	1.21
900	91500	530000	150	FWP-900A	1	6.60
1000	120000	600000	170	FWP-1000A	1	6.60
1200	195000	1100000	190	FWP-1200A	1	6.60



North American Style

FWJ 1000V

Voltage Rating: 1000Vac/800Vdc (Ampere ratings
35-200 and 500-600 rated up to 800Vdc)

Interrupting Rating: 25kA for 35-200A,
100kA for 250-600A

Agency Information:

UL Recognition on 35 through 600A only, Std. 248-13

Watts loss provided at rated current.

CE logo denotes compliance with European Union Low Voltage Directive (50-1000Vac, 75-1500Vdc). Refer to Data Sheet: 8002 or contact Bussmann Application Engineering at 636-527-1270 for more information.



Electrical Characteristics

Ordering Information

Rated Current RMS-Amps	I ^t (A ² SEC) @ 100kA		Watts Loss	Part Number	Carton Qty.	Carton Weight (lbs)
	Pre-arc	Clearing at 1000V				
35	210	2000	7	FWJ-35A	10	4.18
40	300	2500	8	FWJ-40A	10	4.18
50	470	3500	10	FWJ-50A	10	4.18
60	670	5000	11	FWJ-60A	10	4.18
70	1100	6900	12	FWJ-70A	10	4.18
80	1550	9700	13	FWJ-80A	10	4.18
90	1900	12000	14	FWJ-90A	10	4.18
100	2800	17500	15	FWJ-100A	10	4.18
125	4800	35000	16	FWJ-125A	1	4.40
150	6300	45000	25	FWJ-150A	1	4.40
175	7500	65000	30	FWJ-175A	1	4.40
200	11700	80000	32	FWJ-200A	1	4.40
250	9000	50000	50	FWJ-250A	1	4.84
300	15000	80000	56	FWJ-300A	1	4.84
350	22000	120000	62	FWJ-350A	1	4.84
400	32000	180000	67	FWJ-400A	1	4.84
500	28500	155000	95	FWJ-500A	1	4.84
600	46500	260000	105	FWJ-600A	1	4.84
800	87000	500000	182	FWJ-800A	1	5.28
1000	190000	1100000	206	FWJ-1000A	1	5.28
1200	370000	2100000	240	FWJ-1200A	1	5.28
1400	470000	2700000	248	FWJ-1400A	1	5.28
1600	700000	4000000	267	FWJ-1600A	1	5.28
1800	925000	5300000	239	FWJ-1800A	1	5.28
2000	1330000	7600000	244	FWJ-2000A	1	5.28



North American Style Fuseblocks

Modular Style

Bussmann offers a comprehensive line of fuse bases that provide the user with design and manufacturing flexibility. Two identical half bases make up a Buss Modular fuse base. These “split” units can be panel mounted any distance apart to accommodate any length fuse.

Stud Type

The simpler design is the C5268 Series Modular fuse base. With this design, the fuse terminal and cable (with termination) are mounted on the same stud, minimizing labor needed for installation. The stud Type Base is available in the configuration shown in the table below. (Must order 2 pieces per fuse, they do not come in pairs.)

Part No.	Stud Heights	Stud Dia. & Threads
C5268-1	1.00"	5/16"-18
C5268-2	1.75"	5/16"-18
C5268-3	0.75"	5/16"-18
C5268-4	1.00"	1/4"-20
C5268-5	1.75"	1/4"-20



Connector Type

Bussmann also offers a modular style fuse base that utilizes a tin plated connector (for wire termination and heat dissipation) and a plated steel stud (for fuse mounting). The connector type fuse base is available in the configurations shown below. Consult Bussmann for additional product details. (Order 1 piece per fuse, parts come in pairs.)

Modular Base Style	Max. Voltage	Max. Fuse Current Rating
BH-0 Series	700V	100A
BH-1 Series	2500V	400A
BH-2 Series	5000V	400A
BH-3 Series	1250V	700A

See page 67.



Fixed Center Base Style

Bussmann offers a comprehensive line of fixed mount style fuse bases under the trademark TRON® Rectifier Fuseblocks. The cable and fuse connections are similar to the Stud Type fuse base — both are mounted on the same stud. Consult Bussmann for complete product details.



CE CE logo denotes compliance with European Union Low Voltage Directive (50-1000Vac, 75-1500Vdc). Refer to Data Sheet: 8002 or contact Bussmann Application Engineering at 636-527-1270 for more information.



European Style Square Body—General Information



Voltage Rating

690Vac	10 to 7500A
1250Vac	50 to 1400A

All Bussmann European Style fuses are tested to IEC 60269, Part 4. This standard requires a test voltage which is 10% higher than the rated voltage. In North America, fuses are required to clear only their rated voltage.

Characteristics

Designed and tested to:

- IEC 60269: Part 4
- UL Recognized
- Minimal energy let-thru (I^2t)
- Low operating temperature
- Low Watts loss

General Information

Each European Style fuse is available with a number of different end fittings. Options include:

- DIN 43 653
- North American Slotted Blade
- DIN 43 620
- Flush End (Metric/U.S.)
- French Style

Accessories

European Style fuses are available with three different open fuse indicator systems. Options include visual indication and indication utilizing a microswitch. Fuseblocks are also available for most applications.



European Style Square Body

DIN 43 653—10-400A

Voltage Rating: 690V (IEC) & 700V (UL)

Interrupting Rating: 200kA (estimated 300kA) RMS Symmetrical

Agency Information:

UL Recognized, Std. 248-13

CSA Component Acceptance on Size 000

Watts loss provided at rated current.

Microswitch indicator ordered separately.

See bottom of page 146.

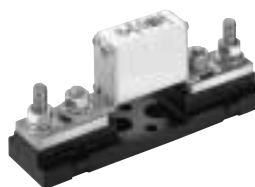

CE CE logo denotes compliance with European Union Low Voltage Directive (50-1000Vac, 75-1500Vdc). Refer to Data Sheet: 8002 or contact Bussmann Application Engineering at 636-527-1270 for more information.

Electrical Characteristics

Ordering Information

Size	Rated Current RMS-Amps	I ² t (A²s)		Watts Loss	Ordering Information			Carton Qty.	Carton Weight (Kg)
		Pre-arc	Clearing at 660V		-U/80 Without Indicator	-/80 Visual Indicator	-TN/80 Type T Indicator for Micro		
000	10	3.8	25.5	3.0	170M1308*	170M1358*	170M1408*	10	1.34
	16	7.2	48	5.5	170M1309*	170M1359*	170M1409*	10	1.34
	20	11.5	78	7	170M1310*	170M1360*	170M1410*	10	1.34
	25	19	130	9	170M1311*	170M1361*	170M1411*	10	1.34
	32	40	270	10	170M1312*	170M1362*	170M1412*	10	1.34
	40	69	460	12	170M1313*	170M1363*	170M1413*	10	1.34
	50	115	770	15	170M1314*	170M1364*	170M1414*	10	1.34
	63	215	1450	16	170M1315*	170M1365*	170M1415*	10	1.34
	80	380	2550	19	170M1316*	170M1366*	170M1416*	10	1.34
	100	695	4650	24	170M1317*	170M1367*	170M1417*	10	1.34
	125	1200	8500	28	170M1318*	170M1368*	170M1418*	10	1.34
	160	2300	16000	32	170M1319*	170M1369*	170M1419*	10	1.34
	200	4200	28000	37	170M1320*	170M1370*	170M1420*	10	1.34
	250	7750	51500	42	170M1321*	170M1371*	170M1421*	10	1.34
	315	12000	80500	52	170M1322*	170M1372*	170M1422*	10	1.34
	00	25	19	130	6	—	170M2608	170M2658	5
32		28.5	195	7	—	170M2609	170M2659	5	1.05
40		50	360	9	—	170M2610	170M2660	5	1.05
50		95	640	10	—	170M2611	170M2661	5	1.05
63		170	1200	12	—	170M2612	170M2662	5	1.05
80		310	2100	15	—	170M2613	170M2663	5	1.05
100		620	4150	20	—	170M2614	170M2664	5	1.05
125		1000	6950	25	—	170M2615	170M2665	5	1.05
160		1900	13000	30	—	170M2616	170M2666	5	1.05
200		3400	23000	35	—	170M2617	170M2667	5	1.05
250		6250	42000	45	—	170M2618	170M2668	5	1.05
315		10000	68500	55	—	170M2619	170M2669	5	1.05
350		13500	91500	60	—	170M2620	170M2670	5	1.05
400	18000	125000	70	—	170M2621	170M2671	5	1.05	

*UL Recognized / CSA Component Accepted on size 000.



European Style Square Body

DIN 43 653—40-2000A

Voltage Rating: 690V (IEC) & 700V (UL)

Interrupting Rating: 200kA (estimated 300kA) RMS Symmetrical

Agency Information: CSA Component Acceptance

UL Recognized, Std. 248-13 

Watts loss provided at rated current.

Microswitch indicator ordered separately. See bottom of page 146.



Electrical Characteristics

Ordering Information

Size	Rated Current RMS-Amps	I ² t (A ² s)		Watts Loss	-TN/80 Type T Indicator for Micro		-TN/110 Type T Indicator for Micro		Carton Qty.	Carton Weight (Kg)
		Pre-arc	Clearing at 660V		-/80 Visual Indicator	-/110 Visual Indicator				
1*	40	40	270	9	170M3008*	170M3058*	170M3158*	170M3208*	5	1.50
	50	77	515	11	170M3009*	170M3059*	170M3159*	170M3209*	5	1.50
	63	115	770	14	170M3010*	170M3060*	170M3160*	170M3210*	5	1.50
	80	185	1250	18	170M3011*	170M3061*	170M3161*	170M3211*	5	1.50
	100	360	2450	21	170M3012*	170M3062*	170M3162*	170M3212*	5	1.50
	125	550	3700	26	170M3013*	170M3063*	170M3163*	170M3213*	5	1.50
	160	1100	7500	30	170M3014*	170M3064*	170M3164*	170M3214*	5	1.50
	200	2200	15000	35	170M3015*	170M3065*	170M3165*	170M3215*	5	1.50
	250	4200	28500	40	170M3016*	170M3066*	170M3166*	170M3216*	5	1.50
	315	7000	46500	50	170M3017*	170M3067*	170M3167*	170M3217*	5	1.50
	350	10000	68500	55	170M3018*	170M3068*	170M3168*	170M3218*	5	1.50
	400	15000	105000	60	170M3019*	170M3069*	170M3169*	170M3219*	5	1.50
	450	21000	140000	65	170M3020*	170M3070*	170M3170*	170M3220*	5	1.50
	500	27000	180000	70	170M3021*	170M3071*	170M3171*	170M3221*	5	1.50
	550	34000	230000	75	170M3022*	170M3072*	170M3172*	170M3222*	5	1.50
	630	48500	325000	80	170M3023*	170M3073*	170M3173*	170M3223*	5	1.50
1	200	1650	11500	45	170M4008*	170M4058*	170M4158*	170M4208*	3	1.29
	250	3100	21000	55	170M4009*	170M4059*	170M4159*	170M4209*	(-/80)	—
	315	6200	42000	58	170M4010*	170M4060*	170M4160*	170M4210*	—	—
	350	8500	59000	60	170M4011*	170M4061*	170M4161*	170M4211*	2	0.94
	400	13500	91500	65	170M4012*	170M4062*	170M4162*	170M4212*	(-/110)	—
	450	17000	120000	70	170M4013*	170M4063*	170M4163*	170M4213*	—	—
	500	25000	170000	72	170M4014*	170M4064*	170M4164*	170M4214*	—	—
	550	34000	230000	75	170M4015*	170M4065*	170M4165*	170M4215*	—	—
	630	52000	350000	80	170M4016*	170M4066*	170M4166*	170M4216*	—	—
	700	69500	465000	85	170M4017*	170M4067*	170M4167*	170M4217*	—	—
2	800	105000	725000	95	170M4018*	170M4068*	170M4168*	170M4218*	—	—
	†900	155000	†850000	100	170M4019	170M4069	170M4169	170M4219	—	—
	400	11000	74000	65	170M5008*	170M5058*	170M5158*	170M5208*	2	1.20
	450	15500	105000	70	170M5009*	170M5059*	170M5159*	170M5209*	2	1.20
	500	21500	145000	75	170M5010*	170M5060*	170M5160*	170M5210*	2	1.20
	550	28000	190000	80	170M5011*	170M5061*	170M5161*	170M5211*	2	1.20
	630	41000	275000	90	170M5012*	170M5062*	170M5162*	170M5212*	2	1.20
	700	60500	405000	95	170M5013*	170M5063*	170M5163*	170M5213*	2	1.20
	800	86000	575000	105	170M5014*	170M5064*	170M5164*	170M5214*	2	1.20
	900	125000	840000	110	170M5015*	170M5065*	170M5165*	170M5215*	2	1.20
	1000	180000	1250000	115	170M5016*	170M5066*	170M5166*	170M5216*	2	1.20
	1100	245000	1600000	120	170M5017*	170M5067*	170M5167*	170M5217*	2	1.20
3	1250	365000	2400000	130	170M5018*	170M5068*	170M5168*	170M5218*	2	1.20
	500	14000	95000	95	170M6008*	170M6058*	170M6158*	170M6208*	2	1.66
	550	19500	135000	100	170M6009*	170M6059*	170M6159*	170M6209*	(-/80)	—
	630	31000	210000	105	170M6010*	170M6060*	170M6160*	170M6210*	—	—
	700	44500	300000	110	170M6011*	170M6061*	170M6161*	170M6211*	1	0.89
	800	69500	465000	115	170M6012*	170M6062*	170M6162*	170M6212*	(-/110)	—
	900	100000	670000	120	170M6013*	170M6063*	170M6163*	170M6213*	—	—
	1000	140000	945000	125	170M6014*	170M6064*	170M6164*	170M6214*	—	—
	1100	190000	1300000	130	170M6015*	170M6065*	170M6165*	170M6215*	—	—
	1250	290000	1950000	140	170M6016*	170M6066*	170M6166*	170M6216*	—	—
	1400	370000	2450000	155	170M6017*	170M6067*	170M6167*	170M6217*	—	—
	1500	460000	3100000	160	170M6018*	170M6068*	170M6168*	170M6218*	—	—
1600	580000	3900000	160	170M6019*	170M6069*	170M6169	170M6219	—	—	
†1800	880000	†5250000	165	170M6020	170M6070	170M6170	170M6220	—	—	
†2000	1150000	†6350000	175	170M6021	170M6071	170M6171	170M6221	—	—	

*UL Recognized / CSA Component Accepted. Rated voltage †600V †550V



European Style Square Body

DIN 43 653—40-2000A

Voltage Rating: 690V (IEC) & 700V (UL)

Interrupting Rating: 200kA (estimated 300kA) RMS Symmetrical

Agency Information: CSA Component Acceptance

UL Recognized, Std. 248-13 **CE**

Watts loss provided at rated current.

Microswitch indicator ordered separately. See bottom of page 146.



Electrical Characteristics

Ordering Information

Size	Rated Current RMS-Amps	I _t (A·s)		Watts Loss	-KN/80 Type K Indicator for Micro	-KN/110 Type K Indicator for Micro	Carton Qty.	Carton Weight (Kg)
		Pre-arc	Clearing at 660V					
1*	40	40	270	9	170M3108*	170M3258*	5	1.60
	50	77	515	11	170M3109*	170M3259*	5	1.60
	63	115	770	14	170M3110*	170M3260*	5	1.60
	80	185	1250	18	170M3111*	170M3261*	5	1.60
	100	360	2450	21	170M3112*	170M3262*	5	1.60
	125	550	3700	26	170M3113*	170M3263*	5	1.60
	160	1100	7500	30	170M3114*	170M3264*	5	1.60
	200	2200	15000	35	170M3115*	170M3265*	5	1.60
	250	4200	28500	40	170M3116*	170M3266*	5	1.60
	315	7000	46500	50	170M3117*	170M3267*	5	1.60
	350	10000	68500	55	170M3118*	170M3268*	5	1.60
	400	15000	105000	60	170M3119*	170M3269*	5	1.60
	450	21000	140000	65	170M3120*	170M3270*	5	1.60
	500	27000	180000	70	170M3121*	170M3271*	5	1.60
	550	34000	230000	75	170M3122*	170M3272*	5	1.60
	630	48500	325000	80	170M3123*	170M3273*	5	1.60
	1	200	1650	11500	45	170M4108*	170M4258*	3
250		3100	21000	55	170M4109*	170M4259*	(-/80)	—
315		6200	42000	58	170M4110*	170M4260*	—	—
350		8500	59000	60	170M4111*	170M4261*	2	1.00
400		13500	91500	65	170M4112*	170M4262*	(-/110)	—
450		17000	120000	70	170M4113*	170M4263*	—	—
500		25000	170000	72	170M4114*	170M4264*	—	—
550		34000	230000	75	170M4115*	170M4265*	—	—
630		52000	350000	80	170M4116*	170M4266*	—	—
700		69500	465000	85	170M4117*	170M4267*	—	—
800		105000	725000	95	170M4118*	170M4268*	—	—
2	±900	155000	±850000	100	170M4119	170M4269	—	—
	400	11000	74000	65	170M5108*	170M5258*	2	1.26
	450	15500	105000	70	170M5109*	170M5259*	2	1.26
	500	21500	145000	75	170M5110*	170M5260*	2	1.26
	550	28000	190000	80	170M5111*	170M5261*	2	1.26
	630	41000	275000	90	170M5112*	170M5262*	2	1.26
	700	60500	405000	95	170M5113*	170M5263*	2	1.26
	800	86000	575000	105	170M5114*	170M5264*	2	1.26
	900	125000	840000	110	170M5115*	170M5265*	2	1.26
	1000	180000	1250000	115	170M5116*	170M5266*	2	1.26
	1100	245000	1600000	120	170M5117*	170M5267*	2	1.26
	1250	365000	2400000	130	170M5118*	170M5268*	2	1.26
	3	500	14000	95000	95	170M6108*	170M6258*	1
550		19500	135000	100	170M6109*	170M6259*	1	0.92
630		31000	210000	105	170M6110*	170M6260*	1	0.92
700		44500	300000	110	170M6111*	170M6261*	1	0.92
800		69500	465000	115	170M6112*	170M6262*	1	0.92
900		100000	670000	120	170M6113*	170M6263*	1	0.92
1000		140000	945000	125	170M6114*	170M6264*	1	0.92
1100		190000	1300000	130	170M6115*	170M6265*	1	0.92
1250		290000	1950000	140	170M6116*	170M6266*	1	0.92
1400		370000	2450000	155	170M6117*	170M6267*	1	0.92
1500		460000	3100000	160	170M6118*	170M6268*	1	0.92
1600		580000	3900000	160	170M6119*	170M6269*	1	0.92
±1800		880000	±5250000	165	170M6120	170M6270	1	0.92
±2000	1150000	±6350000	175	170M6121	170M6271	1	0.92	

*UL Recognized / CSA Component Accepted.

Rated voltage †600V †550V



European Style Square Body

DIN 43 653—50-1400A

Voltage Rating: 1250V (IEC)/1300V (UL)

Interrupting Rating: 100kA RMS Symmetrical

Agency Information: CSA Component Acceptance

UL Recognized, Std. 248-13 **CE**

Watts loss provided at rated current.

Microswitch indicator ordered separately. See bottom of page 146.



Electrical Characteristics

Ordering Information

Size	Rated Current RMS-Amps	I _t (A ² s)			Watts Loss	-/110 Visual Indicator	-TN/110 Type T Indicator for Micro	Carton Qty.	Carton Weight (Kg)
		Pre-arc	Clearing at 1000V	Clearing at 1250V					
1*	50	135	815	1100	15	170M3138*	170M3188*	5	1.90
	63	215	1300	1750	20	170M3139*	170M3189*	5	1.90
	80	420	2500	3350	25	170M3140*	170M3190*	5	1.90
	100	750	4450	5950	30	170M3141*	170M3191*	5	1.90
	125	1450	9000	11500	35	170M3142*	170M3192*	5	1.90
	160	2600	16000	21000	40	170M3143*	170M3193*	5	1.90
	200	5150	31000	41000	45	170M3144*	170M3194*	5	1.90
	250	9200	54500	73000	55	170M3145*	170M3195*	5	1.90
	315	18500	115000	150000	60	170M3146*	170M3196*	5	1.90
	350	27000	165000	220000	65	170M3147*	170M3197*	5	1.90
	400	53000	265000	335000	70	170M3148*	170M3198*	5	1.90
	1	160	1900	11500	15500	45	170M4138*	170M4188*	2
200		3800	22500	30000	50	170M4139*	170M4189*	2	1.18
250		7750	46000	61500	60	170M4140*	170M4190*	2	1.18
315		15000	90000	120000	65	170M4141*	170M4191*	2	1.18
350		20000	125000	165000	70	170M4142*	170M4192*	2	1.18
400		29500	175000	235000	75	170M4143*	170M4193*	2	1.18
450		42000	250000	335000	80	170M4144*	170M4194*	2	1.18
500		69500	340000	435000	85	170M4145*	170M4195*	2	1.18
550		95000	465000	590000	95	170M4146*	170M4196*	2	1.18
†630		130000	660000	—	100	170M4147	170M4197	2	1.18
2	250	6500	38500	51500	65	170M5138*	170M5188*	2	1.58
	280	9350	55500	74500	70	170M5139*	170M5189*	2	1.58
	315	13000	77500	105000	75	170M5140*	170M5190*	2	1.58
	350	16500	97500	135000	80	170M5141*	170M5191*	2	1.58
	400	23000	140000	180000	85	170M5142*	170M5192*	2	1.58
	450	34000	205000	270000	90	170M5143*	170M5193*	2	1.58
	500	48000	285000	380000	95	170M5144*	170M5194*	2	1.58
	550	62000	370000	495000	100	170M5145*	170M5195*	2	1.58
	630	115000	575000	730000	110	170M5146*	170M5196*	2	1.58
	700	160000	795000	1050000	115	170M5147*	170M5197*	2	1.58
	800	245000	1200000	1550000	120	170M5148*	170M5198*	2	1.58
	†900	360000	1750000	—	125	170M5149	170M5199	2	1.58
	†1000	480000	2350000	—	135	170M5150	170M5200	2	1.58
3	315	9500	58000	77500	85	170M6138*	170M6188*	1	1.23
	350	13500	81500	110000	90	170M6139*	170M6189*	1	1.23
	400	19500	120000	160000	95	170M6140*	170M6190*	1	1.23
	450	31000	185000	245000	100	170M6141*	170M6191*	1	1.23
	500	39000	235000	310000	105	170M6142*	170M6192*	1	1.23
	550	55000	325000	435000	110	170M6143*	170M6193*	1	1.23
	630	83500	495000	665000	115	170M6144*	170M6194*	1	1.23
	700	115000	705000	940000	120	170M6145*	170M6195*	1	1.23
	†800	205000	995000	1300000	125	170M6146	170M6196*	1	1.23
	†900	305000	1500000	1900000	130	170M6147	170M6197*	1	1.23
	†1000	450000	2150000	2750000	135	170M6148	170M6198*	1	1.23
	†1100	575000	2800000	3600000	140	170M6149	170M6199*	1	1.23
	†1250	810000	†3950000	—	145	170M6150	170M6200	1	1.23
	†1400	1250000	†6000000	—	150	170M6151	170M6201	1	1.23

*UL Recognized / CSA Component Accepted. Rated voltage †1100V ‡1250V



European Style Square Body

DIN 43 653—50-1400A

Voltage Rating: 1250V (IEC)/1300V (UL)

Interrupting Rating: 100kA RMS Symmetrical

Agency Information: CSA Component Acceptance

UL Recognized, Std. 248-13 **CE**

Watts loss provided at rated current.

Microswitch indicator ordered separately. See bottom of page 146.



Electrical Characteristics

Ordering Information

Size	Rated Current RMS-Amps	I _t (A·s)			Watts Loss	-KN/110 Type K Indicator for Micro	Carton Qty.	Carton Weight (Kg)	
		Pre-arc	Clearing at 1000V	Clearing at 1250V					
1*	50	135	815	1100	15	170M3238*	2	0.84	
	63	215	1300	1750	20	170M3239*	2	0.84	
	80	420	2500	3350	25	170M3240*	2	0.84	
	100	750	4450	5950	30	170M3241*	2	0.84	
	125	1450	9000	11500	35	170M3242*	2	0.84	
	160	2600	16000	21000	40	170M3243*	2	0.84	
	200	5150	31000	41000	45	170M3244*	2	0.84	
	250	9200	54500	73000	55	170M3245*	2	0.84	
	315	18500	115000	150000	60	170M3246*	2	0.84	
	350	27000	165000	220000	65	170M3247*	2	0.84	
	400	53000	265000	335000	70	170M3248*	2	0.84	
	1	160	1900	11500	15500	45	170M4238*	2	1.26
		200	3800	22500	30000	50	170M4239*	2	1.26
250		7750	46000	61500	60	170M4240*	2	1.26	
315		15000	90000	120000	65	170M4241*	2	1.26	
350		20000	125000	165000	70	170M4242*	2	1.26	
400		29500	175000	235000	75	170M4243*	2	1.26	
450		42000	250000	335000	80	170M4244*	2	1.26	
500		69500	340000	435000	85	170M4245*	2	1.26	
550		95000	465000	590000	95	170M4246*	2	1.26	
†630		130000	660000	—	100	170M4247	2	1.26	
2		250	6500	38500	51500	65	170M5238*	2	1.66
	280	9350	55500	74500	70	170M5239*	2	1.66	
	315	13000	77500	105000	75	170M5240*	2	1.66	
	350	16500	97500	135000	80	170M5241*	2	1.66	
	400	23000	140000	180000	85	170M5242*	2	1.66	
	450	34000	205000	270000	90	170M5243*	2	1.66	
	500	48000	285000	380000	95	170M5244*	2	1.66	
	550	62000	370000	495000	100	170M5245*	2	1.66	
	630	115000	575000	730000	110	170M5246*	2	1.66	
	700	160000	795000	1050000	115	170M5247*	2	1.66	
	800	245000	1200000	1550000	120	170M5248*	2	1.66	
	†900	360000	1750000	—	125	170M5249	2	1.66	
	†1000	480000	2350000	—	135	170M5250	2	1.66	
3	315	9500	58000	77500	85	170M6238*	1	1.27	
	350	13500	81500	110000	90	170M6239*	1	1.27	
	400	19500	120000	160000	95	170M6240*	1	1.27	
	450	31000	185000	245000	100	170M6241*	1	1.27	
	500	39000	235000	310000	105	170M6242*	1	1.27	
	550	55000	325000	435000	110	170M6243*	1	1.27	
	630	83500	495000	665000	115	170M6244*	1	1.27	
	700	115000	705000	940000	120	170M6245*	1	1.27	
	†800	205000	995000	1300000	125	170M6246	1	1.27	
	†900	305000	1500000	1900000	130	170M6247	1	1.27	
	†1000	450000	2150000	2750000	135	170M6248	1	1.27	
	†1100	575000	2800000	3600000	140	170M6249	1	1.27	
	†1250	810000	†3950000	—	145	170M6250	1	1.27	
†1400	1250000	†6000000	—	150	170M6251	1	1.27		

*UL Recognized / CSA Component Accepted. Rated voltage †1100V ‡1250V



European Style Square Body

DIN 43 620—10-315A

Voltage Rating: 690V (IEC/UL)

Interrupting Rating: 200kA (estimated 300kA) RMS Symmetrical

Agency Information:

UL Recognized, Std. 248-13

Rated Current: The rated current of this fuse range has been given with copper conductors that have a current density of 1.3 A/mm² (IEC 60269-4). For conductor cross section according to IEC 60269-1, the fuses with a rated current higher than 125A must be derated. Please contact Bussmann for application assistance.

Watts loss provided at rated current.

Microswitch indicator ordered separately.

See bottom of page 146.



CE CE logo denotes compliance with European Union Low Voltage Directive (50-1000Vac, 75-1500Vdc). Refer to Data Sheet: 8002 or contact Bussmann Application Engineering at 636-527-1270 for more information.

Electrical Characteristics

Ordering Information

Size	Rated Current RMS-Amps	I ² t (A ² s)		Watts Loss	DIN 000 Type T Indicator for Micro	Carton Qty.	Carton Weight (Kg)
		Pre-arc	Clearing at 660V				
	10	3.8	25.5	3.0	170M1558*	10	1.30
	16	7.2	48	5.5	170M1559*	10	1.30
	20	11.5	78	7	170M1560*	10	1.30
	25	19	130	9	170M1561*	10	1.30
	32	40	270	10	170M1562*	10	1.30
	40	69	460	12	170M1563*	10	1.30
000	50	115	770	15	170M1564*	10	1.30
	63	215	1450	16	170M1565*	10	1.30
	80	380	2550	19	170M1566*	10	1.30
	100	695	4650	24	170M1567*	10	1.30
	125	1200	8500	28	170M1568*	10	1.30
	160	2300	16000	32	170M1569*	10	1.30
	200	4200	28000	37	170M1570*	10	1.30
	250	7750	51500	42	170M1571*	10	1.30
	315	12000	80500	52	170M1572*	10	1.30

*UL Recognized



European Style Square Body

DIN 43 620—40-1000A

Voltage Rating: 690V (IEC)/700V (UL)

Interrupting Rating: 200kA (estimated 300kA) RMS Symmetrical

Agency Information:

UL Recognized, Std. 248-13

Rated Current: The rated current of this fuse range has been given with copper conductors that have a current density of 1.3 A/mm² (IEC 60269-4). For conductor cross section according to IEC 60269-1, the fuses with a rated current higher than 125A must be derated. Please contact Bussmann for application assistance.

Watts loss provided at rated current.

Microswitch indicator ordered separately.

See bottom of page 146.

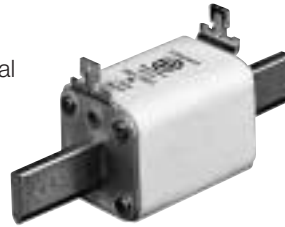

CE CE logo denotes compliance with European Union Low Voltage Directive (50-1000Vac, 75-1500Vdc). Refer to Data Sheet: 8002 or contact Bussmann Application Engineering at 636-527-1270 for more information.

Electrical Characteristics

Ordering Information

Size	Rated Current RMS-Amps	I _t (A ² s)		Watts Loss	DIN Type T Indicator for Micro	Carton Qty.	Carton Weight (Kg)
		Pre-arc	Clearing at 660V				
1*	40	40	270	9	170M3808*	5	1.85
	50	77	515	11	170M3809*	5	1.85
	63	115	770	14	170M3810*	5	1.85
	80	185	1250	18	170M3811*	5	1.85
	100	360	2450	21	170M3812*	5	1.85
	125	550	3700	26	170M3813*	5	1.85
	160	1100	7500	30	170M3814*	5	1.85
	200	2200	15000	35	170M3815*	5	1.85
	250	4200	28500	40	170M3816*	5	1.85
	315	7000	46500	50	170M3817*	5	1.85
2	350	10000	68500	55	170M3818*	5	1.85
	400	15000	105000	60	170M3819*	5	1.85
	400	11000	74000	65	170M5808*	5	3.00
	450	15500	105000	70	170M5809*	5	3.00
	500	21500	145000	75	170M5810*	5	3.00
	550	28000	190000	80	170M5811*	5	3.00
	630	41000	275000	90	170M5812*	5	3.00
3	700	60500	405000	95	170M5813*	5	3.00
	500	14000	95000	95	170M6808*	1	1.15
	550	19500	135000	100	170M6809*	1	1.15
	630	31000	210000	105	170M6810*	1	1.15
	700	44500	300000	110	170M6811*	1	1.15
	800	69500	465000	115	170M6812*	1	1.15
	900	100000	670000	120	170M6813*	1	1.15
1000	140000	945000	125	170M6814*	1	1.15	

*UL Recognized



European Style Square Body

Flush End Contact 25-400A

Voltage Rating: 690V (IEC)

Interrupting Rating: 200kA (estimated 300kA) RMS Symmetrical

Watts loss provided at rated current.

Microswitch indicator ordered separately.

See bottom of page 146.



CE CE logo denotes compliance with European Union Low Voltage Directive (50-1000Vac, 75-1500Vdc). Refer to Data Sheet: 8002 or contact Bussmann Application Engineering at 636-527-1270 for more information.

Electrical Characteristics

Ordering Information

Size	Rated Current RMS-Amps	I ² t (A ² s)		Watts Loss	00B/60 Visual Indicator	00BTN/60 Type T Indicator for Microswitch	Carton Qty.	Carton Weight (Kg)
		Pre-arc	Clearing at 660V					
00	25	19	130	6	170M2708	170M2758	5	1.35
	32	28.5	195	7	170M2709	170M2759	5	1.35
	40	50	360	9	170M2710	170M2760	5	1.35
	50	95	640	10	170M2711	170M2761	5	1.35
	63	170	1200	12	170M2712	170M2762	5	1.35
	80	310	2100	15	170M2713	170M2763	5	1.35
	100	620	4150	20	170M2714	170M2764	5	1.35
	125	1000	6950	25	170M2715	170M2765	5	1.35
	160	1900	13000	30	170M2716	170M2766	5	1.35
	200	3400	23000	35	170M2717	170M2767	5	1.35
	250	6250	42000	45	170M2718	170M2768	5	1.35
	315	10000	68500	55	170M2719	170M2769	5	1.35
	350	13500	91500	60	170M2720	170M2770	5	1.35
	400	18000	125000	70	170M2721	170M2771	5	1.35



European Style Square Body

Flush End Contact 40-2000A

Voltage Rating: 690V (IEC) 700V (UL)

Interrupting Rating: 200kA (estimated 300kA) RMS Symmetrical

Agency Information: CSA Component Acceptance

UL Recognized, Std. 248-13 

Watts loss provided at rated current.

Microswitch indicator ordered separately. See bottom of page 146.



Electrical Characteristics

Ordering Information

Size	Rated Current RMS-Amps	I ² t (A ² s)		Watts Loss	-B/- Visual Indicator	-BKN/- Type K Indicator for Micro	-G/- Visual Indicator	-GKN/- Type K Indicator for Micro	Carton Qty.	Carton Weight (Kg)
		Pre-arc	Clearing at 660V							
1*	40	40	270	9	170M3408*	170M3458*	170M3508*	170M3558*	10	2.40
	50	77	515	11	170M3409*	170M3459*	170M3509*	170M3559*	(-B/-)	—
	63	115	770	14	170M3410*	170M3460*	170M3510*	170M3560*	—	—
	80	185	1250	18	170M3411*	170M3461*	170M3511*	170M3561*	10	2.40
	100	360	2450	21	170M3412*	170M3462*	170M3512*	170M3562*	(-G/-)	—
	125	550	3700	26	170M3413*	170M3463*	170M3513*	170M3563*	—	—
	160	1100	7500	30	170M3414*	170M3464*	170M3514*	170M3564*	6	1.62
	200	2200	15000	35	170M3415*	170M3465*	170M3515*	170M3565*	(-BKN/-)	—
	250	4200	28500	40	170M3416*	170M3466*	170M3516*	170M3566*	—	—
	315	7000	46500	50	170M3417*	170M3467*	170M3517*	170M3567*	—	—
	350	10000	68500	55	170M3418*	170M3468*	170M3518*	170M3568*	6	1.62
	400	15000	105000	60	170M3419*	170M3469*	170M3519*	170M3569*	(-GKN/-)	—
	450	21000	140000	65	170M3420*	170M3470*	170M3520*	170M3570*	—	—
	500	27000	180000	70	170M3421*	170M3471*	170M3521*	170M3571*	—	—
	550	34000	230000	75	170M3422*	170M3472*	170M3522*	170M3572*	—	—
630	48500	325000	80	170M3423*	170M3473*	170M3523*	170M3573*	—	—	
1	200	1650	11500	45	170M4408*	170M4458*	170M4508*	170M4558*	6	2.40
	250	3100	21000	55	170M4409*	170M4459*	170M4509*	170M4559*	6	2.40
	315	6200	42000	58	170M4410*	170M4460*	170M4510*	170M4560*	6	2.40
	350	8500	59000	60	170M4411*	170M4461*	170M4511*	170M4561*	6	2.40
	400	13500	91500	65	170M4412*	170M4462*	170M4512*	170M4562*	6	2.40
	450	17000	120000	70	170M4413*	170M4463*	170M4513*	170M4563*	6	2.40
	500	25000	170000	72	170M4414*	170M4464*	170M4514*	170M4564*	6	2.40
	550	34000	230000	75	170M4415*	170M4465*	170M4515*	170M4565*	6	2.40
	630	52000	350000	80	170M4416*	170M4466*	170M4516*	170M4566*	6	2.40
	700	69500	465000	85	170M4417*	170M4467*	170M4517*	170M4567*	6	2.40
800	105000	725000	95	170M4418*	170M4468*	170M4518*	170M4568*	6	2.40	
†900	155000	†850000	100	170M4419	170M4469	170M4519	170M4569	6	2.40	
2	400	11000	74000	65	170M5408*	170M5458*	170M5508*	170M5558*	6	3.30
	450	15500	105000	70	170M5409*	170M5459*	170M5509*	170M5559*	6	3.30
	500	21500	145000	75	170M5410*	170M5460*	170M5510*	170M5560*	6	3.30
	550	28000	190000	80	170M5411*	170M5461*	170M5511*	170M5561*	6	3.30
	630	41000	275000	90	170M5412*	170M5462*	170M5512*	170M5562*	6	3.30
	700	60500	405000	95	170M5413*	170M5463*	170M5513*	170M5563*	6	3.30
	800	86000	575000	105	170M5414*	170M5464*	170M5514*	170M5564*	6	3.30
	900	125000	840000	110	170M5415*	170M5465*	170M5515*	170M5565*	6	3.30
	1000	180000	1250000	115	170M5416*	170M5466*	170M5516*	170M5566*	6	3.30
	1100	245000	1600000	120	170M5417*	170M5467*	170M5517*	170M5567*	4	2.40
1250	365000	2400000	130	170M5418*	170M5468*	170M5518*	170M5568*	4	2.40	
3	500	14000	95000	95	170M6408*	170M6458*	170M6508*	170M6558*	3	2.52
	550	19500	135000	100	170M6409*	170M6459*	170M6509*	170M6559*	3	2.52
	630	31000	210000	105	170M6410*	170M6460*	170M6510*	170M6560*	3	2.52
	700	44500	300000	110	170M6411*	170M6461*	170M6511*	170M6561*	3	2.52
	800	69500	465000	115	170M6412*	170M6462*	170M6512*	170M6562*	3	2.52
	900	100000	670000	120	170M6413*	170M6463*	170M6513*	170M6563*	3	2.52
	1000	140000	945000	125	170M6414*	170M6464*	170M6514*	170M6564*	3	2.52
	1100	190000	1300000	130	170M6415*	170M6465*	170M6515*	170M6565*	3	2.52
	1250	290000	1950000	140	170M6416*	170M6466*	170M6516*	170M6566*	3	2.52
	1400	370000	2450000	155	170M6417*	170M6467*	170M6517*	170M6567*	3	2.52
1500	460000	3100000	160	170M6418*	170M6468*	170M6518*	170M6568*	3	2.52	
1600	580000	3900000	160	170M6419*	170M6469*	170M6519*	170M6569*	2	1.82	
†1800	880000	†5250000	165	170M6420	170M6470	170M6520	170M6570	2	1.82	
‡2000	1150000	‡6350000	175	170M6421	170M6471	170M6521	170M6571	2	1.82	

*UL Recognized / CSA Component Accepted.

Rated voltage †600V ‡550V



European Style Square Body

Flush End Contact —1000-4000A

Voltage Rating: 690V (IEC)

Interrupting Rating: 200kA (estimated 300kA) RMS Symmetrical

Agency Information: UL Recognized, Std. 248-13

Watts loss provided at rated current.

Microswitch indicator ordered separately.

See bottom of page 146.



CE CE logo denotes compliance with European Union Low Voltage Directive (50-1000Vac, 75-1500Vdc). Refer to Data Sheet: 8002 or contact Bussmann Application Engineering at 636-527-1270 for more information.

Electrical Characteristics

Ordering Information

Size	Rated Current RMS-Norm Cool.	Rated Current RMS-Liquid Cool.	I ² t (A ² s)		Watts Loss Norm. Cool.	Watts Loss Liquid Cool.	-B/- Visual Indicator	-BKN/- Type K Indicator for Micro	-G/- Visual Indicator	-GKN/- Type K Indicator for Micro	Carton Qty.	Carton Weight (Kg)
			Pre-arc	Clearing at 660V								
4	1000	1350	76000	505000	175	315	170M7058	170M7078	170M7098	170M7118	2	1.80
	1250	1700	145000	965000	195	355	170M7059	170M7079	170M7099	170M7119	2	1.80
	1400	1900	205000	1400000	205	375	170M7060	170M7080	170M7100	170M7120	2	1.80
	1600	2200	305000	2050000	220	405	170M7061	170M7081	170M7101	170M7121	2	1.80
	2000	2700	600000	3950000	245	445	170M7062	170M7082	170M7102	170M7122	2	1.80
	2500	3400	1200000	7800000	275	495	170M7063	170M7083	170M7103	170M7123	2	1.80
	3000	4100	2000000	13500000	305	555	170M7064	170M7084	170M7104	170M7124	2	1.80
	3500	4700	3250000	22000000	325	585	170M7065	170M7085	170M7105	170M7125	2	1.80
	†4000	†5400	4700000	†28000000	355	640	170M7066	170M7086	170M7106	170M7126	2	1.80

Rated voltage †500V.

Liq. Cool. - Liquid cooling. Temperature on the terminals not to exceed 60°C.



European Style Square Body

Flush End Contact—50-1400A

Voltage Rating: 1250V (IEC) 1300V (UL)

Interrupting Rating: 100kA RMS Symmetrical

Agency Information: CSA Component Acceptance

UL Recognized, Std. 248-13 **CE**

Watts loss provided at rated current.

Microswitch indicator ordered separately. See bottom of page 146.



Electrical Characteristics

Ordering Information

Size	Rated Current RMS-Amps	I _t (A ² s)			Watts Loss	-BKN/75	-BKN/80	-BKN/90	-GKN/75	-GKN/90	
		Pre-arc	Clearing at 1000V	Clearing at 1250V		Type K Indicator for Micro	Type K Indicator for Micro	Type K Indicator for Micro	Type K Indicator for Micro	Type K Indicator for Micro	
1*	50	135	815	1100	15	170M3388*	170M3438*	—	170M3488*	—	
	63	215	1300	1750	20	170M3389*	170M3439*	—	170M3489*	—	
	80	420	2500	3350	25	170M3390*	170M3440*	—	170M3490*	—	
	100	750	4450	5950	30	170M3391*	170M3441*	—	170M3491*	—	
	125	1450	9000	11500	35	170M3392*	170M3442*	—	170M3492*	—	
	160	2600	16000	21000	40	170M3393*	170M3443*	—	170M3493*	—	
	200	5150	31000	41000	45	170M3394*	170M3444*	—	170M3494*	—	
	250	9200	54500	73000	55	170M3395*	170M3445*	—	170M3495*	—	
	315	18500	115000	150000	60	170M3396*	170M3446*	—	170M3496*	—	
	350	27000	165000	220000	65	170M3397*	170M3447*	—	170M3497*	—	
	400	53000	265000	335000	70	—	170M3448*	—	—	—	
	1	160	1900	11500	15500	45	170M4388*	170M4438*	—	170M4488*	—
200		3800	22500	30000	50	170M4389*	170M4439*	—	170M4489*	—	
250		7750	46000	61500	60	170M4390*	170M4440*	—	170M4490*	—	
315		15000	90000	120000	65	170M4391*	170M4441*	—	170M4491*	—	
350		20000	125000	165000	70	170M4392*	170M4442*	—	170M4492*	—	
400		29500	175000	235000	75	170M4393*	170M4443*	—	170M4493*	—	
450		42000	250000	335000	80	170M4394*	170M4444*	—	170M4494*	—	
500		69500	340000	435000	85	†170M4395	170M4445*	—	†170M4495	—	
550		95000	465000	590000	95	‡170M4396	170M4446*	—	‡170M4496	—	
630		130000	660000	—	100	‡170M4397	‡170M4447	—	‡170M4497	—	
2		250	6500	38500	51500	65	170M5388*	170M5438*	—	170M5588*	—
		280	9350	55500	74500	70	170M5389*	170M5439*	—	170M5589*	—
	315	13000	77500	105000	75	170M5390*	170M5440*	—	170M5590*	—	
	350	16500	97500	135000	80	170M5391*	170M5441*	—	170M5591*	—	
	400	23000	140000	180000	85	170M5392*	170M5442*	—	170M5592*	—	
	450	34000	205000	270000	90	170M5393*	170M5443*	—	170M5593*	—	
	500	48000	285000	380000	95	170M5394*	170M5444*	170M5494*	170M5594*	170M5644*	
	550	62000	370000	495000	100	170M5395*	170M5445*	170M5495*	170M5595*	170M5645*	
	630	115000	575000	730000	110	†170M5396	170M5446*	170M5496*	†170M5596	170M5646*	
	700	160000	795000	1050000	115	‡170M5397	‡170M5447	170M5497*	‡170M5597	170M5647*	
	800	245000	1200000	1550000	120	‡170M5398	‡170M5448	170M5498*	‡170M5598	170M5648*	
	†900	360000	1750000	—	125	—	—	170M5499	—	170M5649	
†1000	480000	2350000	—	135	—	—	170M5500	—	170M5650		
3	315	9500	58000	77500	85	170M6338*	170M6538*	—	170M6588*	—	
	350	13500	81500	110000	90	170M6339*	170M6539*	—	170M6589*	—	
	400	19500	120000	160000	95	170M6340*	170M6540*	—	170M6590*	—	
	450	31000	185000	245000	100	170M6341*	170M6541*	—	170M6591*	—	
	500	39000	235000	310000	105	170M6342*	170M6542*	—	170M6592*	—	
	550	55000	325000	435000	110	170M6343*	170M6543*	—	170M6593*	—	
	630	83500	495000	665000	115	170M6344*	170M6544*	170M6494*	170M6594*	170M6644*	
	700	115000	705000	940000	120	170M6345*	170M6545*	170M6495*	170M6595*	170M6645*	
	800	205000	995000	1300000	125	†170M6346	170M6546*	†170M6496	†170M6596	†170M6646	
	900	305000	1500000	1900000	130	‡170M6347	‡170M6547	‡170M6497	‡170M6597	‡170M6647	
	1000	450000	2150000	2750000	135	‡170M6348	‡170M6548	‡170M6498	‡170M6598	‡170M6648	
	1100	575000	2800000	3600000	140	‡170M6349	‡170M6549	‡170M6499	‡170M6599	‡170M6649	
†1250	810000	3950000	—	145	—	—	170M6500	—	170M6650		
†1400	1250000	6000000	—	150	—	—	170M6501	—	170M6651		

*UL Recognized / CSA Component Accepted. Rated voltage †1100 ‡1000V †1250V

Individual Fuse Weight: Size 1* = 0.380 Kg

Size 1 = 0.580 Kg

Size 2 = 0.900 Kg

Size 3 = 1.250 Kg

1 kg = 2.2 lbs. 1 lb = 0.45 kg

Data Sheet: 720031



European Style Square Body

French Standard—40-1500A

Voltage Rating: 690V (IEC), 700V (UL)

Interrupting Rating: 200kA (estimated 300kA) RMS Symmetrical

Agency Information: CSA Component Acceptance

UL Recognized, Std. 248-13 

Watts loss provided at rated current.

Microswitch indicator ordered separately. See bottom of page 146.



Electrical Characteristics

Ordering Information

Size	Rated Current RMS-Amps	I ² t (A ² s)		Watts Loss	-E/ Type T Indicator for Micro	-EKN/ Type K Indicator for Micro	Carton Qty.	Carton Weight (Kg)
		Pre-arc	Clearing at 660V					
1*	40	40	270	9	170M3308*	170M3358*	1	0.300
	50	77	515	11	170M3309*	170M3359*	1	0.300
	63	115	770	14	170M3310*	170M3360*	1	0.300
	80	185	1250	18	170M3311*	170M3361*	1	0.300
	100	360	2450	21	170M3312*	170M3362*	1	0.300
	125	550	3700	26	170M3313*	170M3363*	1	0.300
	160	1100	7500	30	170M3314*	170M3364*	1	0.300
	200	2200	15000	35	170M3315*	170M3365*	1	0.300
	250	4200	28500	40	170M3316*	170M3366*	1	0.300
	315	7000	46500	50	170M331z7*	170M3367*	1	0.300
	350	10000	68500	55	170M3318*	170M3368*	1	0.300
	400	15000	105000	60	170M3319*	170M3369*	1	0.300
	450	21000	140000	65	170M3320*	170M3370*	1	0.300
	500	27000	180000	70	170M3321*	170M3371*	1	0.300
	1	200	1650	11500	45	170M4308*	170M4358*	1
250		3100	21000	55	170M4309*	170M4359*	1	0.470
315		6200	42000	58	170M4310*	170M4360*	1	0.470
350		8500	59000	60	170M4311*	170M4361*	1	0.470
400		13500	91500	65	170M4312*	170M4362*	1	0.470
450		17000	120000	70	170M4313*	170M4363*	1	0.470
500		25000	170000	72	170M4314*	170M4364*	1	0.470
550		34000	230000	75	170M4315*	170M4365*	1	0.470
630		52000	350000	80	170M4316*	170M4366*	1	0.470
700		69500	465000	85	170M4317*	170M4367*	1	0.470
2	400	11000	74000	65	170M5308*	170M5358*	1	0.620
	450	15500	105000	70	170M5309*	170M5359*	1	0.620
	500	21500	145000	75	170M5310*	170M5360*	1	0.620
	550	28000	190000	80	170M5311*	170M5361*	1	0.620
	630	41000	275000	90	170M5312*	170M5362*	1	0.620
	700	60500	405000	95	170M5313*	170M5363*	1	0.620
	800	86000	575000	105	170M5314*	170M5364*	1	0.620
	900	125000	840000	110	170M5315*	170M5365*	1	0.620
	1000	180000	1250000	115	170M5316*	170M5366*	1	0.620
	3	500	14000	95000	95	170M6308*	170M6358*	1
550		19500	135000	100	170M6309*	170M6359*	1	0.930
630		31000	210000	105	170M6310*	170M6360*	1	0.930
700		44500	300000	110	170M6311*	170M6361*	1	0.930
800		69500	465000	115	170M6312*	170M6362*	1	0.930
900		100000	670000	120	170M6313*	170M6363*	1	0.930
1000		140000	945000	125	170M6314*	170M6364*	1	0.930
1100		190000	1300000	130	170M6315*	170M6365*	1	0.930
1250		290000	1950000	140	170M6316*	170M6366*	1	0.930
1400		370000	2450000	155	170M6317*	170M6367*	1	0.930
1500	460000	3100000	160	170M6318*	170M6368*	1	0.930	

*UL Recognized / CSA Component Accepted.



European Style Square Body

US Standard — 40-2000A

Voltage Rating: 690V (IEC), 700V (UL)

Interrupting Rating: 200kA (estimated 300kA) RMS Symmetrical

Agency Information: CSA Component Acceptance

UL Recognized, Std. 248-13 **CE**

Watts loss provided at rated current.

Microswitch indicator ordered separately. See bottom of page 146.



Electrical Characteristics

Ordering Information

Size	Rated Current RMS-Amps	I _t (A ² s)		Watts Loss	-FU/ Without Indicator	-FKE/ Type K Indicator for Micro	-FU/115 Without Indicator	-FKE/115 Type K Indicator for Micro	Carton Qty.	Carton Weight (Kg)
		Pre-arc	Clearing at 660V							
1*	40	40	270	9	170M3608*	170M3658*	170M3708*	170M3758*	1	0.340
	50	77	515	11	170M3609*	170M3659*	170M3709*	170M3759*	1	0.340
	63	115	770	14	170M3610*	170M3660*	170M3710*	170M3760*	1	0.340
	80	185	1250	18	170M3611*	170M3661*	170M3711*	170M3761*	1	0.340
	100	360	2450	21	170M3612*	170M3662*	170M3712*	170M3762*	1	0.340
	125	550	3700	26	170M3613*	170M3663*	170M3713*	170M3763*	1	0.340
	160	1100	7500	30	170M3614*	170M3664*	170M3714*	170M3764*	1	0.340
	200	2200	15000	35	170M3615*	170M3665*	170M3715*	170M3765*	1	0.340
	250	4200	28500	40	170M3616*	170M3666*	170M3716*	170M3766*	1	0.340
	315	7000	46500	50	170M3617*	170M3667*	170M3717*	170M3767*	1	0.340
	350	10000	68500	55	170M3618*	170M3668*	170M3718*	170M3768*	1	0.340
	400	15000	105000	60	170M3619*	170M3669*	170M3719*	170M3769*	1	0.340
	450	21000	140000	65	170M3620*	170M3670*	170M3720*	170M3770*	1	0.340
	500	27000	180000	70	170M3621*	170M3671*	170M3721*	170M3771*	1	0.340
	550	34000	230000	75	170M3622*	170M3672*	170M3722*	170M3772*	1	0.340
	630	48500	325000	80	170M3623*	170M3673*	170M3723*	170M3773*	1	0.340
	1	200	1650	11500	45	170M4608*	170M4658*	170M4708*	170M4758*	1
250		3100	21000	55	170M4609*	170M4659*	170M4709*	170M4759*	1	0.500
315		6200	42000	58	170M4610*	170M4660*	170M4710*	170M4760*	1	0.500
350		8500	59000	60	170M4611*	170M4661*	170M4711*	170M4761*	1	0.500
400		13500	91500	65	170M4612*	170M4662*	170M4712*	170M4762*	1	0.500
450		17000	120000	70	170M4613*	170M4663*	170M4713*	170M4763*	1	0.500
500		25000	170000	72	170M4614*	170M4664*	170M4714*	170M4764*	1	0.500
550		34000	230000	75	170M4615*	170M4665*	170M4715*	170M4765*	1	0.500
630		52000	350000	80	170M4616*	170M4666*	170M4716*	170M4766*	1	0.500
700		69500	465000	85	170M4617*	170M4667*	170M4717*	170M4767*	1	0.500
800		105000	725000	95	170M4618*	170M4668*	170M4718*	170M4768*	1	0.500
†900	155000	†850000	100	170M4619	170M4669	170M4719	170M4769	1	0.500	
2	400	11000	74000	65	170M5608*	170M5658*	170M5708*	170M5758*	1	0.630
	450	15500	105000	70	170M5609*	170M5659*	170M5709*	170M5759*	1	0.630
	500	21500	145000	75	170M5610*	170M5660*	170M5710*	170M5760*	1	0.630
	550	28000	190000	80	170M5611*	170M5661*	170M5711*	170M5761*	1	0.630
	630	41000	275000	90	170M5612*	170M5662*	170M5712*	170M5762*	1	0.630
	700	60500	405000	95	170M5613*	170M5663*	170M5713*	170M5763*	1	0.630
	800	86000	575000	105	170M5614*	170M5664*	170M5714*	170M5764*	1	0.630
	900	125000	840000	110	170M5615*	170M5665*	170M5715*	170M5765*	1	0.630
	1000	180000	1250000	115	170M5616*	170M5666*	170M5716*	170M5766*	1	0.630
	1100	245000	1600000	120	170M5617*	170M5667*	170M5717*	170M5767*	1	0.630
	1250	365000	2400000	130	170M5618*	170M5668*	170M5718*	170M5768*	1	0.630
	3	500	14000	95000	95	170M6608*	170M6658*	170M6708*	170M6758*	1
550		19500	135000	100	170M6609*	170M6659*	170M6709*	170M6759*	1	0.950
630		31000	210000	105	170M6610*	170M6660*	170M6710*	170M6760*	1	0.950
700		44500	300000	110	170M6611*	170M6661*	170M6711*	170M6761*	1	0.950
800		69500	465000	115	170M6612*	170M6662*	170M6712*	170M6762*	1	0.950
900		100000	670000	120	170M6613*	170M6663*	170M6713*	170M6763*	1	0.950
1000		140000	945000	125	170M6614*	170M6664*	170M6714*	170M6764*	1	0.950
1100		190000	1300000	130	170M6615*	170M6665*	170M6715*	170M6765*	1	0.950
1250		290000	1950000	140	170M6616*	170M6666*	170M6716*	170M6766*	1	0.950
1400		370000	2450000	155	170M6617*	170M6667*	170M6717*	170M6767*	1	0.950
1500		460000	3100000	160	170M6618*	170M6668*	170M6718*	170M6768*	1	0.950
1600		580000	3900000	160	170M6619*	170M6669*	170M6719*	170M6769*	1	0.950
†1800		880000	†5250000	165	170M6620	170M6670	170M6720	170M6770	1	0.950
‡2000	1150000	‡6350000	175	170M6621	170M6671	170M6721	170M6771	1	0.950	

*UL Recognized / CSA Component Accepted. Rated voltage †600V ‡550V



European Style Square Body

US Standard — 50-1400A

Voltage Rating: 1250V (IEC), 1300V (UL)

Interrupting Rating: 100kA RMS Symmetrical

Agency Information: CSA Component Acceptance

UL Recognized, Std. 248-13 **CE**

Watts loss provided at rated current.

Microswitch indicator ordered separately. See bottom of page 146.



Electrical Characteristics

Ordering Information

Size	Rated Current RMS-Amps	I _t (A ² s)			Watts Loss	-FU/115 Without Indicator	-FKE/115 Type K Indicator for Micro	Carton Qty.	Carton Weight (Kg)
		Pre-arc	Clearing at 1000V	Clearing at 1250V					
1*	50	135	815	1100	15	170M3688*	170M3738*	1	0.425
	63	215	1300	1750	20	170M3689*	170M3739*	1	0.425
	80	420	2500	3350	25	170M3690*	170M3740*	1	0.425
	100	750	4450	5950	30	170M3691*	170M3741*	1	0.425
	125	1450	9000	11500	35	170M3692*	170M3742*	1	0.425
	160	2600	16000	21000	40	170M3693*	170M3743*	1	0.425
	200	5150	31000	41000	45	170M3694*	170M3744*	1	0.425
	250	9200	54500	73000	55	170M3695*	170M3745*	1	0.425
	315	18500	115000	150000	60	170M3696*	170M3746*	1	0.425
	350	27000	165000	220000	65	170M3697*	170M3747*	1	0.425
1	160	1900	11500	15500	45	170M4688*	170M4738*	1	0.675
	200	3800	22500	30000	50	170M4689*	170M4739*	1	0.675
	250	7750	46000	61500	60	170M4690*	170M4740*	1	0.675
	315	15000	90000	120000	65	170M4691*	170M4741*	1	0.675
	350	20000	125000	165000	70	170M4692*	170M4742*	1	0.675
	400	29500	175000	235000	75	170M4693*	170M4743*	1	0.675
	450	42000	250000	335000	80	170M4694*	170M4744*	1	0.675
	†500	69500	340000	435000	85	170M4695	170M4745	1	0.675
	†550	95000	465000	590000	95	170M4696	170M4746	1	0.675
	‡630	130000	660000	—	100	170M4697	170M4747	1	0.675
2	250	6500	38500	51500	65	170M5688*	170M5738*	1	0.740
	280	9350	55500	74500	70	170M5689*	170M5739*	1	0.740
	315	13000	77500	105000	75	170M5690*	170M5740*	1	0.740
	350	16500	97500	135000	80	170M5691*	170M5741*	1	0.740
	400	23000	140000	180000	85	170M5692*	170M5742*	1	0.740
	450	34000	205000	270000	90	170M5693*	170M5743*	1	0.740
	500	48000	285000	380000	95	170M5694*	170M5744*	1	0.740
	550	62000	370000	495000	100	170M5695*	170M5745*	1	0.740
	630	115000	575000	730000	110	170M5696*	170M5746*	1	0.740
	†700	160000	795000	1050000	115	170M5697	170M5747	1	0.740
3	†800	245000	1200000	1550000	120	170M5698	170M5748	1	0.740
	†900	360000	1750000	—	125	170M5699	170M5749	1	0.740
	‡1000	480000	2350000	—	135	170M5700	170M5750	1	0.740
	315	9500	58000	77500	185	170M6688*	170M6738*	1	1.250
	350	13500	81500	110000	90	170M6689*	170M6739*	1	1.250
	400	19500	120000	160000	95	170M6690*	170M6740*	1	1.250
	450	31000	185000	245000	100	170M6691*	170M6741*	1	1.250
	500	39000	235000	310000	105	170M6692*	170M6742*	1	1.250
	550	55000	325000	435000	110	170M6693*	170M6743*	1	1.250
	630	83500	495000	665000	115	170M6694*	170M6744*	1	1.250
700	115000	705000	940000	120	170M6695*	170M6745*	1	1.250	
800	205000	995000	1300000	125	170M6696*	170M6746*	1	1.250	
900	305000	1500000	1900000	130	170M6697*	170M6747*	1	1.250	
¥1000	450000	2150000	2750000	135	†170M6698*	†170M6748*	1	1.250	
¥1100	575000	2800000	3600000	140	†170M6699*	†170M6749*	1	1.250	
¥1250	810000	3950000	—	145	‡170M6700*	‡170M6750*	1	1.250	
¥1400	1250000	6000000	—	150	‡170M6701*	‡170M6751*	1	1.250	

*UL Recognized / CSA Component Accepted. Rated voltage †1100V ‡1000V
 ¥ UL Recognized / CSA Component Accepted at 1000V



Indicator System

Indicators

Typower ZILOX fuses are available with three different indicator systems.

Visual Indicator

The indicator situated in one cover plate is clearly visible as soon as the fuse has operated. The minimum voltage for operating the indicator is 20V.

Type T Indicator

The indicator is situated on one cover plate with a cover plate tag to accommodate an auxiliary switch. The minimum voltage for operating the indicator is 20V. A special low voltage indicator (1.5V) is available on request.

Type K Indicator

This indicator is situated on the fuse body. It is covered by an adaptor for snap-on mounting of an auxiliary switch. The operating voltage of the indicator is 1.5V. As a matter of safety, the factory mounted adaptor must not be removed from the fuse.

Microswitch

The Typower ZILOX fuses with either type T indicator or type K indicator can be equipped with a microswitch for remote electrical indication of fuse operations. All microswitches have one normally open and one normally closed contact. Ratings are 2A, 250Vac.



Microswitch	6.3 x 0.8 mm Lugs	2.8 x 0.5 mm Lugs	Indicator Type
170H0235	x		T
170H0236	x		T
170H0237		x	T
170H0238		x	T
170H0069	x		K

Size	DIN 43 653		DIN 43 620		French Style		Flush End		US Style
	Type T	Type K	Type T	Type K	Type T	Type K	Type T	Type K	Type K
000	170H0236 170H0238		170H0236 170H0238						
00	170H0235 170H0237						170H0235 170H0237		
1*	170H0235 170H0237	170H0069	170H0235 170H0237		170H0236 170H0238	170H0069		170H0069	170H0069
1	170H0235 170H0237	170H0069			170H0236 170H0238	170H0069		170H0069	170H0069
2	170H0235 170H0237	170H0069	170H0235 170H0237		170H0236 170H0238	170H0069		170H0069	170H0069
3	170H0235 170H0237	170H0069	170H0236 170H0238		170H0236 170H0238	170H0069		170H0069	170H0069
4								170H0069	
23								170H0069	
24								170H0069	

Data Sheet: 720034



Fuse Bases (Blocks)

DIN 43 653 Fuse Bases

For the Typower ZILOX fuses according to DIN 43 653, the following fuse bases are available:

Part Number	Max. Voltage	Rated Current	Center Distance
170H3003	1000V	630A	80mm
170H3004	1000V	1250A	80mm
170H3005	1400V	630A	110mm
170H3006	1400V	1250A	110mm

The fuse bases rated 1250A can also be used for the fuses with higher rated current if the maximum load current is derated according to the table below:

Fuse Rating	Max. Load Current In Fuse Base
1400A	1325A
1500A	1400A
1600A	1500A
1800A	1650A
2000A	1800A

Fixed Center Base Style	Max. Voltage	Max. Fuse Current Rating	Fuse Size
170H1007*	1000V	400A	00, 000
170H1013*	660V	200A	0000,000

*UL Recognized to UL 512.

Universal Fuse Bases

For the Typower ZILOX fuses according to DIN 43 653, French style and North American style, the following fuse bases are available:

Modular Base Style	Max. Voltage	Max. Fuse Current Rating	BIF Document
1BS101	600V	100A	1206
1BS102	600V	400A	1207
1BS103	600V	400A	1208
1BS104	600V	600A	1209
BH-0XXX	700V	100A	1200
BH-1XXX	2500V	400A	1201
BH-2XXX	5000V	400A	1202
BH-3XXX	1250V	700A	1203

Universal fuse bases are UL Recognized to UL 512 and meet the spacing requirements of UL 347. Contact Bussmann sales representative for more complete ordering information.

DIN 43 620 Fuse Bases

For fuse bases used with Typower ZILOX fuses according to DIN 43 620, please contact your local Bussmann sales representative.



170H3003



170H1007



1BS104



British Standard BS88: Part 4

Voltage Rating

240Vac/150Vdc	6 to 900A
690Vac/450Vdc	6 to 700A

All Bussmann British Style fuses are tested to IEC 269: Part 4. This standard requires a test voltage which is 10% higher than the rated voltage. In North America, fuses are required to clear only their rated voltage.

Designed and tested to:

- BS 88: Part 4
- IEC 60269: Part 4
- UL Recognized, Std. 248-13

Bussmann British Style products use innovative arc quenching techniques and high grade materials to provide:

- Minimal energy let-thru (I²t)
- Excellent DC performance
- Good surge withstand profile



Accessories

Trip-indicator fuses are available for use in parallel with the main fuse. Indicator fuses can be attached to the associated fuselink, or mounted separately in panel-mounted fuseclips. In addition, a push-on adaptor and microswitch attachment are available, to provide remote indication. Fuseblocks are also available for most applications.

240Vac/150Vdc - 6 to 900A

Interrupting Rating: 200kA RMS Symmetrical.

Agency Information: UL Recognized, Std. 248-13

Watts loss provided at rated current.

CE CE logo denotes compliance with European Union Low Voltage Directive (50-1000Vac, 75-1500Vdc. Refer to Data Sheet: 8002 or contact Bussmann Application Engineering at 636-527-1270 for more information.

Electrical Characteristics

Ordering Information

Size	Rated Current RMS-Amps	I ² t (A ² SEC)			Watts Loss	Part Number	Carton Qty.	Carton Weight (Kg)
		Pre-arc	Clearing at 120V	Clearing at 240V				
LCT	6	2	6	9	1.0	6LCT	20	0.110
	10	3.8	12	22	2.5	10LCT	20	0.110
	12	7	22	32	2.5	12LCT	20	0.110
	16	20	50	100	2.5	16LCT	20	0.110
	20	25	80	160	4.0	20LCT	20	0.110
LET	25	18	120	250	4.0	25LET	10	0.310
	32	32	200	450	5.0	32LET	10	0.310
	35	50	320	600	5.0	35LET	10	0.310
	50	100	500	1400	7.0	50LET	10	0.310
	63	180	1100	2200	9.0	63LET	10	0.310
	80	300	1900	3800	10.0	80LET	10	0.310
	100	600	3800	7500	10.0	100LET	10	0.310
	125	600	3800	7500	16.0	125LET	10	0.310
	160	1100	7000	16000	20.0	160LET	10	0.310
	180	1600	12000	29000	21.0	180LE1a	10	0.310
LMT	160	1100	7000	16000	17.0	160LMT	1	0.180
	200	1500	10000	20000	28.0	200LMT	1	0.180
	250	3200	20000	40000	28.0	250LMT	1	0.180
	315	6000	35000	75000	35.0	315LMT	1	0.180
	355	8000	50000	100000	35.0	355LMT	1	0.180
	400	14000	70000	160000	40.0	400LMT	1	0.180
	450	18000	100000	220000	42.0	450LMT	1	0.180
LMMT	400	6000	35000	80000	60.0	400LMMT	1	0.370
	500	14000	80000	170000	64.0	500LMMT	1	0.370
	630	24000	150000	300000	75.0	630LMMT	1	0.370
	710	32000	200000	460000	77.0	710LMMT	1	0.370
	800	52000	300000	600000	82.0	800LMMT	1	0.370
	900	75000	400000	800000	97.0	900LMMT	1	0.370

Note: 7LET, 10LET, 12LET and 16LET are available for replacement purposes on existing equipment (not UL recognized).

Data Sheet: 720004



British Standard BS88: Part 4

690Vac/500Vdc 6-700A

Interrupting Rating: 200kA RMS Symmetrical.

UL Recognized, Std. 248-13, Watts loss provided at rated current.

MT, MMT and additional ratings of ET and EET are available for replacement purposes on existing equipment and are BS 88: Part 4 approved. **CE**



Electrical Characteristics

Ordering Information

Size	Rated Current RMS-Amps	I ² t (A ² SEC)			Watts Loss	Part Number	Carton Qty.	Carton Weight (Kg)
		Pre-arc	Clearing at 415V	Clearing at 660V				
CT	6	1.8	8.5	12	2	6CT	20	0.160
	10	7	30	48	3	10CT	20	0.160
	12	10	40	65	3	12CT	20	0.160
	16	16	66	110	7	16CT	20	0.160
	20	32	150	220	7	20CT	20	0.160
	25	25	150	250	7	25ET	10	0.420
ET	32	32	190	350	11	32ET	10	0.420
	35	52	310	500	11	35ET	10	0.420
	40	103	600	900	9	40ET	10	0.420
	45	103	680	1100	11	45ET	10	0.420
	56	135	950	1500	14	56ET	10	0.420
	63	171	1200	2000	16	63ET	10	0.420
	80	360	2500	4000	18	80ET	10	0.420
	35	33	130	200	9	35FE	10	0.420
	40	52	180	300	9	40FE	10	0.420
	45	76	270	450	11	45FE	10	0.420
FE	50	103	380	600	11	50FE	10	0.420
	63	135	480	750	12	63FE	10	0.420
	71	210	600	950	17	71FE	10	0.420
	80	250	900	1500	20	80FE	10	0.420
	90	360	1300	2100	20	90FE	10	0.420
	100	470	1800	2800	23	100FE	10	0.420
EET	90	490	3000	4500	19	90EET	5	0.450
	110	600	4000	6500	27	110EET	5	0.450
	140	1050	7000	12000	35	140EET	5	0.450
	160	1500	10000	17000	39	160EET	5	0.450
	100	400	1600	2400	24	100FEE	5	0.450
FEE	120	540	1900	3100	32	120FEE	5	0.450
	140	850	2500	3800	36	140FEE	5	0.450
	160	1000	3700	5700	46	160FEE	5	0.450
	180	1400	5300	8400	46	180FEE	5	0.450
	200	1900	7100	11400	52	200FEE	5	0.450
	180	1400	7500	13500	40	180FM	1	0.240
FM	200	2600	10500	18500	40	200FM	1	0.240
	225	3700	14500	26500	44	225FM	1	0.240
	250	5200	20500	37500	48	250FM	1	0.240
	280	7000	30500	55000	48	280FM	1	0.240
	315	10000	40000	77000	55	315FM	1	0.240
	350	15000	60000	105000	55	350FM	1	0.240
FMM	400	10000	40000	72500	85	400FMM	1	0.450
	450	15000	60000	105000	90	450FMM	1	0.450
	500	20000	82000	150000	100	500FMM	1	0.450
	550	30000	120000	215000	100	550FMM	1	0.450
	630	45000	180000	310000	100	630FMM	1	0.450
	700	60000	245000	420000	120	700FMM	1	0.450
	160	2400	15000	25000	26	160MT	1	0.260
MT†	180	3800	25000	38000	26	180MT	1	0.260
	200	6000	40000	58000	27	200MT	1	0.260
	250	11500	80000	110000	32	250MT	1	0.260
	280	16500	100000	150000	35	280MT	1	0.260
	315	19000	125000	180000	42	315MT	1	0.260
	355	22000	160000	200000	51	355MT	1	0.260
MMT†	180	1650	12000	18000	42	180MMT	1	.0470
	200	2200	16000	23000	42	200MMT	1	.0470
	225	3700	26000	40000	42	225MMT	1	.0470
	280	6600	47000	70000	47	280MMT	1	.0470
	315	8600	62000	91000	51	315MMT	1	.0470
	355	13500	97000	140000	54	355MMT	1	.0470
	400	21000	150000	220000	60	400MMT	1	.0470
	450	30000	220000	320000	57	450MMT	1	.0470
	500	42000	300000	450000	64	500MMT	1	.0470
	560	60000	430000	640000	64	560MMT	1	.0470
MMT†	630	68500	500000	720000	86	630MMT	1	.0470
	710	78000	600000	850000	105	710MMT	1	.0470

Note: 8ET, 12ET, 15ET, 20ET, 65EET and 75EET are available for replacement purposes on existing equipment (not UL recognized).

† 350Vdc (IEC) rating. No UL Recognition.



For complete specification data, call Bussmann Information Fax ~ 636.527.1450

Data Sheet: 720024

Indicator System and Fuse Bases (Blocks)



Trip Indicator

Trip-indicator fuselinks are available for use in parallel with the main fuselinks. They can either be attached to the associated fuselink or mounted separately in panel mounted fuse clips, Part No. CL1. A push-on adaptor and microswitch attachment is available for use with the trip indicator to give the facility of remote indication, reference MAI or MBI.

Fuse ratings of 20A and below cannot usually accommodate a trip fuselink in parallel.

Where trip indicator fuselinks are to be attached to the main fuselink, an accessory pack comprising a pair of mounting clips and an appropriate trip indicator fuselink will be required.

The ordering code references for these packs are listed below:

Fuse Type	Order Ref.	Fuse Type	Order Ref.
ET	EC-600	FM	MC-600
EET	EC-600	FMM	MC-600
FE	EC-600	LMT	MC-250
FEE	EC-600	LMMT	MC-250
LET	EC-250		

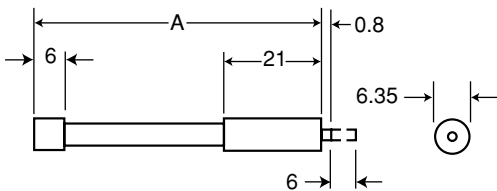

Dimensions in mm.
1mm = 0.0394" 1" = 25.4mm

Trip-indicator Fuselink Data

Type	Dim. 'A' Max.	Voltage Rating	Type	Dim. 'A' Max.	Voltage Rating
Ti250	37.6	250	TI1100	98.4	1100
Ti500	47.5	500	TI1500	120.8	1500
Ti600	55.7	600	TI2000	147.5	2000
Ti700	61.8	700	TI2500	198.3	2500

Microswitch and Adaptor Type MAI

Current Rating:	
ac 50/60Hz resistive load @ 250 VRMS	4A
ac 50/60Hz resistive load @ 127 VRMS	6A
dc, resistive load @ 110 Vdc	0.7
dc, resistive load @ 30 Vdc	2
Maximum Working Voltage:	
Contact-to-contact (RMS)	1000V
Contact-to-contact (RMS)	1500V

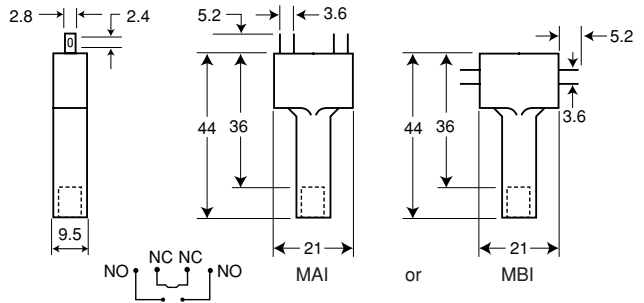

Stud Fuseblocks

Part No.	Stud Height	Stud Dia. & Threads
C5268-1	1.00"	5/16-18
C5268-2	1.75"	5/16-18
C5268-3	0.75"	5/16-18
C5268-4	1.00"	1/4-20
C5268-5	1.75"	1/4-20

Universal Fuseblocks

Modular Base	Max. Voltage	Max. Fuse Current Rating	Data Sheet
1BS101	600V	100A	1206
1BS102	600V	400A	1207
1BS103	600V	400A	1208
1BS104	600V	600A	1209

Data Sheet: 720037



Ferrule Style



Voltage Rating

150Vac/dc	5 to 60A
250Vac/dc*	1 to 50A
500Vac/dc*	0.25 to 30A
600 ac/400 dc	6 to 32A
700Vac/dc**	1 to 50A
700Vac	1 to 100A
750Vac/dc	5 to 60A
1000 ac/800 dc	20 to 30A
1250 ac/1000 dc	20 to 30A
1500 ac/1000 dc	8 to 15A
2000/1000Vac/dc	2 to 6A

*dc is for 5-30A

**500Vdc for 63-100A

All Bussmann Ferrule fuses—except 690V—have been tested at their rated voltage. The 690V Ferrule fuse has been tested to the IEC 60269 standard, which requires clearing at the rated voltage +5%.

Select Fuses designed and tested to:

- IEC 60269: Part 4
- UL Recognized, Std. 248-13

Bussmann offers a full line of Ferrule Style (cylindrical and clip-mounted) fuses, designed and tested to meet standards and requirements in various locations around the world. Their unique design and construction provide:

- Superior cycling capability
- Low energy let-thru (I²t)

Ferrule fuses provide an excellent solution for small UPS, small AC drives and other low power applications where space is at a premium.

Accessories

Ferrule fuses may be mounted in fuse clips, fuseholders, fuseblocks or fused switches. A variety of products are available to suit most end-use requirements.

FWA 150Vac/150Vdc

Interrupting Rating: 100kA RMS Symmetrical.

Agency Information: UL Recognized, 150V, Std. 248-13

Watts loss provided at rated current.

CE

Electrical Characteristics

Size	Rated Current RMS-Amps	I ² t (A ² SEC)		Watts Loss	Part Number	Carton Qty.	Carton Weight (Kg)
		Pre-arc	Clearing at 150V				
10 x 38 mm (1 ¹ / ₃₂ "	5	1.6	8	1	FWA-5A10F	10	0.100
	10	3.6	16	2.7	FWA-10A10F	10	0.100
	15	14	55	3.3	FWA-15A10F	10	0.100
	20	33	130	3.8	FWA-20A10F	10	0.100
	25	58	220	4.9	FWA-25A10F	10	0.100
21 x 51 mm (1 ¹ / ₁₆ "	30	100	400	4.9	FWA-30A10F	10	0.100
	35	75	800	4.5	FWA-35A21F	10	0.600
	40	100	1000	5.1	FWA-40A21F	10	0.600
	45	130	1300	6	FWA-45A21F	10	0.600
	50	170	1600	7.3	FWA-50A21F	10	0.600
	60	250	2400	8.0	FWA-60A21F	10	0.600



Ordering Information



For complete specification data, call Bussmann Information Fax ~ 636.527.1450

Data Sheet: 720003

Ferrule Style



FWX 250Vac/250Vdc (250Vdc on 5 through 30)

Interrupting Rating: 200kA RMS Symmetrical.

Agency Information: UL Recognized, 250V, Std. 248-13 & CSA Component Acceptance

Watts loss provided at rated current. ce

Electrical Characteristics

Ordering Information

Size	Rated Current RMS-Amps	I^2t (A ² SEC)		Watts Loss	Part Number	Carton Qty.	Carton Weight (Kg)
		Pre-arc	Clearing at 250V				
14 x 51mm	1	—	—	—	FWX-1A14F	10	0.225
	2	—	—	—	FWX-2A14F	10	0.225
	3	—	—	—	FWX-3A14F	10	0.225
	4	—	—	—	FWX-4A14F	10	0.225
	5	1.6	13	1.3	FWX-5A14F	10	0.225
	10	3.6	24	3.4	FWX-10A14F	10	0.225
	15	14	83	3.8	FWX-15A14F	10	0.225
	20	33	200	4.6	FWX-20A14F	10	0.225
	25	58	300	5.3	FWX-25A14F	10	0.225
	30	100	500	5.9	FWX-30A14F	10	0.225
50	200	1800	5.7	FWX-50A14F	10	0.225	

Fuse Block: 1976 - (pole) Data Sheet: 1210

Data Sheet: 720006

FWH 500Vac/500Vdc

Interrupting Rating: 6 mm x 32 mm (Interrupting rating varies—See Data Sheet for details)

14 mm x 51 mm (200kA RMS Symmetrical).

Agency Information: UL Recognized, 500V, Std. 248-13 & CSA Component Acceptance

Watts loss provided at rated current.

ce CE logo denotes compliance with European Union Low Voltage Directive (50-1000Vac, 75-1500Vdc). Refer to Data Sheet: 8002 or contact Bussmann Application Engineering at 636-527-1270 for more information.

Electrical Characteristics

Ordering Information

Size	Rated Current RMS-Amps	I^2t (A ² SEC)		Watts Loss	Part Number	Carton Qty.	Carton Weight (Kg)
		Pre-arc	Clearing at 500V				
6 x 32 mm ($\frac{1}{4}$ " x $\frac{1}{4}$ ")	0.25	0.01	0.05	2.7	FWH-.250A6F*	10	0.03
	0.5	0.05	0.25	1.2	FWH-.500A6F*	10	0.03
	1	0.4	2	1.7	FWH-001A6F*	10	0.03
	2	1.3	3.5	3.2	FWH-002A6F*	10	0.03
	3.15	3.1	7.7	2.9	FWH-3.15A6F*	10	0.03
	5	15	40	2.1	FWH-005A6F*	10	0.03
	6.3	36	90	2.3	FWH-6.30A6F*	10	0.03
	7	50	125	2.5	FWH-007A6F*	10	0.03
	10	9.9	139	2.86	FWH-010A6F	10	0.03
	12.5	20	60	3.53	FWH-12.5A6F	10	0.03
	15	44	146	3.08	FWH-015A6F	10	0.03
	16	48	177	4.48	FWH-016A6F	10	0.03
	20	75	259	4.26	FWH-020A6F	10	0.03
	25	126	345	—	FWH-025A6F	10	0.03
	30	145	430	—	FWH-030A6F	10	0.03
14 x 51mm ($\frac{9}{16}$ ")	1	—	—	—	FWH-1A14F	10	0.250
	2	—	—	—	FWH-2A14F	10	0.250
	3	—	—	2.3	FWH-3A14F	10	0.250
	4	—	—	—	FWH-4A14F	10	0.250
	5	1.6	6.4	1.5	FWH-5A14F**	10	0.250
	6	1.6	6.4	1.5	FWH-6A14F**	10	0.250
	10	3.6	13	4	FWH-10A14F**	10	0.250
	12	—	—	—	FWH-12A14F**	10	0.250
	15	10	40	5.5	FWH-15A14F**	10	0.250
	20	26	96	6	FWH-20A14F**	10	0.250
	25	49	191	7	FWH-25A14F**	10	0.250
	30	58	232	9	FWH-30A14F**	10	0.250

*CSA Component Acceptance

**UL Recognized & CSA Component Acceptance at 500Vdc

Data Sheet: 14mm x 51mm, 720008 & 6mm x 32mm, 720038



Ferrule Style

FWC 600Vac

Interrupting Rating: 200kA RMS Symmetrical.

Agency Information: UL Recognized, 600V, Std. 248-13

Watts loss provided at rated current.



CE logo denotes compliance with European Union Low Voltage Directive (50-1000Vac, 75-1500Vdc). Refer to Data Sheet: 8002 or contact Bussmann Application Engineering at 636-527-1270 for more information.

Electrical Characteristics

Ordering Information

Size	Rated Current RMS-Amps	I ² t (A ² SEC)		Watts Loss	Part Number	Carton Qty.	Carton Weight (Kg)
		Pre-arc	Clearing at 600V				
10 x 38 mm (¹³ / ₃₂ "	6	4	30	1.5	FWC-6A10F	10	0.100
	8	6	50	2.0	FWC-8A10F	10	0.100
	10	9	70	2.5	FWC-10A10F	10	0.100
	12	15	120	3.0	FWC-12A10F	10	0.100
	16	25	150	3.5	FWC-16A10F	10	0.100
	20	34	260	4.8	FWC-20A10F	10	0.100
	25	60	390	6.0	FWC-25A10F	10	0.100
	32	95	600	7.5	FWC-32A10F	10	0.100

Fuse Block: BM Series Data Sheet: 1104

■ 400Vdc UL Recognition: 32A: Interrupting Rating = 50kA

■ 700Vdc UL Recognition: 6-25A: Interrupting Rating = 50kA

Data Sheet: 720011

FWP 690V/700V (IEC/UL)

Interrupting Rating: 200kA RMS Symmetrical.

Agency Information: UL Recognized, 700V, Std. 248-13 & CSA Component Acceptance.

Watts loss provided at rated current.



CE logo denotes compliance with European Union Low Voltage Directive (50-1000Vac, 75-1500Vdc). Refer to Data Sheet: 8002 or contact Bussmann Application Engineering at 636-527-1270 for more information.

Electrical Characteristics

Ordering Information

Size	Rated Current RMS-Amps	I ² t (A ² SEC)		Watts Loss	Part Number	Carton Qty.	Carton Weight (Kg)
		Pre-arc	Clearing at 660V				
14 x 51mm (⁹ / ₁₆ "	1	—	—	—	FWP-1A14F	5	0.113
	2	—	—	—	FWP-2A14F	5	0.113
	2.5	—	—	—	FWP-2.5A14F	5	0.113
	3	—	—	—	FWP-3A14F	5	0.113
	4	—	—	—	FWP-4A14F	5	0.113
	5	1.6	4	1.5	FWP-5A14F	10	0.225
	6.3	—	—	—	FWP-6.3A14F	10	0.225
	10	3.6	10	4	FWP-10A14F	10	0.225
	15	10	22	5.5	FWP-15A14F	10	0.225
	20	26	60	6	FWP-20A14F	10	0.225
	25	44	130	7	FWP-25A14F	10	0.225
	30	58	150	9	FWP-30A14F	10	0.225
	32	95	800	7.6	FWP-32A14F	5	0.113
	40	110	980	8	FWP-40A14F	5	0.113
	50	220	1800	9	FWP-50A14F	5	0.113

Fuse Block: 1976 - (pole) Data Sheet: 1210

□ CSA Component Acceptance 5-30A

Data Sheet: 720025



For complete specification data, call Bussmann Information Fax ~ 636.527.1450

Ferrule Style

FWP 690V/700V (IEC/UL)

Interrupting Rating: 200kA RMS Symmetrical.

Agency Information: UL Recognized, 700V, Std. 248-13 & CSA Component Acceptance

Watts loss provided at rated current.



CE CE logo denotes compliance with European Union Low Voltage Directive (50-1000Vac, 75-1500Vdc). Refer to Data Sheet: 8002 or contact Bussmann Application Engineering at 636-527-1270 for more information.

Electrical Characteristics

Ordering Information

Size	Rated Current RMS-Amps	I ² t (A ² SEC)		Watts Loss	Part Number	Carton Qty.	Carton Weight (Kg)
		Pre-arc	Clearing at 660V				
22 x 58 mm (7/8")	20	34	370	4.6	FWP-20A22F	10	0.450
	25	60	560	5.6	FWP-25A22F	10	0.450
	32	95	850	7.0	FWP-32A22F	10	0.450
	40	185	1350	8.5	FWP-40A22F	10	0.450
	50	155	1120	9.5	FWP-50A22F	10	0.450
	63	310	2700	11	FWP-63A22F	10	0.450
	80	620	5100	13.5	FWP-80A22F	10	0.450
	100	1250	10000	16	FWP-100A22F	10	0.450

Fuse Block: J70100 - (pole) CR Data Sheet: 1211

■ 500Vdc UL Recognition: Interrupting Rating = 50kA

Data Sheet: 720026

FWK 750V 5-60A

Electrical Characteristics				Ordering Information				Dimensions
Size	Rated Current RMS-Amps	I ² t (A ² S)		Watts Loss	Part Number	Carton Qty.	Carton Weight (kg)	Figure Number
		Pre-arc	Clearing at 750 VDC					
20 x 127mm (13/16")	5	8.5	16	—	FWK-5A20F	10	0.95	Fig. 1
	8	50	100	—	FWK-8A20F			
	10	95	200	—	FWK-10A20F			
	15	100	240	—	FWK-15A20F			
	20	125	315	—	FWK-20A20F			
	25	400	1100	—	FWK-25A20F			
25 x 146mm (1")	30	800	2600	—	FWK-30A20F	10	1.65	Fig. 2
	35	1300	4300	—	FWK-35A25F			
	40	1600	5300	—	FWK-40A25F			
	50	3100	12000	—	FWK-50A25F			
	60	5900	24000	—	FWK-60A25F			

■ Interrupting rating 45kA RMS symmetrical.

■ 750Vdc rating for 5 through 60A (Time constant = 10-15 mS).

1 kg = 2.2 lbs. 1 lb = 0.45 kg

Data Sheet: 720039



Ferrule Style

FWJ 1000Vac

Interrupting Rating: 25kA RMS Symmetrical.

Agency Information: UL Recognized, 1000Vac/800Vdc, Std. 248-13

Watts loss provided at rated current.



CE CE logo denotes compliance with European Union Low Voltage Directive (50-1000Vac, 75-1500Vdc). Refer to Data Sheet: 8002 or contact Bussmann Application Engineering at 636-527-1270 for more information.

Electrical Characteristics

Ordering Information

Size	Rated Current RMS-Amps	I ² t (A ² SEC)		Watts Loss	Part Number	Carton Qty.	Carton Weight (Kg)
		Pre-arc	Clearing at 1000V				
14 × 67 mm (¹³ / ₁₆ "	20	25	220	9	FWJ-20A14F	10	0.300
	25	33	350	11	FWJ-25A14F	10	0.300
	30	52	450	14	FWJ-30A14F	10	0.300

■ 800Vdc UL Recognition

Data Sheet: 720028

FWL/FWS 1250V/1500V/2000V

Size	Electrical Characteristics			Ordering Information				Dimensions	Curves
	Rated Current RMS-Amps	I ² t (A ² S)		Watts Loss	Part Number	Carton Qty.	Carton Weight (kg)	Figure Number	See Page
		Pre-arc	Clearing at 1000 Vdc						
20 × 127mm (¹³ / ₁₆ "	¥2	0.8	2.4	4.4	FWS-2A20F	10	1.00	Fig. 1	page 108
	¥6	27	81	6.7	FWS-6A20F				
	†8	64	192	7.6	FWS-8A20F				
	†10	118	277	3.0	FWS-10A20F				
	†12	170	380	3.4	FWS-12A20F				
	†15	209	500	5.0	FWS-15A20F				
	‡20	675	1550	5.9	FWL-20A20F				
	‡25	1200	2760	6.5	FWL-25A20F				
	‡30	1850	4300	7.5	FWL-30A20F				

- Interrupting rating 45kA RMS Symmetrical.
- Rated voltage (IEC) ¥2000V †1500V ‡1250V
- 1000Vdc/30kA rating.

1 kg = 2.2 lbs. 1 lb = 0.45 kg



Page 156

BLANK

(Do NOT Print)

BBU Boric Acid Fuse-Features

Construction

Principle parts of the replaceable BBU fuse unit are shown in the cross section view. Main operating parts are the silver element, arcing rod, boric acid cylinder, and spring. A glass epoxy tube encloses the assembly.

The use of a pure silver element and Nichrome wire strain element makes the BBU less susceptible to outages caused by vibration, corona corrosion, and aging of the fuse elements.



BBU Fuse Construction

The components are housed in a fiberglass reinforced resin tube with plated copper contacts. Positive connection is maintained between the arcing rod and contact with a sliding tulip contact.

Operation

BBU Expulsion Fuses utilize the proven performance of boric acid to create the de-ionizing action needed to interrupt the current. Fault interrup-

tion is achieved by the action of an arcing rod and a charged spring, elongating the arc through a boric acid chamber upon release by the fuse element.



Element Melts Rod withdraws, elongating arc and vaporizing Boric Acid Vapor quenches arc at first current zero

At high temperatures, boric acid decomposes producing a blast of water vapor and inert boric anhydride. Electrical interruption is caused by the steam extinguishing the arc, as the arc is being elongated through the cylinder.

Higher particle turbulence of the boric acid causes the rate of de-ionization in the cylinder to exceed the ionization of the electrical arc. Both high and low current faults are interrupted in the same manner with no foreign material other than the boric acid required. This enables the fuse to interrupt short circuits within one-half cycle and prevents the arc from restriking after a current zero.

After interruption, the gases are expelled from the bottom of the fuse. The arching rod is prevented from falling back into its original position by a friction stop at the top of the fuse unit.

When the fuse operates, the upward motion of the spring forces the top of the arcing rod to penetrate the upper seal, striking the latch mechanism. On indoor applications, this action caused the blown fuse indicator to actuate.

When replacing the blown fuse, the end fittings should be removed from the operated fuse unit, and if undamaged, clamped onto the new fuse unit.

Application

The BBU Boric acid Fuse provides effective protection for circuits and equipment which operate on voltage systems up to 34,500V. They can be used on industrial distribution systems and all fuses are designed for use on the following:

- Power Transformers
- Feeder Circuits
- Distribution Transformers
- Metal-enclosed Switchgear
- Pad Mount Switches

BBU Fuse units can be used in indoor applications, and can be used to directly replace competitive equivalent units.

BBU End Fittings

End Fittings are required to complete the electrical connection between the fuse unit and the live parts and mounting.

End fittings are positioned on the top and bottom of the fuse unit. They can be used over again if they remain undamaged.

The indoor fittings accept a Muffler attachment to limit noise and contamination to indoor equipment. The blown fuse indicator located on the top end fitting, provides visual indication of a faulted fuse unit.



BBU Boric Acid Fuses for Use Indoors

Amps	Fuse Type	Voltage (kV)	Catalog Number	Max. Int. kA Sym	Indoor		
					End Fittings	Catalog Number	Ampere Rating
3	k	17	BBU17-3K	14		BBU-EFID	3K to 200K
6	k	17	BBU17-6K				
8	k	17	BBU17-8K				
10	k	17	BBU17-10K				
12	k	17	BBU17-12K				
15	k	17	BBU17-15K				
20	k	17	BBU17-20K				
25	k	17	BBU17-25K				
30	k	17	BBU17-30K				
40	k	17	BBU17-40K				
50	k	17	BBU17-50K				
65	k	17	BBU17-65K				
80	k	17	BBU17-80K				
100	k	17	BBU17-100K				
140	k	17	BBU17-140K				
200	k	17	BBU17-200K				
5	E	17	BBU17-5E	14		BBU-EFID	5E to 200E
7	E	17	BBU17-7E				
10	E	17	BBU17-10E				
13	E	17	BBU17-13E				
15	E	17	BBU17-15E				
20	E	17	BBU17-20E				
25	E	17	BBU17-25E				
30	E	17	BBU17-30E				
40	E	17	BBU17-40E				
50	E	17	BBU17-50E				
65	E	17	BBU17-65E				
80	E	17	BBU17-80E				
100	E	17	BBU17-100E				
125	E	17	BBU17-125E				
150	E	17	BBU17-150E				
175	E	17	BBU17-175E				
200	E	17	BBU17-200E				
15	SE	17	BBU17-15SE	14		BBU-EFID	15SE to 200SE
20	SE	17	BBU17-20SE				
25	SE	17	BBU17-25SE				
30	SE	17	BBU17-30SE				
40	SE	17	BBU17-40SE				
50	SE	17	BBU17-50SE				
65	SE	17	BBU17-65SE				
80	SE	17	BBU17-80SE				
100	SE	17	BBU17-100SE				
125	SE	17	BBU17-125SE				
150	SE	17	BBU17-150SE				
175	SE	17	BBU17-175SE				
200	SE	17	BBU17-200SE				
3	k	27	BBU27-3K				
6	k	27	BBU27-6K				
8	k	27	BBU27-8K				
10	k	27	BBU27-10K				
12	k	27	BBU27-12K				
15	k	27	BBU27-15K				
20	k	27	BBU27-20K				
25	k	27	BBU27-25K				
30	k	27	BBU27-30K				
40	k	27	BBU27-40K				
50	k	27	BBU27-50K				
65	k	27	BBU27-65K				
80	k	27	BBU27-80K				
100	k	27	BBU27-100K				
140	k	27	BBU27-140K				
200	k	27	BBU27-200K				
5	E	27	BBU27-5E	12.5		BBU-EFID	5E to 200E
7	E	27	BBU27-7E				
10	E	27	BBU27-10E				
13	E	27	BBU27-13E				
15	E	27	BBU27-15E				
20	E	27	BBU27-20E				
25	E	27	BBU27-25E				
30	E	27	BBU27-30E				
40	E	27	BBU27-40E				

Amps	Fuse Type	Voltage (kV)	Catalog Number	Max. Int. kA Sym	Indoor						
					End Fittings	Catalog Number	Ampere Rating				
50	E	27	BBU27-50E	12.5		BBU-EFID	5E to 200E				
65	E	27	BBU27-65E								
80	E	27	BBU27-80E								
100	E	27	BBU27-100E								
125	E	27	BBU27-125E								
150	E	27	BBU27-150E								
175	E	27	BBU27-175E								
200	E	27	BBU27-200E								
15	SE	27	BBU27-15SE					12.5		BBU-EFID	15SE to 200SE
20	SE	27	BBU27-20SE								
25	SE	27	BBU27-25SE								
30	SE	27	BBU27-30SE								
40	SE	27	BBU27-40SE								
50	SE	27	BBU27-50SE								
65	SE	27	BBU27-65SE								
80	SE	27	BBU27-80SE								
100	SE	27	BBU27-100SE								
125	SE	27	BBU27-125SE								
150	SE	27	BBU27-150SE								
175	SE	27	BBU27-175SE								
200	SE	27	BBU27-200SE								
3	k	38	BBU38-3K	10		BBU-EFID	3K to 200K				
6	k	38	BBU38-6K								
8	k	38	BBU38-8K								
10	k	38	BBU38-10K								
12	k	38	BBU38-12K								
15	k	38	BBU38-15K								
20	k	38	BBU38-20K								
30	k	38	BBU38-30K								
40	k	38	BBU38-40K								
50	k	38	BBU38-50K								
65	k	38	BBU38-65K								
80	k	38	BBU38-80K								
100	k	38	BBU38-100K								
140	k	38	BBU38-140K								
200	k	38	BBU38-200K								
5	E	38	BBU38-5E	10		BBU-EFID	5E to 200E				
7	E	38	BBU38-7E								
10	E	38	BBU38-10E								
13	E	38	BBU38-13E								
15	E	38	BBU38-15E								
20	E	38	BBU38-20E								
25	E	38	BBU38-25E								
30	E	38	BBU38-30E								
40	E	38	BBU38-40E								
50	E	38	BBU38-50E								
65	E	38	BBU38-65E								
80	E	38	BBU38-80E								
100	E	38	BBU38-100E								
125	E	38	BBU38-125E								
150	E	38	BBU38-150E								
175	E	38	BBU38-175E								
200	E	38	BBU38-200E								
15	SE	38	BBU38-15SE	10		BBU-EFID	15SE to 200SE				
20	SE	38	BBU38-20SE								
25	SE	38	BBU38-25SE								
30	SE	38	BBU38-30SE								
40	SE	38	BBU38-40SE								
50	SE	38	BBU38-50SE								
65	SE	38	BBU38-65SE								
80	SE	38	BBU38-80SE								
100	SE	38	BBU38-100SE								
125	SE	38	BBU38-125SE								
150	SE	38	BBU38-150SE								
175	SE	38	BBU38-175SE								
200	SE	38	BBU38-200SE								

*Note: Muffler can be ordered separately. Order Catalog number BBU-MFLR.



E-Rated Medium Voltage Fuses: CL-14 & Bolt-In

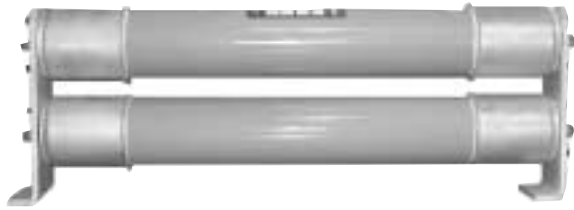

CATALOG SYMBOL: ECL055 & EBI055
E-RATED MEDIUM VOLTAGE FUSES:

Meets E requirements per ANSI C37.46

Meets General Purpose requirements per ANSI C37.40

FOR TRANSFORMER AND FEEDER PROTECTION

VOLTAGE RATING: 5.5 KV

INTERRUPTING RATING: 63KA Maximum Sym.

CURRENT LIMITING

CONSTRUCTION:

- Silver element in a double concentric helical configuration
- Silica filler
- Silver plated copper terminals and endcaps
- Filament wound, glass epoxy fuse tube

FEATURES:

- **General Purpose Fuses.** Bussmann's medium voltage fuses provide general purpose protection and are capable of interrupting fault currents up to 63,000A RMS sym.
- **Clip-lock and bolt-in style available in double and triple barrel fuse designs.**
- **Indoor and Outdoor Usage.** The filament wound, glass epoxy fuse tube provides UV and moisture protection for the fuse. This makes Bussmann's medium voltage fuses suitable for both indoor and outdoor applications.
- **Open Fuse Indication.** Indicator travel distance is 16mm.
- **Operating Frequency:** 50/60 Hz

Electrical Characteristics

Bussmann Number	Ampere Rating	Voltage	IR Max Sym.	# of Barrels	Figure #	Style
ECL055-10E	10E	5.5kV	63kA	1	1	Clip-Lock
ECL055-15E	15E	5.5kV	63kA	1	1	Clip-Lock
ECL055-20E	20E	5.5kV	63kA	1	1	Clip-Lock
ECL055-25E	25E	5.5kV	63kA	1	1	Clip-Lock
ECL055-30E	30E	5.5kV	63kA	1	1	Clip-Lock
ECL055-40E	40E	5.5kV	63kA	1	1	Clip-Lock
ECL055-50E	50E	5.5kV	63kA	1	1	Clip-Lock
ECL055-65E	65E	5.5kV	63kA	1	1	Clip-Lock
ECL055-80E	80E	5.5kV	63kA	1	1	Clip-Lock
ECL055-100E	100E	5.5kV	63kA	1	1	Clip-Lock
ECL055-125E	125E	5.5kV	63kA	1	1	Clip-Lock
ECL055-150E	150E	5.5kV	63kA	1	1	Clip-Lock
ECL055-200E	200E	5.5kV	63kA	1	2	Clip-Lock
ECL055-250E	250E	5.5kV	63kA	1	2	Clip-Lock
ECL055-300E	300E	5.5kV	63kA	2	3	Clip-Lock
ECL055-400E	400E	5.5kV	63kA	2	3	Clip-Lock
ECL055-450E	450E	5.5kV	63kA	2	3	Clip-Lock
ECL055-500E	500E	5.5kV	63kA	2	3	Clip-Lock
ECL055-600E	600E	5.5kV	63kA	2	3	Clip-Lock
EBI055-750E	750E	5.5kV	63kA	3	4	Bolt-In
EBI055-900E	900E	5.5kV	63kA	3	4	Bolt-In

Part Number Construction

	Catalog Symbol	Voltage Rating	Ampere Rating
Example	ECL	055	500E
		055 = 5.5 kV	

Catalog Number Cross Reference

Bussmann	Ferraz-Shawmut New Catalog #	Ferraz-Shawmut Old Catalog #
ECL055-10E	A055C1DORO-10E	225-007-937
ECL055-15E	A055C1DORO-15E	225-007-938
ECL055-20E	A055C1DORO-20E	225-007-939
ECL055-25E	A055C1DORO-25E	225-007-940
ECL055-30E	A055C1DORO-30E	225-007-941
ECL055-40E	A055C1DORO-40E	225-007-942
ECL055-50E	A055C1DORO-50E	225-007-943
ECL055-65E	A055C1DORO-65E	225-007-944
ECL055-80E	A055C1DORO-80E	225-007-945
ECL055-100E	A055C1DORO-100E	225-007-946
ECL055-125E	A055C1DORO-125E	225-007-947
ECL055-150E	A055C1DORO-150E	225-007-948
ECL055-200E	A055C1DORO-200E	225-007-949
ECL055-250E	A055C1DORO-250E	225-007-950
ECL055-300E	A055C1DORO-300E	225-007-951
ECL055-400E	A055C1DORO-400E	225-007-952
ECL055-450E	A055C2DORO-450E	225-007-953
ECL055-500E	A055C2DORO-500E	225-007-954
ECL055-600E	A055C2DORO-600E	225-007-955
EBI055-750E	A055B3DORO-750E	A055X750E-4
EBI055-900E	A055B3DORO-900E	A055X900E-4

Current-limiting medium voltage fuses are classified into three categories:

Full Range - defined by ANSI as "a fuse capable of interrupting all currents from the maximum rated interrupting current down to the minimum continuous current that causes melting of the fusible element(s), when the fuse is applied at the maximum ambient temperature specified by the manufacturer." It is able to interrupt any normal 60 cycle current that will melt its element.

General Purpose - defined by ANSI C37.40 as "a fuse capable of interrupting all currents from the maximum rated interrupting current down to the current that causes melting of the fusible element in one hour." Not all currents fall within this range. It is possible to receive an overcurrent lower than the value given by the one hour criterion.

Back-up - defined by ANSI C37.40 as "a fuse capable of interrupting all currents from the maximum rated interrupting current down to the rated minimum interrupting current." The minimum rated interrupting current is the lowest current that the fuse will be able to clear properly. This creates a need to place a low current interrupting device in series with the back-up rated fuse.



E-Rated Medium Voltage Fuses: CL-14



Electrical Characteristics

Bussmann Number	Ampere Rating	Voltage	IR Max Sym.	# of Barrels	Figure #	Style
ECL155-10E	10E	15.5kV	63KA	1	1	Clip-Lock
ECL155-15E	15E	15.5kV	63KA	1	1	Clip-Lock
ECL155-20E	20E	15.5kV	63KA	1	1	Clip-Lock
ECL155-25E	25E	15.5kV	63KA	1	1	Clip-Lock
ECL155-30E	30E	15.5kV	63KA	1	1	Clip-Lock
ECL155-40E	40E	15.5kV	63KA	1	1	Clip-Lock
ECL155-50E	50E	15.5kV	63KA	1	1	Clip-Lock
ECL155-65E	65E	15.5kV	63KA	1	2	Clip-Lock
ECL155-80E	80E	15.5kV	63KA	1	2	Clip-Lock
ECL155-100E	100E	15.5kV	63KA	1	2	Clip-Lock
ECL155-125E	125E	15.5kV	63KA	1	2	Clip-Lock
ECL155-150E	150E	15.5kV	63KA	2	3	Clip-Lock
ECL155-200E	200E	15.5kV	63KA	2	3	Clip-Lock
ECL155-250E	250E	15.5kV	50kA	2	3	Clip-Lock
ECL155-300E	300E	15.5kV	50kA	2	3	Clip-Lock

Part Number Construction

	Catalog Symbol	Voltage Rating	Ampere Rating
Example	ECL	155	300E
		155 = 15.5 kV	

Catalog Number Cross Reference

Bussmann	Ferraz-Shawmut New Catalog #	Ferraz-Shawmut Old Catalog #
ECL155-10E	A155C1DORO-10E	225-007-967
ECL155-15E	A155C1DORO-15E	225-007-968
ECL155-20E	A155C1DORO-20E	225-007-969
ECL155-25E	A155C1DORO-25E	225-007-970
ECL155-30E	A155C1DORO-30E	225-007-971
ECL155-40E	A155C1DORO-40E	225-007-972
ECL155-50E	A155C1DORO-50E	225-007-973
ECL155-65E	A155C1DORO-65E	225-007-974
ECL155-80E	A155C1DORO-80E	225-007-975
ECL155-100E	A155C1DORO-100E	225-007-976
ECL155-125E	A155C2DORO-125E	225-007-977
ECL155-150E	A155C3DORO-150E	225-007-978
ECL155-200E	A155C3DORO-200E	225-007-979
ECL155-250E	A155C3DORO-250E	225-007-980
ECL155-300E	A155C3DORO-300E	225-007-981

CATALOG SYMBOL: ECL155

E-RATED MEDIUM VOLTAGE FUSES:

Meets E requirements per ANSI C37.46

Meets General Purpose requirements per ANSI C37.40

FOR TRANSFORMER AND FEEDER PROTECTION

VOLTAGE RATING: 15.5 KV

INTERRUPTING RATING: See table.

CURRENT LIMITING

CONSTRUCTION:

- Silver element in a double concentric helical configuration
- Silica filler
- Silver plated copper terminals and endcaps
- Filament wound, glass epoxy fuse tube

FEATURES:

- **General Purpose Fuses.** Bussmann's medium voltage fuses provide general purpose protection and are capable of interrupting fault currents up to 50,000A RMS sym.
- **Clip-Lock Double Barrel Fuse Design.**
- **Indoor and Outdoor Usage.** The filament wound, glass epoxy fuse tube provides UV and moisture protection for the fuse. This makes Bussmann's medium voltage fuses suitable for both indoor and outdoor applications.
- **Open Fuse Indication.** Indicator travel distance is 16mm.
- **Operating Frequency:** 50/60 Hz

Current-limiting medium voltage fuses are classified into three categories:

Full Range - defined by ANSI as "a fuse capable of interrupting all currents from the maximum rated interrupting current down to the minimum continuous current that causes melting of the fusible element(s), when the fuse is applied at the maximum ambient temperature specified by the manufacturer." It is able to interrupt any normal 60 cycle current that will melt its element.

General Purpose - defined by ANSI C37.40 as "a fuse capable of interrupting all currents from the maximum rated interrupting current down to the current that causes melting of the fusible element in one hour." Not all currents fall within this range. It is possible to receive an overcurrent lower than the value given by the one hour criterion.

Back-up - defined by ANSI C37.40 as "a fuse capable of interrupting all currents from the maximum rated interrupting current down to the rated minimum interrupting current." The minimum rated interrupting current is the lowest current that the fuse will be able to clear properly. This creates a need to place a low current interrupting device in series with the back-up rated fuse.



R-Rated Fuses for Motor Circuit Protection



JCK, JCK-A, JCK-B, JCH, JCL, JCL-A, JCL-B, JCG, JCR, & JCR-B

R-Rated Medium Voltage Current Limiting

2400V AC — JCK, JCK-A, JCK-B, JCH

4800V AC — JCL, JCL-A, JCL-B, JCG

7200V AC — JCR, JCR-B

Max. Design Voltage: 2540Vac — JCK, JCK-A, JCK-B, JCH
5080Vac — JCL, JCL-A, JCL-B, JCG
8300Vac — JCR, JCR-B

Agency Information:

UL Recognized : 2540Vac — JCK, JCK-A

5080Vac — JCL, JCL-A

UL Recognized (Guide #MSSS2, File #E96676)

Dimensional Data

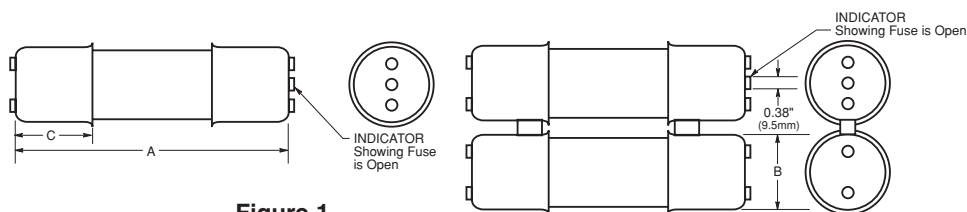

Figure 1

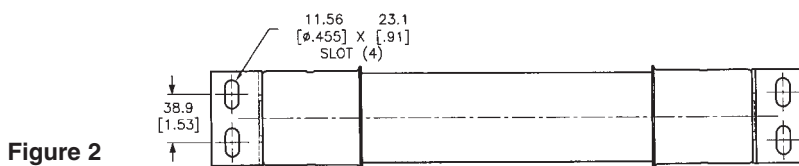
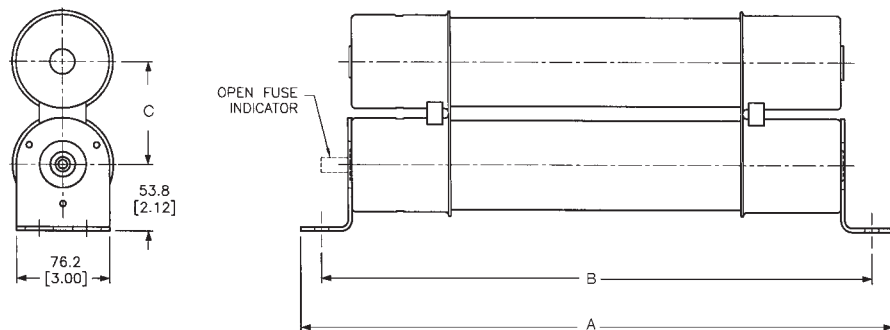
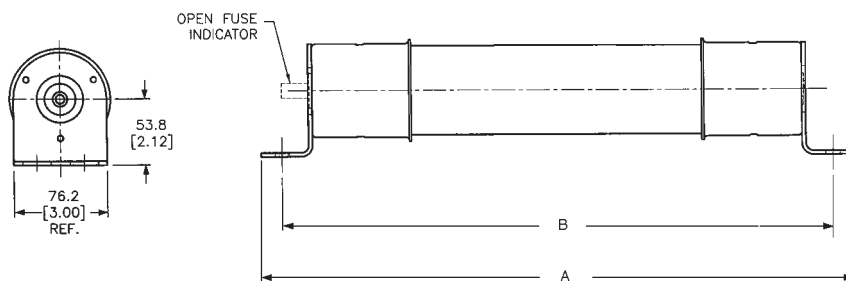

Figure 2



R-Rated Fuses for Motor Circuit Protection

Specifications

Buss Catalog No.	Amperage	Maximum Design Voltage	Dimensions (Inches)			Construction	Max. Int. Cap.		Min. Int. Cap.
			A	B	C		Amps (Asym.)	Amps (Sym.)	
2400V; R-Rated; Indoor/Enclosure (See Figure 1)									
JCK-2R	70 2R	2540V	11.24	3.0	3.0	Single	80,000	50,000	165
JCK-3R	100 3R	2540V	11.24	3.0	3.0	Single	80,000	50,000	220
JCK-4R	130 4R	2540V	11.24	3.0	3.0	Single	80,000	50,000	320
JCK-5R	150 5R	2540V	11.24	3.0	3.0	Single	80,000	50,000	410
JCK-6R	170 6R	2540V	11.24	3.0	3.0	Single	80,000	50,000	480
JCK-9R	200 9R	2540V	11.24	3.0	3.0	Single	80,000	50,000	720
JCK-12R	230 12R	2540V	11.24	3.0	3.0	Single	80,000	50,000	970
JCK-18R	390 18R	2540V	11.24	3.0	3.0	Double	80,000	50,000	1,430
JCK-24R	450 24R	2540V	11.24	3.0	3.0	Double	80,000	50,000	1,880
2400V; R-Rated; Indoor/Enclosure; With Westinghouse Ampguard Hookeye (See Figure 1)									
JCK-A-2R	70 2R	2540V	11.24	3.0	3.0	Single	80,000	50,000	165
JCK-A-3R	100 3R	2540V	11.24	3.0	3.0	Single	80,000	50,000	220
JCK-A-4R	130 4R	2540V	11.24	3.0	3.0	Single	80,000	50,000	320
JCK-A-5R	150 5R	27540V	11.24	3.0	3.0	Single	80,000	50,000	410
JCK-A-6R	170 6R	2540V	11.24	3.0	3.0	Single	80,000	50,000	480
JCK-A-9R	200 9R	2540V	11.24	3.0	3.0	Single	80,000	50,000	720
JCK-A-12R	230 12R	2540V	11.24	3.0	3.0	Single	80,000	50,000	970
JCK-A-18R	390 18R	2540V	11.24	3.0	3.0	Double	80,000	50,000	1,430
JCK-A-24R	450 24R	2540V	11.24	3.0	3.0	Double	80,000	50,000	1,880
2400V; R-Rated; Indoor/Enclosure; Bolt-On (See Figure 2)									
JCK-B-30	25	2540V	14.18	12.81	-	Single	80,000	50,000	90
JCK-B-2R	70 2R	2540V	14.18	12.81	-	Single	80,000	50,000	170
JCK-B-3R	100 3R	2540V	14.18	12.81	-	Single	80,000	50,000	245
JCK-B-4R	130 4R	2540V	14.18	12.81	-	Single	80,000	50,000	340
JCK-B-5R	150 5R	2540V	14.18	12.81	-	Single	80,000	50,000	430
JCK-B-6R	170 6R	2540V	14.18	12.81	-	Single	80,000	50,000	500
JCK-B-9R	200 9R	2540V	14.18	12.81	-	Single	80,000	50,000	1,000
JCK-B-12R	230 12R	2540V	14.18	12.81	-	Single	80,000	50,000	1,250
JCK-B-18R	390 18R	2540V	14.18	12.81	3.56	Double	80,000	50,000	1,700
JCK-B-24R	450 24R	2540V	14.18	12.81	3.56	Double	80,000	50,000	1,210
2400V; R-Rated; Indoor; Hermetically Sealed, Class 1, Group D, Div. 2, Hazardous Locations; For Use with Ampgard Motor Starters (See Figure 1)									
JCH-30	25	2540V	10.81	3.0	3.0	Single	80,000	50,000	90
JCH-2R	70 2R	2540V	10.81	3.0	3.0	Single	80,000	50,000	170
JCH-3R	100 3R	2540V	10.81	3.0	3.0	Single	80,000	50,000	245
JCH-4R	130 4R	2540V	10.81	3.0	3.0	Single	80,000	50,000	340
JCH-5R	150 5R	2540V	10.81	3.0	3.0	Single	80,000	50,000	430
JCH-6R	170 6R	2540V	10.81	3.0	3.0	Single	80,000	50,000	500
JCH-9R	200 9R	2540V	10.81	3.0	3.0	Single	80,000	50,000	1,000
JCH-12R	230 12R	2540V	10.81	3.0	3.0	Single	80,000	50,000	1,250
JCH-18R	390 18R	2540V	10.81	3.0	3.0	Double	80,000	50,000	1,700
JCH-24R	450 24R	2540V	10.81	3.0	3.0	Double	80,000	50,000	2,100
4800V; R-Rated; Indoor/Enclosure (See Figure 1)									
JCL-2R	70 2R	5080V	15.76	3.0	3.0	Single	80,000	50,000	165
JCL-3R	100 3R	5080V	15.76	3.0	3.0	Single	80,000	50,000	220
JCL-4R	130 4R	5080V	15.76	3.0	3.0	Single	80,000	50,000	320
JCL-5R	150 5R	5080V	15.76	3.0	3.0	Single	80,000	50,000	410
JCL-6R	170 6R	5080V	15.76	3.0	3.0	Single	80,000	50,000	480
JCL-9R	200 9R	5080V	15.76	3.0	3.0	Single	80,000	50,000	720
JCL-12R	230 12R	5080V	15.76	3.0	3.0	Single	80,000	50,000	970
JCL-18R	390 18R	5080V	15.76	3.0	3.0	Double	80,000	50,000	1,430
JCL-24R	450 24R	5080V	15.76	3.0	3.0	Double	80,000	50,000	1,880



R-Rated Fuses for Motor Circuit Protection

Specifications

Buss Catalog No.	Amperage	Maximum Design Voltage	Dimensions (Inches)			Construction	Max. Int. Cap.		Min. Int. Cap.
			A	B	C		Amps (Asym.)	Amps (Sym.)	Amps (Sym.)
4800V; R-Rated; Indoor/Enclosure; With Westinghouse Ampguard Hookeye (See Figure 1)									
JCL-A-2R	70 2R	5080V	15.76	3.0	3.0	Single	80,000	50,000	165
JCL-A-3R	100 3R	5080V	15.76	3.0	3.0	Single	80,000	50,000	220
JCL-A-4R	130 4R	5080V	15.76	3.0	3.0	Single	80,000	50,000	320
JCL-A-5R	150 5R	5080V	15.76	3.0	3.0	Single	80,000	50,000	410
JCL-A-6R	170 6R	5080V	15.76	3.0	3.0	Single	80,000	50,000	480
JCL-A-9R	200 9R	5080V	15.76	3.0	3.0	Single	80,000	50,000	720
JCL-A-12R	230 12R	5080V	15.76	3.0	3.0	Single	80,000	50,000	970
JCL-A-18R	390 18R	5080V	15.76	3.0	3.0	Double	80,000	50,000	1,430
JCL-A-24R	450 24R	5080V	15.76	3.0	3.0	Double	80,000	50,000	1,880
4800V; R-Rated; Indoor/Enclosure; Bolt-On (See Figure 2)									
JCL-B-30	30	5080V	19.25	17.88	-	Single	80,000	50,000	95
JCL-B-2R	70 2R	5080V	19.25	17.88	-	Single	80,000	50,000	180
JCL-B-3R	100 3R	5080V	19.25	17.88	-	Single	80,000	50,000	270
JCL-B-4R	130 4R	5080V	19.25	17.88	-	Single	80,000	50,000	350
JCL-B-5R	150 5R	5080V	19.25	17.88	-	Single	80,000	50,000	450
JCL-B-6R	170 6R	5080V	19.25	17.88	-	Single	80,000	50,000	540
JCL-B-9R	200 9R	5080V	19.25	17.88	-	Single	80,000	50,000	700
JCL-B-12R	230 12R	5080V	19.25	17.88	-	Single	80,000	50,000	1,000
JCL-B-18R	390 18R	5080V	19.25	17.88	3.31	Double	80,000	50,000	1,450
JCL-B-24R	450 24R	5080V	19.25	17.88	3.31	Double	80,000	50,000	2,000
4800V; R-Rated; Indoor; Hermetically Sealed, Class 1, Group D, Div. 2, Hazardous Locations; For Use with Ampgard Motor Starters (See Figure 1)									
JCG-30	30	5080V	15.91	3.0	3.0	Single	80,000	50,000	95
JCG-2R	70 2R	5080V	15.91	3.0	3.0	Single	80,000	50,000	180
JCG-3R	100 3R	5080V	15.91	3.0	3.0	Single	80,000	50,000	270
JCG-4R	130 4R	5080V	15.91	3.0	3.0	Single	80,000	50,000	350
JCG-5R	150 5R	5080V	15.91	3.0	3.0	Single	80,000	50,000	450
JCG-6R	170 6R	5080V	15.91	3.0	3.0	Single	80,000	50,000	540
JCG-9R	200 9R	5080V	15.91	3.0	3.0	Single	80,000	50,000	700
JCG-12R	230 12R	5080V	15.91	3.0	3.0	Single	80,000	50,000	1,000
JCG-A-18R	390 18R	5080V	15.91	3.0	3.0	Double	80,000	50,000	1,450
JCG-A-24R	450 24R	5080V	15.91	3.0	3.0	Double	80,000	50,000	2,000
7200V; R-Rated; Indoor/Enclosure; With Ampgard Hookeye (See Figure 1)									
JCR-A-2R	70 2R	8300V	15.85	3.0	3.0	Single	80,000	50,000	160
JCR-A-3R	100 3R	8300V	15.85	3.0	3.0	Single	80,000	50,000	250
JCR-A-4R	130 4R	8300V	15.85	3.0	3.0	Single	80,000	50,000	325
JCR-A-5R	150 5R	8300V	15.85	3.0	3.0	Single	80,000	50,000	390
JCR-A-6R	170 6R	8300V	15.85	3.0	3.0	Single	80,000	50,000	500
JCR-A-9R	200 9R	7200V	15.85	3.0	3.0	Single	80,000	50,000	750
JCR-A-12R	230 12R	7200V	15.85	3.0	3.0	Single	80,000	50,000	1,000
JCR-A-18R	390 18R	7200V	15.85	3.0	3.0	Double	80,000	50,000	1,450
JCR-A-24R	450 24R	7200V	15.85	3.0	3.0	Double	80,000	50,000	2,500
7200V; R-Rated; Indoor/Enclosure; Bolt-On (See Figure 2)									
JCR-B-2R	70 2R	8300V	19.25	17.88	-	Single	80,000	50,000	160
JCR-B-3R	100 3R	8300V	19.25	17.88	-	Single	80,000	50,000	250
JCR-B-4R	130 4R	8300V	19.25	17.88	-	Single	80,000	50,000	325
JCR-B-5R	150 5R	8300V	19.25	17.88	-	Single	80,000	50,000	390
JCR-B-6R	170 6R	8300V	19.25	17.88	-	Single	80,000	50,000	500
JCR-B-9R	200 9R	7200V	19.25	17.88	-	Single	80,000	50,000	750
JCR-B-12R	230 12R	7200V	19.25	17.88	-	Single	80,000	50,000	1,000
JCR-B-18R	390 18R	7200V	19.25	17.88	3.31	Double	80,000	50,000	1,450
JCR-B-24R	450 24R	7200V	19.25	17.88	3.31	Double	80,000	50,000	2,500



Medium Voltage for Motor Circuit Protection

Table of Ratings

kV	Code Reference	Breaking Capacity (kA)	Current Rating (A)	Dimensions		Dimensional Standard
				Length	Diameter	
3.6	WJON6	50	5 6.3 10 16 20 25 31.5 40 50	7.56" (192mm)	1.4" (35mm)	BS2692 (TA1) Interchangeable with GEC type K2 PA
3.6	WDOH6	50	50 63 80 100 125	7.56" (192mm)	2" (51mm)	BS 2692 (TA1) or DIN 43625
3.6	WFOH6	50	160 200	11.5" (292mm)	3" (76mm)	
3.6	WDLSJ	50	50 63 80 100 125	11.5" (292mm)	2" (51mm)	DIN 43625
3.6	WFLSJ	50	160 200	11.5" (292mm)	3" (76mm)	
3.6	WDFHO	50	50 63 80 100 125	10" (254mm)	2" (51mm)	BS 2692 (TA2)
3.6	WFFHO	50	160 200	10" (254mm)	3" (76mm)	
3.6	WKFHO	50	250 315 355 400	10" (254mm)	3" (76mm)	
5.5	VFNHA	60	2R-6R	15.86" (403mm)	3" (76mm)	
5.5	VKNHA	60	9R-24R	15.86" (403mm)	3" (76mm)	N. American Practice
7.2	WFNHO	40	25 31.5 40 50 63 80 100 125 160	15.86" (403mm)	3" (76mm)	BS2692 (TA4)
7.2	WKNHO	40	200 224 250 315	15.86" (403mm)	3" (76mm)	
7.2	WFMSJ	40	25 31.5 40 50 63 80 125 160	17.40" (442mm)	3" (76mm)	DIN 43625
7.2	WKMSJ	40	200 224 250 315 355	17.40" (442mm)	3" (76mm)	

Catalog Code:

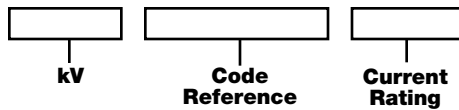

Recommended Fuse Clips for Medium Voltage Fuses

Part No.	Fuse Diameter	Clip Dimensions						
		A	B	C	D	E	F	G
A3354710	2"	3.74"	1.97"	2.00"	1.18"	4.53"	1.50"	.39"
A3354730	3"	4.13"	2.44"	3.00"	1.18"	5.63"	1.50"	.39"

Fuseclips are for single barrel applications only. Are not sold in pairs.

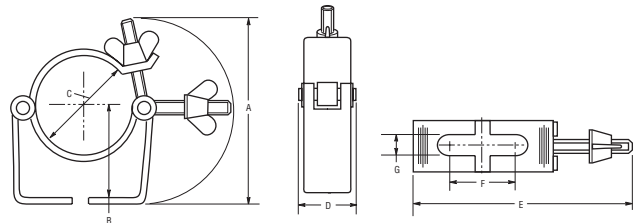

**1A0065
3" Diameter Clip**

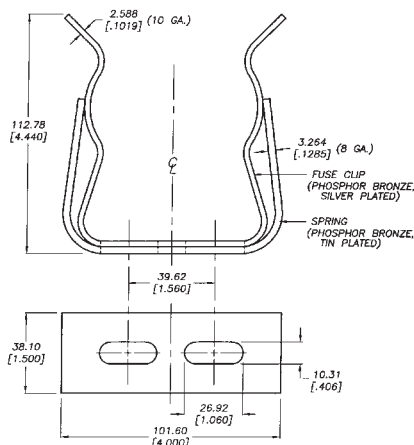

2 CLIP ASSEMBLIES PER PACKAGE.
DIMENSIONS SHOWN ARE FOR REFERENCE ONLY.

**9078A67G04
3" Diameter Clip**

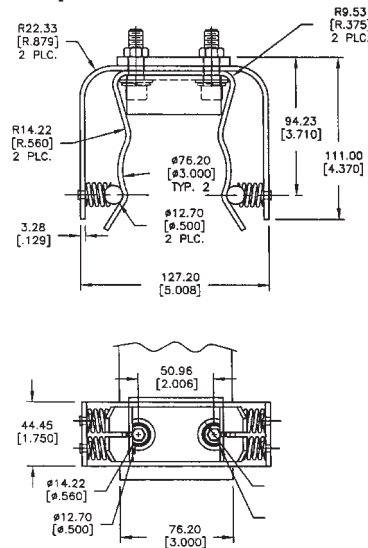

2 CUP ASSEMBLIES PER PACKAGE.
DIMENSIONS SHOWN ARE FOR REFERENCE ONLY.



E-Rated Medium Volt for Transformers and Feeders



MV055 and MV155

E-Rated Medium Voltage Fuses

Meets E requirements per ANSI C37.46

Meets full range requirements per ANSI C37.40

For Transformer and Feeder Protection

Current Limiting

Voltage Rating: 5.5 kV and 15.5 kV

Interrupting Rating: 50KA Maximum Sym.

Construction: Silver ribbon element surrounded by silica filler housed in a fiberglass tube and plated endcaps. An epoxy paint protects the fuse tube from the surrounding environment.

Electrical Characteristics 5.5kV

Part Number	Ampere Rating	Min. Melt I ² t	Max. Clear I ² t	Physical Size							
				Length	Clip Dia.	Center	Barrels				
MV055F1CAX5E	5A	180	2,400	15.75	2	12	1				
MV055F1CAX7E	7A	850	8,000								
MV055F1CAX10E	10A	850	8,000								
MV055F1CAX15E	15A	2,070	11,000								
MV055F1CAX20E	20A	2,370	23,000								
MV055F1CAX25E	25A	4,650	31,000								
MV055F1CAX30E	30A	9,490	45,000								
MV055F1CAX40E	40A	9,490	45,000								
MV055F1CAX50E	50A	13,600	90,000								
MV055F1CAX65E	65A	30,700	181,000								
MV055F1DAX10E	10A	850	8,000	15.75	3	12	1				
MV055F1DAX15E	15A	2,070	12,000								
MV055F1DAX20E	20A	2,370	23,000								
MV055F1DAX25E	25A	4,650	31,000								
MV055F1DAX30E	30A	9,490	45,000								
MV055F1DAX40E	40A	9,490	45,000								
MV055F1DAX50E	50A	13,600	90,000								
MV055F1DAX65E	65A	30,700	181,000								
MV055F1DAX80E	80A	54,600	270,000								
MV055F1DAX100E	100A	116,200	580,000								
MV055F1DAX125E	125A	167,400	600,000	15.75	3	12	1				
MV055F1DAX150E	150A	218,700	786,000								
MV055F1DAX175E	175A	227,900	1,100,000								
MV055F1DAX200E	200A	297,600	1,520,000								
MV055F2DAX250E	250A	669,600	2,400,000					15.75	3	12	2
MV055F2DAX300E	300A	874,800	3,149,000								
MV055F2DAX350E	350A	911,600	4,376,000								
MV055F2DAX400E	400A	1,190,400	6,071,000								
MV055F2DAX450E	450A	1,555,000	9,796,000								

Electrical Characteristics 15.5kV

Part Number	Ampere Rating	Min. Melt I ² t	Max. Clear I ² t	Physical Size											
				Length	Clip Dia.	Center	Barrels								
MV155F1CBX5E	5A	180	2,900	18.75	2	15	1								
MV155F1CBX7E	7A	850	8,000												
MV155F1CBX10E	10A	850	8,000												
MV155F1CBX15E	15A	2,070	12,000												
MV155F1CBX20E	20A	2,370	23,000												
MV155F1CBX25E	25A	4,650	31,000												
MV155F1CBX30E	30A	9,490	45,000												
MV155F1DBX10E	10A	850	8,000					18.75	3	15	1				
MV155F1DBX15E	15A	2,070	12,000												
MV155F1DBX20E	20A	2,370	23,000												
MV155F1DBX25E	25A	4,650	31,000												
MV155F1DBX30E	30A	9,490	45,000												
MV155F1DBX40E	40A	9,490	45,000												
MV155F1DBX50E	50A	13,600	90,000												
MV155F1DBX65E	65A	30,700	181,000												
MV155F1DBX80E	80A	54,600	270,000												
MV155F1DBX100E	100A	116,200	600,000												
MV155F2DBX125E	125A	123,000	677,000	18.75	3	15	2								
MV155F2DBX150E	150A	218,700	1,287,000												
MV155F2DBX175E	175A	314,700	1,689,000												
MV155F2DBX200E	200A	465,100	2,405,000												
MV155F1DCX65E	65A	30,700	181,000					21.75	3	18	1				
MV155F1DCX80E	80A	54,600	270,000												
MV155F1DCX100E	100A	116,200	600,000												
MV155F2DCX125E	125A	123,000	677,000									21.75	3	18	2
MV155F2DCX150E	150A	218,700	1,287,000												
MV155F2DCX175E	175A	314,700	1,689,000												
MV155F2DCX200E	200A	465,100	2,405,000												

Data Sheet: 6700

Data Sheet: 6701



E-Rated Medium Volt for Potential & Sm Power Transformers



JCD, JCW, JCE, JCQ, JCI & JCT

Current Limiting

Indicating/Non-Indicating

Plated Ferrules

Voltage Rating: (Max. Design) 2750, 5500,
8300, 15,500

Current Ratings: 1/2E through 10E

Specifications

Buss Catalog No.	Amperage	Maximum Design Voltage	Construction	Maximum Interrupting Capacity		Dimensions	
				Amps (Asym.)	Amps (Sym.)	Length	Diameter
2400V; E-Rated Fuse; Indicating							
JCD-1/2E	0.50E	2750V	Single	100,000	63,000	4.50"	.80"
JCD-1E	1.00E	2750V	Single	63,000	40,000	(114mm)	(20.32mm)
JCD-2E	2.00E	2750V	Single	63,000	40,000		
JCD-5E	5.00E	2750V	Single	40,000	25,000		
2450/5500V; E-Rated Fuse; Non-Indicating							
JCW-1/2E	0.50E	2750V/5500V	Single	60,000	40,000		
JCW-1E	1.00E	2750V/5500V	Single	60,000	40,000		
JCW-2E	2.00E	2750V/5500V	Single	60,000	40,000	7.312"	1.563"
JCW-3E	3.00E	2750V/5500V	Single	60,000	40,000	(185.72mm)	(39.70mm)
JCW-4E	4.00E	2750V/5500V	Single	60,000	40,000		
JCW-5E	5.00E	2750V/5500V	Single	60,000	40,000		
5500V; E-Rated Fuse; Non-Indicating							
JCE-1/2E	0.50E	5500V	Single	60,000	50,000		
JCE-1E	1.00E	5500V	Single	60,000	50,000		
JCE-2E	2.00E	5500V	Single	60,000	50,000	5.625"	.81"
JCE-3E	3.00E	5500V	Single	60,000	50,000	(142.88mm)	(20.32mm)
JCE-4E	4.00E	5500V	Single	60,000	50,000		
JCE-5E	5.00E	5500V	Single	60,000	50,000		
5500V; E-Rated Fuse; Indicating							
JCQ-1/2E	0.50E	5500V	Single	130,000	80,000	9.5"	
JCQ-1E	1.00E	5500V	Single	130,000	80,000	(241.3mm)	
JCQ-1 1/2E	1.50E	5500V	Single	130,000	80,000		1.6"
JCQ-3E	3.00E	5500V	Single	130,000	80,000		(40.64mm)
JCQ-5E	5.00E	5500V	Single	130,000	80,000	9.44"	
JCQ-10E	10.00E	5500V	Single	130,000	80,000	(239.78mm)	
8300V; E-Rated Fuse; Indicating							
JCI-1/2E	0.50E	8300V	Single	130,000	80,000	9.5"	
JCI-3E	3.00E	8300V	Single	130,000	80,000	(241.3mm)	
JCI-5E	5.00E	8300V	Single	130,000	80,000	12.88"	1.6"
JCI-10E	10.00E	8300V	Single	130,000	80,000	(327.15mm)	(40.64mm)
15,500V; E-Rated Fuse; Indicating							
JCT-1/2E	0.50E	15500V	Single	130,000	80,000	12.93"	
JCT-1E	1.00E	15500V	Single	130,000	80,000	(328.42mm)	
JCT-1 1/2E	1.50E	15500V	Single	130,000	80,000		1.6"
JCT-3E	3.00E	15500V	Single	130,000	80,000		(40.64mm)
JCT-5E	5.00E	15500V	Single	130,000	80,000	17.5"	
JCT-10E	10.00E	15500V	Single	130,000	80,000	(444.5mm)	

Fuse clip for 1.6" Diameter Fuses - 1A0835.

Fuse clip for .81" Diameter Fuses - 1A1837.

Data Sheet: 6002



E-Rated Fuses for Trans. & Feeder Protection



E-Rated

Current Limiting

Blown Fuse Indication

Construction: Plated Ferrules

Voltage Ratings: (Max. Design): 2,750, 5,500, 8,300, 15,500V

Current Ratings: ½E through 750E

Specifications

Buss Catalog No.	Amperage	Maximum Design Voltage	Construction	Maximum Interrupting Capacity		Dimensions			
				Amps. (Asym.)	Amps. (Sym.)	Length	Diameter		
2400V; E-Rated; Indoor/Enclosure									
JCX-½E	½E	2750V	Single	60,000	40,000	9.19" (233.38mm)	2" (50.8mm)		
JCX-1E	1E	2750V	Single	60,000	40,000				
JCX-2E	2E	2750V	Single	60,000	40,000				
JCX-3E	3E	2750V	Single	60,000	40,000				
JCX-5E	5E	2750V	Single	60,000	40,000				
JCX-7E	7E	2750V	Single	60,000	40,000				
JCX-10E	10E	2750V	Single	60,000	40,000				
JCX-15E	15E	2750V	Single	80,000	50,000	9.5"	2.1"		
JCX-20E	20E	2750V	Single	80,000	50,000				
JCX-25E	25E	2750V	Single	80,000	50,000				
JCX-30E	30E	2750V	Single	80,000	50,000				
JCX-40E	40E	2750V	Single	80,000	50,000				
JCX-50E	50E	2750V	Single	80,000	50,000				
JCX-65E	65E	2750V	Single	80,000	50,000				
JCX-80E	80E	2750V	Single	80,000	50,000				
JCX-100E	100E	2750V	Single	80,000	40,000				
JCX-125E	125E	2750V	Single	80,000	50,000				
JCX-150E	150E	2750V	Single	80,000	50,000	10.81" (276.35mm)	3" (76.2mm)		
JCX-200E	200E	2750V	Single	80,000	50,000				
JCX-225E	225E	2750V	Single	80,000	50,000				
JCX-250E/280X	250E/280X	2750V	Double	80,000	50,000				
JCX-300E/325X	300E/325X	2750V	Double	80,000	50,000				
JCX-350X	350X	2750V	Double	80,000	50,000				
JCX-400X	400X	2750V	Double	80,000	50,000				
JCX-450X	450X	2750V	Double	80,000	50,000				
5500V; E-Rated; Indoor/Enclosure									
JCY-½E	½E	5500V	Single	60,000	40,000			11.19" (284.18mm)	2" (50.8mm)
JCY-1E	1E	5500V	Single	60,000	40,000				
JCY-2E	2E	5500V	Single	60,000	40,000				
JCY-3E	3E	5500V	Single	60,000	40,000				
JCY-5E	5E	5500V	Single	60,000	40,000				
JCY-7E	7E	5500V	Single	60,000	40,000				
JCY-10E	10E	5500V	Single	60,000	40,000				
JCY-15E	15E	5500V	Single	60,000	40,000				
JCY-20E	20E	5500V	Single	60,000	40,000				
JCY-25E	25E	5500V	Single	60,000	40,000				

Contact Bussmann for the latest product information on E-Rated Fuses for Transformer and feeder protection.
Recommended Fuse Clips: 3" - 1A0065, 9078A67G04, A3354730



E-Rated Fuses for Trans. & Feeder Protection

Specifications

Buss Catalog No.	Amperage	Maximum Design Voltage	Construction	Maximum Interrupting Capacity		Dimensions			
				Amps. (Asym.)	Amps. (Sym.)	Length	Diameter		
5500V; E-Rated; Indoor/Enclosure									
JCU-10E	10E	5500V	Single	80,000	50,000	17.81" (452.4mm)	3" (76.2mm)		
JCU-15E	15E	5500V	Single	80,000	50,000	12.88" (327.0mm)	2.1" (53.34mm)		
JCU-20E	20E	5500V	Single	80,000	50,000				
JCU-25E	25E	5500V	Single	80,000	50,000	17.88" (454.15mm)	3" (76.20mm)		
JCU-30E	30E	5500V	Single	100,000	63,000				
JCU-40E	40E	5500V	Single	100,000	63,000				
JCU-50E	50E	5500V	Single	100,000	63,000				
JCU-65E	60E	5500V	Single	100,000	63,000				
JCU-80E	80E	5500V	Single	100,000	63,000				
JCU-100E	100E	5500V	Single	100,000	63,000				
JCU-125E	125E	5500V	Single	100,000	63,000				
JCU-150E	150E	5500V	Single	100,000	63,000				
JCU-175E	175E	5500V	Single	100,000	63,000				
JCU-200E	200E	5500V	Single	100,000	63,000	28.81" (731.77mm)	4" (101.60mm)		
JCU-250E	250E	5500V	Single	100,000	63,000				
JCU-300E	300E	5500V	Double	100,000	63,000				
JCU-350E	350E	5500V	Double	100,000	63,000				
JCU-400E	400E	5500V	Double	100,000	63,000				
JCU-450E	450E	5500V	Double	100,000	63,000				
JCU-600E	600E	5500V	Double*	80,000	50,000				
JCU-750E	750E	5500V	Double*	80,000	50,000				
8300V; E-Rated; Indoor/Enclosure									
JCZ-15E	15E	8300V	Single	80,000	50,000			15.51" (393.95mm)	2.1" (53.34mm)
JCZ-20E	20E	8300V	Single	80,000	50,000				
JCZ-25E	25E	8300V	Single	80,000	50,000	17.88" (454.15mm)	3" (76.2mm)		
JCZ-30E	30E	8300V	Single	80,000	50,000				
JCZ-40E	40E	8300V	Single	80,000	50,000				
JCZ-50E	50E	8300V	Single	80,000	50,000				
JCZ-65E	65E	8300V	Single	80,000	50,000				
JCZ-80E	80E	8300V	Single	80,000	50,000				
JCZ-100E	100E	8300V	Single	80,000	50,000				
JCZ-125E	125E	8300V	Single	80,000	50,000				
JCZ-150E	150E	8300V	Single	80,000	50,000				
JCZ-200E	200E	8300V	Double	80,000	50,000				
JDZ-20E	20E	8300V	Single	80,000	50,000	15.88" (403.2mm)	3" (76.2mm)		
JDZ-25E	25E	8300V	Single	80,000	50,000				
JDZ-30E	30E	8300V	Single	80,000	50,000				
JDZ-40E	40E	8300V	Single	80,000	50,000				
JDZ-50E	50E	8300V	Single	80,000	50,000				
JDZ-65E	65E	8300V	Single	80,000	50,000				
JDZ-80E	80E	8300V	Double	80,000	50,000				
JDZ-100E	100E	8300V	Double	80,000	50,000				
JDZ-125E	125E	8300V	Double	80,000	50,000				

Recommended Fuse Clips: 3" - 1A0065, 9078A67G04, A3354730

General Notes:

1. All fuses are fitted with a striker pin which can be used for indication or tripping purposes.
2. The fuses are suitable for use either indoors or outdoors.
3. These fuses are interchangeable with corresponding fuses produced by most other leading North American manufacturers.

Contact Bussmann for the latest product information on E-Rated Fuses for Transformer and feeder protection.

*Bolt on mounting



Medium Voltage DIN Distribution Fuses



DIN Dimension Fuses To Spec. DIN 43625

This product group covers current limiting fuses with dimensions to DIN 43625 and performance in compliance with IEC 282-1.

Striker Characteristics

The spring operated striker pin has a travel and energy output in compliance with the requirements of DIN 43625 and IEC 282-1.

Current Ratings

These are in accordance with the R10 and, in some cases, the R20 series of preferred numbers.

Table of Ratings and Dimensions

kV	Code Ref.	Current Rating	Dimensions Inches and mm Diameter x Length	DIN Series	IR RMS Symm
3.6	ADOSJ WDOSJ	6.3, 16, 20, 25, 31.5, 40, 50, 63, 80, 100, 125	2.00" x 7.56" 51 x 192	3.6/7.2	50KA
	WFOSJ	160, 200	3.00" x 7.56" 76 x 192		
	ADLSJ WDLSJ	6.3, 10, 16, 20, 25, 31.5, 40, 50, 63, 80, 100, 125	2.00" x 11.50" 51 x 292	10/12	
	WFLSJ WFLSJ WKLSJ WKLSJ	160 200 250 315, 400	3.00" x 11.50" 76 x 292		
7.2	SDLSJ SDLSJ	6.3, 10, 16, 20, 25, 31.5 40, 50, 63	2.00" x 11.50" 51 x 292	10/12	40KA
	SFLSJ SFLSJ SFLSJ SFLSJ	80 100 125 160	3.00" x 11.50" 76 x 292	20/24	
	WKMSJ WKMSJ	200 250, 315, 355	3.00" x 17.41" 76 x 442		
	SDLSJ SDLSJ SDLSJ	6.3, 10, 16, 20, 25 31.5, 40 50, 63	2.00" x 11.50" 51 x 292	10/12	
12	SFLSJ SFLSJ SKLSJ	63, 80 100 125, 160, 200	3.00" x 11.50" 76 x 292	10/12	50KA
	SDLSJ SDLSJ SDLSJ	6.3, 10, 16 20, 25 40	2.00" x 11.50" 51 x 292		
	SFMSJ SFMSJ	50 63, 80	3.00" x 17.41" 76 x 442		
	SDMSJ SDMSJ SDMSJ	6.3, 10, 16 20, 25, 31.5 40	2.00" x 17.41" 51 x 442		
17.5	SFMSJ SKMSJ	100 125	3.00" x 17.41" 76 x 442	20/24	25KA
	SDMSJ SDMSJ SDMSJ	6.3, 10, 16 20, 25, 31.5 40 (24kv application only)	2.00" x 17.41" 51 x 442		
	SFMSJ SFMSJ SFMSJ	40, 50 63 71 (24kv application only)	3.00" x 17.41" 76 x 442		
	SDQSJ SDQSJ	6.3, 10, 16, 20, 25, 31.5 3.15	2.00" x 21.16" 51 x 442		
36	SFQSJ	31.5, 40, 50, 56	3.00" x 21.16" 76 x 537	30/36	35.5KA

Recommended Fuseclips for DIN Style Fuses: Bussmann Part Number 270303



Potential Transformer Fuses



These are a range of fuses with low current rating, for use with voltage transformers or operating transformers to provide isolation of the associated system in the event of faults in the transformer circuit.

“AB” & “AM” Series

kV	Code Reference	Current Ratings	Type	Length	Diameter	IR
3.6	ABWNA	3.15, 6.3	AB	5.6"	1"	50KA
3.6	ABCNA	3.15, 6.3, 10	AB	7.69"	1"	
5.5	ABWNA	0.5E, 1E, 2E, 3E, 5E	AB	5.6"	1"	
5.5	AMWNA	0.5E, 1.0E, 2.0E, 3.0E, 4.0E, 5.0E	AM	5.6"	.81"	
7.2	ABWNA	3.15, 6.3	AB	5.6"	1"	45KA
7.2	ABCNA	3.15, 6.3	AB	7.69"	1"	
12.0	ABCNA	3.15	AB	7.69"	1"	
15.5	ABFNA	3.15	AB	10.00"	1"	32KA
17.5	ABGNA	3.15	AB	14.13"	1"	35KA
24.0	ABGNA	3.15	AB	14.13"	1"	25KA
36.0*	ABGNA	3.15	AB	14.13"	1"	31.5KA

Recommended fuse clip for 1" diameter fuses – A3354705.

“CAV” Series

kV	Code Reference	Current Ratings	Length	Diameter	IR
3.6	CAV	2	8.66"	1.63"	40KA
5.5	CAV	15E	7.375"		
5.5	CAVH	0.5E, 1E, 2E	7.375"		
7.2	CAV	2, 10	8.66"		
12	CAV	2	8.66"		
15.5	CAV	0.5E, 1E, 2E, 3E, 7E	12.87"		
15.5	CAVH	0.5E, 1E, 2E	12.87"		
17.5	CAV	2, 4, 6, 10	8.66"		
24	CAV	2, 3, 4	13.39"		
36	CAV	2, 4	17.32"		
36	CAVH	2	17.32"		
38	CAV	4E	17.32"		
38	CAVH	0.5E, 1E, 2E	17.32"		

*For clean indoor applications only.

Type CAVH are fitted with a striker pin for indication.

Catalog Code:

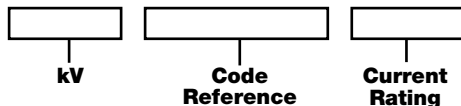

Recommended Fuse Clips: 1" dia. - A3354705
 1.63" dia. - 1A0835
 .81" dia. - 1A1837

Contact Bussmann for complete specifications on Potential Transformer Fuses



Medium Voltage, Fast Acting Fuses



HVA, HVB, HVJ, HVL, HVR, HVT, HVU, HVW & HVX

Non-Time Delay

Ampere Ratings:

Voltage Rating: 1000 to 10,000V

HVA (1000 Volts) (Max. S.C. 20KW dc, 30KVA ac)

Amps	Dia.	Length		*Wt./100		
		In.	mm	Lbs.	Kg	
1/16	3/4					
1/8	1					
1/4	1 1/2	0.41"	3"	76.1	2	0.91
1/10	2					
3/10	3					
3/10	4					
3/8	6					
1/2	10					

HVB (2500V) (Max. S.C. 20KW dc, 30KVA ac)

1/2	1 1/2	0.41"	4.5"	114.2	3	1.36
3/4	2					
1	3					

HVJ (5000V) (Max. S.C. 20KW dc, 30KVA ac)

1/16	1 1/2					
1/8	2					
1/4	4	0.81"	5"	126.9	9	4.08
1/2	6					
3/4	10					
1	—					

HVL (10,000V) (Max. S.C. 20KW dc, 30KVA ac)

1/16	1					
1/8	1 1/2	0.81"	10"	253.8	15	6.80
1/4	2					
1/2	3					

HVR (1000V) (Max. S.C. kVA-500 ac only)

1/2	3	0.41"	3"	76.1	3	1.36
1	4					
2	5					

HVW (1200V) (Max. S.C. kVA-12,000 ac only)

—	3					
1	4	0.41"	2.25"	57.1	2	0.91
2	5					
—	8					

HVT (2500V) (Max. S.C. kVA-1250 ac only)

1/2	3	0.41"	4.5"	114.2	4	1.81
1	5					
2	—					

HVU (5000V) (Max. S.C. kVA-2500 ac only)

1/2	3	0.81"	5"	126.9	19	8.62
1	4					
2	5					

HVX (10,000V) (Max. S.C. kVA-5,000 ac only)

1/2	3	0.41"	10.0"	253.8	36	16.33
1	5					

*Shipping.
Carton quantity: 10.

Test Specifications

Catalog Number	Load	Opening Time
HVA		
HVB	110%	4 Hours (min.)
HVJ	135%	1 Hour (max.)
HVL		
HVR		
HVT		
HVU	100%	4 Hours (min.)
HVW	150%	1 Hour (max.)
HVX		



4528, 4529, 4530 & 2960

Fuseblocks

Voltage Rating: 1000 to 10,000V

For Fuse Sym.	Block Cat. No.
HVA	4528
HVR	4529
HVB	4529
HVT	4529
HVJ	4530
HVU	4530
HVL	2960
HVX	2960

Use #8 screws on blocks 4528 and 4529.
Use #10 screws on blocks 4530 and 2960.



Data Sheet: 6003

For complete specification data, call Bussmann Information Fax ~ 636.527.1450

Medium Voltage — BS2692-1 Fuses

General Guide to the Selection of HV Fuse Links, used in oilfield switchgear. For use in the Primary Circuit of Three Phase 50 Hz Transformers

Transformer kVA	Transformer Primary Voltage				
	3.3kV	6.6kV	11kV		13.8kV
			ESI 12-8 Ref.	Fuse Rating	
200	3.6kV OEFMA 63	12kV OEFMA 31.5	01	12kV OEFMA 25	15.5kV OEFMA 16
250	3.6kV OEFMA 80	12kV OEFMA 40	—	12kV OEFMA 25	15.5kV OEFMA 20
300/315	3.6kV OEFMA 100	12kV OEFMA 50	02	12kV OEFMA31.5	15.5kV OEFMA 25
400	3.6kV OEFMA 125	12kV OEFMA 63	—	12kV OEFMA 40	15.5kV OEFMA 31.5
500	3.6kV OEFMA 160	12kV OHFMA 71	03	12kV OEFMA 50	15.5kV OEFMA 40
630	3.6kV OEFMA 200	7.2kV OEFMA 100	—	12kV OEFMA 63	15.5kV OEFMA 50
750/800	3.6kV OLGMA 250	7.2kV OHGMA 125	04	12kV OHFMA 80	15.5kV OEFMA 63
1000	3.6kV OLGMA 250*	7.2kV OHGMA 140	05	12kV OHGMA 90**	15.5kV OHGMA 71
1250	—	7.2kV OHGMA 160*	—	12kV OHGMA 100	15.5kV OHGMA 90
1600	—	—	—	12kV OLGMA 125*	15.5kV OLGMA 100*

This selection table has been based upon the following criteria:

1. Withstand against magnetizing inrush current taken as 12 times full-load current for 0.1 second.
2. Withstand against 150% permissible overload current. Recommendations marked with asterisks have the following significance:-
 *Limited to permissible overloads of 130%.
 **Permits use of a 12kV OHFMA 80A fuse with a 100kVA transformer where permissible overload does not exceed 130%.
3. For 6.6kV systems, 12kV fuse links are recommended where possible in the interests of standardization.
4. Wherever possible, 10 inch long FO1 fuse links are offered rather than equivalent 14 inch FO2 types.
5. The above recommendations are not generally applicable to transformers feeding motor circuits with starting currents in excess of the transformer full load current. In this event, please consult Bussmann.

Code References in Table

Letter	Reference	Explanation
1st	Type	O = Oiltight
2nd	Diameter	E, H, L = 63.5 mm
3rd	Length	F = 254 mm, G = 359 mm
4th	Striker	M = As specified in BS 2692 table 11.
5th	Tags	A = none, i.e. plain caps

Table of Preferred Ratings

Rated kV	Code Reference	Dimensional Ref. BS 2692	Current Ratings (amps)	Breaking Capacity (kA)
3.6	OEFMA	FO1	6.3, 10, 16, 20, 25, 31.5, 40, 50, 63, 80, 100, 125, 160, 200	50
3.6	OEGMA	FO2	100, 125, 160, 200	50
3.6	OLGMA	FO2	250	50
7.2	OEFMA	FO1	80, 100, 112	45
7.2	OHGMA	FO2	125, 140, 160	45
12.0	OEFMA	FO1	6.3, 10, 16, 20, 25, 31.5, 40, 50, 63	40
12.0	OHFMA	FO1	71, 80	40
12.0	OHGMA	FO2	6.3, 10, 16, 20, 25, 31.5, 40, 50, 63, 71, 80, 90, 100	40
12.0	OLGMA	FO2	125	40
15.5	OEFMA	FO1	6.3, 10, 16, 20, 25, 31.5, 40, 50, 63	40
15.5	OHGMA	FO2	71, 80, 90	40
15.5	OLGMA	FO2	100	40
17.5	OHGMA	FO2	6.3, 10, 16, 20, 25, 31.5, 40, 50, 63, 80	35
24.0	OEGMA	FO2	6.3, 10, 16, 20, 25, 31.5, 40, 50	25

Contact Bussmann for complete specifications on Medium Voltage Fuses



Medium Voltage Fuse Links



EEI-NEMA Type K and T Fuse Links

These fuse links afford effective overcurrent protection to systems and equipment. In addition to apparatus protection, they can be coordinated with other overcurrent protective devices for sectionalizing in order to isolate feeder branches.

Catalog Data-EEI-NEMA and High-Surge Universal Tin Element Fuse Links for Cutouts. Rated to 27kV

Link Amps	Type H (High Surge)	EEI-Nema Type K (Fast)	EEI-Nema Type T (Slow)	Carton Data		
				Qty.	Weight	
					Lbs.	Kg's.
Non-Removable Button-Head For Standard Open Or Enclosed Cutouts						
1	FL11H1	FL11K1	FL11T1	25	2	0.91
2	FL11H2	FL11K2	FL11T2			
3	FL11H3	FL11K3	FL11T3			
5	FL11H5	FL11K5	FL11T5			
6	—	FL11K6	FL11T6			
8	FL11H8	FL11K8	FL11T8			
10	—	FL11K10	FL11T10	25	2	0.91
12	—	FL11K12	FL11T12			
15	—	FL11K15	FL11T15			
20	—	FL11K20	FL11T20			
25	—	FL11K25	FL11T25			
30	—	FL11K30	FL11T30			
40	—	FL11K40	FL11T40	25	4	1.82
50	—	FL11K50	FL11T50			
65	—	FL11K65	FL11T65			
80	—	FL11K80	FL11T80	15	5.5	2.49
100	—	FL11K100	FL11T100			
140	—	FL11K140	FL11T140	10	7	3.17
200	—	FL11K200	FL11T200			

High-Surge Type H Fuse Links

High-surge, Type H fuse links are manufactured in ratings of 1, 2, 3, 5, and 8A. They have been developed principally for primary fusing of small-sized transformers. Type H links are manufactured in the universal buttonhead design.

Type N Fuse Links

Type N fuse links conform to previous NEMA standards and have been superseded by Type K and T links. Type N fuse links are manufactured in the universal button design in ratings of 5 through 200A for use in NEMA standard dimensioned cutouts rated through 27 kv.

Catalog Data-EEI-NEMA and High-Surge Universal Tin Element Fuse Links for Cutouts. Rated to 27kV

Link Amps	Type H (High Surge)	EEI-Nema Type K (Fast)	EEI-Nema Type T (Slow)	Carton Data		
				Qty.	Weight	
					Lbs.	Kg's.
Removable Button-Head For Cutouts Requiring Removable-Button Links*						
1	—	FL3K1	FL3T1	25	1.81	0.82
2	—	FL3K2	FL3T2			
3	—	FL3K3	FL3T3			
5	—	FL3K5	FL3T5			
6	—	FL3K6	FL3T6			
8	—	FL3K8	FL3T8			
10	—	FL3K10	FL3T10			
12	—	FL3K12	FL3T12			
15	—	FL3K15	FL3T15			
20	—	FL3K20	FL3T20			
25	—	FL3K25	FL3T25	25	3.44	1.56
30	—	FL3K30	FL3T30			
40	—	FL3K40	FL3T40			
50	—	FL3K50	FL3T50			
65	—	FL3K65	FL3T65	15	3.63	1.65
80	—	FL3K80	FL3T80			
100	—	FL3K100	FL3T100	10	7.63	3.46
140	—	FL3K140	FL3T140			
200	—	FL3K200	FL3T200			

*Adapter-type removable-button links with ferrule adapter to convert to double-leader links are available in K and T types. Order by description.

Catalog Data-EEI-NEMA Type K Universal Silver-Element Fuse Links for Cutouts Rated through 27kV

Link Rating Amps	EEI-Nema Type K	Carton Data		
		Qty.	Weight	
			Lbs.	Kg's.
Non-Removable Button-Head For Standard Open Or Enclosed Cutouts				
8	FL12K8	25	2	0.91
10	FL12K10			
12	FL12K12			
15	FL12K15			
25	FL12K25			
50	FL12K50	25	3	1.34



Page 174

BLANK

(Do NOT Print)

Telpower® Compact Fused Disconnect Switch

TPC & TPCDS

TPC & TPCDS**TPCDS** - Telpower® Compact Fused Disconnect Switch**TPC** - Telpower® Compact Fuse - Current Limiting**Ampere Ratings:** 3-125AAvailable Ratings: 3, 4, 5, 6, 7, 8, 10, 12, 15, 20, 25, 30,
40, 50, 60, 75, 90, 100, 125A**Voltage Rating:** 80Vdc**Interrupting Rating:** 100,000A**Agency Information:** CE

UL Recognized (investigated to UL 1801) as a disconnect switch for the interruption of load current by means of withdrawing the fuse pullout.

Recognized to U.S. and Canadian requirements under the component recognition program of Underwriters Laboratories Inc.

Files E219046 and E56412.

General Information:

- Fusible solution for replacement of existing DC Telecom circuit breakers.
- Compact size fused disconnect switch.
- AmpColor ID™ System for easy fuse replacement.
- Available in two disconnect switch profiles in addition to a variety of terminal styles.
- Local and remote open fuse indication.
Local alarm indication provided by LED on TPC fuse.
- Remote alarm terminal available in three positions common to DC circuit protection devices.
- Recommended .75 inch center-to-center product spacing.
- Current-limiting capability
- Complete system coordination capability.
- Highest interrupting rating (100,000A) available for DC circuit protection of this footprint.
- No venting of arc or molten metals and gases during opening.
- Fuse material: Black thermoplastic, UL rated 94 V-O, 170° C RTI.
- Housing material: Black thermoplastic, UL rated 94 V-O, 120° C RTI.

CE logo denotes compliance with European Union Low Voltage Directive (50-1000Vac, 75-1500Vdc). Refer to Data Sheet: 8002 or contact Bussmann Application Engineering for more information.

Look for Telpower® BLUE™ fuses exclusively from Cooper Bussmann.



Catalog Number	Description	Ampere Rating
TPC-3	Compact Fuse	3A
TPC-4	Compact Fuse	4A
TPC-5	Compact Fuse	5A
TPC-6	Compact Fuse	6A
TPC-7	Compact Fuse	7A
TPC-8	Compact Fuse	8A
TPC-10	Compact Fuse	10A
TPC-12	Compact Fuse	12A
TPC-15	Compact Fuse	15A
TPC-20	Compact Fuse	20A
TPC-25	Compact Fuse	25A
TPC-30	Compact Fuse	30A
TPC-40	Compact Fuse	40A
TPC-50	Compact Fuse	50A
TPC-60	Compact Fuse	60A
TPC-75	Compact Fuse	75A
TPC-90	Compact Fuse	90A
TPC-100	Compact Fuse	100A
TPC-125	Compact Fuse	125A
TPCDS-BBE-1	Compact Disconnect	3-125A
TPCDS-BBE-2	Compact Disconnect	3-125A
TPCDS-BBE-3	Compact Disconnect	3-125A
TPCDS-BBM-1	Compact Disconnect	3-125A
TPCDS-BBM-2	Compact Disconnect	3-125A
TPCDS-BBM-3	Compact Disconnect	3-125A
TPCDS-BSE-1	Compact Disconnect	3-125A
TPCDS-BSE-2	Compact Disconnect	3-125A
TPCDS-BSE-3	Compact Disconnect	3-125A
TPCDS-BSM-1	Compact Disconnect	3-125A
TPCDS-BSM-2	Compact Disconnect	3-125A
TPCDS-BSM-3	Compact Disconnect	3-125A
TPCDS-SSE-1	Compact Disconnect	3-125A
TPCDS-SSE-2	Compact Disconnect	3-125A
TPCDS-SSE-3	Compact Disconnect	3-125A
TPCDS-SSM-1	Compact Disconnect	3-125A
TPCDS-SSM-2	Compact Disconnect	3-125A
TPCDS-SSM-3	Compact Disconnect	3-125A
TPCDS-D-BC1*	Compact Disconnect	3-125A
TPCDS-D-BC2*	Compact Disconnect	3-125A
TPCDS-D-CC1*	Compact Disconnect	3-125A
TPCDS-D-SEC1*	Compact Disconnect	3-125A
TPCDS-D-SEC2*	Compact Disconnect	3-125A
TPCDS-D-SMC1*	Compact Disconnect	3-125A
TPCDS-D-SMC2*	Compact Disconnect	3-125A

*Not investigated to Canadian Requirements.

Data Sheet: 5023



For complete specification data, call Bussmann Information Fax ~ 636.527.1450

Telpower® Miniature Fused Disconnect Switch TPM & TPMDS

TPM & TPMDS

TPMDS - Telpower® Miniature Fused Disconnect Switch

TPM - Telpower® Miniature Fuse - Current Limiting

Ampere Ratings: 3-30A

Voltage Rating: 80Vdc

Interrupting Rating: 20,000A

Agency Information: CE

UL Recognized (investigated to UL 1801) as a disconnect switch for the interruption of load current by means of withdrawing the fuse pullout.

Recognized to U.S. and Canadian requirements under the component recognition program of Underwriters Laboratories Inc.

Files E219046 and E56412.

Catalog Number	Description	Ampere Rating
TPM-3	Miniature Fuse	3A
TPM-4	Miniature Fuse	4A
TPM-5	Miniature Fuse	5A
TPM-6	Miniature Fuse	6A
TPM-7	Miniature Fuse	7A
TPM-8	Miniature Fuse	8A
TPM-10	Miniature Fuse	10A
TPM-12	Miniature Fuse	12A
TPM-15	Miniature Fuse	15A
TPM-20	Miniature Fuse	20A
TPM-25	Miniature Fuse	25A
TPM-30	Miniature Fuse	30A
TPMDS-E	Miniature Disconnect, English	3-30A
TPMDS-M	Miniature Disconnect, Metric	3-30A

General Information:

- Smallest and most versatile fused disconnect switch available.
- Small size allows for assembly into 1 U (1.75 inch / 44.5 mm) panel.
- AmpColor ID™ System for easy fuse replacement.
- Switch design provides for easy panel mounting by single captive 4-40 (M3) nut and panel notch integral to switch footprint.
- Local and remote open fuse indication. Local alarm indication provided by LED on TPM fuse.
- Current-limiting capability
- Complete system coordination capability
- Load connection: 1/4 inch quick-connect or bolted connection with 10-32 (M5) captive nut.
- Line connection: 1/4 inch quick-connect or screw connection with clearance hole for #10 (M5) bolt.
- Maximum alarm circuit current: 20 mA
- Materials:
Fuse housing - black thermoplastic, UL 94 V-0, 170°C RTI
Switch housing - black thermoplastic, UL 94 V-0, 140°C RTI

CE logo denotes compliance with European Union Low Voltage Directive (50-1000Vac, 75-1500Vdc). Refer to Data Sheet: 8002 or contact Bussmann Application Engineering for more information.



TPM Alarm Schematic

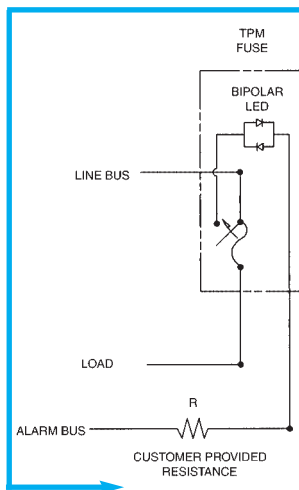

NOTES:

1. The resistance, R, must be provided by the end-user to limit the alarm output current to a maximum of 20 mA. The value, R, should be calculated using the system voltage value.
 - If remote alarm functionality is not required, the *END-USER CIRCUITRY* must still be supplied to provide a resistive path to the return for the local alarm to properly function.
2. The fuse is polarized to maintain proper orientation with the switch housing. The line and load terminals are identified on the switch housing.

Look for Telpower® BLUE™ fuses exclusively from Cooper Bussmann.



Fused Disconnect Switch



TP15914

4 Pole Disconnect Switch and TPA Series Fuses

Ampere Rating: 50A per pole

Voltage Rating: 145Vdc

Agency Information:

UL recognized as a disconnect switch for interruption of load current by means of withdrawing the fuse carrier.

UL recognized as a component for telecommunication power distribution equipment (UL category QPQYZ).

UL recognized fuses for branch circuit protection.

CSA component acceptance for the system.

Material: UL rated 94V-0, 140°C rated

Fuse

Fuse Type	TPA	TPA-B
Current	3, 5, 10, 15, 20, 25, 30, 40, 50	20, 25
Voltage	170Vdc	65Vdc
Interrupting	100 kA	20 kA

UL Recognized, Guide JFHR2, File E56412

CSA Certified, Class 1422-30, File 53787

Dimensional Data

MM
Inches

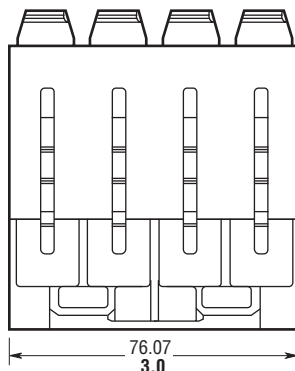

TOP

- Front access load and line connection standard—double lug load connections 8 AWG wire.
- Recognized branch circuit protection device.
- Modular design—4 poles per module up to four modules banked together.
- Ease of installation—Connection directly to bus bar.
- Reduces external wiring—per pole.
- LED alarm signaling (LED current 30mA max.).
- Blown fuse indication.
- Alarm test probe point, to allow on-site checking of alarm circuitry.
- Snap into alarm bus.
- Bi-polar LED provides capability for both -48V DC and +24V DC applications.
- Fuse presence indication.
- Fuse orientation rejection feature.
- Totally enclosed module.
- Spare fuseholders: Part No. 5TPH and TPSFH-A
- Remote alarm.
- Contact Bussmann for options on standard module (Hardware, Color, Front line connection, Mounting bezel).

CE CE logo denotes compliance with European Union Low Voltage Directive (50-1000Vac, 75-1500Vdc). Refer to Data Sheet: 8002 or contact Bussmann Application Engineering at 636-527-1270 for more information.

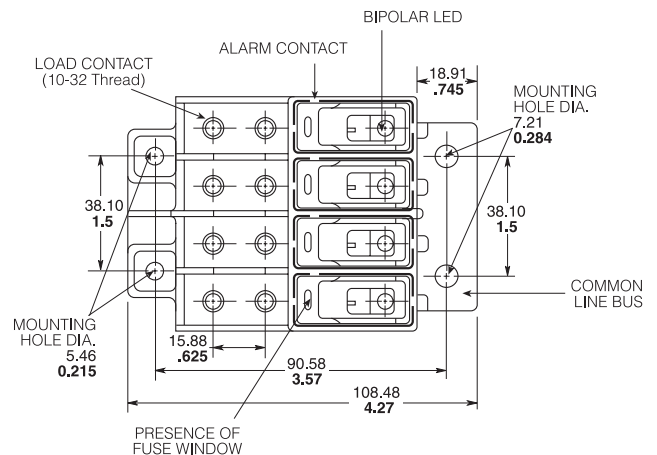

Fused Disconnect Switch & TPA Fuses



TP15900-4

4-Pole Disconnect Switch

For use with Telpower® fuses Type TPA & TPA-B.

Electrical Ratings: 40A per pole at 145Vdc
50A per pole at 80Vdc

Agency Information:

UL Recognized as a disconnect switch for interruption of load current by means of withdrawing the fuse carrier.
UL Recognized as a component for telecommunication power distribution equipment (UL category QPQY2).
UL Recognized fuses for branch circuit protection.
CSA Component Acceptance for the system.

General Information:

- Ease of installation - connection directly to bus bar.
- Reduces external wiring per pole.
- LED alarm signaling (LED current 30mA max.).
- Local and remote open-fuse indication.
- Alarm test probe point, to allow on-site checking of alarm circuitry.
- Fuse presence indication.
- Fuse orientation rejection feature.
- Rear accessibility for line and load terminations.

Material: UL rated 94V-0, 140°C rated

Catalog Numbers

TP15900-4	
TP15900-41	Split Alarm, Split Line

CE logo denotes compliance with European Union Low Voltage Directive (50-1000Vac, 75-1500Vdc). Refer to Data Sheet: 8002 or contact Bussmann Application Engineering at 636-527-1270 for more information.

Data Sheet: 5001

Dimensional Data

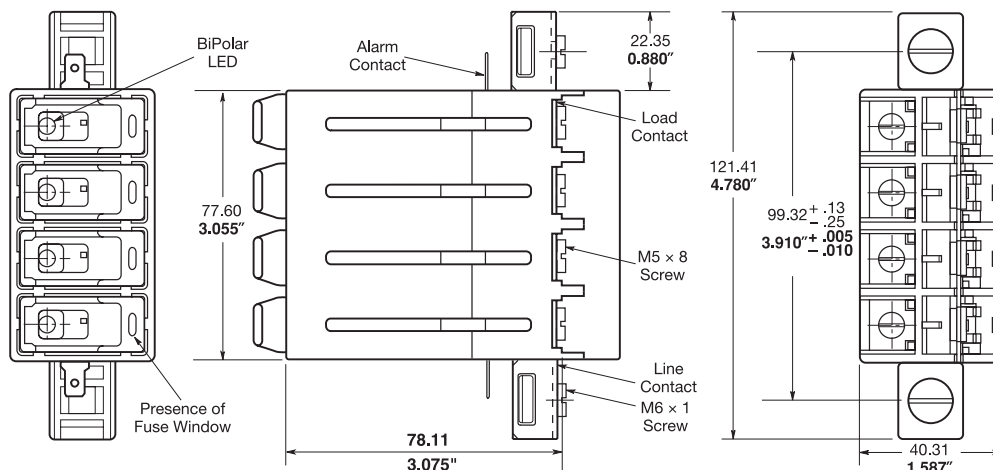

TPA & TPA-B

DC Power Distribution Indicating Fuses

Ampere Rating: TPA: 3, 5, 10, 15, 20, 25, 30, 40, 50
TPA-B: 20, 25, 30

Voltage Rating: TPA, 170 Vdc; TPA-B, 65 Vdc

Interrupting Rating: TPA, 100 kA; TPA-B, 20 kA

Agency Information:

UL Recognized, Guide JFHR2, File E56412
CSA Certified, Class 1422-30, File 53787

Construction:

- Silver-plated brass ferrules and indicator pin on TPA 3-15 and TPA-B. Tin-plated brass on TPA 20-50 on indicator end.
- Glass melamine tube.
- Spare fuseholders: 5 position holder; 5TPH; 6 position holder; TPSFH-AS

Dimensional Data

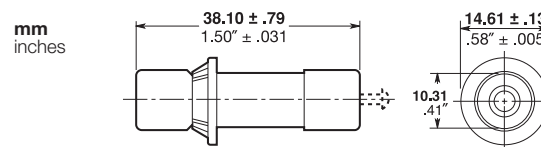

CE logo denotes compliance with European Union Low Voltage Directive (50-1000Vac, 75-1500Vdc). Refer to Data Sheet: 8002 or contact Bussmann Application Engineering at 636-527-1270 for more information.

Data Sheet: 5012



Fused Disconnect Switch



15800

Fused Disconnect Switch

Ampere Ratings: 3 to 70A.

Voltage Rating: 60Vdc

Agency Information:

UL Recognized, Guide QPQY2, File E97649

UL Withstand Rating: 100,000A,

Catalog Numbers

15800-R-200	Rear Access Panel Mounting
15800-F-200	Front Access Panel Mounting

- For use with the following fuses only:
Main: Telpower® TPS 3 to 70 Amp
Alarm: Bussmann GMT-A only (page 183).
Recommend GMT-X Cover (page 183).
- Alarm output with wire wrap terminal or connection to .063" thick common alarm bus.
- Thermoplastic housing material U.L. rated 94V-0, 150°C.
- Spare alarm and power fuse compartment.
- Mounting hardware included.
- Spare fuseholders:
for TPS fuses (TPSFH-AS);
for GMT fuses (TPSFH-T), see page 196.

CE logo denotes compliance with European Union Low Voltage Directive (50-1000Vac, 75-1500Vdc). Refer to Data Sheet: 8002 or contact Bussmann Application Engineering at 636-527-1270 for more information.

Dimensional Data

15800-R-200

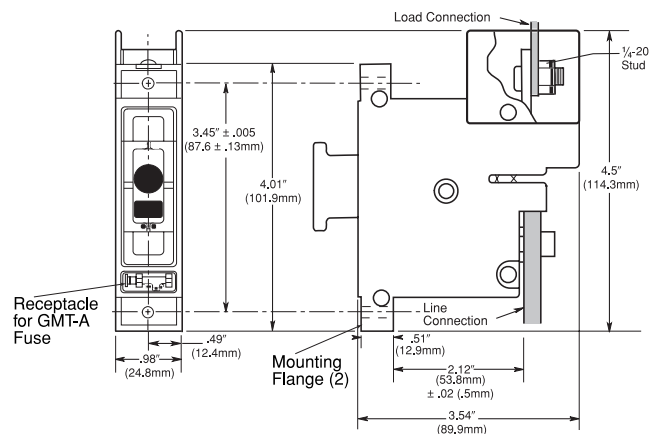

TPS

Ampere Ratings: 1 to 70A.

Voltage Rating: 170Vdc

Agency Information: CE

UL Recognized, Guide JFHR2, File E56412

Catalog Numbers

TPS-1	TPS-6L	TPS-30	TPS-50V
TPS-1L	TPS-10	TPS-30L	TPS-60
TPS-2	TPS-10L	TPS-35	TPS-60L
TPS-2L	TPS-15	TPS-35L	TPS-70
TPS-3	TPS-15L	TPS-40	TPS-70L
TPS-3L	TPS-20	TPS-40L	TPS-70LB
TPS-5	TPS-20L	TPS-40V	—
TPS-5L	TPS-25	TPS-50	—
TPS-6	TPS-25L	TPS-50L	—

Dimensional Data

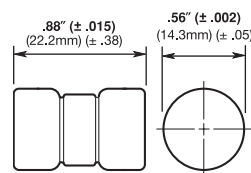

- TELPOWER fuse line is the first to be specifically designed to meet the unique needs of DC Power Distribution Systems.
- The UL Recognized ratings of 170Vdc and 100,000A interrupting rating along with the fuse's current limiting capability make this fuse ideal for cable protection on exist ing DC Distribution Systems.
- A unique BLUE label is used on all TELPOWER fuses to designate their DC capability.
- Circuit board applications available.
- Silver-plated brass ferrules.
- Glass melamine tube.
- For use with Bussmann Fused Disconnect Switch **15800**.
- Spare Fuseholder: TPSFH-AS, see page 198.
- Printed circuit board variations available.

CE logo denotes compliance with European Union Low Voltage Directive (50-1000Vac, 75-1500Vdc). Refer to Data Sheet: 8002 or contact Bussmann Application Engineering at 636-527-1270 for more information.



Data Sheet: 5002

Data Sheet: 5009

For complete specification data, call Bussmann Information Fax ~ 636.527.1450

Fused Disconnect Switch

TP158HC

TP158HC

Fused Disconnect Switch

For use with Telpower® Fuses Type TPL-B.

Ampere Ratings: 70-250A

Voltage Rating: 80Vdc

UL Withstand Rating: 100,000A

Agency Information:

UL Recognized (investigated to UL 1801) as a disconnect switch for the interruption of load current by means of withdrawing the fuse pullout.

Guide QPQY2, File E97649.

Catalog Numbers:

TP158HC: Rear Access, Panel Mounting, English

TP158HC: Rear Access, Panel Mounting, Metric



Easy Fuse Replacement

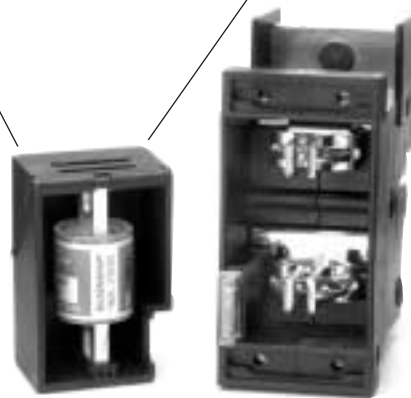

General Information:

- High amp version of Bussmann 15800 series Fused Disconnect Switch.
- Similar profile, mounting method, and backplane configuration as 15800 Series. The TP158HC can be installed into existing 15800 Series panels using the space of two 15800 disconnects.
- Innovative new fuse pullout design eliminates need for tools to replace the Telpower® type TPL-B fuse.
- For use with the following fuses only:
Main: Telpower® TPL-B 70-250 Amperes.
Alarm: Bussmann GMT-A only.
- Alarm output with wire wrap terminal or connection to .063" thick common alarm bus.
- Hardware included:
Load: washer, split lockwasher, and 5/16 – 18 nut.

- Thermoplastic housing material UL rated 94V-0, 150°C.
- Spare fuseholders:
for TPL-B fuses (TPSFH-LB), see page 14;
for GMT fuses (TPSFH-T), see page 14.
- Application Note: The line connection uses a 1/4-20 bolt (metric – M6X1) that threads into the line terminal. The line terminal is designed with a float of $\pm .02$ in. ($\pm .50$ mm) to allow for variation in the distance between the TP158HC mounting flange and the line bus bar (see dimensional data). Equipment should be designed to eliminate any relative movement between the TP158HC mounting flange and the line bus bar.
- Application Note: The alarm circuit is not intended for precharging of capacitive circuits. Alarm circuit current 1A maximum.



Fused Disconnect Switches



15100 Fused Disconnect System

For use with Telpower®
Fuses Type TPL.

Ampere Ratings: 70-800A.

Voltage Rating: 60Vdc

UL Withstand Rating: 100,000A

Agency Information:

UL Recognized, Guide QPQY2, File E97649

Catalog Numbers

15100-401	For Use With TPL series fuses	70-400A
15100-601	For Use With TPL series fuses	300-800A

CE CE logo denotes compliance with European Union Low Voltage Directive (50-1000Vac, 75-1500Vdc). Refer to Data Sheet: 8002 or contact Bussmann Application Engineering at 636-527-1270 for more information.

Dimensional Data 15100-401

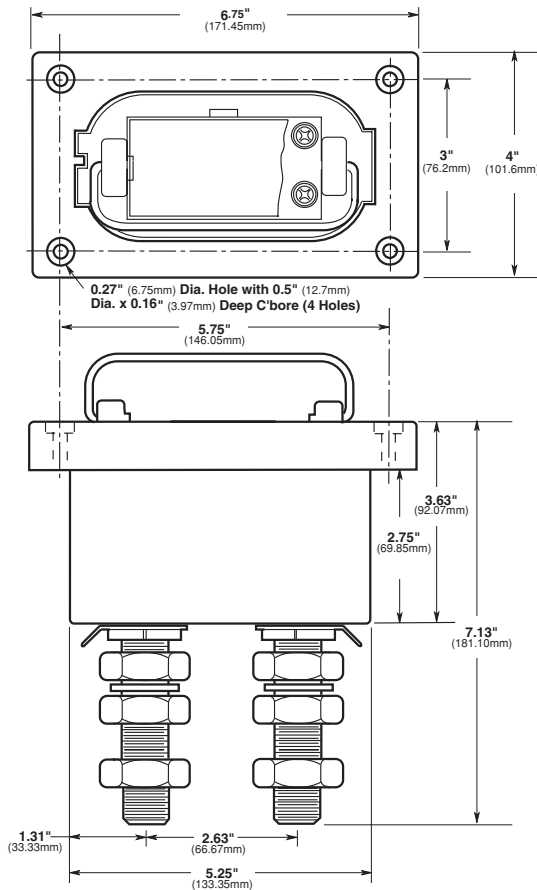

15200 Fused Disconnect System

For use with Telpower®
Fuses Type TPL.

Ampere Ratings: 70-800A

Voltage Rating: 60Vdc

UL Withstand Rating: 100,000A

Agency Information:

UL Recognized, Guide QPQY2, File E97649

Catalog Numbers

15200-602	For Use With TPL 70 to 800A
-----------	-----------------------------

CE CE logo denotes compliance with European Union Low Voltage Directive (50-1000Vac, 75-1500Vdc). Refer to Data Sheet: 8002 or contact Bussmann Application Engineering at 636-527-1270 for more information.

Dimensional Data 15200-602

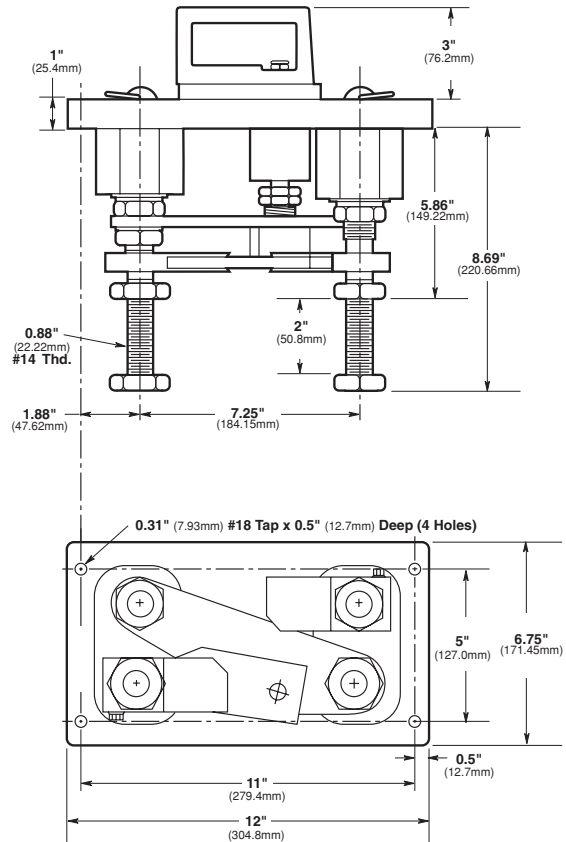

Data Sheet: 5003

Data Sheet: 5004

Telpower® High Current Switch



TPHCS800-MAV (shown)

TPHCS

Telpower® High Current Switch

For use with Telpower® Fuses Type TPL-B, TPL-C and TPH.

Ampere Ratings: 70 to 800A

Voltage Rating: 80Vdc

UL Withstand Rating: 100,000A

Agency Information:

UL Recognized (investigated to UL 1801) as a disconnect switch for the interruption of load current by means of withdrawing the fuse carrier.
UL Recognized to meet the requirements for Canadian Standards.

General Information:

- Innovative new design eliminates need for tools to replace the Telpower® type TPL-B, TPL-C or TPH fuse.
- Easy to install—captive fasteners allow for direct busbar mounting (bolts not included).
- Optional new electronic alarm provides both local and remote open-fuse indications.
 - Bipolar alarm designed for both Central Office and Radio applications.
 - Local LED alarm indication for ease-of-viewing.
 - Standard 1/4" male quick-connect terminal for effortless remote alarm connection (Maximum remote alarm current: 20mA).
 - Eliminates need for parallel indicating fuses.
- Fuse presence window allows for easy viewing of installed fuse ampere rating.
- Compact design for today's high power, high-density cabinets.
- Available as complete switch or pullout and base may be purchased separately.

TPHCS-Dimensional Data

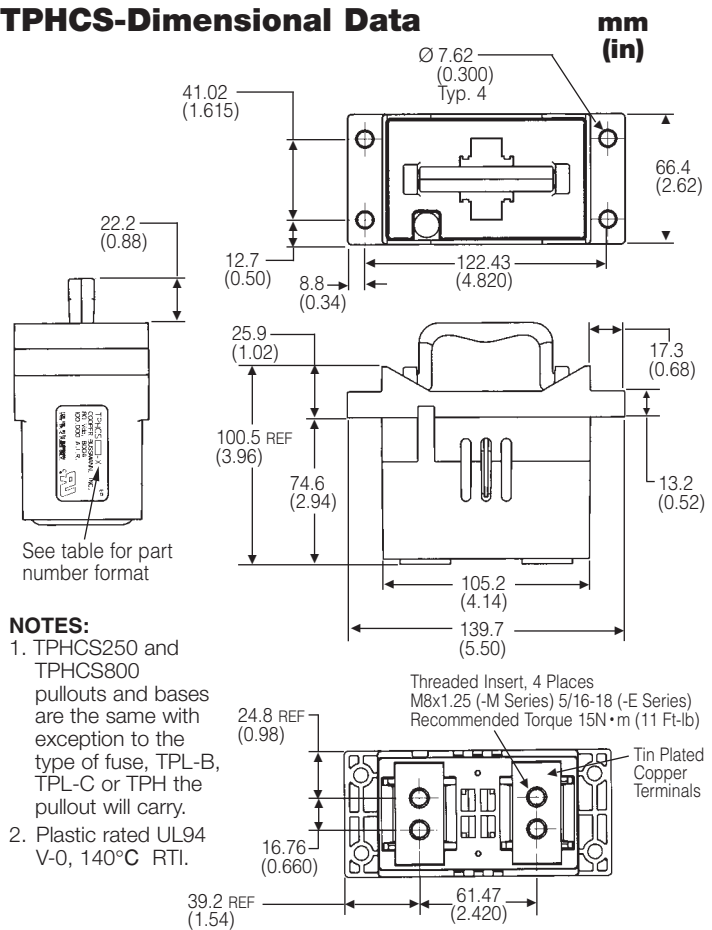

Catalog Numbers-Switches (Pullout and Base)		Series Fuse	Ampere Rating
TPHCS250-M	High Current Switch, Metric	TPL-B	70 to 250A
TPHCS250-E	High Current Switch, English	TPL-B	70 to 250A
TPHCS250-ML	High Current Switch, Metric, LED	TPL-B	70 to 25 A
TPHCS250-EL	High Current Switch, English, LED	TPL-B	70 to 250A
TPHCS250-MAV	High Current Switch, Metric, Alarm	TPL-B	70 to 250A
TPHCS250-EAV	High Current Switch, English, Alarm	TPL-B	70 to 25 A
TPHCS800-M	High Current Switch, Metric	TPL-C or TPH	300 to 800A
TPHCS800-E	High Current Switch, English	TPL-C or TPH	300 to 800A
TPHCS800-ML	High Current Switch, Metric, LED	TPL-C or TPH	300 to 800A
TPHCS800-EL	High Current Switch, English, LED	TPL-C or TPH	300 to 800A
TPHCS800-MAV	High Current Switch, Metric, Alarm	TPL-C or TPH	300 to 800A
TPHCS800-EAV	High Current Switch, English, Alarm	TPL-C or TPH	300 to 800A

Catalog Numbers – Components		Series Fuse	Ampere Rating
TPHCS250-P	Pullout only – 250 A	TPL-B	70 to 250A
TPHCS800-P	Pullout only – 800 A	TPL-C or TPH	300 to 800A
TPHCS-B-M	Base only, Metric	—	800A Max.
TPHCS-B-E	Base only, English	—	800A Max.
TPHCS-B-ML	Base only, Metric, LED	—	800A Max.
TPHCS-B-EL	Base only, English, LED	—	800A Max.
TPHCS-B-MAV	Base only, Metric, Alarm	—	800A Max.
TPHCS-B-EAV	Base only, English, Alarm	—	800A Max.



Telpower® Fuses, 70-600 Amps, 170 Volts DC



TPL

DC Power Distribution Fuses

Ampere Ratings: 70-800A

Voltage Rating: 170Vdc

Current Limiting

Interrupting Rating: 100,000A

Construction: Silver-Plated Terminals

Agency Information:

UL Recognized Guide JFHR2, File E56412
Bellcore

CE CE logo denotes compliance with European Union Low Voltage Directive (50-1000Vac, 75-1500Vdc). Refer to BIF document #8002 or contact Bussmann Application Engineering at 636-527-1270 for more information.

Ordering Information: TPL Telpower® (170Vdc)

Catalog Number	Ampere Rating	Carton Qty.	Weight*	
			Lbs.	Kg.
TPL-BA	70	5	.93	.42
TPL-BB	80	5	.93	.42
TPL-BC	90	5	.93	.42
TPL-BD	100	5	.93	.42
TPL-BE	125	5	.93	.42
TPL-BF	150	5	.93	.42
TPL-BG	175	5	.93	.42
TPL-BH	200	5	.93	.42
TPL-BK	225	5	.93	.42
TPL-BL	250	5	.93	.42
TPL-CN	300	1	.49	.22
TPL-CO	350	1	.49	.22
TPL-CR	400	1	.49	.22
TPL-CU	450	1	.49	.22
TPL-CV	500	1	.49	.22
TPL-CZ	600	1	.49	.22
TPL-CZH	800	1	.49	.22

*Weight per carton.

Dimensional Data

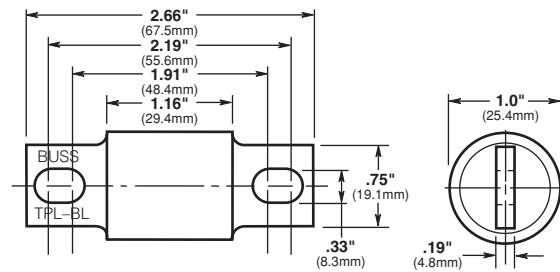

TPL-BA, TPL-BD, TPL-BE, TPL-BH, TPL-BK, AND TPL-BL

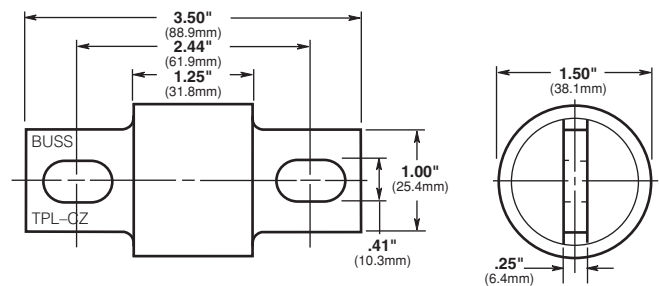

TPL-CN, TPL-CR, TPL-CV, AND TPL-CZ

- Designed for DC power distribution systems.
- Recognized branch circuit protection.
- Current-limiting capability.
- Complete system coordination capability.
- Energy savings with low watts loss, low operating temperatures, and minimum I²t levels.
- Use with Telpower **15100**, **15200**, **TP158HC** and **TPHCS** disconnect systems.
- For replacement of Bussmann's UBO fuses a TPL-TA adaptor kit is necessary.
- Spare fuseholders:
TPSFH-LB (for TPL-B fuses)
TPSFH-LC (for TPL-C fuses)



Telpower® Fuses, 1-600 Amps, 170 Volts DC



TPN

Current Limiting

DC Power Distribution Fuses

Ampere Ratings: 1-600A

Voltage Rating: 170Vdc

Interrupting Rating: 100,000A

Construction: Silver-Plated Terminals

Agency Information:

UL Recognized, Guide JFHR2, File E56412

Catalog Numbers

TPN-1	TPN-45	TPN-200
TPN-3	TPN-50	TPN-225
TPN-5	TPN-60	TPN-250
TPN-6	TPN-70	TPN-300
TPN-10	TPN-80	TPN-350
TPN-15	TPN-90	TPN-400
TPN-20	TPN-100	TPN-450
TPN-25	TPN-110	TPN-500
TPN-30	TPN-125	TPN-600
TPN-35	TPN-150	
TPN-40	TPN-175	

Carton Quantity and Weight

TPN Telpower (170Vdc)

Catalog Number	Carton Qty.	Weight*	
		Lbs.	Kg.
1-30	10	0.45	0.204
35-60	10	1.82	0.824
70-100	5	1.85	0.838
110-200	1	1.05	0.476
225-400	1	2.38	1.078
450-600	1	3.50	1.587

*Weight per carton.

- Designed for DC power distribution systems.
- The TPN series of fuses are dimensionally similar to Class R fuses.
- Recognized branch circuit protection.
- Current-limiting capability.

Data Sheet: 5006

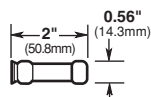

1A to 30A

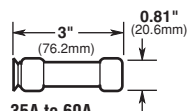

35A to 60A

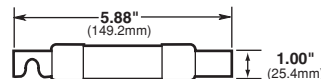

70A to 100A

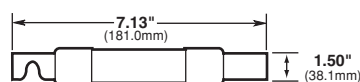

110A to 200A

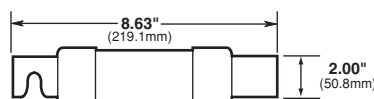

225A to 400A

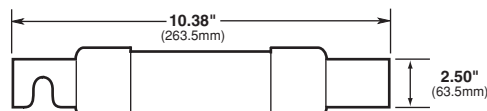

450A to 600A

Recommended Class R Fuseblocks

Amps	Poles	Catalog Number
1 to 30	1	R25030-1CR
	2	R25030-2CR
	3	R25030-3CR
35 to 60	1	R25060-1CR
	2	R25060-2CR
	3	R25060-3CR
70 to 100	1	R25100-1CR
	2	R25100-2CR
	3	R25100-3CR
110 to 200	1	R25200-1CR
	3	R25200-3CR
225 to 400	1	R25400-1CR
450 to 600	1	R25600-1CR

- Complete system coordination capability.
- Energy savings with low watts loss, low operating temperatures, and minimum I²t levels.
- Spare fuseholders:
TPSFH-N30 (for TPN 1-30)
TPSFH-N60 (for TPN 35-60)



Indicating Fuse & Holder



70 Series

Indicating Type Fuse

Voltage Rating: 125Vac; 300Vdc

Agency Information:

UL Recognized, Guide JDYX2, File E19180
Bellcore

70 Series Telpower (125Vac, 300Vdc)

Catalog Number	Ampere Rating	Voltage Rating		Color Code	Lucent Comcode	
		AC	DC		Ref. No.	Code/ List No.
70P- $\frac{1}{10}$ A*	$\frac{1}{10}$	125V	300V	Gray/Wh	100203413	KS23751-L10
70R- $\frac{1}{100}$ A*	$\frac{1}{100}$	125V	300V	Red/Wh	101384550	KS23751-L11
70E- $\frac{1}{100}$ A*	$\frac{1}{100}$	125V	300V	Yellow	100203363	KS23751-L5
70X- $\frac{2}{10}$ A	$\frac{2}{10}$	125V	300V	Black	—	—
70F- $\frac{1}{4}$ A*	$\frac{1}{4}$	125V	300V	Violet	100203371	KS23751-L6
70K- $\frac{1}{4}$ A*	$\frac{1}{4}$	125V	300V	Violet/Wh	100203405	KS23751-L9
70G- $\frac{1}{2}$ A*	$\frac{1}{2}$	125V	300V	Red	100203389	KS23751-L7
70H- $\frac{3}{4}$ A*	$\frac{3}{4}$	125V	300V	Brown	100203397	KS23751-L8
70I-1A	1	125V	300V	Pink	—	—
70A-1- $\frac{1}{2}$ A*	1 $\frac{1}{2}$	125V	300V	White	100203322	KS23751-L1
70B-2A*	2	125V	300V	Orange	100203330	KS23751-L2
70C-3A*	3	125V	300V	Blue	100203348	KS23751-L3
70J-3 $\frac{1}{2}$ A	3 $\frac{1}{2}$	125V	300V	Black/Wh	—	—
70D-5A*	5	125V	300V	Grrn/Blk	100203355	KS23751-L4
70L-6A	6	125V	300V	Grrn/Wh	—	—
70M-8A	8	125V	300V	Brown/Wh	—	—
70N-10A	10	125V	300V	Violet/Yel	—	—
GKB-10A	10	125V	300V	Violet/Yel	—	—
72A Plastic Case	Dummy	—	—	—	100203421	—
72B Blister Pack	Dummy	—	—	—	103757977	—

*Product designed to comply with Bellcore Technical Reference TR-TSY-000799 Issue 1, December 1988.

CE CE logo denotes compliance with European Union Low Voltage Directive (50-1000Vac, 75-1500Vdc). Refer to Data Sheet: 8002 or contact Bussmann Application Engineering at 636-527-1270 for more information.

15087 Fuseholder

For 70 Series Fuses

Ampere Ratings: 12A

Voltage Rating: 300Vdc

Agency Information:

UL Recognized, Guide IZLT2, File E14853

Construction:

Body: Thermoplastic, UL 94VO flammability rating

Terminals: Copper alloy, tin plating

Screws: 3-24 x $\frac{3}{8}$ " steel, zinc plated

- Panel mount fuseholder for 70 Type fuses supplied with two screws.
- Remote alarm capability.

Optional Color Code Eyelets (order separately)

Catalog Symbol	Amp Rating Ref.	Color Code	Catalog Symbol	Amp Rating Ref.	Color Code
1A1706-01	$\frac{1}{100}$	Yellow	1A1706-10	3	Blue
1A1706-02	$\frac{2}{10}$	Black	1A1706-11	5	Green/Black
1A1706-03	$\frac{1}{4}$	Violet	1A1706-12	6	Green/White
1A1706-04	$\frac{1}{4}$	Violet/White	1A1706-13	8	Brown/White
1A1706-05	$\frac{1}{2}$	Red	1A1706-14	10	Violet/Yellow
1A1706-06	$\frac{3}{4}$	Brown	1A1706-15	$\frac{1}{10}$	Gray/White
1A1706-07	1	Pink	1A1706-16	3 $\frac{1}{2}$	Black/White
1A1706-08	1 $\frac{1}{2}$	White	1A1706-17	$\frac{1}{100}$	Red/White
1A1706-09	2	Orange	—	—	—

CE CE logo denotes compliance with European Union Low Voltage Directive (50-1000Vac, 75-1500Vdc). Refer to Data Sheet: 8002 or contact Bussmann Application Engineering at 636-527-1270 for more information.



Data Sheet: 5007

Data Sheet: 5007

For complete specification data, call Bussmann Information Fax ~ 636.527.1450

185

Indicating Fuses & Holders



GMT - Dummy



GMT - A (Alarm)

GMT

Fast Acting Fuses

Voltage Rating: 60Vdc; 125Vac

Interrupting Rating: 450A, 60Vdc;
300A, 125Vac

Agency Information:

UL Recognized, Guide JFHR2, File E56412

Materials:

Body: Thermoplastic, UL 94VO flammability rating

Terminals: Tin-plated Beryllium copper

Carton Qty. and Weight: 100 Fuses per carton;
0.33 lbs. (150g)

Fuseholders: Catalog No. HLT, HLS, and PCT

Spare Fuseholder: TPSFH-T

Catalog Numbers

Catalog Symbol	Color Code	Catalog Symbol	Color Code
GMT-1 $\frac{1}{100}$ A	Yellow	GMT-3A	Blue
GMT-1 $\frac{1}{4}$ A	Violet	GMT-3 $\frac{1}{2}$ A	White/Blue
GMT-3 $\frac{1}{8}$ A	White/Gray	GMT-4A	White/Brown
GMT-1 $\frac{1}{2}$ A	Red	GMT-5A	Green
GMT-6 $\frac{1}{100}$ A	Black	GMT-7 $\frac{1}{2}$ A	Black/White
GMT-3 $\frac{1}{4}$ A	Brown	GMT-10A	Red/White
GMT-1A	Gray	GMT-12A	Yellow/Green
GMT-1 $\frac{1}{3}$ A	White	GMT-15A	Red/Blue
GMT-1 $\frac{1}{2}$ A	White/Yellow	GMT-Dummy	Gray Body
GMT-2A	Orange	GMT-X	Clear Cover

CE logo denotes compliance with European Union Low Voltage Directive (50-1000Vac, 75-1500Vdc). Refer to Data Sheet: 8002 or contact Bussmann Application Engineering at 636-527-1270 for more information.

Some GMT sizes may be sold in bulk pack only.

GMT-A

- The GMT-A is designed specifically for use in the Telpower® series 15800 Fused Disconnect Switch (page 177).
- The GMT-A has the same ratings and agency approvals as the standard GMT fuses as shown above.

Catalog Symbol	Color Code
GMT-A	Yellow

Data Sheet: 5008

HLS, HLT, PCT

Fuseholders for GMT Type Indicating Fuses

Voltage Rating: 60Vdc; 125Vac

Agency Information:

UL Recognized, Guide IZLT2, File E14853, 15A (60Vdc)

Materials:

Body: Thermoplastic, UL 94VO flammability rating

Terminals: Tin-plated copper

Multiple Fuseholders with bus bars

Ordering Information— Catalog No.

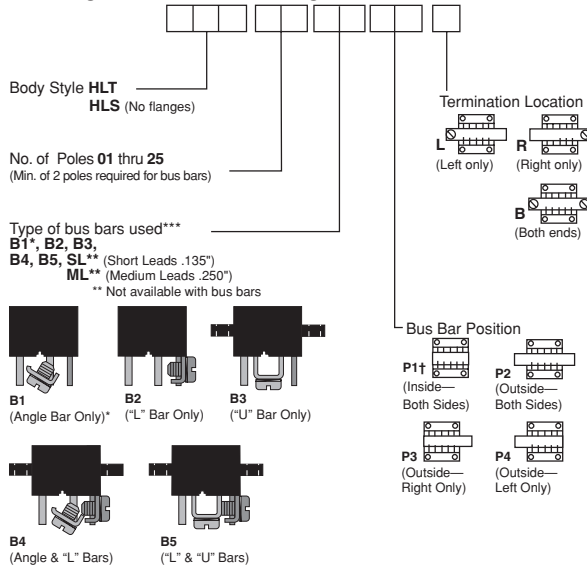

*Angle Bar mounts on common or center terminals only.

**SL Version is not available with bus bars.

†Minimum of 4 Poles Required.

***.38 max. leads if not specified.

CE logo denotes compliance with European Union Low Voltage Directive (50-1000Vac, 75-1500Vdc). Refer to Data Sheet: 8002 or contact Bussmann Application Engineering at 636-527-1270 for more information.

Data Sheet: 5010



Telpower® Specialty Fuses



Dimensional Data

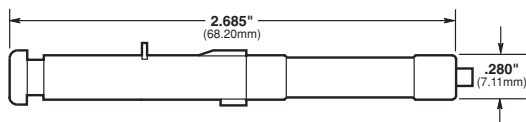

81 Type

Description: Cylindrical, fast acting, non-indicating high current companion to the 80 Type. UL Recognized, Guide JDYX2, File E19180.

Catalog Data

Catalog Symbol	Ampere Rating	Voltage ac	Rating dc	Color Code	Lucent Comcode Ref. No.	Code/ List No.
81B-7½	7.5	250V	65V	Gray	103828141	KS23824-L12
81A-10	10	250V	65V	Yellow	103752176	KS23824-L11
81C-12	12	250V	65V	Lt Blue	104391842	KS23824-L13

CE logo denotes compliance with European Union Low Voltage Directive (50-1000Vac, 75-1500Vdc). Refer to Data Sheet: 8002 or contact Bussmann Application Engineering at 636-527-1270 for more information.



Dimensional Data

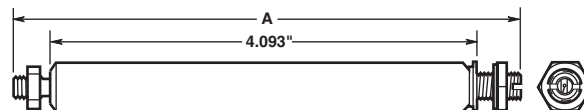

7 Type

Description: Fiber tube, threaded ends. Typically used on wall type main distribution frames and central battery substations.

Catalog Data

Catalog Symbol	Ampere Rating	Lucent Comcode Ref. No.	Dimension A Length
7 Type			
7A-7	7	100863737	4.562
7T-7	7	100202753	4.828

CE logo denotes compliance with European Union Low Voltage Directive (50-1000Vac, 75-1500Vdc). Refer to Data Sheet: 8002 or contact Bussmann Application Engineering at 636-527-1270 for more information.



Dimensional Data

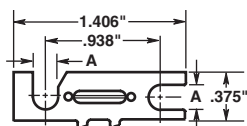

24 and WER Type

Description: Flat, nonindicating visible link element mounted on 1 inch centers using either No. 6 or No. 10 screws.

Catalog Data

Catalog Symbol	Ampere Rating	dc Volt.	Color Code	Lucent Comcode Ref. No.	Dimension A Length
WER-¼	¼	32V	—	—	—
24E-½*	½	60V	Red	100202894	.200
24D-¾*	¾	60V	Black	100202886	.150
WER-1	1	32V	—	—	—
24G-1⅓*	1⅓	60V	White	100202910	.200
24C-2*	2	60V	Orange	100202878	.200
24B-3*	3	60V	Blue	100202852	.150
WER-3½	3½	32V	—	—	—
24B-4*	4	60V	Yellow	100202860	.150
24F-5*	5	60V	Green	100202902	.150
WER-8	8	32V	—	—	—
WER-10	10	32V	—	—	—
64A-Dummy	—	—	—	100203280	—

*Designed to comply with Bellcore Technical Reference TR-TSY-000799 Issue 1, Dec. 1988.

CE logo denotes compliance with European Union Low Voltage Directive (50-1000Vac, 75-1500Vdc). Refer to Data Sheet: 8002 or contact Bussmann Application Engineering at 636-527-1270 for more information.



Dimensional Data

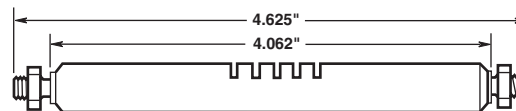

11 Type

Description: Fiber tube, threaded ends, identical to 7 Type except for vent slots in fiber tube.

Catalog Data

Catalog Symbol	Ampere Rating	Lucent Comcode Ref. No.	Dimension A Length
11 Type			
11C-7	7	100863745	—

CE logo denotes compliance with European Union Low Voltage Directive (50-1000Vac, 75-1500Vdc). Refer to Data Sheet: 8002 or contact Bussmann Application Engineering at 636-527-1270 for more information.



Telpower® Specialty Fuses



Dimensional Data

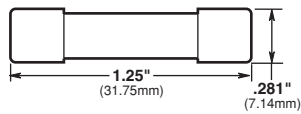

74 Type

Description: .281" × 1.25" cylindrical fuse, fast acting. Designed to comply with Lucent specification KS23753. High current companion to 70 Type Fuse.

Catalog Data

Catalog Symbol	Ampere Rating	Voltage Rating DC	Lucent Comcode Ref. No.	Code/ List No.
74A-1¼	1¼	60V	102630290	KS23753-L1
74G-2	2	60V	103064952	KS23753-L7
74B-3	3	60V	102630308	KS23753-L2
74H-4	4	60V	103264669	KS23753-L8
74C-5	5	60V	102630316	KS23753-L3
74J-7½	7½	60V	103228425	KS23753-L9
74D-10	10	60V	102630324	KS23753-L4
74E-15	15	60V	102630332	KS23753-L5
74F-20	20	60V	102630340	KS23753-L6

CE logo denotes compliance with European Union Low Voltage Directive (50-1000Vac, 75-1500Vdc). Refer to Data Sheet: 8002 or contact Bussmann Application Engineering at 636-527-1270 for more information.



Dimensional Data

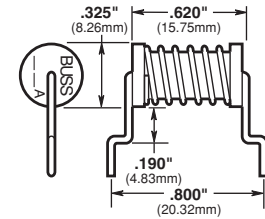

75 Type

Description: Cylindrical with leads, designed to provide protection against currents resulting from the application of foreign voltages. Application for data sets and telephones.

Catalog Data

Catalog Symbol	Ampere Rating	Voltage Rating AC	Voltage Rating DC	Lucent Comcode Ref. No.	Code/ List No.
75C	.007	135V	440V	103260816	KS23825-L3
75F	.063	135V	220V	104172861	KS23825-L6
75B	.115	135V	220V	102732112	KS23825-L2
75D	.129	135V	220V	104013180	KS23825-L4
75A	.200	135V	220V	102660008	KS23825-L1
75E	.230	135V	220V	104015292	KS23825-L5

CE logo denotes compliance with European Union Low Voltage Directive (50-1000Vac, 75-1500Vdc). Refer to Data Sheet: 8002 or contact Bussmann Application Engineering at 636-527-1270 for more information.



Dimensional Data

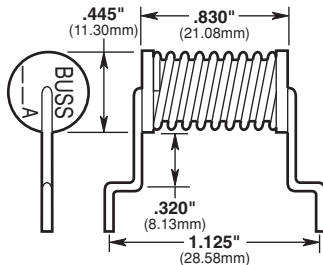

76 Type

Description: Cylindrical with leads, designed to provide protection against currents resulting from the application of foreign voltages. Application for data sets and telephones.

Catalog Data

Catalog Symbol	Ampere Rating	Voltage Rating AC	Voltage Rating DC	Lucent Comcode Ref. No.	Code/ List No.
76D	.012	135V	440V	103798245	KS23825-L10
76B	.191	135V	440V	102965688	KS23825-L8
76A	.231	135V	440V	102810181	KS23825-L7
76C	.412	135V	440V	103656625	KS23825-L9

CE logo denotes compliance with European Union Low Voltage Directive (50-1000Vac, 75-1500Vdc). Refer to Data Sheet: 8002 or contact Bussmann Application Engineering at 636-527-1270 for more information.



Dimensional Data

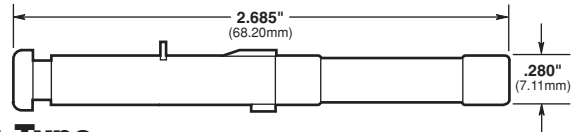

80 Type

Description: A fuse designed for high reliability applications where high ambient temperatures, low circuit voltages, low power dissipation and low contact resistance are prime considerations. The 80 Type is a visual indicating fuse with remote electrical alarm capability. UL Recognized, Guide JDYX2, File E19180.

Catalog Data

Catalog Symbol	Ampere Rating	Voltage Rating AC	Voltage Rating DC	Color Code	Lucent Comcode Ref. No.	Code/ List No.
80G-½	.50	250V	—	Red	103839916	KS23824-L6
80M-1⅓	1.33	250V	—	White	408078657	KS23824-L8
80B-2	2	250V	—	Orange	103752150	KS23824-L2
80C-3	3	250V	—	Blue	103752168	KS23824-L3
80D-5	5	250V	—	Green	103800637	KS23824-L4

CE logo denotes compliance with European Union Low Voltage Directive (50-1000Vac, 75-1500Vdc). Refer to Data Sheet: 8002 or contact Bussmann Application Engineering at 636-527-1270 for more information.



Pg 189
Do not Print

CSA Type P and Type D Fuses



CDS, CDN & PON

Voltage Ratings: 250V (CDN & PON) & 600V (CDS)

Interrupting Rating: 10kA minimum

Agency Information: CSA Certified to C22.2 No. 59.1

Time-Delay CSA Type "D"

Volts	Cat. No.	Amp Ratings	Ctn. Qty.
250V	CDN	Below 10A use FRN-R 10, 12, 15, 20, 25, 30, 35, 40, 45, 50, 60	10
		70, 80, 90, 100	5
600V	CDS	110, 125, 150, 175, 200, 225, 250, 300, 350, 400, 450, 500, 600	1
		Below 10A use FRS-R 10, 12, 15, 20, 25, 30, 35, 40, 45, 50, 60	10
600V	CDS	70, 80, 90, 100	5
		110, 125, 150, 175, 200, 225, 250, 300, 350, 400, 450, 500, 600	1

One-Time CSA Type "P"

Volts	Cat. No.	Amp Ratings	Ctn. Qty.
250V	PON	15, 20, 25, 30, 35, 40, 45, 50, 60	10

Dimensional Data

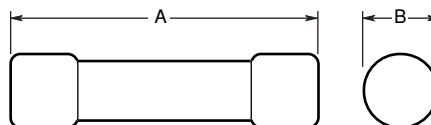

Ferrule Design 1 through 60A

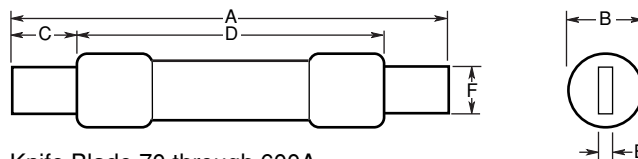

Knife Blade 70 through 600A

CE CE logo denotes compliance with European Union Low Voltage Directive (50-1000Vac, 75-1500Vdc). Refer to Data Sheet: 8002 or contact Bussmann Application Engineering at 636-527-1270 for more information.

Catalog Number and Volts	Amps	A Overall		B Maximum Diameter		C Minimum Blade Length		D Minimum Barrel Length		E Blade Thickness		F Blade Width	
		Inches	(mm)	Inches	(mm)	Inches	(mm)	Inches	(mm)	Inches	(mm)	Inches	(mm)
CDN PON 250 Vac	1-30	2.0	(50.8)	.56	(14.3)	—	—	—	—	—	—	—	—
	35-60	3.0	(76.2)	.81	(20.6)	—	—	—	—	—	—	—	—
	70-100	5.88	(149.4)	—	—	1.0	(25.4)	—	—	.13	(3.2)	.75	(19.1)
	110-200	7.3	(185.4)	—	—	1.38	(34.9)	4.13	(104.8)	.19	(4.8)	1.13	(28.6)
	225-400	8.63	(219.2)	—	—	1.88	(47.6)	4.63	(117.5)	.25	(6.4)	1.63	(41.3)
600V CDS	450-600	10.38	(263.7)	—	—	2.25	(57.2)	5.19	(131.8)	.25	(6.4)	2	(50.8)
	1-30	5.0	(127.0)	.81	(20.6)	—	—	—	—	—	—	—	—
	35-60	5.5	(139.7)	1.06	(27.0)	—	—	—	—	—	—	—	—
	70-100	7.88	(200.2)	—	—	1.0	(25.4)	—	—	.13	(3.2)	.75	(19.1)
	110-200	9.63	(244.6)	—	—	1.38	(34.9)	6.13	(115.6)	.19	(4.8)	1.13	(28.6)
600V CDS	225-400	11.63	(295.4)	—	—	1.88	(47.6)	7.13	(118.1)	.25	(6.4)	1.63	(41.3)
	450-600	13.38	(339.9)	—	—	2.25	(57.2)	8.19	(208.0)	.25	(6.4)	2	(50.8)

Data Sheet: 4126



HRC Form II Class C Fuses



CGL

Tron® HRC Form II Class C Fuses

Ampere Ratings: 2 to 600A.

Voltage Rating: 600Vac, 250Vdc (1-30A)

Interrupting Rating: 200,000A (40,000A dc)

Current Limiting

Agency Information: CSA Certified, C22.2 No. 106

- Tron® HRCII-C fuses are designed to withstand inrush currents on typical motor start-ups while offering high current limitation in the short-circuit region.
- The Tron® HRCII-C fuses can be sized close to the motor nameplate rating.
- Closer protection is offered for many motor sizes with the availability of these additional fuse ratings.
- Tron® HRCII-C fuses have a high degree of current limitation greatly reducing the magnetic forces and thermal stresses produced in today's high capacity systems.

Catalog Numbers (Ampere ratings)

CGL-1	CGL-40	CGL-175
CGL-2	CGL-45	CGL-200
CGL-3	CGL-50	CGL-225
CGL-4	CGL-60	CGL-250
CGL-6	CGL-70	CGL-300
CGL-10	CGL-80	CGL-350
CGL-15	CGL-90	CGL-400
CGL-20	CGL-100	CGL-450
CGL-25	CGL-110	CGL-500
CGL-30	CGL-125	CGL-600
CGL-35	CGL-150	—

CE logo denotes compliance with European Union Low Voltage Directive (50-1000Vac, 75-1500Vdc). Refer to Data Sheet: 8002 or contact Bussmann Application Engineering at 636-527-1270 for more information.

Dimensional Data

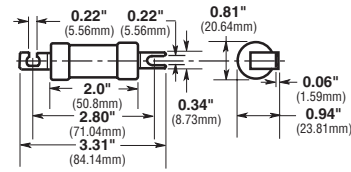

CGL 1-30

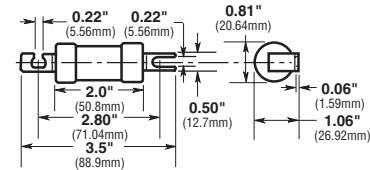

CGL 35-60

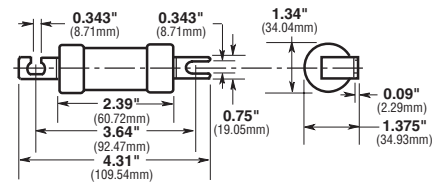

CGL 70-100

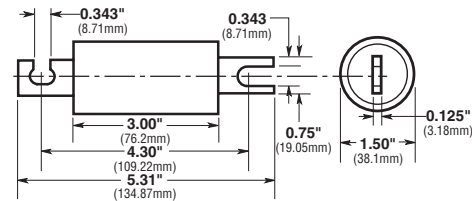

CGL 110-200

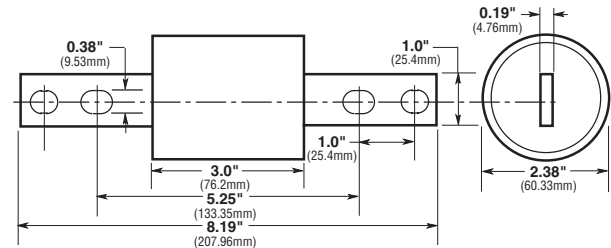

CGL 225-400

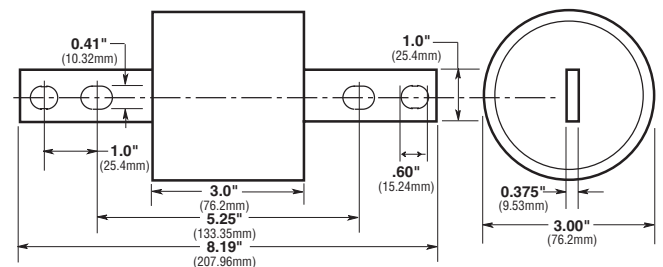

CGL 450-600



HRCI Industrial Ceramic Body Fuses



CIF21

HRCI-CA Bolt-On Mounting

Ampere Ratings: 1-30A

Voltage Rating: 600Vac; 250Vdc

Interrupting Rating: 200,000A RMS

Symmetrical

Agency Information: CSA C22.2

No. 106-M92

- Provides both overload and short-circuit protection to HRCI requirements.
- Offset blades for bolt-on mounting.
- CIF21 fuse fits the Bussmann-Camaster Fuseholder.

Dimensional Data

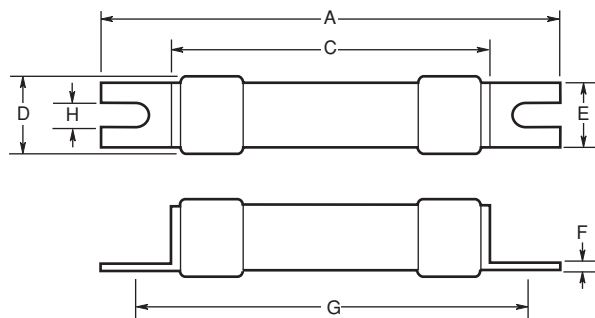

CE logo denotes compliance with European Union Low Voltage Directive (50-1000Vac, 75-1500Vdc). Refer to Data Sheet: 8002 or contact Bussmann Application Engineering at 636-527-1270 for more information.

Type	Catalog Symbol	Current Ratings	Dimensions in Inches and (mm)							
			Overall	Tags			Mounting		Body	
			A	E	F	G	H	C	D	
HRCI-CA	(AMP) CIF21	1, 3, 10, 15, 20, 25, 30	2.15 (54.50)	.44 (11.10)	.03 (0.81)	1.75 (44.50)	.19 (4.70)	1.44 (35.50)	.54 (13.80)	

Data Sheet: 4127



CIF06 & EK

HRCI-CB Clip-In Mounting

Ampere Ratings: CIF06: 1-30A, EK: 35-60A

Voltage Rating: 600Vac; 250Vdc

Interrupting Rating: 200,000A RMS Symmetrical

Agency Information: CSA C22.2 No. 106-M92

Dimensional Data

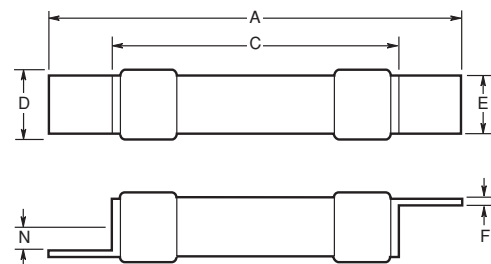

- Industrial miniature fuse with offset blades for clip-in mounting.
- Ground ceramic body with plated endcaps.
- Provides both short-circuit and overload protection.
- CIF06 fits the 30A SafeLOC fuseholder.
EK fits the 60A SafeLOC fuseholder.

CE logo denotes compliance with European Union Low Voltage Directive (50-1000Vac, 75-1500Vdc). Refer to Data Sheet: 8002 or contact Bussmann Application Engineering at 636-527-1270 for more information.

Type	Catalog Symbol	Current Ratings	Dimensions in Inches and (mm)					
			A	E	F	N	C	D
HRCI-CB	(AMP) CIF06	1, 10, 15, 20, 25, 30	2.38 (60.40)	.50 (12.70)	.03 (0.81)	.14 (3.50)	1.44 (35.50)	.54 (13.80)
	EK (AMP)	30, 35, 40, 50, 60	2.65 (67.30)	.58 (14.80)	.05 (1.22)	.14 (3.50)	1.44 (36.30)	.8 (21.40)

Data Sheet: 4128



HRCI-J Fast Acting Fuses



Dimensional Data

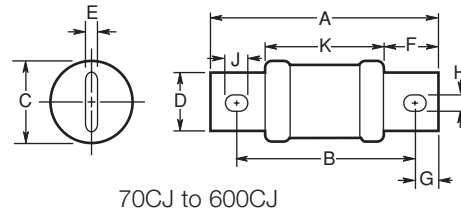
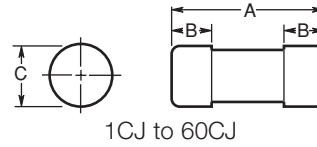

CJ

HRCI-J Fast Acting Fuses

Voltage Rating: 600Vac or less, 250Vdc

Construction: Ceramic Body Fuse

Interrupting Rating: 200,000A I.R.

Agency Information: CSA C22.2 No. 106 M92;
Designed to BS88:2, IEC 60269-2

- Industrial duty fuses with ceramic bodies.
- The excellent current limiting characteristics of fast-acting HRCI-J fuses limits damage to equipment and installations by the thermal and magnetic energy associated with a large short-circuit fault current.
- Overload characteristics limit cable damage due to low overload currents.

Current Ratings (Amps)	Catalog Number	Dimensions in Inches and (mm)									
		A	B	C	D	E	F	G	H	J	K
1	1CJ										
3	3CJ										
6	6CJ										
10	10CJ	2.25	.5	.81	—	—	—	—	—	—	—
15	15CJ	(57)	(12.7)	(20.6)							
20	20CJ										
25	25CJ										
30	30CJ										
35	35CJ										
40	40CJ	2.38	.63	1.06	—	—	—	—	—	—	—
45	45CJ	(60)	(16)	(27)							
50	50CJ										
60	60CJ										
70	70CJ	4.63	3.63	1.13	.75	.13	1	.5	.28	.38	2.63
80	80CJ	(117)	(92)	(28)	(19)	(3.2)	(25.4)	(12.7)	(7.1)	(9.5)	(67)
90	90CJ										
100	100CJ										
110	110CJ	5.75	4.38	1.63	1.13	.19	1.38	.69	.28	.38	3
125	125CJ	(146)	(111)	(41)	(28.6)	(4.8)	(35)	(17.5)	(7.1)	(9.5)	(76)
150	150CJ										
175	175CJ										
200	200CJ										
225	225CJ	7.13	5.25	2.13	1.63	.25	1.88	.94	.41	.53	3.38
250	250CJ	(181)	(133)	(54)	(41)	(6.3)	(47.6)	(24)	(10.3)	(13.5)	(86)
300	300CJ										
350	350CJ										
400	400CJ										
450	450CJ	8	6	2.63	2	.38	2.13	1	.53	.69	3.75
500	500CJ	(203)	(152)	(66)	(51)	(9.5)	(54)	(25.4)	(13.5)	(17.5)	(96)
600	600CJ										



HRCI-Misc. Type K Fuses



CIH, CIK & CIL

HRI Ceramic Body Fuses

Ampere Ratings: 30, 60 & 100A

Voltage Rating: 600V

Interrupting Rating: 200,000A at 600V

Agency Information: CSA C22.2 No. 106 M92

- Offset blades for bolt down mounting.
- Provides both overload and short-circuit protection.

CE logo denotes compliance with European Union Low Voltage Directive (50-1000Vac, 75-1500Vdc). Refer to Data Sheet: 8002 or contact Bussmann Application Engineering at 636-527-1270 for more information.

Dimensional Data

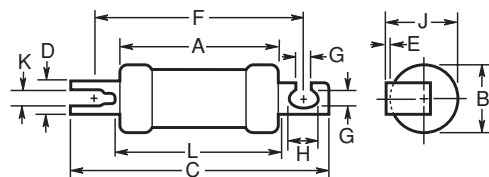

(The CIL14 has a rejection hole, not a slot as shown above.)

Ratings, Categories and Dimensions

Current Ratings (Amps)	Catalog Number	Dimensions in Inches and (mm)										
		A	B	C	D	E	F	G	H	J	K	L
		Max.	Max.	Max.	Nom.	Nom.	Nom.	Nom.	Nom.	Max.	Nom.	Max.
1	1CIH07											
3	3CIH07											
6	6CIH07											
10	10CIH07	2.25	.94	3.38	.38	.04	2.88	.21	.31	1	.10	2.38
15	15CIH07	(57)	(24)	(86)	(9.2)	(1.0)	(73)	(5.2)	(8)	(25.4)	(2.6)	(60)
20	20CIH07											
25	25CIH07											
30	30CIH07											
35	35CIK07											
40	40CIK07	2.28	1.06	3.56	.5	.05	2.88	.21	.41	1.09	.13	2.38
50	50CIK07	(58)	(27)	(91)	(12.7)	(1.2)	(73)	(5.2)	(10.5)	(28)	(3.2)	(61)
60	60CIK07											
80	80CIL14	2.75	1.44	4.38	.75	.09	3.69	.34	.41	1.5	—	2.91
90	90CIL14	(70)	(37)	(111)	(19)	(2.5)	(94)	(8.7)	(10.5)	(38.5)	—	(74)
100	100CIL14											

Recommended Fuseholders

Fuse	Fuseholder
1-30A	CM30CF
35-60A	CM60CF
80-100A	CM100CF



HRC Form II Current Limiting Fuses



Dimensional Data

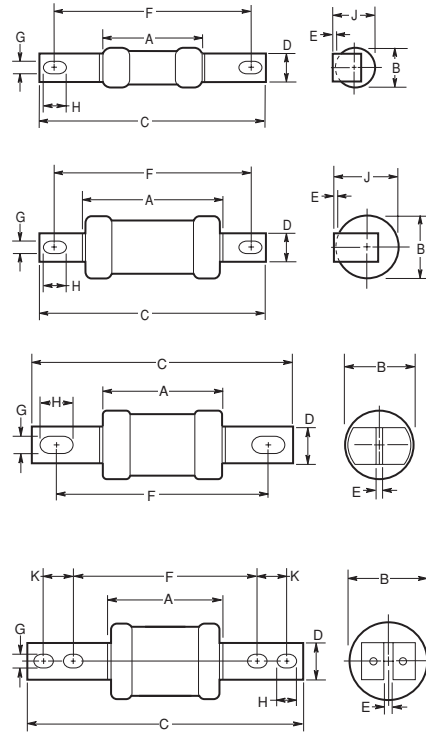

H07C (Offset Blades)

K07C/K07CR/
L14C/M14C
(Offset Blades)

L09C/M09C/P09C
(Center Blades)

P11C/R11C
(Center Blades)

HRC Form II Current Limiting Fuses

Voltage Rating: 600Vac or less, 250Vdc

Construction: Ceramic Body

Interrupting Rating: 200,000A RMS Symmetrical

Agency Information:

CSA C22.2 No.106M1992; BS88:2, IEC269:2

Applications

- HRC FORM II fuses are often used to protect motor control circuits, together with contactors and overload protection relays.
- Type 2 coordination - per IEC 947-4.

CE logo denotes compliance with European Union Low Voltage Directive (50-1000Vac, 75-1500Vdc). Refer to Data Sheet: 8002 or contact Bussmann Application Engineering at 636-527-1270 for more information.

Current Ratings (Amps)	Catalog Number	Dimensions in Inches and (mm)										CSA Category			
		A	B	C	D	E	F	G	H	J	K				
2 4 6	2H07C 4H07C 6H07C														
10 15 20 25 30	10H07C 15H07C 20H07C 25H07C 30H07C	1.38 (35)	.56 (14)	3.38 (85)	.38 (9)	.06 (1.2)	2.88 (73)	.22 (5.6)	.31 (8)	.56 (14)	—	—		HRCII-C	
40 50 60	40K07C 50K07C 60K07C	2.19 (56)	.88 (22)	3.44 (87)	.5 (13)	.06 (1.2)	2.88 (73)	.22 (5.6)	.31 (8)	.88 (22)	—	—		HRCII-C	
80 100	80K07CR 100K07CR	2.19 (56)	.88 (22)	3.75 (95)	.5 (13)	.06 (1.2)	2.88 (73)	.22 (5.6)	.31 (8)	.88 (22)	—	—		HRCII-MISC	
80 100	80L14C 100L14C	2.38 (60)	.88 (21.4)	4.38 (111)	.56 (14.3)	.13 (3.2)	3.69 (94)	.34 (8.7)	.44 (11)	1 (25.4)	—	—		HRCII-C	
125 150 200	125M14C 150M14C 200M14C	2.56 (65)	1.5 (38)	4.38 (111)	.75 (19)	.09 (2.4)	3.69 (94)	.34 (8.7)	.44 (11)	—	—	—		HRCII-MISC	
80 100	80L09C 100L09C	2.38 (60)	.88 (21.4)	5 (127)	.56 (14)	.13 (3.2)	4.38 (111)	.34 (8.7)	.44 (11)	—	—	—		HRCII-MISC	
125 150 200	125M09C 150M09C 200M09C	2.56 (65)	1.5 (38)	5.38 (136)	.75 (19)	.13 (3.2)	4.38 (111)	.34 (8.7)	.56 (14)	—	—	—		HRCII-C	
250 300 350 400	250P09C 300P09C 350P09C 400P09C	3.06 (78)	2.31 (59)	5.38 (136)	1 (25.4)	.19 (4.8)	4.38 (111)	.34 (8.7)	.5 (13)	—	—	—		HRCII-MISC	
250 300 350 400	250P11C 300P11C 350P11C 400P11C	3.06 (78)	2.31 (59)	8.25 (210)	1 (25.4)	.19 (5)	5.25 (133)	.41 (10)	.63 (16)	—	—	1 25		HRCII-C	
450 500 600	450R11C 500R11C 600R11C	3.19 (81)	2.88 (73)	8.25 (210)	1 (25.4)	.25 (6.3)	5.25 (133)	.41 (10)	.63 (16)	—	—	1 25		HRCII-C	



BS88 British Standard Low Voltage Fuses



SSD, NSD, ESD

Offset Blades

Meets the requirements of BS88 Part 1 and IEC269-1. The NSD and ESD fuses comply with general purpose gG characteristics.

Catalog No.	Ampere Ratings	Maximum Voltage Rating		BS88 Ref.	Data Sheet			
		ac	dc					
SSD	2, 4, 6, 10, 16, 20, 25, 32	240	—	E1	4105			
NSD	2, 4, 6, 10, 16, 20, 25, 32	550	—	F1	4100			
	20M25*, 20M32*					415	—	—
	20M36*, 32M36*, 32M40*, 32M50*, 32M63*					415	—	—
ESD	2, 4, 6, 10, 16, 25, 32	550	250	F2	4101			
	40, 50, 63	415	250	F2				
	63M80, 63M100	415	—	—				

*"M" indicates motor starter ratings.

Recommended Fuseholders

NSD	32NNSF
ESD	63ENSF

CE CE logo denotes compliance with European Union Low Voltage Directive (50-1000Vac, 75-1500Vdc). Refer to Data Sheet: 8002 or contact Bussmann Application Engineering at 636-527-1270 for more information.

STD, NITD, AAO, BAO, OSD, CEO, DEO

Offset Bolted Blades

Meets the requirements of BS88 Part 1 and IEC269-1. The NITD to DEO types comply with general purpose gG characteristics. The STD type are used in 240V street lighting cut-outs.

Catalog No.	Ampere Ratings	Maximum Voltage Rating		BS88 Ref.	Data Sheet
		ac	dc		
STD	2, 4, 6, 10, 16, 20, 25, 32	240	—	—	4123
NITD	2, 4, 6, 10, 16, 20	550	—	A1	4106
	25, 32	550	—	—	
	20M25*, 20M32*	550	—	A1	
	32M40*, 32M50*, 32M63*	415	—	—	
AAO	2, 4, 6, 10, 16, 20, 25, 32	550	—	A2	4109
	32M40*, 32M50*, 32M63*	550	—	A2	
BAO	40, 50, 63	550	—	A3	4112
	63M80*, 63M100*	550	—	A3	
OSD	80, 100	550	—	—	4107
	100M125*, 100M160*	415	—	—	
CEO	32, 40, 50, 63, 80, 100	550	—	A4	4115
	100M125*, 100M160*	415	—	A4	
	100M200*	415	—	A4	
DEO	125, 160, 200	415	—	—	4117
	200M250*, 200M315*	415	—	—	

*"M" indicates motor starter ratings.

Recommended Fuseblock & Holders

NITD	CM32FC
AAO	CM32F
BAO	CM63F
OSD	CM100F
CEO	BH-0111

CE CE logo denotes compliance with European Union Low Voltage Directive (50-1000Vac, 75-1500Vdc). Refer to Data Sheet: 8002 or contact Bussmann Application Engineering at 636-527-1270 for more information.



BS88 British Standard Low Voltage Fuses



AC, AD, BC, BD, CD, DD, ED, EFS Center Bolted Blades, Two Hole Mount

Meets the requirements of BS88 Parts 1 and 2 and IEC269-1. Complies with general purpose gG characteristics and available up to 400A with two hole mount and up to 1250A with four hole mount.

Catalog No.	Ampere Ratings	Maximum Voltage Rating		BS88 Ref.	Data Sheet
		ac	dc		
AC	2, 4, 6, 10, 16, 20, 25, 32	550	250	—	4110
AD	2, 4, 6, 10, 16, 20, 25, 32	550	250	—	4111
BC	40, 50, 63	550	250	—	4113
	63M80*, 63M100*	550	—	—	
BD	40, 50, 63	550	250	—	4114
CD	80, 100	550	—	B1	4116
	100M125*, 100M160*	415	—	B1	
	100M200*	415	—	B1	
DD	125, 160, 200	415	—	B2	4118
	200M250*, 200M315*	415	—	B2	
ED	250	415	—	B3	4119
	315	415	—	B3	
	315M400*	415	—	B3	
	355, 400	415	—	B4	
	400M500*	550	—	B4	
EFS	125, 160, 200, 250	415	—	—	4121
	315	415	—	—	

*"M" indicates motor starter ratings.

Recommended Fuseblock/Holder

AC	BH-0111 Modular Fuseblock
AD	200DF Fuseholder
BC	BH-0111 Modular Fuseblock
BD	200DF Fuseholder
CD	200DF Fuseholder
DD	200DF Fuseholder
ED	BH-1131 Modular Fuseblock

CE logo denotes compliance with European Union Low Voltage Directive (50-1000Vac, 75-1500Vdc). Refer to Data Sheet: 8002 or contact Bussmann Application Engineering at 636-527-1270 for more information.



EF, FF, FG, GF, GG, GH Center Bolted Blades, Four Hole Mount

Meets the requirements of BS88 Parts 1 and 2 and IEC269-1. Complies with general purpose gG characteristics and available up to 400A with two hole mount and up to 1250A with four hole mount.

Catalog No.	Ampere Ratings	Maximum Voltage Rating		BS88 Ref.	Data Sheet
		ac	dc		
EF	355, 400	415	—	C1	4120
	400M500*	550	—	C1	
FF	450, 500, 560, 630	550	400	C2	4102
FG	450, 500, 560, 630	550	400	—	4122
GF	710, 800	550	250	C3	4103
GG	710, 800	550	250	—	4104
	1000, 1250	550	—	—	
GH	710, 800	550	250	D1	4108
	1000, 1250	550	—	D1	

*"M" indicates motor starter ratings.

CE logo denotes compliance with European Union Low Voltage Directive (50-1000Vac, 75-1500Vdc). Refer to Data Sheet: 8002 or contact Bussmann Application Engineering at 636-527-1270 for more information.



DIN Style Type D and Neozed Low Voltage Fuses



Type D Fuse

Ampere Ratings: 2 to 100A.

Voltage Ratings: 500Vac

Interrupting Rating: 100kA

Agency Information:

"D" type fuses complying with DIN 49360 Part 2 and DIN 49515, operating class gL

CE CE logo denotes compliance with European Union Low Voltage Directive (50-1000Vac, 75-1500Vdc). Refer to Data Sheet: 8002 or contact Bussmann Application Engineering at 636-527-1270 for more information.

Catalog Number	Dimension "D"	Ampere Rating	Color Code	Figure Number
2D16	6	2	Pink	1
4D16	6	4	Brown	
6D16	6	6	Green	
10D16	7	10	Red	
16D16	10	16	Grey	
20D16	12	20	Blue	2
25D16	14	25	Yellow	
2D27	6	2	Pink	
4D27	6	4	Brown	
6D27	6	6	Green	
10D27	8	10	Red	3
16D27	10	16	Grey	
20D27	12	20	Blue	
25D27	14	25	Yellow	
35D33	16	35	Black	
50D33	18	50	White	4
63D33	20	63	Copper	
80D125	5	80	Silver	
100D125	7	100	Red	

Additional Fuselinks: Quick acting fuselinks in body sized D16, D27, D33 and D125 rated 2-100A. Reference number suffixed Q, i.e. 10D27Q. Voltage rating 500V. Gauge rings and keys can also be supplied.

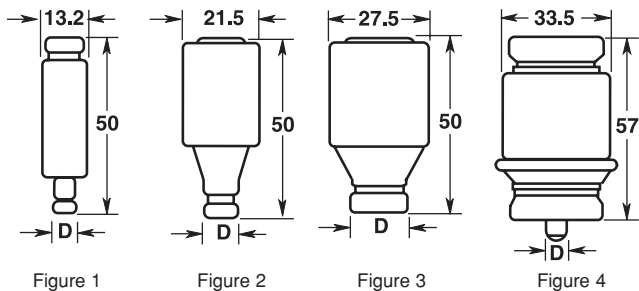

Data Sheet: 4124



Neozed Fuse

Also suitable for use on 250Vdc systems

Ampere Ratings: 2 to 63A

Voltage Rating: 400Vac

Interrupting Rating: 100kA

Catalog Number	Dimension D (mm)	Ampere Rating	Color Code
2NZ01	11	2	Pink
4NZ01	11	4	Brown
6NZ01	11	6	Green
10NZ01	11	10	Red
16NZ01	11	16	Grey
20NZ02	15	20	Blue
25NZ02	15	25	Yellow
35NZ02	15	35	Black
50NZ02	15	50	White
63NZ02	15	63	Copper

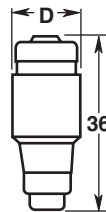

CE CE logo denotes compliance with European Union Low Voltage Directive (50-1000Vac, 75-1500Vdc). Refer to Data Sheet: 8002 or contact Bussmann Application Engineering at 636-527-1270 for more information.

Data Sheet: 4124



HRC Fuseholders



CAMASTER

HRC Fuseholders

Ampere Ratings: 30, 60 and 100A

Agency Information: CSA C22.2 No. 39; IEC 269 AND BS88

- Unique Cam-Action for ease of removal from the Fuse Bases allowing significantly improved contact pressure between Fuse Carrier and Fuse Base contacts, with a corresponding enhanced electrical performance level.
- A range of Lockable Safety Carriers for the CAMASTER Fuseholder (Cat ref: LSC), are available.

CAMASTER Ratings

Rating	Details	Catalog Number	Fuse Accommodated
30A	For HRCI-CA Applications	CM20CF	—C1F21
30A	For	CM30CF	—H07C
60A	HRCII	CM60CF	—K07C
100A	Applications	CM100CF	—K07CR

CAMASTER

Accessories for Units

Rating	Details	Catalog Number	Fuseholder Accommodated
30A	Back Stud	20BS	For CM20CF
30A		32BS	For CM30CF
60/100A		60/100BS	For CM60/100CF
All	Ganging Link Kit	GLP	For 3 Pole
All	660V Neon Indicator	NI	—
30A	Security	20LSC	For CM20CF
30A	Carrier	30LSC	For CM30CF

CE logo denotes compliance with European Union Low Voltage Directive (50-1000Vac, 75-1500Vdc). Refer to Data Sheet: 8002 or contact Bussmann Application Engineering at 636-527-1270 for more information.



SAFELOC

HRC Fuseholders

For use with HRCI-CB fuses. Suitable for bolted panel mounting or DIN rail mounting.

Ampere Ratings: 30 and 60A

SAFELOC Ratings

For use with HRCI-CB Fuses

Rating	Connection	Catalog Number	Fuse Accommodated
30A	Front	C30F	CIF06
	Back	C30BS	
	Front-Back	C30FBS	
60A	Front	C60F	EK-Amp
	Back	C60BS	
	Front-Back	C60FBS	

Features

- Designed to accommodate the compact range of offset blade fuse to CSA C22.2 No. 106, HRCI-CB.
- Carrier provides a positive, stress free fitting of fuse and locks the fuse in position ensuring safe insertion and withdrawal from the base.
- Base Contacts are fully shrouded to help protect against electric shock.
- Shrouds utilize simple slide/snap action allowing access to the contact terminal screws.
- 35mm DIN-rail mounting.
- Single screw mounting.

CE logo denotes compliance with European Union Low Voltage Directive (50-1000Vac, 75-1500Vdc). Refer to Data Sheet: 8002 or contact Bussmann Application Engineering at 636-527-1270 for more information.



NH Low Voltage Fuse Links



NH_G

Voltage Rating: 500Vac

gL/gG Category

Agency Information:

IEC269, VDE, DIN43620 Part 1

A range of industrial fuse links for a wide variety of applications.

The ordering code is made up as follows:

Rating	Product Code	Body	Category
50	NH	00	G

Type	Rating (A)	Fuse Body Size
NHC00G	6, 10, 16, 20, 25, 32, 35, 40, 50, 63, 80, 100	C00
NH00G	125, 160	00
NH1G	6, 10, 16, 20, 25, 25, 32, 35, 40, 50, 63, 80, 100, 125, 160, 200, 224, 225, 250	01
NH2G	35, 40, 50, 63, 80, 100, 125, 160, 200, 224, 250	02
NH3G	315, 350, 400, 425	2
NH3G	100, 125, 160, 200, 224, 250, 315, 350, 400	03
NH4AG	500, 630	3
NH4AG	800, 1000, 1250, 1600	4a

Dimensional Detail (mm)

Type	Rated	Depth	Width	Overall Length
NHC00G	6-100A	39.5	20.5	78.5
NH00G	125 & 160A	38	29	78.5
NH1G	6-160A	45	29	135
NH1G	200-250A	50	44.5	135
NH2G	35-250A	50	44.5	150
NH2G	315-425A	58	50	150
NH3G	100-400A	58	50	150
NH3G	500-630A	73	71	150
NH4AG	800-1000A	102	87	200
NH4AG	1250-1600A	110	95	200

CE logo denotes compliance with European Union Low Voltage Directive (50-1000Vac, 75-1500Vdc). Refer to Data Sheet: 8002 or contact Bussmann Application Engineering at 636-527-1270 for more information.



NH_M

Voltage Rating: 500Vac

aM Category

Agency Information:

IEC269, VDE, DIN43620 Part 1

A range of industrial fuse links for the protection of motor circuits.

The ordering code is made up as follows:

Rating	Product Code	Body	Category
100	NH	1	M

Type	Rating (A)	Fuse Body Size
NHC00M	4, 6, 8, 10, 12, 16, 20, 25, 32, 40, 50	C00
NH00M	63, 80, 100	00
NH1M	40, 50, 63, 80, 100, 125, 160, 200, 250	01
NH2M	125, 160, 200, 250	02
NH3M	315, 400	2
NH3M	315, 400	03
NH3M	500, 630	3

Dimensional Detail (mm)

Type	Rated	Depth	Width	Overall Length
NHC00M	4-50A	39.5	20.5	78.5
NH00M	63-100A	38	29	78.5
NH1M	40-160A	45	29	135
NH1M	200-250A	50	44.5	135
NH2M	125-250A	50	44.5	150
NH2M	315-400A	58	50	150
NH3M	315-400A	58	50	150
NH3M	500-630A	73	71	150

Data Sheet: 4173

CE logo denotes compliance with European Union Low Voltage Directive (50-1000Vac, 75-1500Vdc). Refer to Data Sheet: 8002 or contact Bussmann Application Engineering at 636-527-1270 for more information.



NH_G-690

Voltage Rating: 690Vac/250Vdc

gL/gG Category

Agency Information:

IEC269, DIN43620 Part 1

A range of industrial fuse links for a wide variety of applications where 690V is needed.

The ordering code is made up as follows:

Rating	Product Code	Body	Category
250	NH	2	G-690

Type	Rating (A)	Fuse Body Size
NH00G-690	10, 16, 20, 25, 32, 40, 50, 63, 80, 100	C00
NH1G-690	32, 40, 50, 63, 80, 100	01
NH1G-690	125, 160, 200, 200, 224, 225, 250	1
NH2G-690	100, 125, 160, 200, 224, 250, 315, 350, 400	2
NH3G-690	315, 350, 400, 500, 630	3

Dimensional Detail (mm)

Type	Rated	Depth	Width	Overall Length
NH00G-690	10-100A	38	29	78.5
NH1G-690	32-100A	45	29	135
NH1G-690	125-250A	50	44.5	135
NH2G-690	100-400A	50	44.5	150
NH3G-690	315-630A	58	50	150

Data Sheet: 4173

CE logo denotes compliance with European Union Low Voltage Directive (50-1000Vac, 75-1500Vdc). Refer to Data Sheet: 8002 or contact Bussmann Application Engineering at 636-527-1270 for more information.

For additional information on the IEC Cylindrical Fuse System, visit www.bussmann.co.uk/products.htm



NH Fuse System



SB, TB

NH-LV Fuse Bases

Voltage Rating: 660Vac

Agency Information:

DIN43620/1, VDE

A range of single and triple pole fuse bases with dimensions to DIN43620/1. The ordering code is made up as follows:

Rating: 400

Product Code: SB2

Type	Rating (A)	Fuse Body Size*
SB00	160	00
SB1	250	1
SB2	400	2
SB3	630	3
SB4	1250	4 A
TB00	160	0
TB1	250	01
TB2	400	2

SB - Single Pole Base

TB - Triple Pole Base

*Size 00 is available with "V" shaped terminal lugs, when ordering add "V" to part number i.e. SB00V/TB00V

N.B. Size 1 bases will accommodate size 0 fuse links.

Photo shown with side walls. To order side wall, reference "PB" followed by the fuse body size (i.e. PB00).

Vertical Fuse bases in size 00 to size 3 are available, details upon request.

Universal Handle: Type 630 for sizes 00 to 3. 1250A size 4A Switchable base available.

CE logo denotes compliance with European Union Low Voltage Directive (50-1000Vac, 75-1500Vdc). Refer to Data Sheet: 8002 or contact Bussmann Application Engineering at 636-527-1270 for more information.



VLB

NH-LV Vertical Load Break Fuse Switch Disconnectors

Agency Information:

IEC, DIN43620/1

A range of LV Vertical Load Break Fuse Switch Disconnectors to take NH Fuse Links in sizes 00, 1, 2 and 3.

The ordering codes are shown in the table below.

Type	Rating (A)	Fuse Body Size
VLB00	160	00
VLB1	250	1
VLB2	400	2
VLB3	630	3

Insulated and touch protected.

High Switching capacity.

Cable terminal top or bottom entry.

CE logo denotes compliance with European Union Low Voltage Directive (50-1000Vac, 75-1500Vdc). Refer to Data Sheet: 8002 or contact Bussmann Application Engineering at 636-527-1270 for more information.



LBS

NH Fuse Switch Disconnectors

Agency Information:

IEC, VDE, DIN

A range of Switch Fuses to take NH fuse link sizes 00, 1, 2 and 3.

The ordering codes are shown in the table below.

Type	Rating (A)	Fuse Body Size
LBS00	160	00
LBS1	250	1
LBS2	400	2
LBS3	630	3

HRC LV Fuse Switch Disconnectors are available for back panel mounting, size 00 can be adapted for DIN rail mounting. A range of accessories are also available.

CE logo denotes compliance with European Union Low Voltage Directive (50-1000Vac, 75-1500Vdc). Refer to Data Sheet: 8002 or contact Bussmann Application Engineering at 636-527-1270 for more information.

Data Sheet: 4169



Accessories



Spare Fuseholders

- Durable construction using black thermoplastic with UL94-VO flammability rating.
- Common mounting using #6 screws or bolts on 5-inch centers.
- Dovetailed interlocking between fuseholders simplifies installation and reduces needed hardware.
- Common footprint allows for any combination of fuseholders to be mounted together.
- Built-in retaining clips secure fuses.

Catalog Numbers	Capacity	For Use With
TPSFH-T	10-position	GMT fuses
TPSFH-AS	6-position	TPA & TPS fuses
TPSFH-N30	4-position	Class R (1-30A) fuses
TPSFH-N60	1-position	Class R (35-60A) fuses
TPSFH-LB	1-position	Class L (70-250A) series fuses
TPSFH-LC	1-position	Class L (300-600A) series fuses
TPSFH-70	12-position	Series 70 fuses (not shown)



5TPH

Midget Fuse Spare Fuse Holder

Size: 2.98" wide x 1.03" high x .63" deep

- 5-position spare fuse holder for midget size and class CC fuses ($1\frac{3}{32}$ " diameter).
- Constructed of grey thermoplastic.
- Adhesive tape on back for easy mounting on cabinet doors.

Data Sheet: 1119

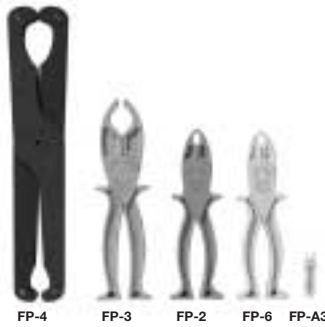

Fusepullers

Cat. No.	Application	Carton Qty.	Weight	
			Lbs.	Kg.
FP-2	$1\frac{3}{32}$ " to $1\frac{1}{16}$ " dia. fuses	1	.125	.057
FP-3	1" to $1\frac{1}{4}$ " dia. fuses	1	.173	.078
FP-4	$1\frac{1}{4}$ " to $2\frac{1}{2}$ " dia. fuses	1	.53	.24
FP-6	0-60A T-Tron fuses	1	.123	.056
FP-A3	Glass Tube & ATC fuses	10	0.08	.04

Fuse pullers are only to be used when the associated circuit has been de-energized.



FT-2

Fuse Tester 24V Maximum

- Test automotive, glass tube and ferule fuses up to $1\frac{7}{8}$ " length.
- Batteries are included.

WARNING: DO NOT test electrical fuses in the fuse panel.



SFC-FUSE-CAB

Spare Fuse Cabinet

Size: 24" wide x 30" high x 12" deep

- Five cubic feet of storage space.
- Sturdy storage cabinet conveniently holds spare fuses.
- Constructed of heavy gauge steel.
- Cabinet door equipped with locking handle.
- Durable baked ASA 61 grey enamel.
- Mounting holes with key slot 16 inches on center.

SFC SHELF

- Extra shelf for fuse cabinet.



Accessories



Fuse Reducers for Class J Dimension Fuses-LPJ, JKS

Fuse (Case) Size	Equipment Clip Size	Catalog No. (Pair) Reducer No.	*Carton Weight (Lbs.)
30A	60A	J-63	0.38
30A	100A	J-13	1.73
60A	100A	J-16	1.85
60A	†200A	J-26	2.55
100A	†200A	J-21	1.36
100A	†400A	J-41	4.90
200A	†400A	J-42	2.75
200A	†600A	J-62	1.80
400A	†600A	J-64	3.55

*Carton quantity—10 pair.
†Not for Bolt-on Applications.

Fuse Reducers for Class R Dimension Fuses FRN-R, LPN-RK—FRS-R, LPS-RK

Fuse (Case) Size	Equipment Clip Size	Catalog No. (Pairs)	
		250V	600V
30A	60A	No. 263-R	No. 663-R
30A 60A	100A	No. 213-R No. 216-R	No. 216-R No. 616-R
60A 100A	200A	No. 226-R No. 2621-R	No. 626-R No. 2621-R
100A 200A	400A	No. 2641-R No. 242-R	No. 2641-R No. 642-R
100A 200A 400A	600A	No. 2661-R No. 2662-R No. 2664-R**	No. 2661-R No. 2662-R No. 2664-R**

**Single reducer only (pair not required).

Fuse Reducers for Class H & K Dimension Fuses NON, REN—NOS, RES

Fuse (Case) Size	Equipment Clip Size	Catalog No. (Pairs)			
		250V Reducer No.	*Carton Weight (Lbs.)	600V Reducer No.	*Carton Weight (Lbs.)
30A	60A	No. 263	0.38	No. 663	1.00
30A	100A	No. 213	1.73	No. 216	1.73
60A	100A	No. 216	1.73	No. 616	1.85
60A	200A	No. 226	3.00	No. 626	3.33
100A	200A	No. 2621	1.63	No. 2621	1.63
100A	400A	No. 2641	4.90	No. 2641	4.90
200A	400A	No. 2642	3.50	No. 2642	3.50
100A	600A	No. 2661	8.70	No. 2661	8.70
200A	600A	No. 2662	6.85	No. 2662	6.85
400A	600A	No. 2664	4.45	No. 2664	4.45

*Carton quantity—10 pair.



Dummy Fuse “Neutrals” (These are not fuses)

Catalog Numbers	Fuse Equivalent			Carton Quantity
	Voltage	Dimension	Amperes	
NNB	—	1 ³ / ₃₂ " × 1 ¹ / ₂ "	—	10
NNB-R	—	Class CC	—	10
NNC	—	1/4" × 1 ¹ / ₄ "	—	10
NTN-R-30	250V	R/H	30A	10
NTN-R-60			60A	10
NTN-R-100			100A	5
NTN-R-200			200A	1
NTN-R-400			400A	1
NTS-R-30	600V	R/H	30A	10
NTS-R-60			60A	10
NTS-R-100			100A	1
NTS-R-200			200A	1
NTS-R-400			400A	1
NTS-R-600	600A	1		



Data Sheet: 1118

For complete specification data, call Bussmann Information Fax ~ 636.527.1450

Accessories



TRON Clip-Clamps

Clamp Size		Cat. No.	Ctn. Qty.	Weight	
Volts	Amps			Lbs.	Kg
250	0-30A	No. 1	12	0.66	.30
	35-60A	No. 2	12	0.96	.44
600	0-30A	No. 2	12	0.96	.44
	35-60A	No. 4	12	1.44	.65
250 or 600	70-100A	No. 5	12	1.20	.54
	110-200A	No. 6	6	1.26	.57
	225-400A	No. 7	6	1.86	.84
	450-600A	No. 8	6	2.52	1.14



Adapters for DIN and American Rails

- Buss DIN-Rail Adapters permit secure, positive snap-on mounting of Buss 0 to 30 ampere fuseblocks (one, two, or three pole) on the various size rails. (Rail mounting eliminates costly and time consuming drilling, tapping, and screw mounting.)
- Molded from "Lexan™ 141"...a very high strength but flexible material.
- Adapter mechanically locks into mounting hole of fuseblock in seconds to become an integral part of the block.
- One adapter is required for Buss one and two pole blocks. Two adapters are required for three pole blocks.
- With the exception of the 32mm DIN-rail, all blocks with adapters can be removed from a rail simply by pulling up its release tab.
- Use of rail end-stops on both sides of adapters is recommended.

Adapter Catalog Data (For 0-30 Ampere Fuseblocks)

Fuseblock Class	Rails		Adapter	
	Type	Size	Color	Cat. No.
CC G *H (250V) *R (250) M Type	DIN	15mm (Symm.) 32mm (Asymm.) 35mm (Symm.)	Black	DRA-1
American		17/64" (Symm.) (also 35mm DIN)		

Package Quantities: standard—10; bulk—100 (Cat. No. BK/DRA-1 or BK/DRA-2.)

*Mounting on 15mm rails is not recommended.

NOTE—New model Buss fuseblocks have elongated block-to-adapter mounting holes (old style fuseblocks will not accept the rail adapters).



Fuse Display Racks



Fusetron® View-Pack Fuse Display Rack

Catalog Symbol: FR-1000

The FR-1000 is a complete assortment of Fusetron View-Packs with a display rack. When you order a "FR-1000", you receive five each of the View-Packs listed below, plus a heavy-duty wire rack. The rack is designed to hang from a pegboard or stand on a shelf. The FR-1000 measures 32" wide, 18" tall and 10" deep.

Fusetron View-Packs

Catalog Number
FRN-R-15-VP
FRN-R-20-VP
FRN-R-25-VP
FRN-R-30-VP
FRN-R-35-VP
FRN-R-40-VP
FRN-R-45-VP
FRN-R-50-VP
FRN-R-60-VP
FRS-R-15-VP
FRS-R-20-VP
FRS-R-25-VP
FRS-R-30-VP
FRS-R-35-VP
FRS-R-40-VP
FRS-R-45-VP
FRS-R-50-VP
FRS-R-60-VP



Plug Fuse Display

Catalog Symbol: PFD-948

Sturdy plastic display features complete assortment of plug fuses. Each display comes with a set of labels that permits customizing the product mix.

Display measures 29" wide x 15" tall x 5" deep.

PFD-948 Display

Contents	Boxes*	Fuses
W-15	25	100
W-20	25	100
W-25	12	48
W-30	25	100
TL-15	25	100
TL-20	25	100
TL-30	25	100
SL-15	25	100
SL-20	25	100
SL-30	25	100

*Each box contains 4 fuses.

Displays without fuses are also available. Order **EMPTY-PFD** to receive the display only.

The PFD-948 is packed one per carton. Carton size is 18½" x 13½" x 31¼", weight is 75 lbs. The EMPTY-PFD is also packed one per carton. Carton size is 16" x 6" x 31¼", weight is 6 lbs.

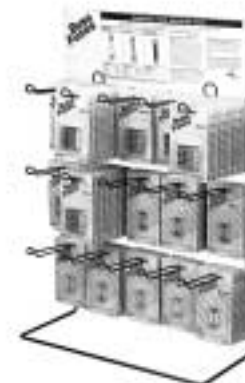

Electronic Fuse Display

Catalog Symbol: No.15

A complete assortment of 125 volt and 250 volt fuses for electronic equipment. The No. 15 display contains fifteen of the most popular fuses for electronic equipment, such as microwaves, computers, stereos, CB radios, or office equipment. The sturdy wire rack holds twelve cards of each fuse, and can be hung from a pegboard or stood on a shelf.

- **Header card** explains fuse types and offers safety precautions.
- **Sturdy wire rack** can be hung from a pegboard or stood on a shelf. There is no charge for the rack, when purchased with the display.

No. 15 Display and Refills

Contents	Fuses/ Card	Cards/ Display
BP/AGC-½	5	5
BP/AGC-1	5	10
BP/AGC-1½	5	5
BP/AGC-2	5	5
BP/AGC-3	5	10
BP/AGC-4	5	5
BP/AGC-5	5	10
BP/MDL-½	2	5
BP/MDL-1	2	5
BP/MDL-1½	2	5
BP/MDL-2	2	5
BP/MDL-3	2	5
BP/MDL-5	2	5
BP/ABC-10	2	5
BP/ABC-15	2	5
No. 15 (Display)	—	90

Display rack measures: 18¼" x 10½" x 24"



Service Kits



Low-Peak® Fuse Service Kit

Catalog Symbol: LPRK-28

- Convenient, compact kit to hold spare fuses.
- Sturdy nylon box with handle rugged enough to withstand field use.
- Extra spaces and changeable compartments make it easy to customize for your particular need.

Contents

(2) LPN-RK-3 ³ / ₁₀ SP	(2) LPN-RK-40 SP
(2) LPN-RK-6 ¹ / ₄ SP	(2) LPN-RK-50 SP
(2) LPN-RK-10 SP	(3) LPN-RK-60 SP
(2) LPN-RK-15 SP	(2) LPN-RK-100 SP
(3) LPN-RK-20 SP	(2) No. 263-R Reducers
(2) LPN-RK-25 SP	(2) No. 1 Clip Clamps
(4) LPN-RK-30 SP	(2) No. 2 Clip Clamps
(2) LPN-RK-35 SP	(1) FP-2 Fusepuller



Fusetron® Fuse Service Kit

Catalog Symbol: ERK-28

- Convenient, compact kit to hold spare fuses.
- Sturdy nylon box with handle rugged enough to withstand field use.
- Extra spaces and changeable compartments make it easy to customize for your particular need.

Contents

(2) FRN-R-3 ³ / ₁₀	(2) FRN-R-40
(2) FRN-R-6 ¹ / ₄	(2) FRN-R-50
(2) FRN-R-10	(3) FRN-R-60
(2) FRN-R-15	(2) FRN-R-100
(3) FRN-R-20	(2) No. 263-R Reducers
(2) FRN-R-25	(2) No. 1 Clip Clamps
(4) FRN-R-30	(2) No. 2 Clip Clamps
(2) FRN-R-35	



Midget Fuse Emergency Kit

Quick Service Replacement for 1³/₃₂" x 1¹/₂" fuses

Catalog Symbol: No. 36

- A sturdy nylon box is ideal for factory or service truck use.
- Cross reference makes it easy to install correct fuse in any application.
- Free fuse puller enclosed in box.

Contents

(2) FNQ-R- ¹ / ₂	(2) KTK-R-1
(2) FNQ-R-1	(2) KTK-R-2
(2) FNQ-R-2	(2) KTK-R-3
(2) FNQ-R-3	(2) KTK-R-5
(2) FNQ-R-4	(2) KTK-R-6
(2) FNQ-R-5	(2) KTK-R-10
(2) FNQ-10	(2) KTK-R-15
(2) FNQ-15	(2) KTK-R-20
(2) FNQ-20	(2) KTK-R-30
(1) FP-2	

Kit size: 10⁷/₈" x 6⁵/₈" x 1³/₄".



Service Kits



Small Dimension Fuse Assortment Kit

Catalog Symbol: No. 270

Voltage Rating: 125V and 250V

Contains 270 assorted fuses plus fuseholders, fuseblocks and fuse clips to fit most electronic equipment.

Electronic Fuse Assortment

(5) MDL- $\frac{1}{8}$	(5) ABC-10
(5) MDL- $\frac{1}{4}$	(5) ABC-15
(5) MDL- $\frac{1}{2}$	(5) ABC-20
(5) MDL- $\frac{3}{4}$	(5) ABC-30
(5) MDL-1	(5) GMA-250mA
(5) MDL-1 $\frac{1}{2}$	(5) GMA-500mA
(5) MDL-2	(5) GMA-1A
(5) MDL-3	(5) GMA-2A
(5) MDL-4	(5) GMA-3A
(5) MDL-5	(5) GMA-4A
(5) MDL-6	(5) GMA-6A
(5) MDA-8	(5) GMC-1A
(5) MDA-10	(5) GMC-2A
(5) MDA-15	(5) GMC-3A
(5) MDA-20	(5) GMC-4A
(5) MDA-30	(5) GMC-6A
(5) AGC- $\frac{1}{8}$	(5) AGC-V- $\frac{1}{2}$
(5) AGC- $\frac{1}{4}$	(5) AGC-V-1
(5) AGC- $\frac{1}{2}$	(5) AGC-V-2
(5) AGC- $\frac{3}{4}$	(5) AGC-V-3
(5) AGC-1	(5) MDL-V- $\frac{1}{2}$
(5) AGC-1 $\frac{1}{2}$	(5) MDL-V-1
(5) AGC-2	(5) MDL-V-2
(5) AGC-2 $\frac{1}{2}$	(5) MDL-V-3
(5) AGC-3	(1) S-8202-2
(5) AGC-4	(1) HTB-26I
(5) AGC-5	(1) HTB-28M
(5) AGC-6	(2) Pr. 4121 Fuseclips
(5) AGC-7	(2) HHB
(5) AGC-8	



Small Dimension Fuse Assortment Kit

Catalog Symbol: No. 140

Voltage Rating: 125V & 250V

Contains 140 assorted fuses plus fuseholders, fuseblocks and fuse clips to fit most electronic equipment.

Electronic Fuse Assortment

(5) MDL- $\frac{1}{2}$	(5) AGC-1 $\frac{1}{2}$
(5) MDL-1	(5) AGC-2
(5) MDL-1 $\frac{1}{2}$	(5) AGC-3
(5) MDQ-2	(5) MTH-4
(5) MDQ-3	(5) MTH-5
(5) MDQ-4	(5) MTH-6
(5) MDQ-5	(5) MTH-7
(5) MDQ-6	(5) MTH-8
(5) MDA-8	(5) ABC-10
(5) MDA-10	(5) ABC-15
(5) MDA-15	(5) ABC-20
(5) MDA-20	(5) ABC-30
(5) MDA-30	(2) Pr. #4121 Fuseclips
(5) AGC- $\frac{1}{4}$	(2) HHB
(5) AGC- $\frac{1}{2}$	(1) FP-A3
(5) AGC-1	



5mm x 20mm Fuse Assortment Kit

Catalog Symbol: No. 220

Voltage Rating: 125V & 250V

A complete assortment of 125V and 250V 5mm x 20mm size fuses for the repair of both electrical and electronic devices.

Contents

Product Type	Ampere Ratings Contains 5 each
GMA	250ma, 500ma, 1, 1.5, 2, 2.5, 3, 4, 5, 10
GDA	630ma, 1, 2, 3.15, 5, 6.3
GDB	630ma, 2, 3.15, 4
GMC	500ma, 750ma, 1, 2, 2.5, 3, 3.15, 4, 5, 6.3
GMD	200ma, 500ma, 1, 1.6, 2, 3
GDC	250ma, 500ma, 1, 1.6, 2, 3.15, 4, 5
HTB-28m, FP-A3	



Fuse Display Racks



Electronic Fuse Display

Catalog Symbol: No. 205
Compact display of 125V and 250V fuses.

Size: 6³/₄" W x 16" H x 4" D

Fuse	Quantity	Fuse	Quantity
AGC-1/2	5	MDL-1	10
AGC-1	10	MDL-1 1/2	5
AGC-1 1/2	5	MDL-2	10
AGC-2	10	MDL-3	10
AGC-3	10	MDL-4	5
AGC-4	5	MDL-5	5
AGC-5	10	MDL-6	5
AGC-6	5	MDL-7	5
AGC-7	5	MDL-8	5
AGC-8	5	GLH-7	15
AGC-10	5	GMA-500mA	5
ABC-10	5	GMA-1A	5
ABC-15	15	GMA-2A	5
ABC-20	5	GMA-3A	5
MDL 1/2	5	GMA-5A	5



No. 200 & No. 201 Glass Tube and Blade-Type Automotive Fuses

The "200"—40 boxes (172 fuses).

Size: 4" x 6³/₄" x 10" (270 cu. in.)

Fuse	Quantity	Fuse	Quantity
AGC-1	5	ATM-2	5
AGC-2	5	ATM-3	5
AGC-3	5	ATM-4	5
AGC-5	5	ATM-5	5
AGC-7 1/2	5	ATM-7 1/2	5
AGC-10	5	ATM-10	5
AGC-15	5	ATM-15	5
AGC-20	5	ATM-20	5
AGC-25	5	ATM-25	5
AGC-30	5	ATM-30	5
ATC-3	5	GBC-8	5
ATC-4	5	MAX-20	5
ATC-5	5	MAX-30	5
ATC-7 1/2	5	MAX-40	2
ATC-10	5	MAX-50	1
ATC-15	5	MAX-60	2
ATC-20	10	SFE-14	5
ATC-25	5	SFE-20	5
ATC-30	5		

The "201"—40 boxes (172 fuses).
Comes in handy, clear plastic service kit.
Fuse assortment same as the "200".
3" x 4" x 10" (142.5 cu. in.)



No. 2880 Empty Counter or Wall Stock Display Rack

- Holds 2880 fuses (574 boxes of 5 each).
- Six removable sections with four channels. Units may be interlocked without screws.



Christmas Light Fuses and Displays

Bussmann offers a comprehensive line of replacement fuses for all Christmas tree lights and decorative light products.

Display Cartons

Part No.	Description	Carton Quantity
BP/AGX-7X5	5 AGX-7A, 125V Fuses 1/4" x 1" Glass Tube	20 Cards
BP/GLH-7X5	5 GLH-7A, 125V Fuses 1/4" x 1 1/4" Glass Tube	20 Cards
BP/MAS-3X5	5 MAS-3A, 125V Fuses 3.6mm x 10mm Glass Tube	20 Cards
BP/XMAS-6F	Assortment: 6 Fuses (2 ea. AGX-7, GLH-7, MAS-3)	20 Cards

Clip Strip

Part No.	Description	Quantity
CS/XMAS-6F	Assortment: 6 Fuses (2 ea. AGX-7, GLH-7, MAS-3)	20 Cards

Note: Order by the card (each in multiples of 20).

Package Specifications

Part No.	Card Size			Display Carton		
	H	W	D	H	W	Weight
BP/AGX-7X5	4 3/4"	2 3/4"	7 1/4"	6 1/4"	5 3/4"	1 lb. 10 oz.
BP/GLH-7X5	4 3/4"	2 3/4"	7 1/4"	6 1/4"	5 3/4"	1 lb. 10 oz.
BP/MAS-3X5	4 3/4"	2 3/4"	7 1/4"	6 1/4"	5 3/4"	1 lb. 10 oz.
BP/XMAS-6F	4 3/4"	2 3/4"	7 1/4"	6 1/4"	5 3/4"	1 lb. 10 oz.
CS/XMAS-6F	4 3/4"	2 3/4"	6 1/2"	2 7/8"	6 1/4"	1 lb. 4 oz.



Fuse Display Racks



FDM-1

Fuse Display Merchandiser

- Bussmann tilt-bin display maximizes your space and stimulates impulse purchases.
- Interlocking bins can be stacked or mounted on peg board.
- Header card easily attaches with plastic push pegs.
- Provides a flexible system to best fit your needs and space requirements.
- The tilt bins are available in five and six bin models.

Fuse Display Merchandiser will consist of any number of either size bins; header card push pegs to attach and part number labels.

Part Number	Description
1A9721	5 Bin Display 23 $\frac{3}{8}$ " long x 6 $\frac{1}{2}$ " tall x 5 $\frac{1}{2}$ " deep
1A9722	6 Bin Display 23 $\frac{3}{8}$ " long x 4 $\frac{1}{2}$ " tall x 3 $\frac{5}{8}$ " deep



FSD

Key Features & Benefits:

- Prominent "Silent Salesman".
- Sturdy Steel Construction.
- Selection of fastest selling sizes and amps.
- Flip chart for applications, cross referencing and fuse types.
- Clear tilt bins allow for quick identification, easy access, inventory restocking.
- Heavy duty casters allow for easy repositioning.
- Modular system provides flexibility for growth by joining two or more units together. (Back-to-back or side-by-side).
- Product part number adhesive labels.
- Standard Gondola Measures:
24" wide x 66" tall x 21 $\frac{1}{2}$ " deep

Part Number	Carton Quantity	Part Number	Carton Quantity	Part Number	Carton Quantity
FNQ-R-1/4	10	FNM-15	10	NON-35	10
FNQ-R-1/2	10	LP-CC-5	10	NON-40	10
FNQ-R-1	10	LP-CC-10	10	NON-45	10
FNQ-R-1-1/2	10	LP-CC-15	10	NON-50	10
FNQ-R-2	10	LP-CC-20	10	NON-60	10
FNQ-R-3	10	LP-CC-30	10	T-15	4
FNQ-R-4	10	FRN-R-5	10	T-20	4
FNQ-R-5	10	FRN-R-10	10	T-30	4
FNQ-R-10	10	FRN-R-15	10	W-15	4
FNQ-15	10	FRN-R-20	10	W-20	4
FNQ-20	10	FRN-R-25	10	FRS-R-5	10
FNQ-25	10	FRN-R-30	10	FRS-R-10	10
FNQ-30	10	FRN-R-35	10	FRS-R-15	10
FP2	10	FRN-R-40	10	FRS-R-20	10
FP3	10	FRN-R-45	10	FRS-R-25	10
KTK-R-5	10	FRN-R-50	10	FRS-R-30	10
KTK-R-10	10	FRN-R-60	10	FRS-R-35	10
KTK-R-15	10	NON-3	10	FRS-R-40	10
KTK-R-20	10	NON-6	10	FRS-R-50	10
KTK-R-30	10	NON-10	10	FRS-R-60	10
FNM-2	10	NON-15	10	FRS-R-100	1
FNM-5	10	NON-20	10	FRS-R-200	1
FNM-10	10	NON-30	10		



Circuit Protection

Electrical distribution systems are often quite complicated. They cannot be absolutely fail-safe. Circuits are subject to destructive overcurrents. Harsh environments, general deterioration, accidental damage, damage from natural causes, excessive expansion, and/or overloading of the electrical distribution system are factors which contribute to the occurrence of such overcurrents. Reliable protective devices prevent or minimize costly damage to transformers, conductors, motors, and the other many components and loads that make up the complete distribution system. Reliable circuit protection is essential to avoid the severe monetary losses which can result from power blackouts and prolonged downtime of facilities. It is the need for reliable protection, safety, and freedom from fire hazards that has made the fuse a widely used protective device.

Overcurrents

An overcurrent is either an overload current or a short-circuit current. The overload current is an excessive current relative to normal operating current, but one which is confined to the normal conductive paths provided by the conductors and other components and loads of the distribution system. As the name implies, a short-circuit current is one which flows outside the normal conducting paths.

Overloads

Overloads are most often between one and six times the normal current level. Usually, they are caused by harmless temporary surge currents that occur when motors are started-up or transformers are energized. Such overload currents, or transients, are normal occurrences. Since they are of brief duration, any temperature rise is trivial and has no harmful effect on the circuit components. (It is important that protective devices do not react to them.)

Continuous overloads can result from defective motors (such as worn motor bearings), overloaded equipment, or too many loads on one circuit. Such sustained overloads are destructive and must be cut off by protective devices before they damage the distribution system or system loads. However, since they are of relatively low magnitude compared to short-circuit currents, removal of the overload current within minutes will generally prevent equipment damage. A sustained overload current results in overheating of conductors and other components and will cause deterioration of insulation, which may eventually result in severe damage and short-circuits if not interrupted.

Short-Circuits

Whereas overload currents occur at rather modest levels, the short-circuit or fault current can be many hundred times larger than the normal operating current. A high level fault may be 50,000A (or larger). If not cut off within a matter of a few thousandths of a second, damage and destruction can become

rampant—there can be severe insulation damage, melting of conductors, vaporization of metal, ionization of gases, arcing, and fires. Simultaneously, high level short-circuit currents can develop huge magnetic-field stresses. The magnetic forces between bus bars and other conductors can be many hundreds of pounds per linear foot; even heavy bracing may not be adequate to keep them from being warped or distorted beyond repair.

Fuses

The fuse is a reliable overcurrent protective device. A “fusible” link or links encapsulated in a tube and connected to contact terminals comprise the fundamental elements of the basic fuse. Electrical resistance of the link is so low that it simply acts as a conductor. However, when destructive currents occur, the link very quickly melts and opens the circuit to protect conductors and other circuit components and loads. Fuse characteristics are stable. Fuses do not require periodic maintenance or testing. Fuses have three unique performance characteristics:

- 1. Modern fuses have an extremely “high interrupting rating”—can withstand very high fault currents without rupturing.**
- 2. Properly applied, fuses prevent “blackouts.” Only the fuse nearest a fault opens without upstream fuses (feeders or mains) being affected—fuses thus provide “selective coordination.” (These terms are precisely defined in subsequent pages.)**
- 3. Fuses provide optimum component protection by keeping fault currents to a low value...They are said to be “current limiting.”**

Voltage Rating

The voltage rating of a fuse must be at least equal to or greater than the circuit voltage. It can be higher but never lower. For instance, a 600V fuse can be used in a 208V circuit.

The voltage rating of a fuse is a function of its capability to open a circuit under an overcurrent condition. Specifically, the voltage rating determines the ability of the fuse to suppress the internal arcing that occurs after a fuse link melts and an arc is produced. If a fuse is used with a voltage rating lower than the circuit voltage, arc suppression will be impaired and, under some fault current conditions, the fuse may not clear the overcurrent safely. Special consideration is necessary for semiconductor fuse and medium voltage fuse applications, where a fuse of a certain voltage rating is used on a lower voltage circuit.

Ampere Rating

Every fuse has a specific ampere rating. In selecting the ampere rating of a fuse, consideration must be given to the type of load and code requirements. The ampere rating of a fuse normally should not exceed the current carrying capacity of the circuit. For

instance, if a conductor is rated to carry 20A, a 20A fuse is the largest that should be used. However, there are some specific circumstances in which the ampere rating is permitted to be greater than the current carrying capacity of the circuit. A typical example is the motor circuit; dual-element fuses generally are permitted to be sized up to 175% and non-time-delay fuses up to 300% of the motor full-load amperes. As a rule, the ampere rating of a fuse and switch combination should be selected at 125% of the continuous load current (this usually corresponds to the circuit capacity, which is also selected at 125% of the load current). There are exceptions, such as when the fuse-switch combination is approved for continuous operation at 100% of its rating.

Interrupting Rating

A protective device must be able to withstand the destructive energy of short-circuit currents. If a fault current exceeds the capability of the protective device, the device may actually rupture, causing additional damage. Thus, it is important when applying a fuse or circuit breaker to use one which can sustain the largest potential short-circuit currents. The rating which defines the capacity of a protective device to maintain its integrity when reacting to fault currents is termed its “interrupting rating”. The interrupting rating of most branch-circuit, molded case, circuit breakers typically used in residential service entrance panels is 10,000A. (Please note that a molded case circuit breaker’s interrupting capacity will typically be lower than its interrupting rating.) Larger, more expensive circuit breakers may have interrupting ratings of 14,000A or higher. In contrast, most modern, current-limiting fuses have an interrupting rating of 200,000 or 300,000A and are commonly used to protect the lower rated circuit breakers. The National Electrical Code, Section 110-9, requires equipment intended to break current at fault levels to have an interrupting rating sufficient for the current that must be interrupted.

Selective Coordination – Prevention of Blackouts

The coordination of protective devices prevents system power outages or blackouts caused by overcurrent conditions. When only the protective device nearest a faulted circuit opens and larger upstream fuses remain closed, the protective devices are “selectively” coordinated (they discriminate). The word “selective” is used to denote total coordination...isolation of a faulted circuit by the opening of only the localized protective device.

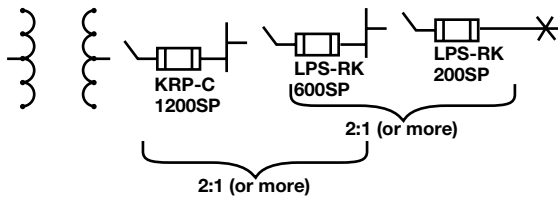

This diagram shows the minimum ratios of ampere ratings of LOW-PEAK YELLOW fuses that are required to provide “selective coordination” (discrimination) of upstream and downstream fuses.

Unlike electro-mechanical inertial devices (circuit breakers), it is a simple matter to selectively coordinate fuses of modern design. By maintaining a minimum ratio of fuse-ampere ratings between an upstream and downstream fuse, selective coordination is assured.

Current Limitation – Component Protection

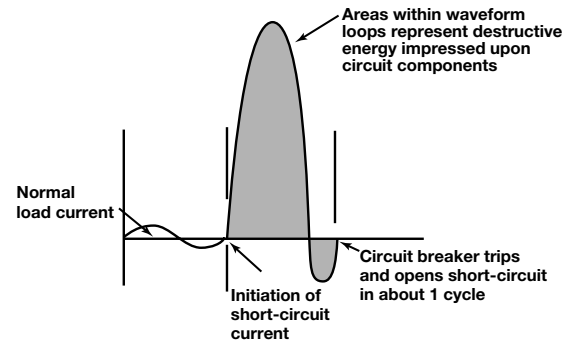

A non-current-limiting protective device, by permitting a short-circuit current to build up to its full value, can let an immense amount of destructive short-circuit heat energy through before opening the circuit.

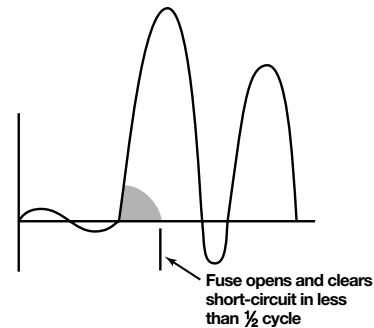

A current-limiting fuse has such a high speed of response that it cuts off a short-circuit long before it can build up to its full peak value.

If a protective device cuts off a short-circuit current in less than one-quarter cycle, before it reaches its total available (and highly destructive) value, the device is a “current-limiting” device. Most modern fuses are current-limiting. They restrict fault currents to such low values that a high degree of protection is given to circuit components against even very high short-circuit currents. They permit breakers with lower interrupting ratings to be used. They can reduce bracing of bus structures. They minimize the need of other components to have high short-circuit current “withstand” ratings. If not limited, short-circuit currents can reach levels of 30,000 or 40,000A or higher in the first half cycle (.008 seconds, 60 Hz) after the start of a short-circuit. The heat that can be produced in circuit components by the immense energy of short-circuit currents can cause severe insulation damage or even explosion. At the same time, huge magnetic forces developed between conductors can crack insulators and distort and destroy bracing structures. Thus, it is important that a protective device limit fault currents before they reach their full potential level.

Operating Principles of Bussmann® Fuses

The principles of operation of the modern, current-limiting Buss fuses are covered in the following paragraphs.

Non-Time-Delay Fuses

The basic component of a fuse is the link. Depending upon the ampere rating of the fuse, the single-element fuse may have one or more links. They are electrically connected to the end blades (or ferrules) (see Figure 1) and enclosed in a tube or cartridge surrounded by an arc quenching filler material. BUSS® LIMITRON® and T-TRON® fuses are both single-element fuses.

Under normal operation, when the fuse is operating at or near its ampere rating, it simply functions as a conductor. However, as illustrated in Figure 2, if an overload current occurs and persists for more than a short interval of time, the temperature of the link eventually reaches a level which causes a restricted segment of the link to melt. As a result, a gap is formed and an electric arc established. However, as the arc causes the link metal to burn back, the gap becomes progressively larger. Electrical resistance of the arc eventually reaches such a high level that the arc cannot be sustained and is extinguished. The fuse will have then completely cut off all current flow in the circuit. Suppression or quenching of the arc is accelerated by the filler material. (See Figure 3.)

Single-element fuses of present day design have a very high speed of response to overcurrents. They provide excellent short-circuit component protection. However, temporary, harmless overloads or surge currents may cause nuisance openings unless these fuses are oversized. They are best used, therefore, in circuits not subject to heavy transient surge currents and the temporary over-load of circuits with inductive loads such as motors, transformers, solenoids, etc. Because single-element, fast-acting fuses such as LIMITRON and T-TRON fuses have a high speed of response to short-circuit currents, they are particularly suited for the protection of circuit breakers with low interrupting ratings.

Whereas an overload current normally falls between one and six times normal current, short-circuit currents are quite high. The fuse may be subjected to short-circuit currents of 30,000 or 40,000A or higher. Response of current limiting fuses to such currents is extremely fast. The restricted sections of the fuse link will simultaneously melt (within a matter of two or three-thousandths of a second in the event of a high-level fault current).

The high total resistance of the multiple arcs, together with the quenching effects of the filler particles, results in rapid arc suppression and clearing of the circuit. (Refer to Figures 4 & 5) Short-circuit current is cut off in less than a half-cycle, long before the short-circuit current can reach its full value (fuse operating in its current limiting range).



Figure 1. Cutaway view of typical single-element fuse.



Figure 2. Under sustained overload, a section of the link melts and an arc is established.



Figure 3. The "open" single-element fuse after opening a circuit overload.



Figure 4. When subjected to a short-circuit current, several sections of the fuse link melt almost instantly.



Figure 5. The "open" single-element fuse after opening a short circuit.

Bussmann® Dual-Element Fuses

There are many advantages to using these fuses. Unlike single-element fuses, the Bussmann® dual-element, time-delay fuses can be sized closer to provide both high performance short-circuit protection and reliable overload protection in circuits subject to temporary overloads and surge currents. For ac motor loads, a single-element fuse may need to be sized at 300% of an a.c. motor current in order to hold the starting current. However, dual-element, time delay fuses can be sized much closer to motor loads. For instance, it is generally possible to size FUSETRON® Dual-Element Fuses, FRS-R and FRN-R and LOW-PEAK® Dual-Element Fuses, LPS-RK_SP and LPN-RK_SP, at 125% and 130% of motor full load current, respectively. Generally, the LOW-PEAK® Dual-Element Fuses, LPJ_SP, and CUBEFuse™, TCF, can be sized at 150% of motor full load amperes. This closer fuse sizing may provide many advantages such as: (1) smaller fuse and block, holder or disconnect ampere rating and physical size, (2) lower cost due to lower ampere rated devices and possibly smaller required panel space, (3) better short-circuit protection – less short-circuit current let-through energy, and (4) potential reduction in the arc flash hazard.



Figure 6. This is the LPS-RK100SP, a 100A, 600V LOW-PEAK®, Class RK1, Dual-Element Fuse that has excellent time-delay, excellent current-limiting and a 300,000A interrupting rating. Artistic liberty is taken to illustrate the internal portion of this fuse. The real fuse has a non-transparent tube and special small granular, arc-quenching material completely filling the internal space.

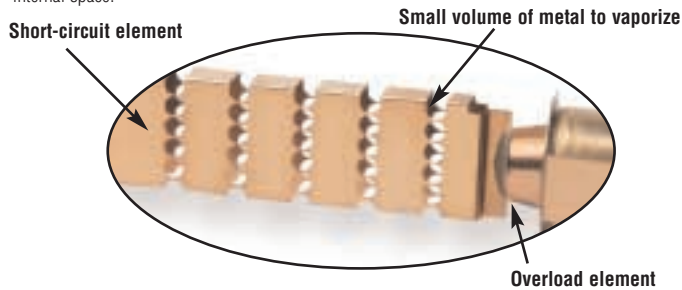

Figure 7. The true dual-element fuse has distinct and separate overload element and short-circuit element.

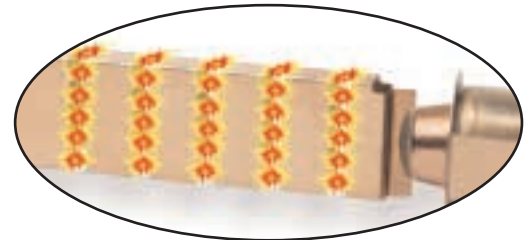

Figure 9. Short-circuit operation: Modern fuses are designed with minimum metal in the restricted portions which greatly enhance their ability to have excellent current-limiting characteristics – minimizing the short circuit let-through current. A short-circuit current causes the restricted portions of the short-circuit element to vaporize and arcing commences. The arcs burn back the element at the points of the arcing. Longer arcs result, which assist in reducing the current. Also, the special arc quenching filler material contributes to extinguishing the arcing current. Modern fuses have many restricted portions, which results in many small arclets – all working together to force the current to zero.

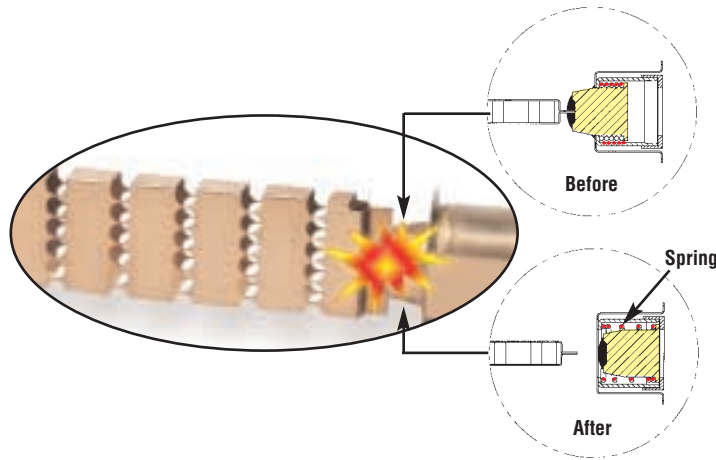

Figure 8. Overload operation: Under sustained overload conditions, the trigger spring fractures the calibrated fusing alloy and releases the “connector”. The insets represent a model of the overload element before and after. The calibrated fusing alloy connecting the short-circuit element to the overload element fractures at a specific temperature due to a persistent overload current. The coiled spring pushes the connector from the short-circuit element and the circuit is interrupted.

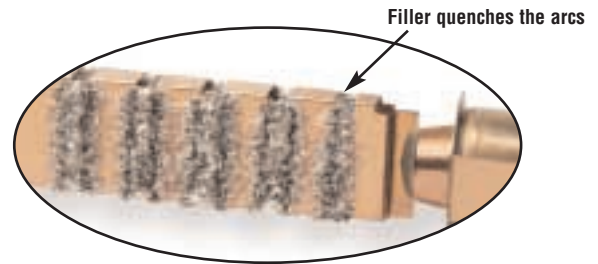

Figure 10. Short-circuit operation: The special small granular, arc-quenching material plays an important part in the interruption process. The filler assists in quenching the arcs; the filler material absorbs the thermal energy of the arcs, fuses together and creates an insulating barrier. This process helps in forcing the current to zero. Modern current-limiting fuses, under short-circuit conditions, can force the current to zero and complete the interruption within a few thousandths of a second.

When the short-circuit current is in the current-limiting range of a fuse, it is not possible for the full available short-circuit current to flow through the fuse – it’s a matter of physics. The small restricted portions of the short-circuit element quickly vaporize and the filler material assists in forcing the current to zero. The fuse is able to “limit” the short-circuit current.

Overcurrent protection must be reliable and sure. Whether it is the first day of the electrical system or thirty or more years later, it is important that overcurrent protective devices perform under overload or short-circuit conditions as intended. Modern current-limiting fuses operate by very simple, reliable principles.

Fuse Time-Current Curves

When a low level overcurrent occurs, a long interval of time will be required for a fuse to open (melt) and clear the fault. On the other hand, if the overcurrent is large, the fuse will open very quickly. The opening time is a function of the magnitude of the level of overcurrent. Overcurrent levels and the corresponding intervals of opening times are logarithmically plotted in graph form as shown to the right. Levels of overcurrent are scaled on the horizontal axis; time intervals on the vertical axis. The curve is thus called a “time-current” curve.

This particular plot reflects the characteristics of a 200A, 250V, LOW-PEAK YELLOW dual-element fuse. Note that at the 1,000A overload level, the time interval which is required for the fuse to open is 10 seconds. Yet, at approximately the 2,200A overcurrent level, the opening (melt) time of a fuse is only 0.01 seconds. It is apparent that the time intervals become shorter as the overcurrent levels become larger. This relationship is termed an inverse time-to-current characteristic. Time-current curves are published or are available on most commonly used fuses showing “minimum melt,” “average melt” and/or “total clear” characteristics. Although upstream and downstream fuses are easily coordinated by adhering to simple ampere ratios, these time-current curves permit close or critical analysis of coordination.

Better Motor Protection in Elevated Ambients

The derating of dual-element fuses based on increased ambient temperatures closely parallels the derating curve of motors in elevated ambient. This unique feature allows for optimum protection of motors, even in high temperatures.

Affect of ambient temperature on operating characteristics of FUSETRON

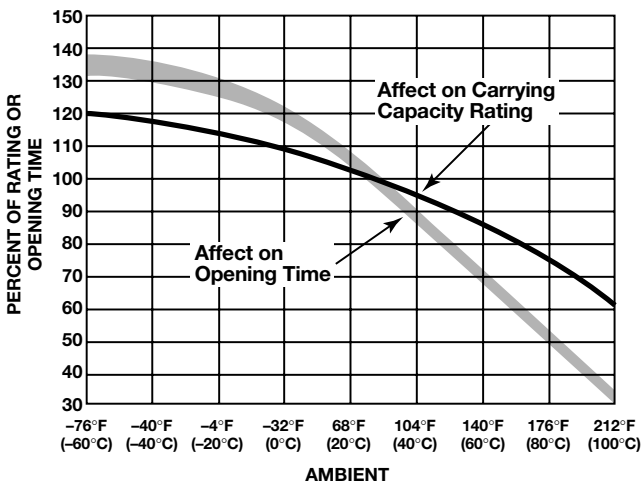

and LOW-PEAK YELLOW Dual-Element Fuses.

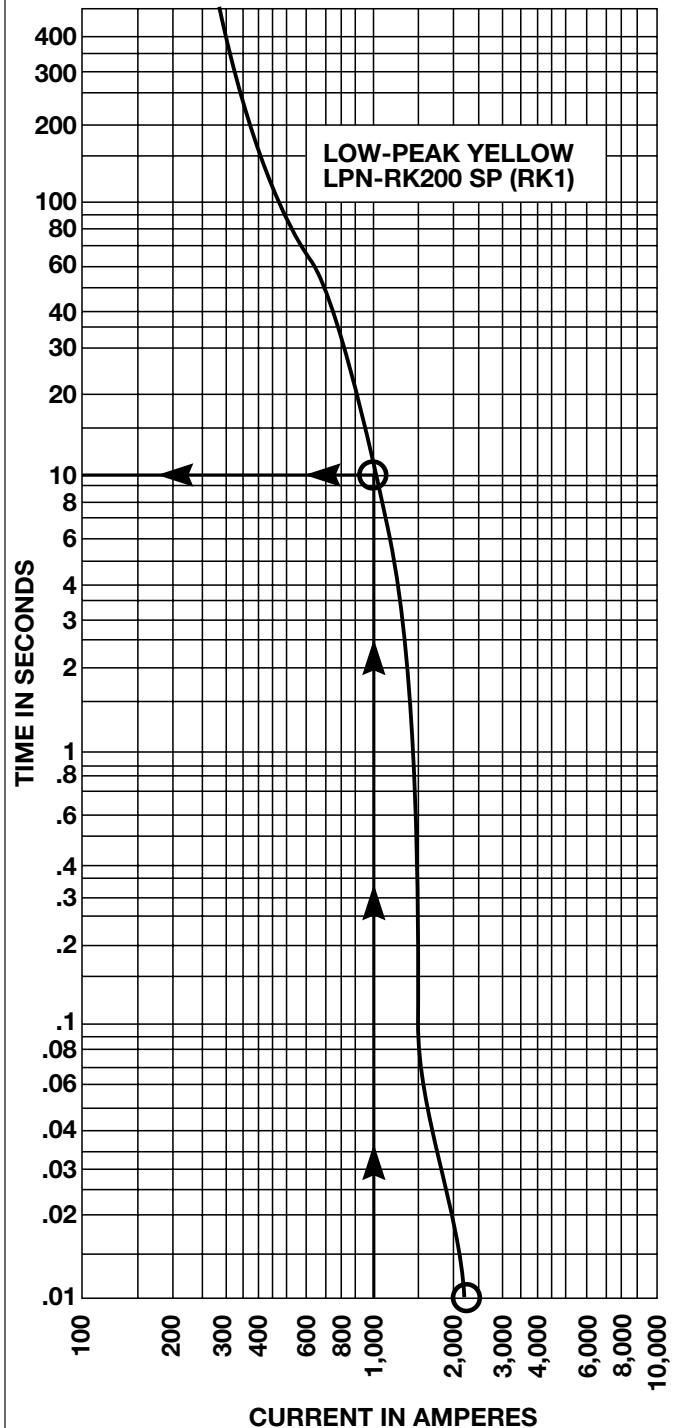

Better Protection Against Motor Single Phasing

When secondary single-phasing occurs, the current in the remaining phases increases to approximately 200% rated full load current. (Theoretically 173%, but change in efficiency and power factor make it about 200%.) When primary single-phasing occurs, unbalanced voltages occur on the motor circuit causing currents to rise to 115%, and 230% of normal running currents in delta-wye systems.

Dual-element fuses sized for motor running overload protection will help to protect motors against the possible damages of single-phasing.

Classes of Fuses

Safety is the industry mandate. However, proper selection, overall functional performance and reliability of a product are factors which are not within the basic scope of listing agency activities. In order to develop its safety test procedures, listing agencies develop basic performance and physical specifications or standards for a product. In the case of fuses, these standards have culminated in the establishment of distinct classes of low-voltage (600V or less) fuses; classes RK1, RK5, G, L, T, J, H and CC being the more important.

The fact that a particular type of fuse has, for instance, a classification of RK1, does not signify that it has the identical function or performance characteristics as other RK1 fuses. In fact, the LIMITRON® non-time-delay fuse and the LOW-PEAK YELLOW™ dual-element, time-delay fuse are both classified as RK1. Substantial differences in these two RK1 fuses usually requires considerable difference in sizing. Dimensional specifications of each class of fuse does serve as a uniform standard.

Class R Fuses

Class R ("R" for rejection) fuses are high performance, $\frac{1}{10}$ to 600A units, 250V and 600V, having a high degree of current limitation and a short-circuit interrupting rating of up to 300,000A (rms symmetrical). BUSS Class R's include Classes RK1 LOW-PEAK YELLOW™ and LIMITRON® fuses, and RK5 FUSETRON® fuses. They have replaced BUSS K1 LOW-PEAK and LIMITRON fuses and K5 FUSETRON fuses. These fuses are identical, with the exception of a modification in the mounting configuration called a "rejection feature". This feature permits Class R fuses to be mounted in rejection type fuseclips. "R" type fuseclips prevent older type Class H, ONE-TIME and RENEWABLE fuses from being installed. The use of Class R fuseholders is thus an important safeguard. The application of Class R fuses in such equipment as disconnect switches permits the equipment to have a high interrupting rating. NEC Articles 110-9 and 230-65 require that protective devices have adequate capacity to interrupt short-circuit currents. Article 240-60(b) requires fuseholders for current-limiting fuses to reject non-current-limiting type fuses.



In the above illustration, a grooved ring in one ferrule provides the rejection feature of the Class R fuse in contrast to the lower interrupting rating, non-rejection type.

Branch-Circuit Listed Fuses

Branch-circuit listed fuses are designed to prevent the installation of fuses that cannot provide a comparable level of protection to equipment.

The characteristics of Branch-circuit fuses are:

1. They must have a minimum interrupting rating of 10,000A
2. They must have a minimum voltage rating of 125V.
3. They must be size rejecting such that a fuse of a lower voltage rating cannot be installed in the circuit.
4. They must be size rejecting such that a fuse with a current rating higher than the fuseholder rating cannot be installed.

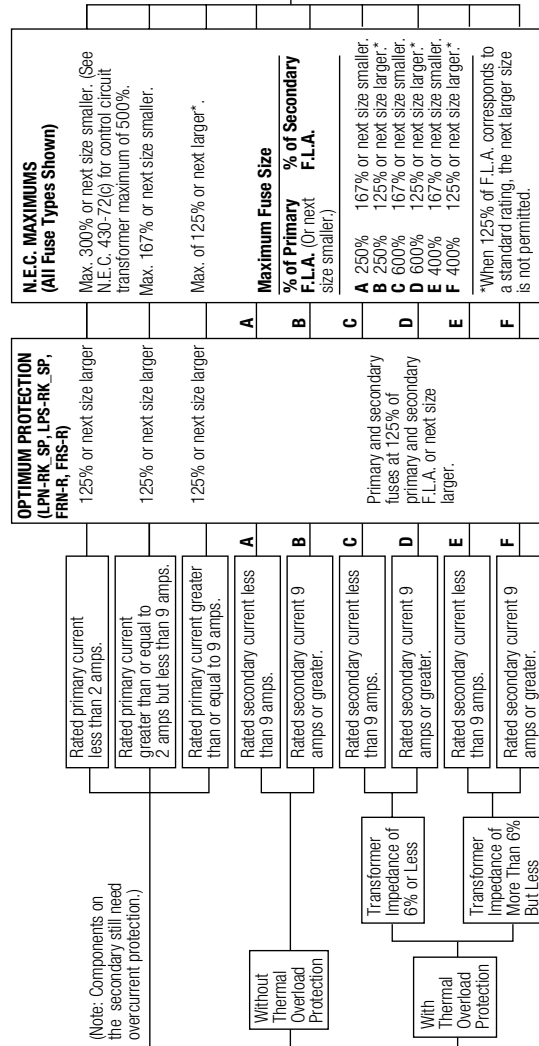
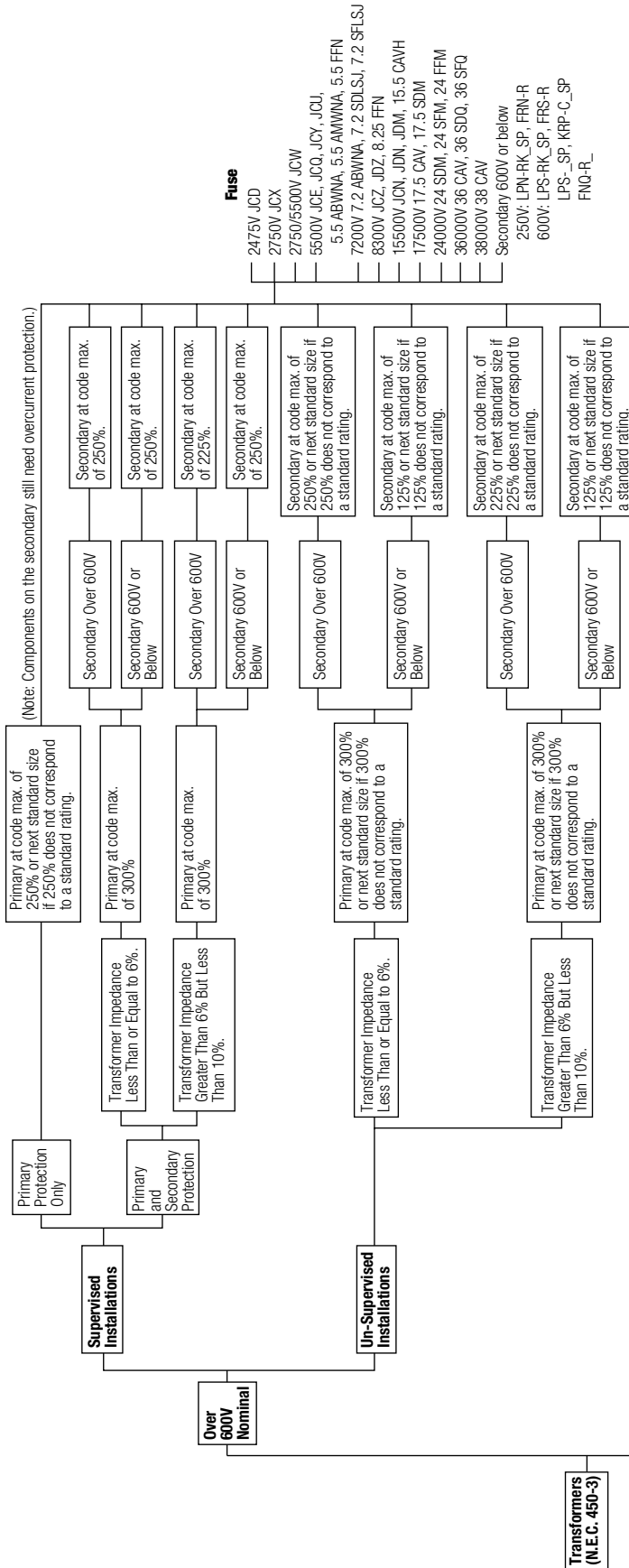

OPTIMUM PROTECTION (LPN-RK_SP, LPS-RK_SP, FRN-R, FRS-R)

125% or next size larger	A
125% or next size larger	B
125% or next size larger	C
Primary and secondary fuses at 125% of primary and secondary F.L.A. or next size larger.	D
Rated secondary current less than 9 amps.	E
Rated secondary current 9 amps or greater.	F

N.E.C. MAXIMUMS (All Fuse Types Shown)

Max. 300% or next size smaller. (See N.E.C. 430-72(c) for control circuit transformer maximum of 500%. Max. 167% or next size smaller.	Maximum Fuse Size % of Primary F.L.A. (Or next size smaller)
Max. of 125% or next larger*.	% of Secondary F.L.A.
	A 250% or next size smaller.
	B 250% or next size larger.
	C 600% or next size smaller.
	D 600% or next size larger.*
	E 400% or next size smaller.
	F 400% or next size larger.*

*When 125% of F.L.A. corresponds to a standard rating, the next larger size is not permitted.

Based on 1996 N.E.C.®

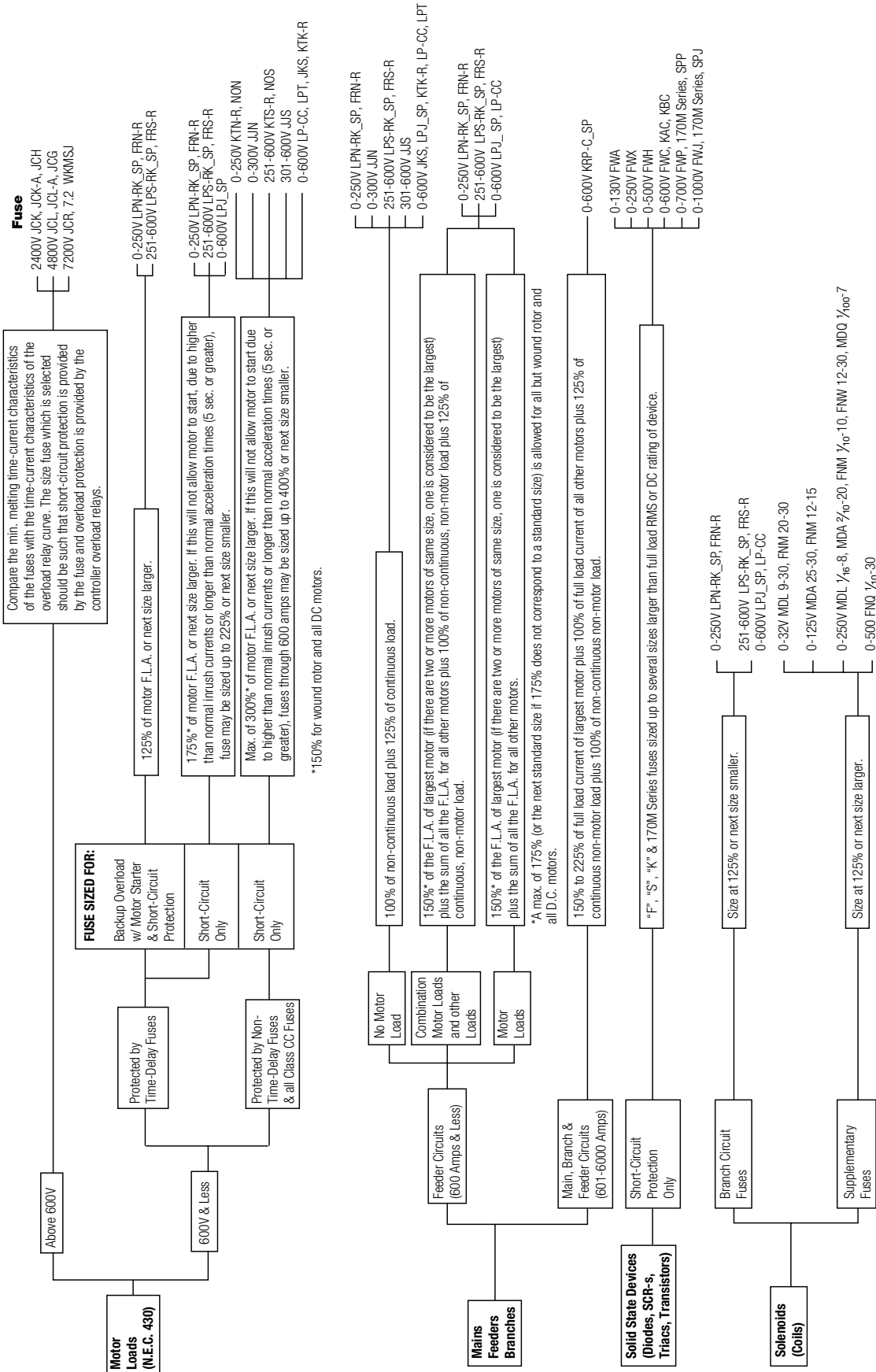

Based on 1996 N.E.C.®

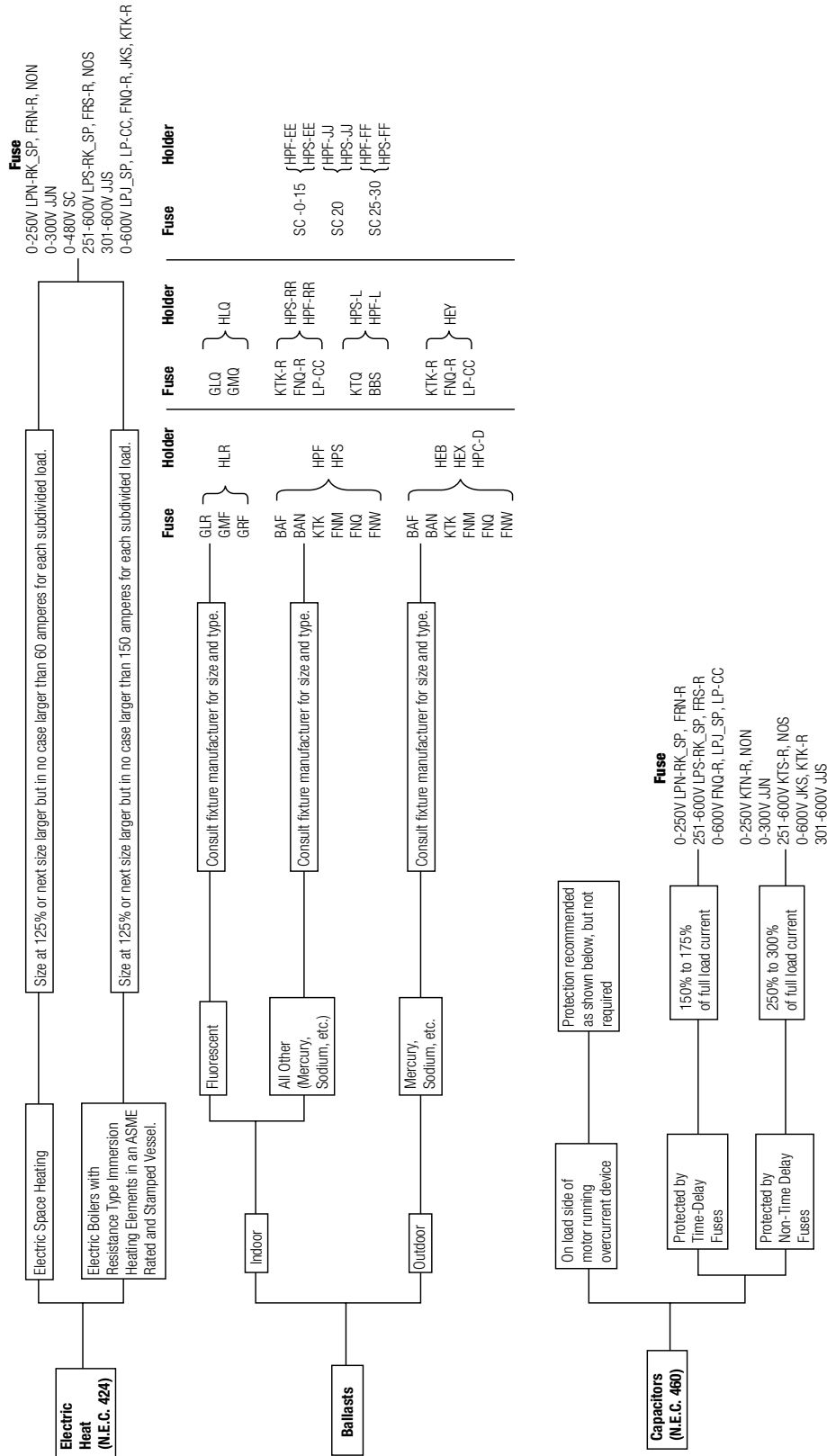

TCF & TCFH CUBEFuse™ Fuses

TCF & TCFH Time-Current Characteristic Curves—Average Melt

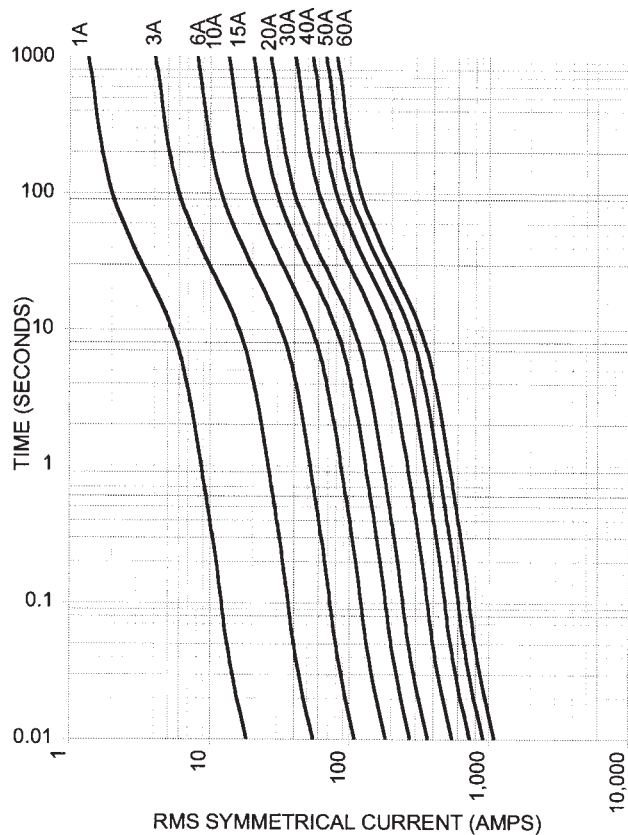

Current Limitation Curves

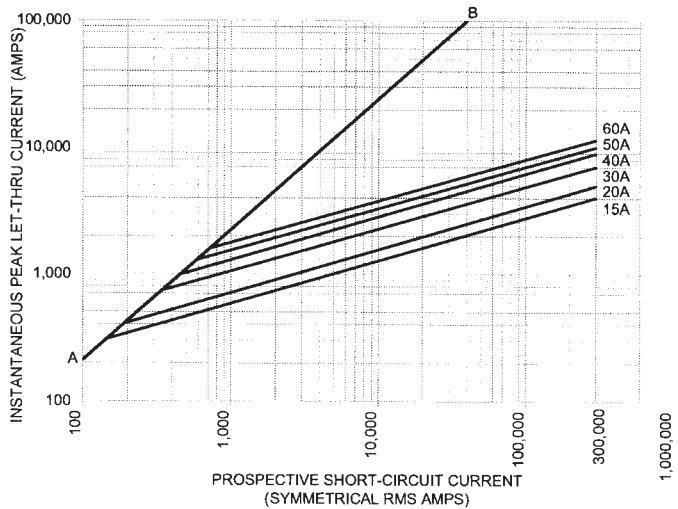

KRP-C, Class L Fuses

KRP-C Time-Current Characteristic Curves—
Average Melt

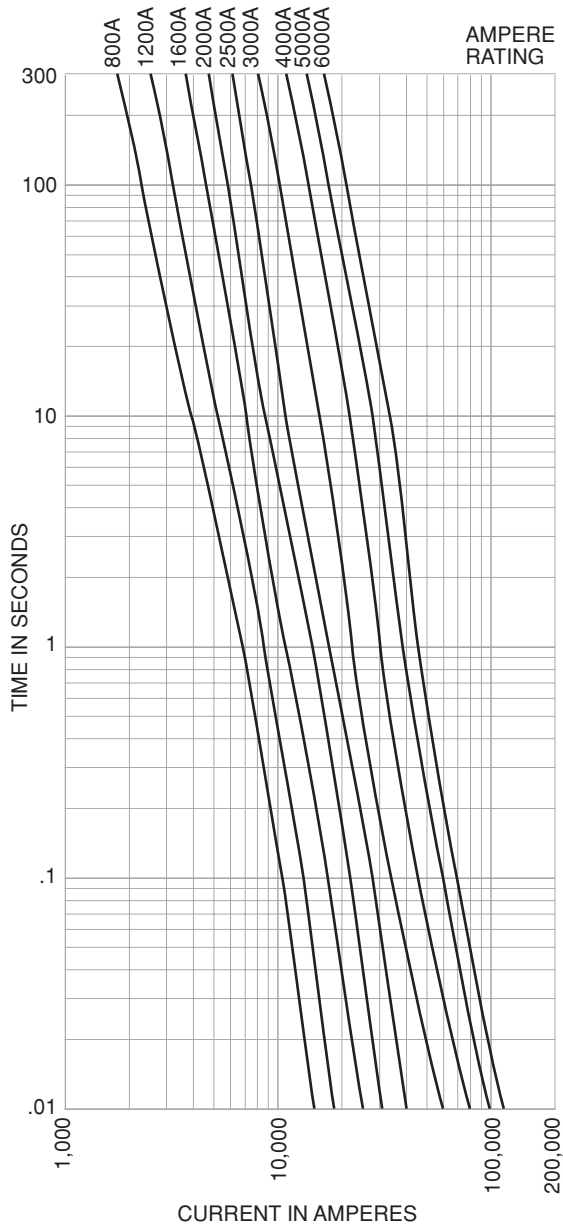

KRP-C Current Limitation Curves

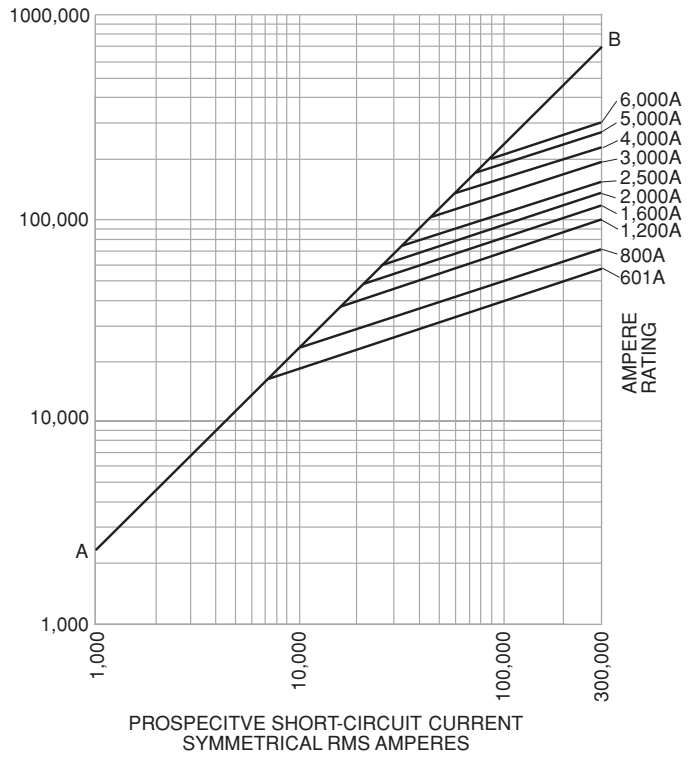

LPN-RK (250V) Class RK1 Fuses

Time-Current Characteristic Curves—Average Melt

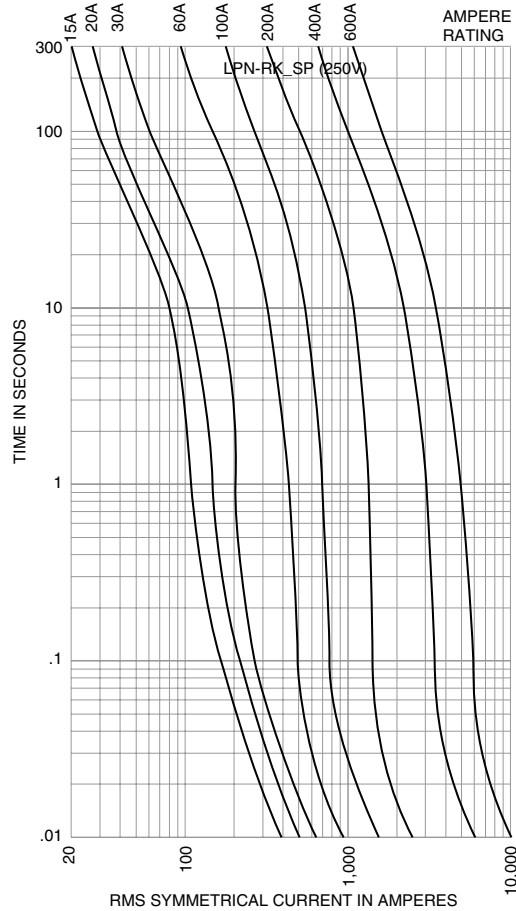

Time-Current Characteristic Curves—Average Melt

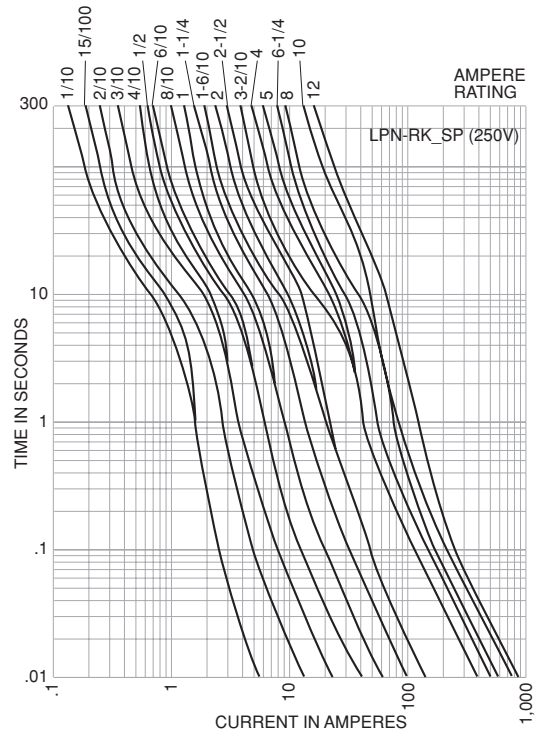

Current Limitation Curves

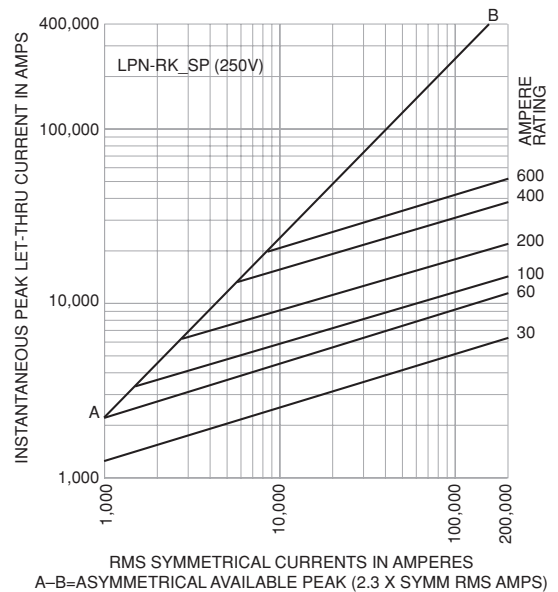

LPS-RK (600V) Class RK1 Fuses

Time-Current Characteristic Curves—Average Melt

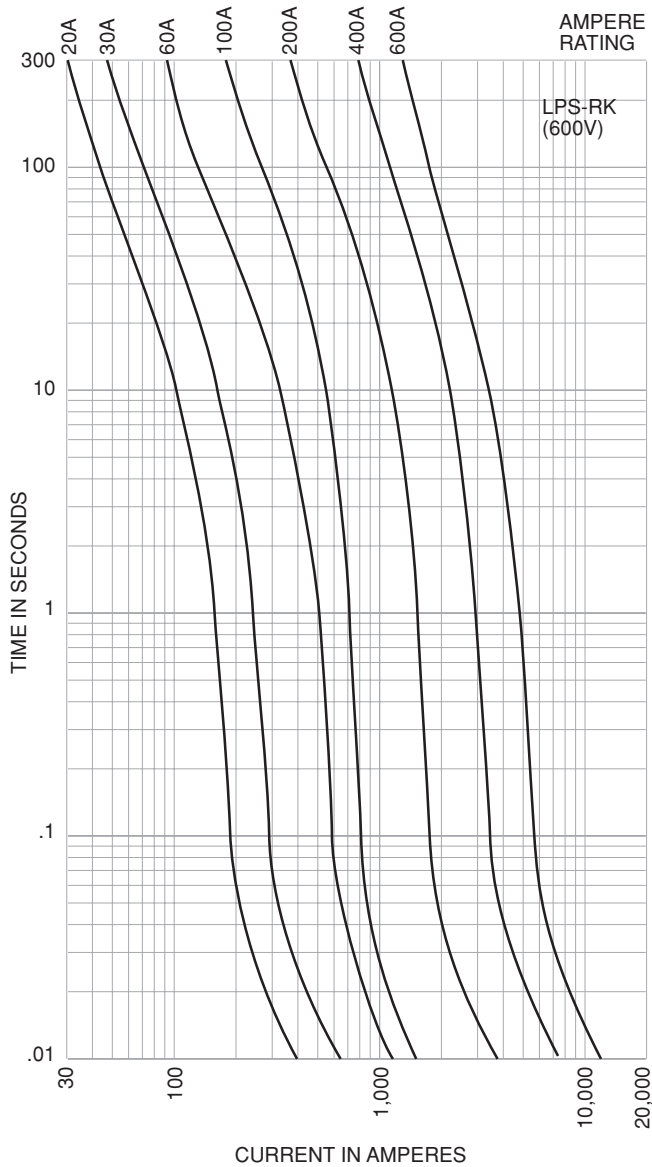

Time-Current Characteristic Curves—Average Melt

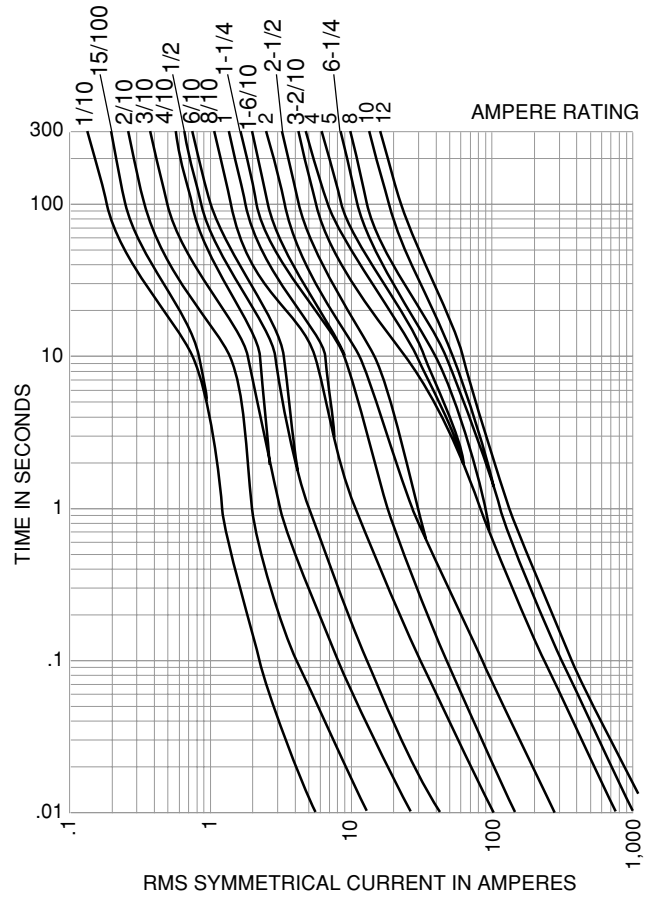

Current Limitation Curves

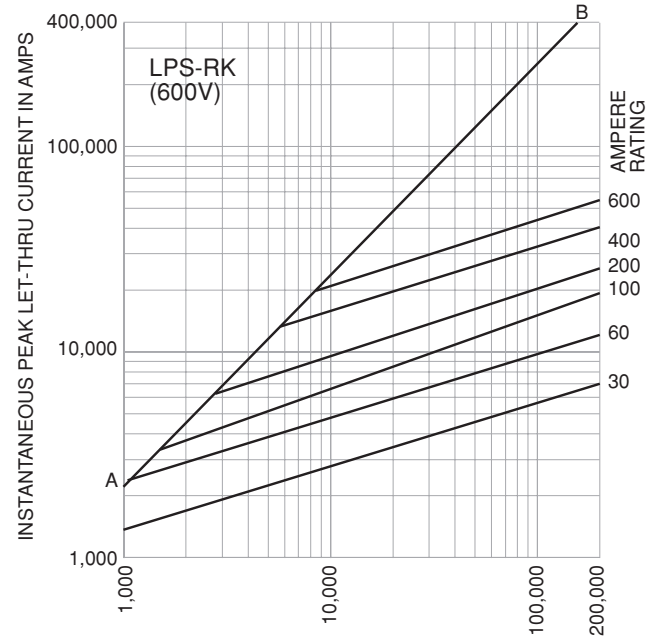

FRN-R (250V) Class RK5 Fuses

Time-Current Characteristic Curves—Average Melt

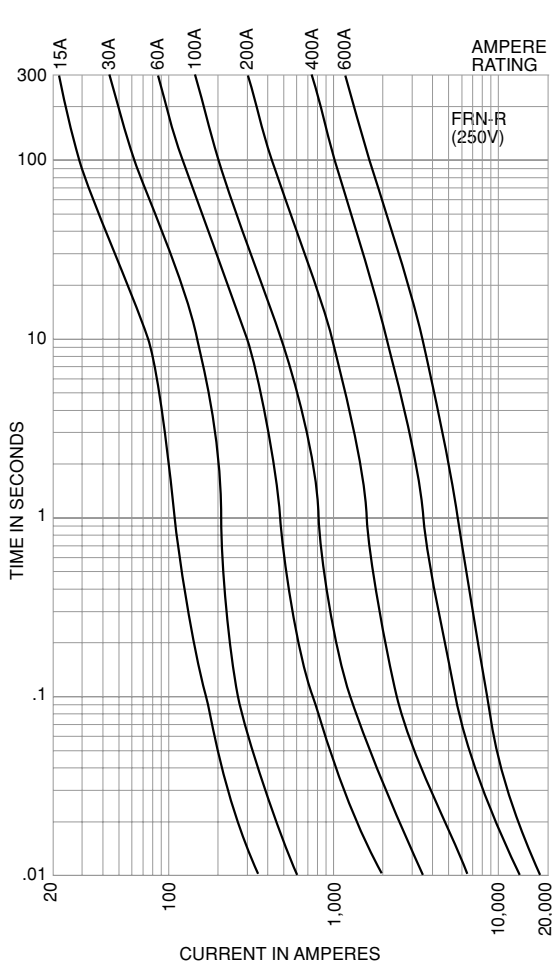

Time-Current Characteristic Curves—Average Melt

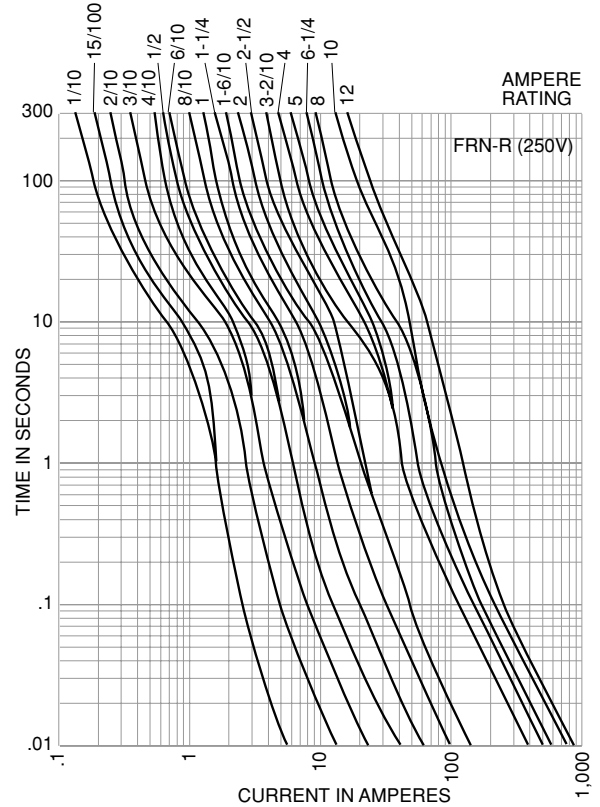

Current Limitation Curves

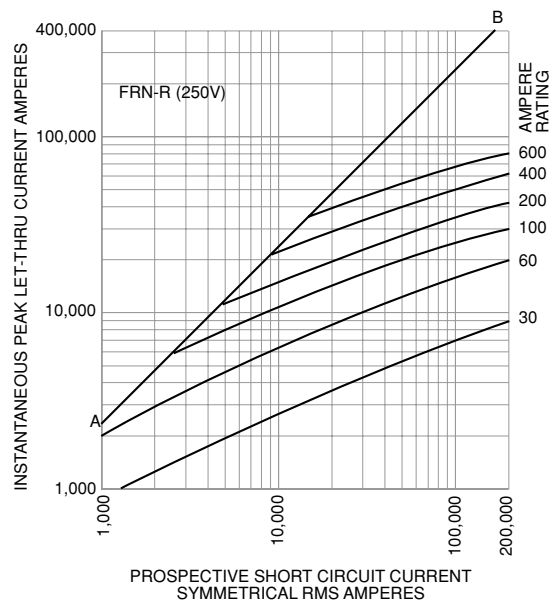

FRS-R (600V) Class RK5 Fuses

Time-Current Characteristic Curves—Average Melt

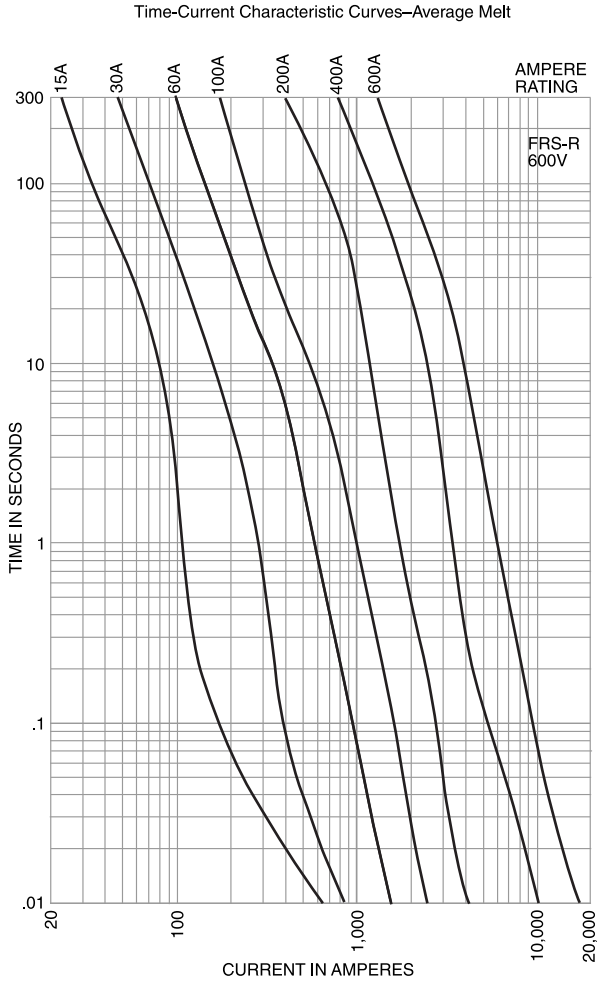

Time-Current Characteristic Curves—Average Melt

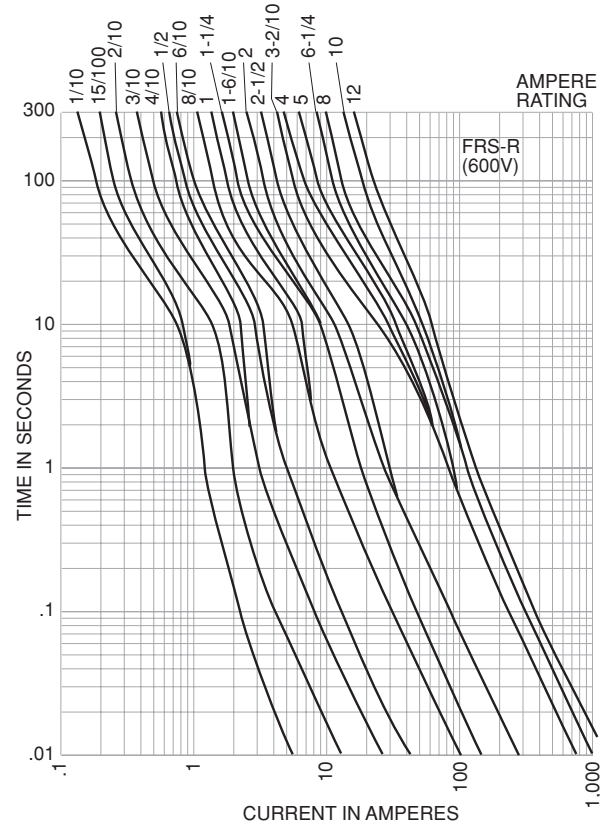

Current Limitation Curves

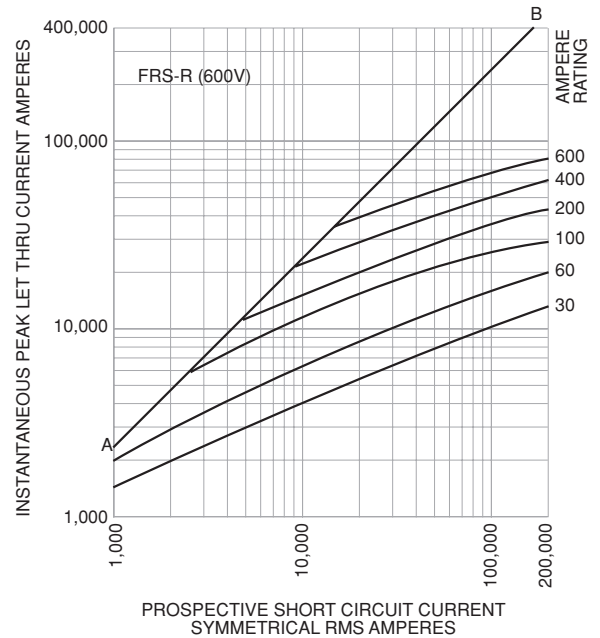

KTN-R (250V) Class RK1 Fuses

Time-Current Characteristic Curves—Average Melt

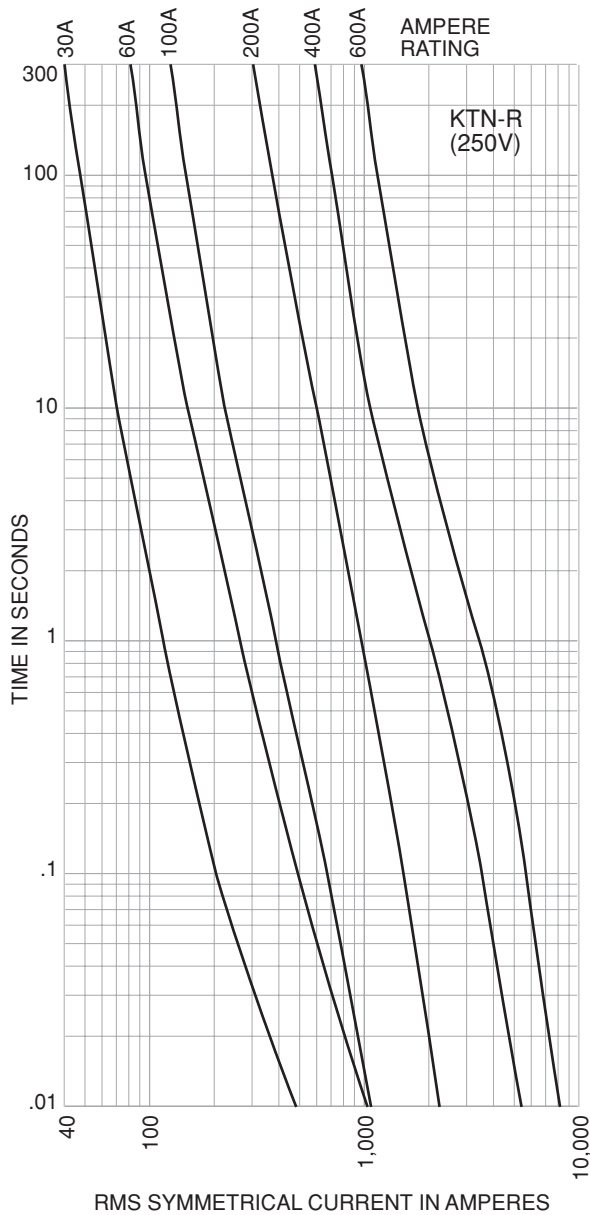

Current Limitation Curves

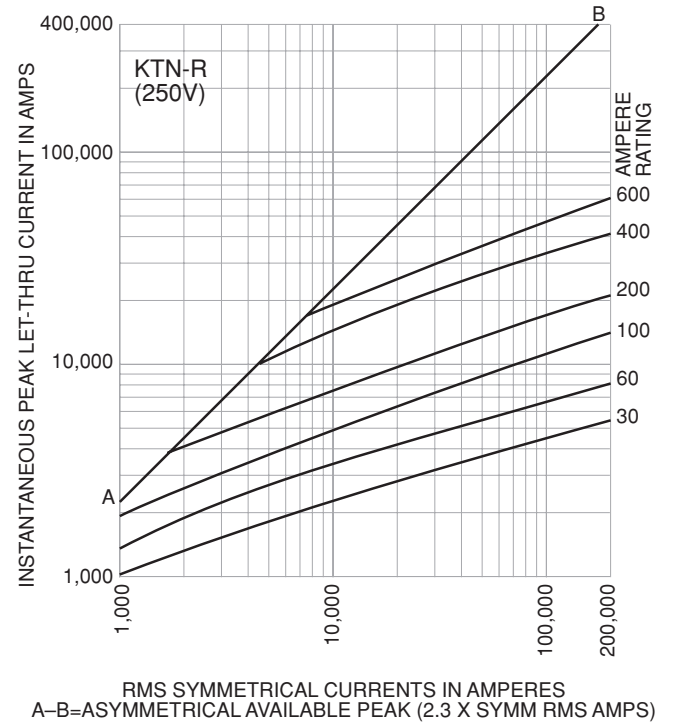

KTS-R (600V) Class RK1 Fuses

Time-Current Characteristic Curves—Average Melt

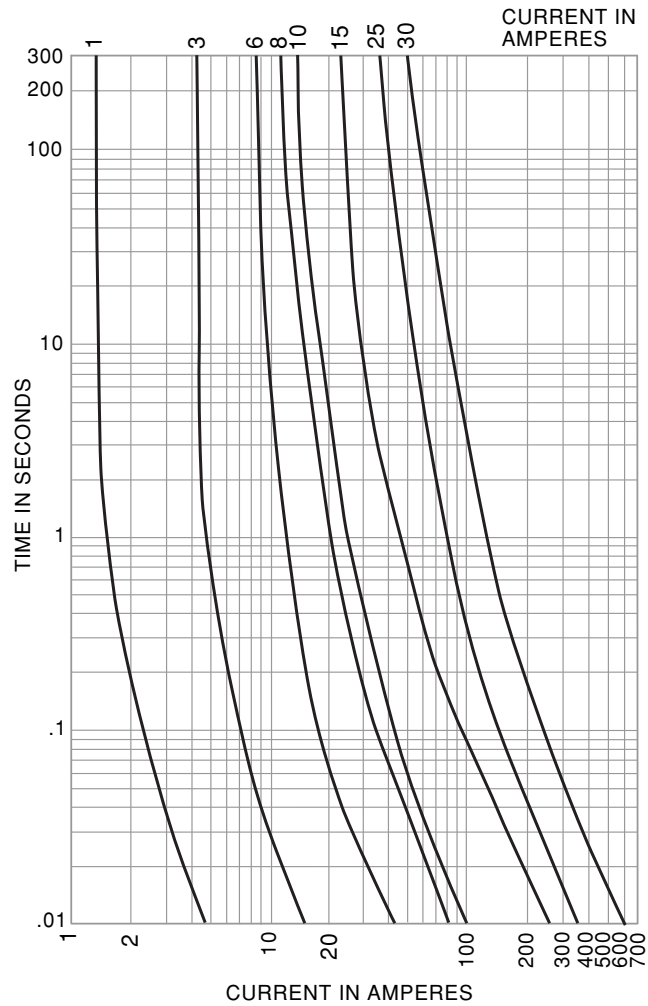

Current Limitation Curves

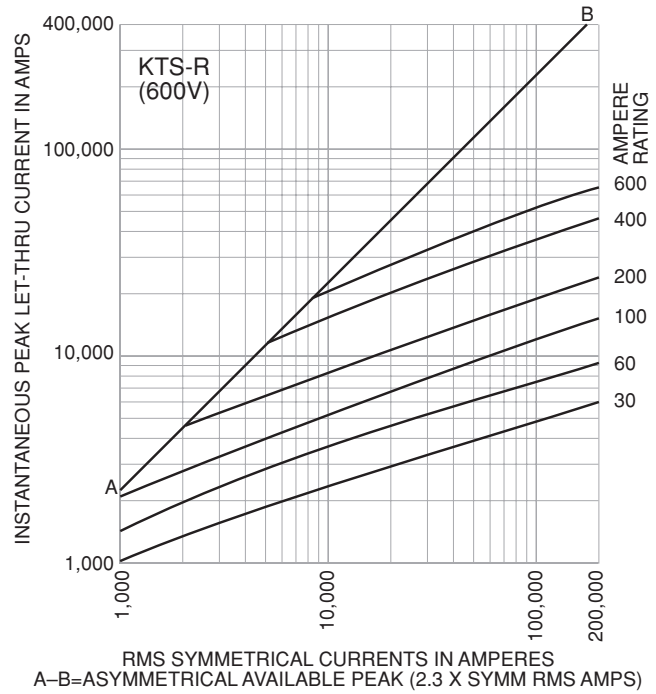

LPJ (600V), Class J Fuses

Time-Current Characteristic Curves—
Average Melt

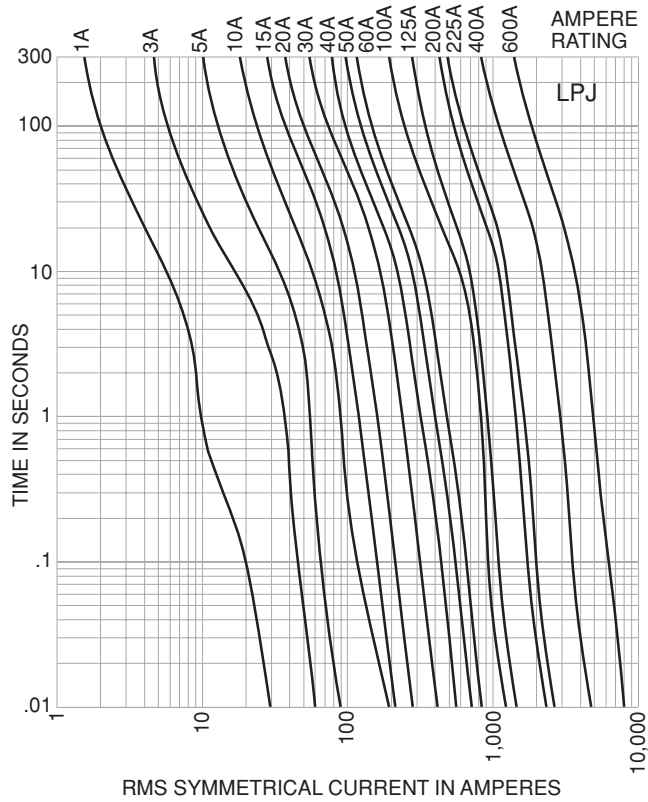

Current Limitation Curves

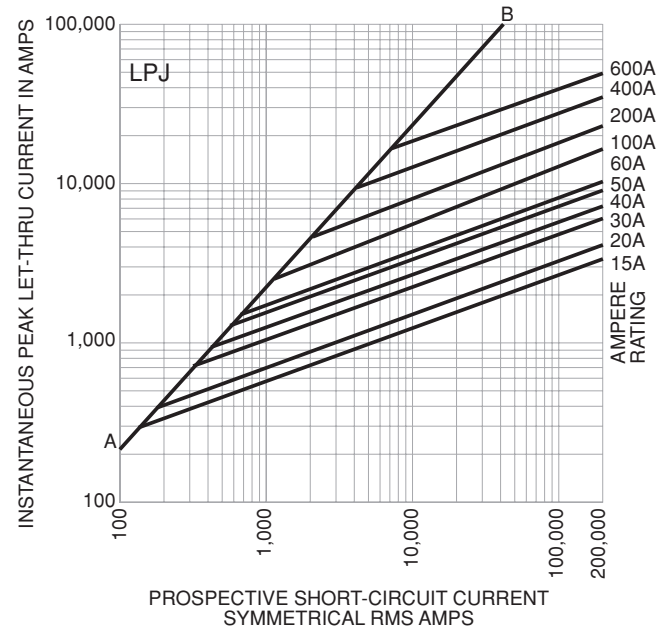

JJN & JJS, Class T Fuses

Time-Current Characteristic Curves—Average Melt

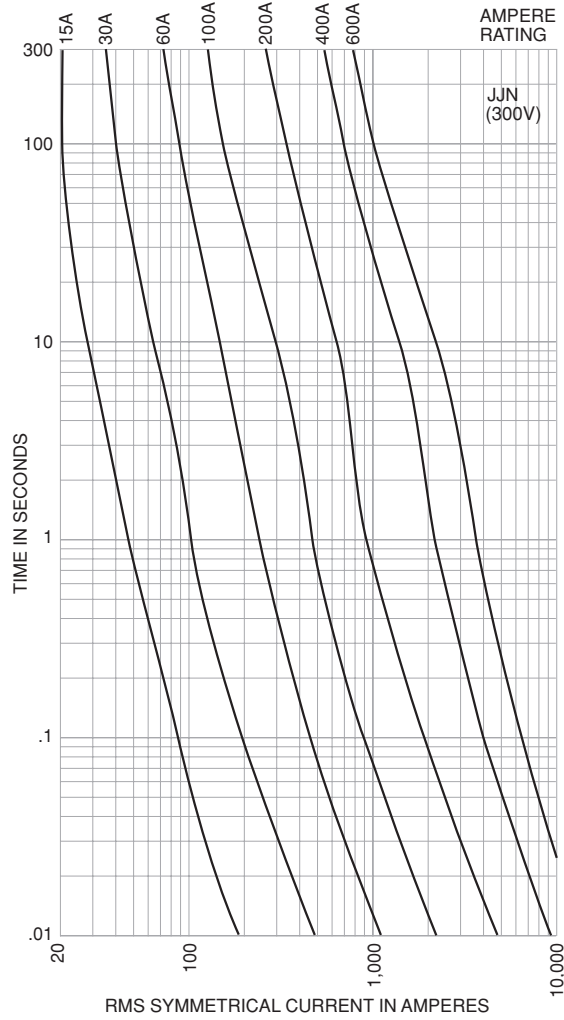

Time-Current Characteristic Curves—Average Melt

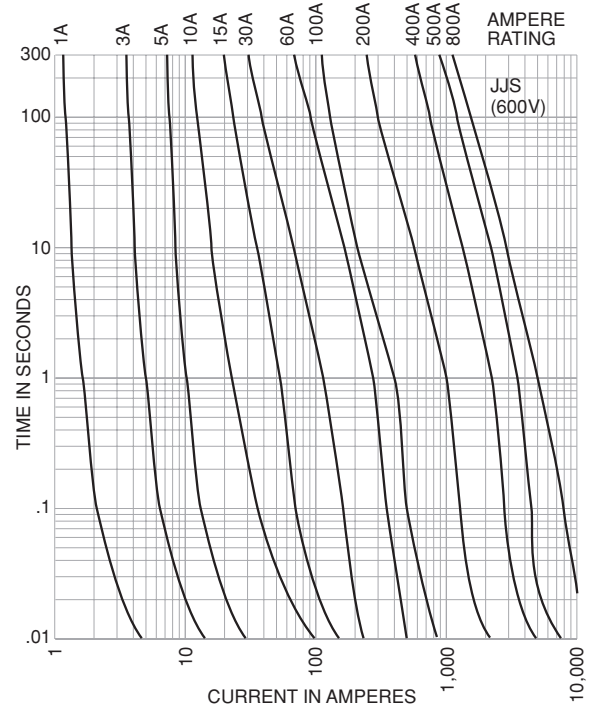

Current Limitation Curves

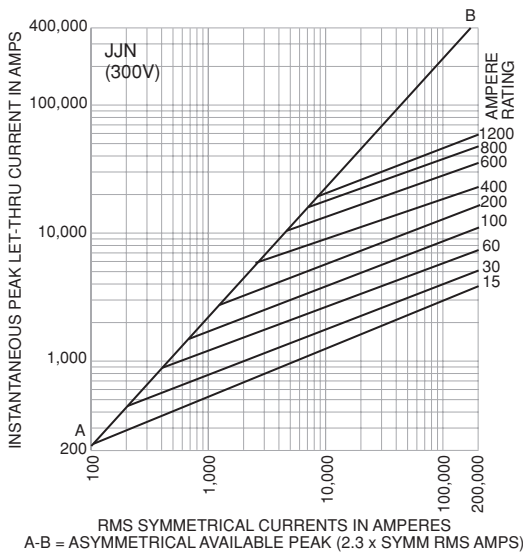

Current Limitation Curves

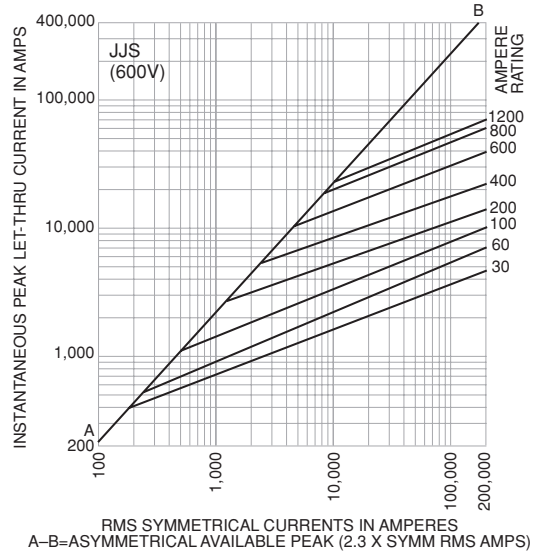

LP-CC & FNQ-R Class CC Fuses

Time-Current Characteristic Curves—Average Melt

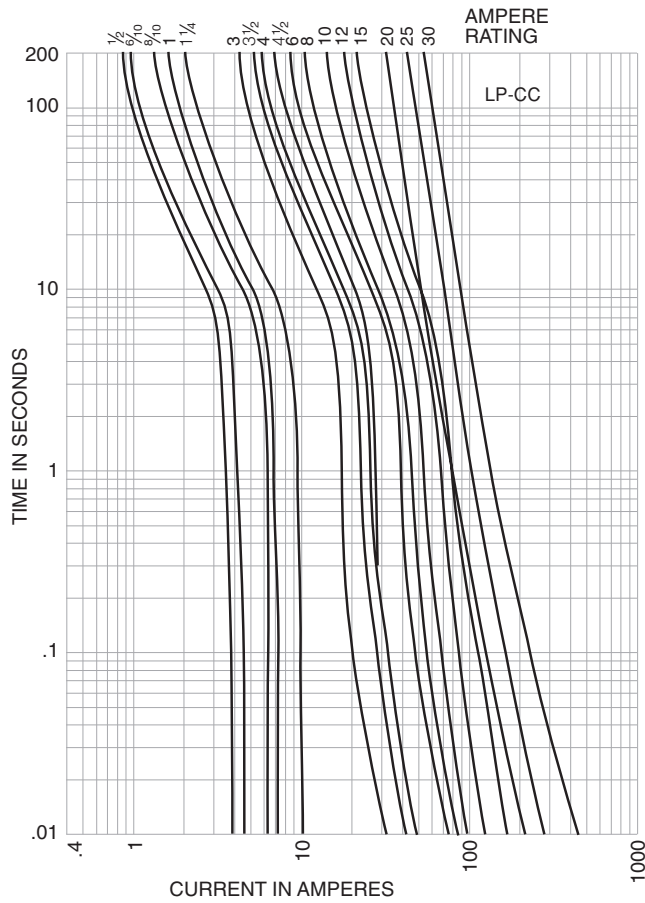

Time-Current Characteristic Curves—Average Melt

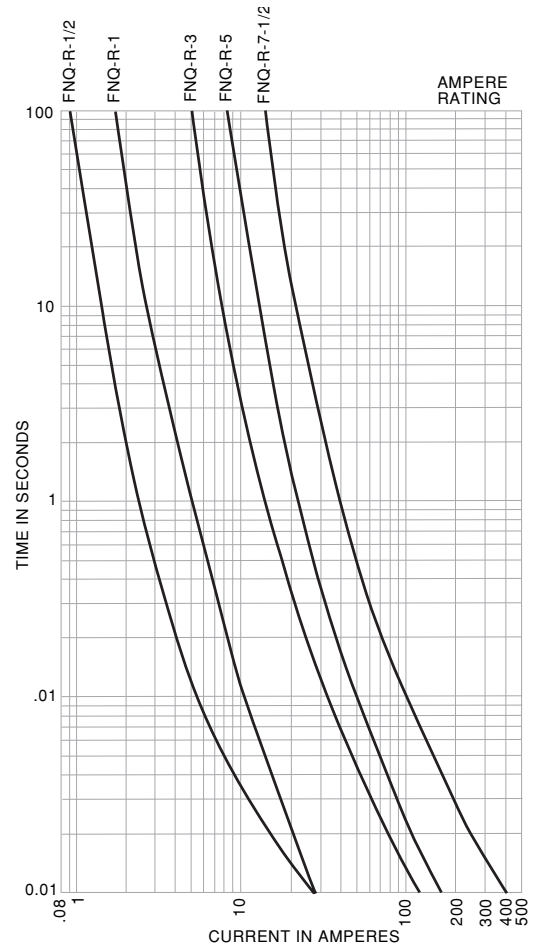

KTK-R, Class CC Fuses

Time-Current Characteristic Curves—Average Melt

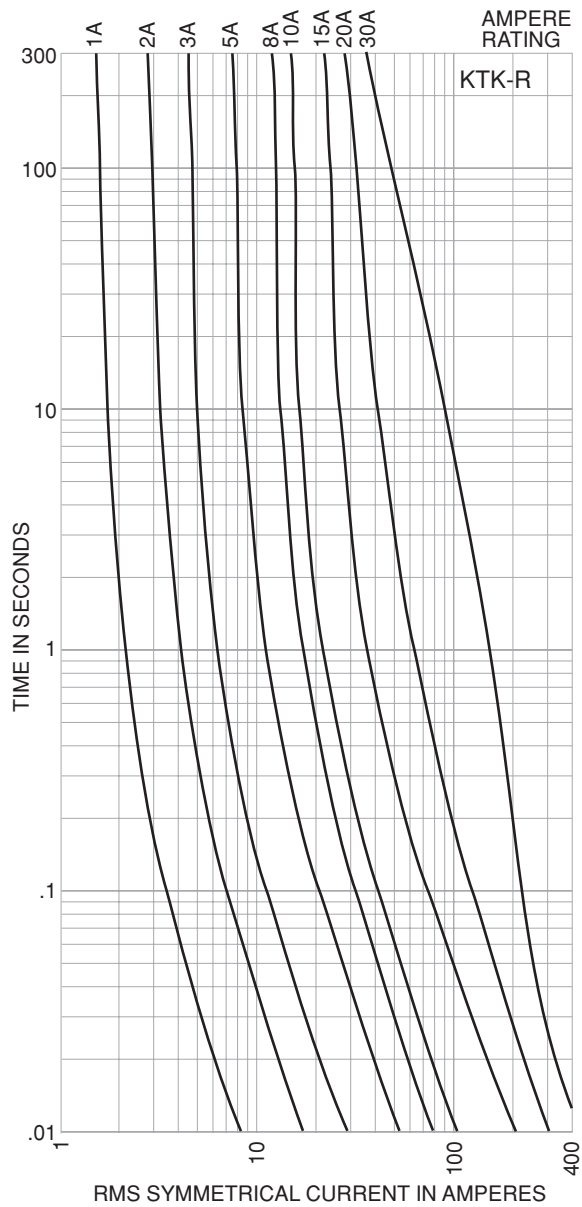

Ampere

The measurement of intensity of rate of flow of electrons in an electric circuit. An ampere is the amount of current that will flow through a resistance of one ohm under a pressure of one volt.

Ampere Rating

The current-carrying capacity of a fuse. When a fuse is subjected to a current above its ampere rating, it will open the circuit after a predetermined period of time.

Ampere Squared Seconds, I²t

The measure of heat energy developed within a circuit during the fuse's clearing. It can be expressed as "melting I²t", "arcing I²t" or the sum of them as "Clearing I²t". "I" stands for effective let-through current (RMS), which is squared, and "t" stands for time of opening, in seconds.

Arcing Time

The amount of time from the instant the fuse link has melted until the overcurrent is interrupted, or cleared.

Breaking Capacity

(See Interrupting Rating)

Cartridge Fuse

A fuse consisting of a current responsive element inside a fuse tube with terminals on both ends.

Class CC Fuses

600V, 200,000A interrupting rating, branch circuit fuses with overall dimensions of $1\frac{3}{32}$ " x $1\frac{1}{2}$ ". Their design incorporates a rejection feature that allows them to be inserted into rejection fuse holders and fuse blocks that reject all lower voltage, lower interrupting rating $1\frac{3}{32}$ " x $1\frac{1}{2}$ " fuses. They are available from $\frac{1}{10}$ A through 30A.

Class G Fuses

480V, 100,000A interrupting rating branch circuit fuses that are size rejecting to eliminate overfusing. The fuse diameter is $1\frac{3}{32}$ " while the length varies from $1\frac{5}{16}$ " to $2\frac{1}{4}$ ". These are available in ratings from 1A through 60A.

Class H Fuses

250V and 600V, 10,000A interrupting rating branch circuit fuses that may be renewable or non-renewable. These are available in ampere ratings of 1 amp through 600A.

Class J Fuses

These fuses are rated to interrupt a minimum of 200,000A ac. They are labelled as "Current-Limiting", are rated for 600vac, and are not interchangeable with other classes.

Class K Fuses

These are fuses listed as K-1, K-5, or K-9 fuses. Each subclass has designated I²t and I_p maximums. These are dimensionally the same as Class H fuses, and they can have interrupting ratings of 50,000, 100,000, or 200,000 A. These fuses are current-limiting. However, they are not marked "current-limiting" on their label since they do not have a rejection feature.

Class L Fuses

These fuses are rated for 601 through 6000A, and are rated to interrupt a minimum of 200,000A ac. They are labelled "Current-Limiting" and are rated for 600Vac. They are intended to be bolted into their mountings and are not normally used in clips. Some Class L fuses have designed in time-delay features for all purpose use.

Class R Fuses

These are high performance fuses rated $\frac{1}{10}$ -600A in 250V and 600V ratings. All are marked "Current Limiting" on their label and all have a minimum of 200,000A interrupting rating. They have identical outline dimensions with the Class H fuses but have a rejection feature which prevents the user from mounting a fuse of lesser capabilities (lower interrupting capacity) when used with special Class R Clips. Class R fuses will fit into either rejection or non-rejection clips.

Class T Fuses

An industry class of fuses in 300V and 600V ratings from 1 amp through 1200A. They are physically very small and can be applied where space is at a premium. They are fast acting and time-lag fuses, with an interrupting rating of 200,000A RMS.

Classes of Fuses

The industry has developed basic physical specifications and electrical performance requirements for fuses with voltage ratings of 600V or less. These are known as standards. If a type of fuse meets the requirements of a standard, it can fall into that class. Typical classes are K, RK1, RK5, G, L, H, T, CC, and J.

Clearing Time

The total time between the beginning of the overcurrent and the final opening of the circuit at rated voltage by an overcurrent protective device. Clearing time is the total of the melting time and the arcing time.

Current Limitation

A fuse operation relating to short circuits only. When a fuse operates in its current-limiting range, it will clear a short circuit in less than $\frac{1}{2}$ cycle. Also, it will limit the instantaneous peak let-through current to a value substantially less than that obtainable in the same circuit if that fuse were replaced with a solid conductor of equal impedance.

Dual Element Fuse

Fuse with a special design that utilizes two individual elements in series inside the fuse tube. One element, the spring actuated trigger assembly, operates on overloads up to 5-6 times the fuse current rating. The other element, the short circuit section, operates on short circuits up to their interrupting rating.

Electrical Load

That part of the electrical system which actually uses the energy or does the work required.

Fast Acting Fuse

A fuse which opens on overload and short circuits very quickly. This type of fuse is not designed to withstand temporary overload currents associated with some electrical loads.

Fuse

An overcurrent protective device with a fusible link that operates and opens the circuit on an overcurrent condition.

High Speed Fuses

Fuses with no intentional time-delay in the overload range and designed to open as quickly as possible in the short-circuit range. These fuses are often used to protect solid-state devices.

Inductive Load

An electrical load which pulls a large amount of current—an inrush current—when first energized. After a few cycles or seconds the current "settles down" to the full-load running current.

Interrupting Capacity

See Interrupting Rating

Interrupting Rating**(Breaking Capacity)**

The rating which defines a fuse's ability to *safely* interrupt and clear short circuits. This rating is much greater than the ampere rating of a fuse. The NEC® defines Interrupting Rating as "The highest current at rated voltage that an overcurrent protective device is intended to interrupt under standard test conditions."

Melting Time

The amount of time required to melt the fuse link during a specified overcurrent. (See Arcing Time and Clearing Time.)

"NEC" Dimensions

These are dimensions once referenced in the National Electrical Code. They are common to Class H and K fuses and provide interchangeability between manufacturers for fuses and fusible equipment of given ampere and voltage ratings.

Ohm

The unit of measure for electric resistance. An ohm is the amount of resistance that will allow one ampere to flow under a pressure of one volt.

Ohm's Law

The relationship between voltage, current, and resistance, expressed by the equation $E = IR$, where E is the voltage in volts, I is the current in amperes, and R is the resistance in ohms.

One Time Fuses

Generic term used to describe a Class H nonrenewable cartridge fuse, with a single element.

Overcurrent

A condition which exists on an electrical circuit when the normal load current is exceeded. Overcurrents take on two separate characteristics—overloads and short circuits.

Overload

Can be classified as an overcurrent which exceeds the normal full load current of a circuit. Also characteristic of this type of overcurrent is that it does not leave the normal current carrying path of the circuit—that is, it flows from the source, through the conductors, through the load, back through the conductors, to the source again.

Peak Let-Through Current, I_p

The instantaneous value of peak current let-through by a current-limiting fuse, when it operates in its current-limiting range.

Renewable Fuse (600V & below)

A fuse in which the element, typically a zinc link, may be replaced after the fuse has opened, and then reused. Renewable fuses are made to Class H standards.

Resistive Load

An electrical load which is characteristic of not having any significant inrush current. When a resistive load is energized, the current rises instantly to its steady-state value, without first rising to a higher value.

R.M.S. Current

The R.M.S. (root-mean-square) value of any periodic current is equal to the value of the direct current which, flowing through a resistance, produces the same heating effect in the resistance as the periodic current does.

Semiconductor Fuses

Fuses used to protect solid-state devices. See "High Speed Fuses".

Short Circuit

Can be classified as an overcurrent which exceeds the normal full load current of a circuit by a factor many times (tens, hundreds or thousands greater). Also characteristic of this type of overcurrent is that it leaves the normal current carrying path of the circuit—it takes a "short cut" around the load and back to the source.

Short-Circuit Rating

The maximum short-circuit current an electrical component can sustain without the occurrence of excessive damage when protected with an overcurrent protective device.

Short-Circuit Withstand Rating

Same definition as short-circuit rating.

Single Phasing

That condition which occurs when one phase of a three phase system opens, either in a low voltage (secondary) or high voltage (primary) distribution system. Primary or secondary single phasing can be caused by any number of events. This condition results in unbalanced currents in polyphase motors and unless protective measures are taken, causes overheating and failure.

Threshold Current

The symmetrical RMS available current at the threshold of the current-limiting range, where the fuse becomes current-limiting when tested to the industry standard. This value can be read off of a peak let-through chart where the fuse curve intersects the A-B line. A threshold ratio is the relationship of the threshold current to the fuse's continuous current rating.

Time-Delay Fuse

A fuse with a built-in delay that allows temporary and harmless inrush currents to pass without opening, but is so designed to open on sustained overloads and short circuits.

Voltage Rating

The maximum open circuit voltage in which a fuse can be used, yet safely interrupt an overcurrent. Exceeding the voltage rating of a fuse impairs its ability to clear an overload or short circuit safely.

Withstand Rating

The maximum current that an unprotected electrical component can sustain for a specified period of time without the occurrence of extensive damage.

Index by Part Number

Catalog Symbol	Page	Catalog Symbol	Page	Catalog Symbol	Page	Catalog Symbol	Page	Catalog Symbol	Page
AAO	196	C515	29	FL11H_ _	173	HHM	87	J60060	53, 54
ABC	34	C517	29	FL11K_ _	173	HHT	77	J60100	53, 54
ABCNA	170	C518	29	FL11T_ _	173	HHX	82	J60200	53, 54
ABFNA	170	C519	29	FM	149-150	HJL	75	J60400	53, 54
ABGNA	170	C520	29	FMM	149-150	HK	75	J60600	53, 54
ABWNA	170	C5268	130, 150	FNA	37	HKL	75	J70100	56
AC	197	C60F	199	FNM	25	HKP	72	JCD	166
AD	197	CAV	170	FNQ	25	HKR	75	JCE	166
ADLSJ	169	CAVH	170	FNQ-R	22	HKT	75	JCG	161, 163
ADOSJ	169	CD	197	FP	202	HKU	75	JCH	161, 162
AGA	32	CDAUX	103	FR-1000	205	HKX	75	JCI	166
AGC	34	CDBY	109	FRN-R	12, 205	HLD	75	JCK	162, 162
AGU	36	CDH 100, 102, 108, 110, 114		FRS-R	13, 205	HLQ	39	JCL	161, 162, 163
AGW	32	CDHX 101-102, 109, 111		FSD	209	HLR	39	JCQ	166
AGX	32	CDHXB 104, 114		FT	202	HLS	186	JCR	161, 163
AMWNA	170	CDHXY 104, 114		FWA	124, 151	HLT	186	JCT	166
ANL	38	CDHZX 110		FWC	153	HM	77	JCU	168
ANN	38	CDMC 109		FWH	33, 126, 152	HME	77	JCW	166
ATC	40	CDN 189		FWJ	129, 155	HMF	77	JCX	167
ATM	40	CDNF 106, 108, 110		FWK	154	HMG	77	JCY	167
BAF	24	CDS 100-101, 108-109, 186		FWL	155	HMH	77	JCZ	168
BAN	24	CDSWM 109		FWP	128, 153-154	HMI	77	JDZ	168
BAO	196	CEO 196		FWS	155	HMJ	77	JJN	19
BBS	23	CFC 103		FWX	125, 152	HPC-D	79	JJS	19
BBU	157-158	CFD 99, 100, 101, 103, 102		G	64	HPD	78	JKS	18
BC	197	CFTS 103		GBA	37	HPF	78	JP60030	55
BC6031	64	CFZ 103		GBB	35	HPG	78	JT(N)60030	57, 58
BC6032	64	CGL 190		GDA	30	HPM	79	JT(N)60060	57, 58
BC6033	64	CH 65		GDB	30	HPS	78	K	28
BCCM	64	CIF06 191		GDC	30	HPS2	79	K07C	194
BD	197	CIF21 191		GF	197	HR	77	KAC	127
BDAUX	112	CIH 194		GG	197	HRC	195, 199	KAZ	38
BDH 101-102, 104, 109, 111, 114		CIK 194		GH	197	HRE	77	KBC	127
BDNF 107, 111		CIL 194		GLD	37	HRF	77	KCA	28
BDS 102, 104, 105, 111		CJ 192		GLQ	39	HRG	77	KCB	28
BDST 102		CM_ _CF 194		GLR	39	HRH	77	KCC	28
BDA 103, 105		CS/XMAS 2048		GMA	31	HRI	77	KCD	28
BDTL 103, 104, 105, 112		CT 149		GMC	31	HRJ	77	KCE	28
BDTS 112		DD 197		GMD	31	HRK	76	KCF	28
BDZX 112		DEO 196		GMF	39	HTB	73, 74	KCH	28
BG	64	DIN 132-138		GMQ	39	HTC-140M	85	KCJ	28
BG3011	64	DLN-R 14		GMT 186		HTC-15M	85	KCM	28
BG3012	64	DLS-R 14		GRF 39		HTC-200M	85	KCR	28
BG3013	64	ECL055 159		H07C 194		HTC-210M	85	KCS	28
BG3021	64	ECL155 160		H25_ _ _ 47		HTC-30M	71	KCY	28
BG3022	64	ED 197		H60_ _ _ 48		HTC-35M	71	KCZ	28
BG3023	64	EDA 27		HBH 70		HTC-40M	71	KDA	28
BG3031	64	EET 149-150		HBV 70		HTC-45M	69	KDB	28
BG3032	64	EF 1937		HBW 70		HTC-50M	69	KDC	28
BG3033	64	EFC 113-116		HEB 80, 81		HTC-55M	71	KDD	28
BH-0_ _ _ 67, 130, 147		EFJ 113-116		HEC 80		HTC-60M	69	KDE	28
BH-1_ _ _ 67, 130, 147		EFL 113-114, 116		HEG 80		HTC-65M	69	KDF	28
BH-2_ _ _ 67, 130, 147		EFS 197		HEH 80		HTC-70M	71	KDH	28
BH-3_ _ _ 67, 130, 147		EK 191		HEJ 80		HVA 171		KDJ	28
BM 64		ENA 27		HET 80		HVB 171		KDM	28
BM6031	64	ENF 117-120		HEX 80		HVJ 171		KDP	28
BM6032	64	ERK-28 206		HEY 80		HVL 171		KDR	28
BM6033	64	ESD 196		HFA 77		HVR 171		KDT	28
BNQ21-WH 93		ET 149-150		HFB 76		HVT 171		KDY	28
BP/AGX 208		FD 99, 104		HHB 76		HVU 171		KEW	28
BP/GLH 208		FDM 209		HHC 82		HVV 171		KEX	28
BP/MAS 208		FE 149-150		HHD 82		HVX 171		KFH-A	28
BP/XMAS 208		FEE 149-150		HHF 82		IBS 150		KFM	28
BQQ41-WH 93		FF 197		HHG 82		J- _ _ 203		KFT	28
C30F 199		FG 197		HHL 82		J60030	53, 54	KFZ	28

Index by Part Number

Catalog Symbol	Page	Catalog Symbol	Page	Catalog Symbol	Page	Catalog Symbol	Page	Catalog Symbol	Page
KIG	28	No. 140	207	R25600	47, 48, 49	TP15914	177	2601	63
KLM	24	No. 2	204	R60030	50, 51, 52	TPA	178	2602	63
KLU	8	No. 200	208	R60060	50, 51, 52	TPA-B	178	2604	63
KPF	28	No. 201	208	R60100	50, 51, 52	TPC & TPCDS	175	2605	63
KQO	28	No. 205	208	R60200	50, 51, 52	TPHCS	182	2607	63
KQT	28	No. 213	203	R60400	50, 51, 52	TPL	183	2608	63
KQV	28	No. 216	203	R60600	50, 51, 52	TPC & TPCDS	176	2610	63
KRP-CL	7	No. 220	207	S	26	TPN	184	2611	63
KRP-C_SP	6	No. 226	203	S-8001	83	TPS	179	2960	171
KT3	92	No. 242	203	SA	27	TPSFH	202	2NZ01	198
KT4	92	No. 2621	203	SAMI	46	TYPE D (_D_ _)	198	3723	66
KTK	24	No. 263	203	SB	201	VFNHA	164	3742	66
KTK-R	22	No. 2641	203	SC	20	VKNHA	164	3743	66
KTN-R	15	No. 2642	203	SCY	68	VLB	201	3828	84
KTQ	23	No. 2661	203	SDLSJ	169	W	26	3835	66
KTS-R	15	No. 2662	203	SDMSJ	169	WDFHO	164	4393	84
KTU	8	No. 2664	203	SDQSJ	169	WDLSJ	164, 169	4421	66
L09C	195	No. 270	207	SFC	202	WDOH6	164	4515	66
L14C	195	No. 2880	208	SFLSJ	169	WDOSJ	169	4520	84
LBS	201	No. 36	206	SFMSJ	169	WER	187	4528	171
LCT	148	No. 4	204	SFQSJ	169	WFFHO	164	4529	171
LET	148, 150	No. 5	204	SKA	68	WFLSJ	164, 169	4530	171
LMMT	148, 150	No. 6	204	SKLSJ	169	WFMSJ	164	4574	83
LMT	148, 150	No. 626	203	SKMSJ	169	WFNHO	164	4NZ01	198
LP-CC	21	No. 7	204	SL	26	WFOH6	164	5591	88
LPJ_SP	17	No. 8	204	SOA72	91	WJON6	164	5592	88
LPN-RK_SP	9	No. 15	205	SOU	68	WKFHO	164	5672	88
LPRK-28	20	NON	16	SOW	68	WKLSJ	169	5674	88
LPS-RK_SP	9	NOS	16	SOX	68	WKMSJ	164, 169	5681	88
M09C	195	NRA	91	SOY	68	WKNHO	164	5682	88
M14C	195	NSD	196	SOY-B	68	11 Type	187	5956	88
MAX	40	NSE3	91	SRU	68	11239	63	5960	88
MDA	36	NSS3	91	SRW	68	11240	63	5TPH	202
MDL	35	NTN-R	203	SRX	68	11241	63	6NZ01	197
MDQ	36	NTQ23-WH	94	SRY	68	11242	63	64000	28
MIC	37	NTS-R	203	SSD	196	11675	95	64200	28
MIN	37	NZ_ _ _	198	SSU	68	11725	95	64300	28
MIS	38	OEFMA	172	SSW	68	14002	95	64400	28
MMT	149	OEGMA	172	SSX	68	14004	95	64600	28
MT	149	OHFMA	172	SSY	68	15087	185	68000	28
MV055	165	OHGMA	172	SSY-L	68	15100	178	68150	28
MV155	165	OLGMA	172	SSY-RL	68	15149	121	68200	28
N512	91	OPM-1038	44	STD	196	15200	178	68300	28
NC3	91	OPM-NG-SC3	41, 42	STY	68	15800	177	68400	28
NDN	91	OPM-NG-SM3	41, 42	T	26	160_ _ _	96	68600	28
NDN1	90	OPM-SW	45	T30030	59, 60	162_ _ _	96	7 Type	187
NDN111	90	OPMRH	109	T30060	59, 60	163_ _ _	96, 97, 98	70 Series	185
NDN3	89	OSD	196	T30100	59, 60	165_ _ _	96, 97	74 Type	188
NDN63	89	P09C	195	T30200	59, 60	170H_ _ _ _	146-147	75 Type	188
NDNA	90, 103	P11C	195	T60030	61, 62	170M_ _ _ _	132-145	76 Type	188
NDNAS	91	PCT	187	T60060	61, 62	1A1119	86	8000	83
NDNF1	94	PFD-948	205	T60100	61, 62	1A1120	86	80 Type	188
NDNLFD1	94	PLK3	92	T60200	61, 62	1A1907	86	81 Type	187
NDNV4	89	PLU1	92	T60400	61, 62	1A3398	86		
NFT2	91	PLU3	92	T60600	61, 62	1A3399	85		
NFT3	91	PMP	122	TB	1201	1A3400	87		
NFTA	91	PON	189	TCF	4	1A4533	86		
NH_G	200	PS	122	TCFH	4	1A4534	86		
NH_G-690	200	PSU1	92	TDC10	34	1A5018	85		
NH_M	200	R11C	195	TDC11	35	1A5600	87		
NITD	196	R25030	47, 48, 49	TDC180	33	1A5601	85		
NNB	203	R25060	47, 48, 49	TDC600	33	1A5602	85		
NNB-R	203	R25100	47, 48, 49	TL	26	1BS	147		
NNC	203	R25200	47, 48, 49	TP158HC	180	24 Type	187		
No. 1	2004	R25400	47, 48, 49	TP15900-4	178	2499	83		

Bussmann®

Worldwide Circuit Protection Solutions

HEADQUARTERS

Cooper Industries
Bussmann Division
P. O. Box 14460
St. Louis, Missouri 63178-4460, USA
Telephone: 636 394 2877
Fax: 800 544 2570
International: 636 527 1413
Email: fusebox@buss.com

COOPER BUSSMANN CHICAGO

175 Hansen Court
Wood Dale, IL 60191
Telephone: 630 422 2400
Fax: 630 422 2500

EUROPEAN HEADQUARTERS

Cooper (UK) Ltd.
Bussmann Division
Burton-on-the-Wolds
Leicestershire LE12 5th, England
Telephone: 44 1509 882737
Fax: 44 1509 882786
Email: info@bussmann.co.uk

BUSSMANN ASIA-PACIFIC

1 Jalan Kilang Timor
#06-01 Pacific Tech Centre
Singapore 159303
Republic of Singapore
Telephone: 65 278 6151
Fax: 65 278 3151
Email: bussmann@bussasiapac.com.sg

BUSSMANN AUSTRALIA

Block X
391 Park Road
PO Box 257
Regents Park, Sydney
NSW 2143, Australia
Telephone: 61 2 9743 8333
Fax: 61 2 9743 8070

BUSSMANN BRASIL

Bussmann do Brasil Ltda.
Rodovia Santos Dumont, Km 23
Cruz das Almas
Itu - Sao Paulo- 13 300-000
Brasil
Telephone: 55 11 7824 1856
Fax: 55 11 7824 1721

BUSSMANN DENMARK

5 Literbuen
DK-2740 Skovlunde
Copenhagen, Denmark
Telephone: 45 4485 0900
Fax: 45 4485 0901
Email: bussmann@bussmann.dk

BUSSMANN INDIA

2nd floor, Unit #5
White House
23-29, St. Marks Road
Bangalore — 560 001
India
Telephone: 91 80 227 0893
Fax: 91 80 224 0124

BUSSMANN MEXICO

Arrow-Hart, S.A. de C.V.
Poniente 148, No. 933
02300 Mexico, D.F. Mexico
Telephone: 52 5 587 0211
Fax: 52 5 567 4049

COOPER ELECTRONIC TECHNOLOGIES, INC.

6000 Park of Commerce Blvd
Boca Raton, FL 33487
Tel: 561 241 7876
Fax: 561 241 9339

ENBRAY CONTACTORS

Cooper (UK) Limited
Unit 5C, Clay Flatts
Industrial Estate
Workington, Cumbria
CA14 3YD
United Kingdom
Tel : +44 0 1900 870088
Fax : +44 0 1900 870099



COOPER Bussmann

COOPER BUSSMANN • P.O. BOX 14460 • ST. LOUIS, MO 63178-4460 • (636) 394-2877
World Wide Web: www.bussmann.com

CUBEFuse™

The World's First "Finger-Safe" Industrial Fuse.

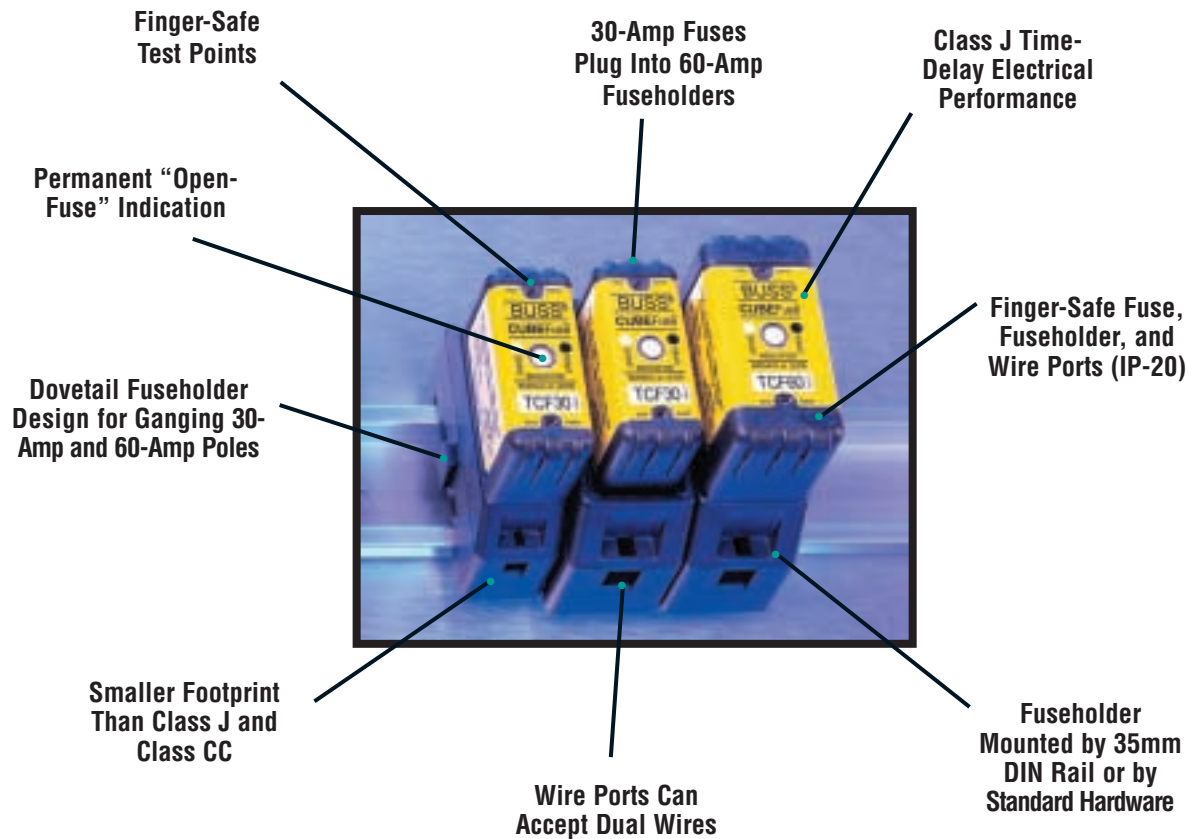

COOPER Bussmann

©2002, Cooper Bussmann, Inc. • St. Louis, MO 63178 • 636-394-2877

www.bussmann.com
www.cubefuse.com

REORDER #1007

10-02-40M