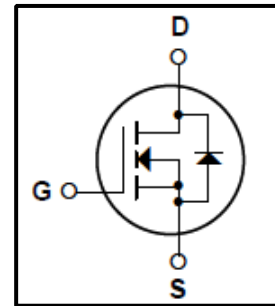
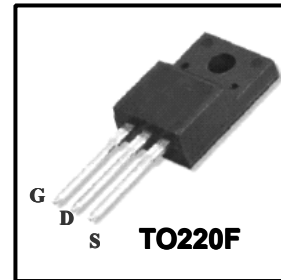

Silicon N-Channel MOSFET
Features

- 12A, 600V, $R_{DS(on)}$ (Max 0.65 Ω)@ $V_{GS}=10V$
- Ultra-low Gate Charge(Typical 39nC)
- Fast Switching Capability
- 100%Avalanche Tested
- Isolation Voltage ($V_{ISO} = 4000V$ AC)
- Maximum Junction Temperature Range(150 $^{\circ}C$)

General Description

This Power MOSFET is produced using Winsemi's advanced planar stripe, VDMOS technology. This latest technology has been especially designed to minimize on-state resistance, have a high rugged avalanche characteristics. This devices is specially well suited for high efficiency switch model power supplies, power factor correction and half bridge and full bridge resonant topology line a Electronic lamp ballast.

Absolute Maximum Ratings

Symbol	Parameter	Value	Units
V_{DSS}	Drain Source Voltage	600	V
I_D	Continuous Drain Current(@ $T_c=25^{\circ}C$)	12*	A
	Continuous Drain Current(@ $T_c=100^{\circ}C$)	7.6*	A
I_{DM}	Drain Current Pulsed (Note1)	48*	A
V_{GS}	Gate to Source Voltage	± 30	V
E_{AS}	Single Pulsed Avalanche Energy (Note 2)	880	mJ
E_{AR}	Repetitive Avalanche Energy (Note 1)	25	mJ
dv/dt	Peak Diode Recovery dv/dt (Note 3)	4.5	V/ns
P_D	Total Power Dissipation(@ $T_c=25^{\circ}C$)	51	W
	Derating Factor above 25 $^{\circ}C$	0.41	W/ $^{\circ}C$
T_J, T_{stg}	Junction and Storage Temperature	-55~150	$^{\circ}C$
T_L	Maximum lead Temperature for soldering purposes	300	$^{\circ}C$

*Drain current limited by maximum junction temperature

Thermal Characteristics

Symbol	Parameter	Value			Units
		Min	Typ	Max	
R_{QJC}	Thermal Resistance, Junction-to-Case	-	-	2.45	$^{\circ}C/W$
R_{QCS}	Thermal Resistance, Case to Sink	-	0.5	-	$^{\circ}C/W$
R_{QJA}	Thermal Resistance, Junction-to-Ambient	-	-	62.5	$^{\circ}C/W$

Electrical Characteristics (Tc = 25°C)

Characteristics		Symbol	Test Condition	Min	Type	Max	Unit
Gate leakage current		I _{GSS}	V _{GS} = ±30 V, V _{DS} = 0 V	-	-	±100	nA
Gate-source breakdown voltage		V _{(BR)GSS}	I _G = ±10 μA, V _{DS} = 0 V	±30	-	-	V
Drain cut-off current		I _{DSS}	V _{DS} = 600 V, V _{GS} = 0 V	-	-	1	μA
Drain-source breakdown voltage		V _{(BR)DSS}	I _D = 250 μA, V _{GS} = 0 V	600	-	-	V
Break Voltage Temperature Coefficient		$\frac{\Delta BV_{DSS}}{\Delta T_J}$	I _D =250μA, Referenced to 25°C	-	0.5	-	V/°C
Gate threshold voltage		V _{GS(th)}	V _{DS} = 10 V, I _D =250 μA	3	-	4.5	V
Drain-source ON resistance		R _{DS(ON)}	V _{GS} = 10 V, I _D =6.0A	-	-	0.65	Ω
Forward Transconductance		g _{fs}	V _{DS} = 50 V, I _D =6.0A	-	15	-	S
Input capacitance		C _{iss}	V _{DS} = 25 V,	-	1790	2355	pF
Reverse transfer capacitance		C _{rss}	V _{GS} = 0 V,	-	175	232	
Output capacitance		C _{oss}	f = 1 MHz	-	23	31	
Switching time	Turn-on Rise time	t _r	V _{DD} =300 V,	-	133	175	ns
	Turn-on Delay time	t _{on}	I _D =12 A	-	80	100	
	Turn-off Fall time	t _f	R _G =9.1 Ω	-	100	160	
	Turn-off Delay time	t _{off}	R _D =31 Ω (Note4,5)	-	233	310	
Total gate charge (gate-source plus gate-drain)		Q _g	V _{DD} = 400 V,	-	39	52	nC
Gate-source charge		Q _{gs}	V _{GS} = 10 V,	-	8.5	-	
Gate-drain ("miller") Charge		Q _{gd}	I _D =1 A (Note4,5)	-	19	-	

Source-Drain Ratings and Characteristics (Ta = 25°C)

Characteristics		Symbol	Test Condition	Min	Type	Max	Unit
Continuous drain reverse current		I _{DR}	-	-	-	12	A
Pulse drain reverse current		I _{DRP}	-	-	-	48	A
Forward voltage (diode)		V _{DSF}	I _{DR} = 12 A, V _{GS} = 0 V	-	-	1.4	V
Reverse recovery time		t _{rr}	I _{DR} = 12 A, V _{GS} = 0 V,	-	418	-	ns
Reverse recovery charge		Q _{rr}	dI _{DR} / dt = 100 A / μs	-	4.85	-	μC

Note 1.Repeativity rating :pulse width limited by junction temperature

2.L=11.2mH,I_{AS}=12A,V_{DD}=50V,R_G=25Ω,Starting T_J=25°C

3.I_{SD}≤12A,di/dt≤300A/us, V_{DD}<BV_{DSS},STARTING T_J=25°C

4.Pulse Test: Pulse Width≤300us,Duty Cycle≤2%

5.Essentially independent of operating temperature.

This transistor is an electrostatic sensitive device

Please handle with caution

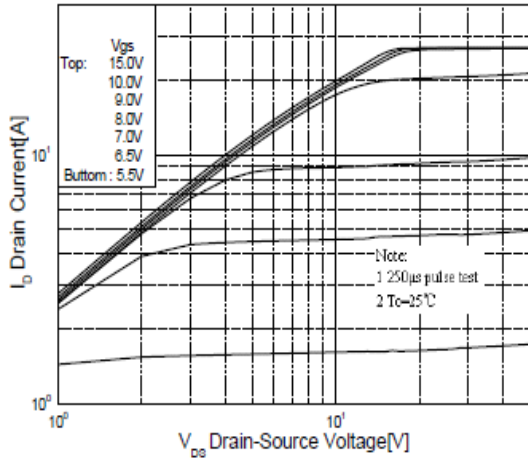

Fig. 1 On-State Characteristics

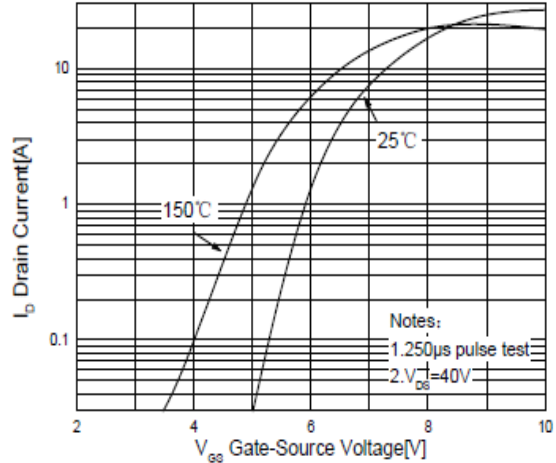

Fig. 2 Transfer Characteristics

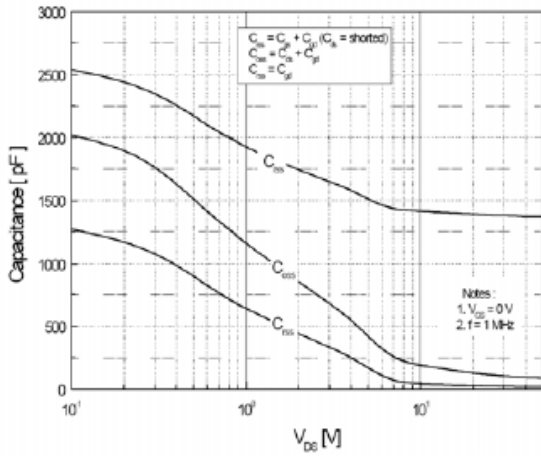

Fig. 3 Capacitance Variation vs. Drain Voltage

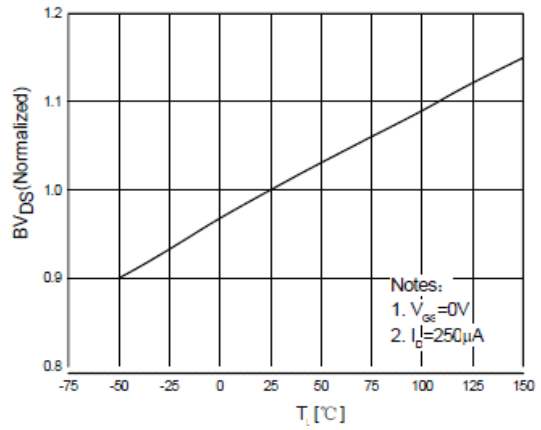

Fig. 4 Breakdown Voltage Variation vs. Temperature

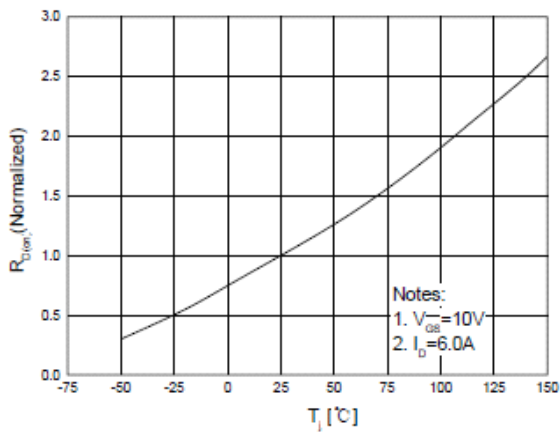

Fig. 5 On-Resistance Variation vs. Junction Temperature

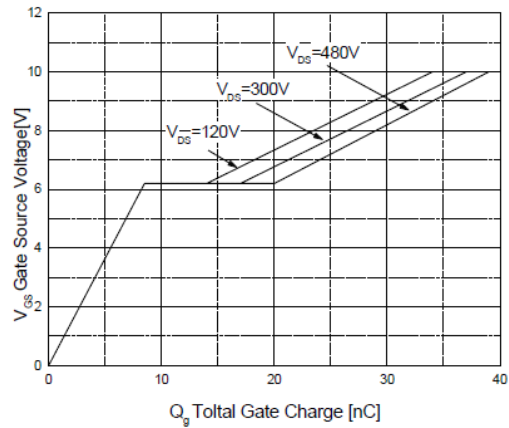

Fig. 6 Gate Charge Characteristics

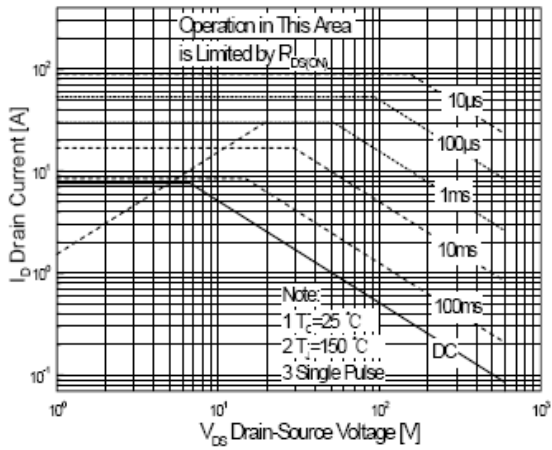

Fig.7 Maximum Safe Operation Area

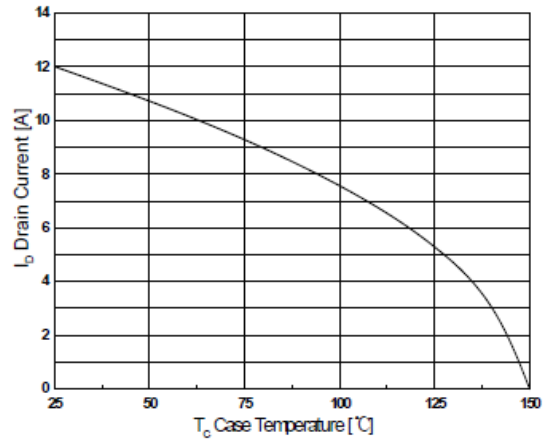

Fig.8 Maximum Drain Current vs Case Temperature

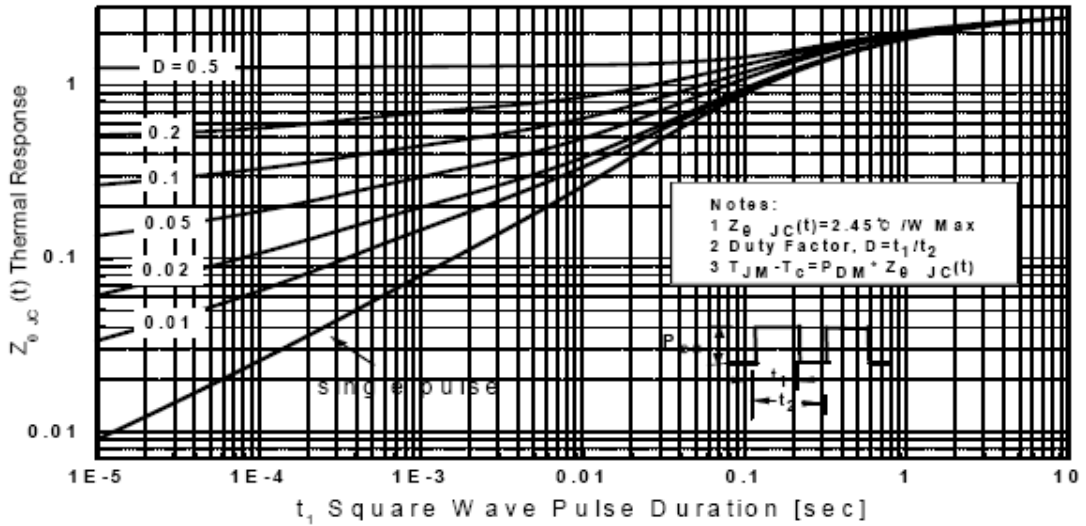

Fig.9 Transient Thermal Response Curve

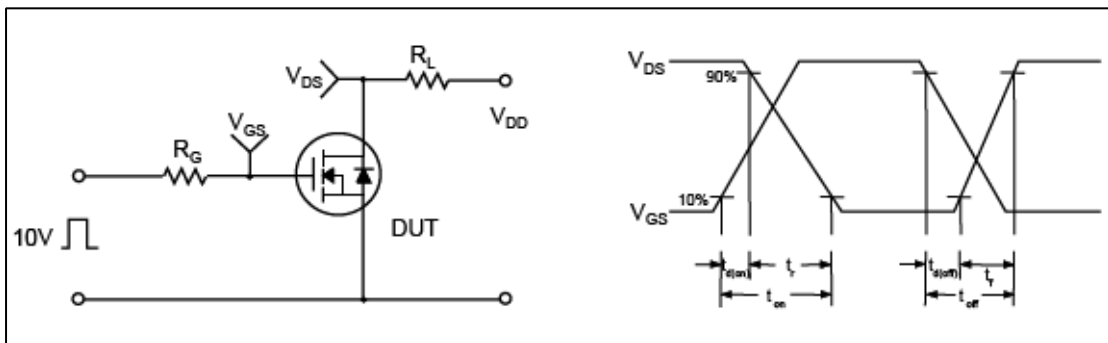
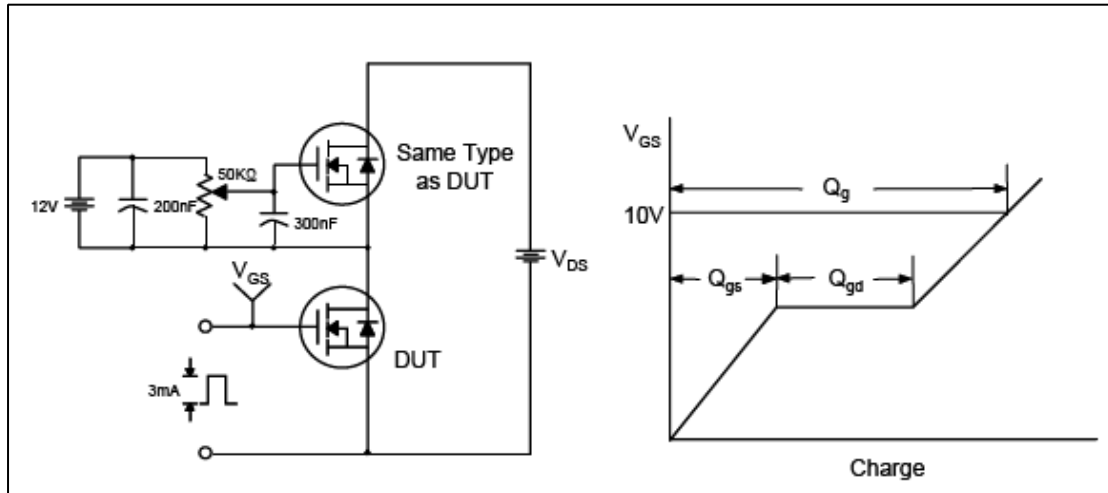

Fig.11 Resistive Switching Test Circuit & Waveform

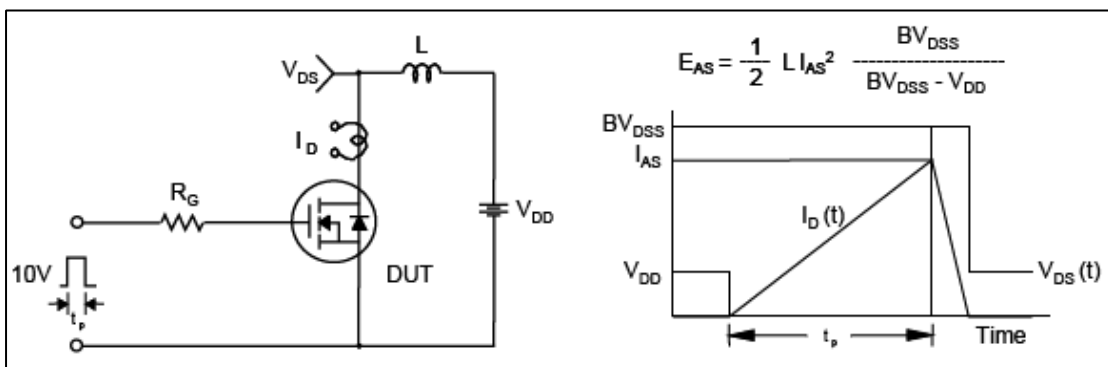

Fig.12 Unclamped Inductive Switching Test Circuit & Waveform

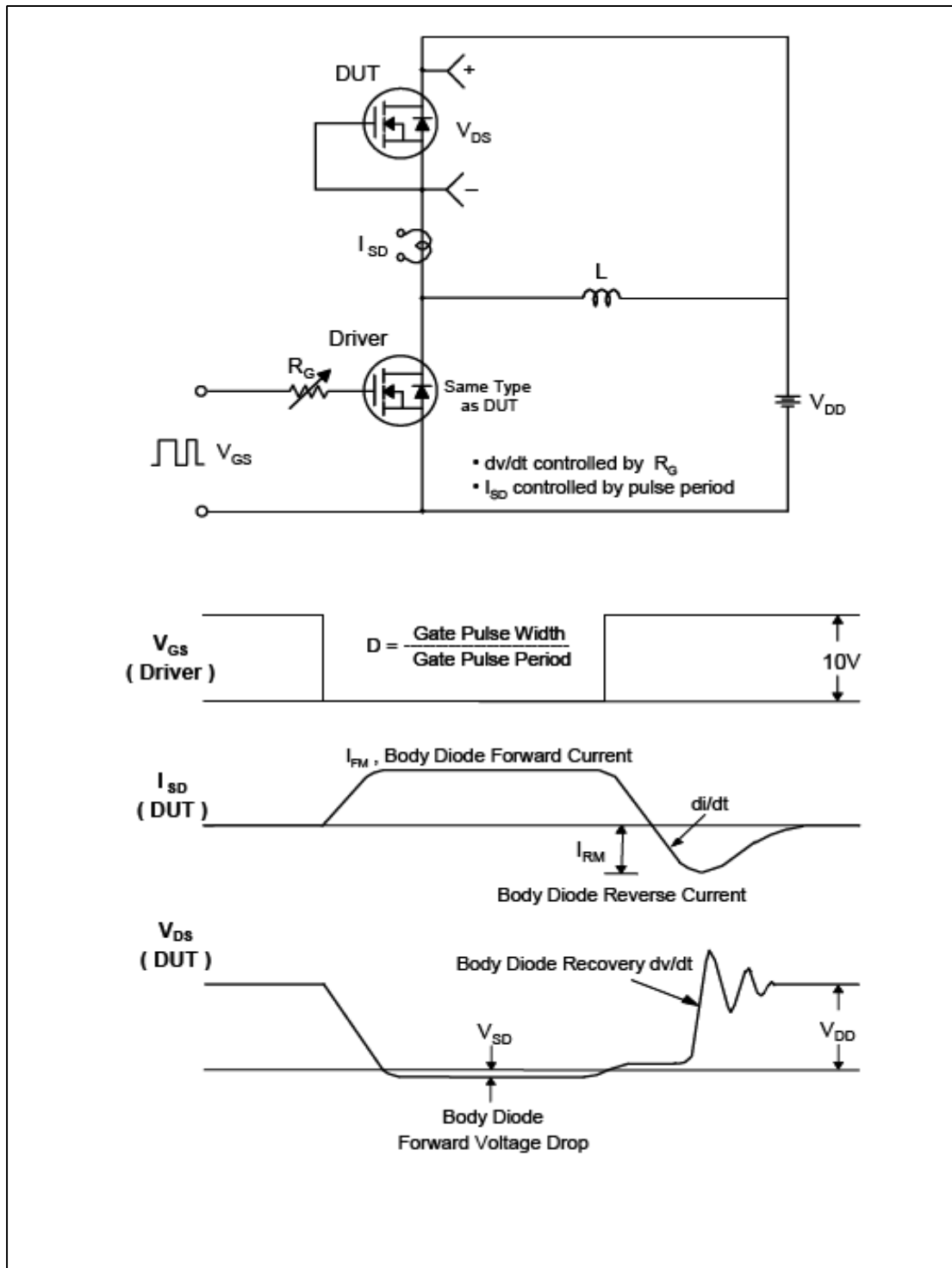

Fig.13 Peak Diode Recovery dv/dt Test Circuit & Waveform

TO-220F Package Dimension

