

Features

- Single power supply can operate at 2.4 V through 6.0 V.
- Current output can drive 8 ohm speaker with a transistor.
- The voice content can be separated to 32 sections.
- Duration of each section can be different and is multiples of 100 h.
- Duration of sections with appended memory-less mute is up to 21.8 seconds (20000h).
- 3 straight trigger pins are provided TGA, TGB, TGC. Each cross can access a sentence.
- 4 x 4 matrix trigger crosses are provided by RW1-4, K1-4. Each cross can access a sentence.
- Each sentence is composed of one or more sections.
- Lower key priority is provided for straight inputs and matrix cross inputs.
- Last key priority is provided for straight inputs.
- First key priority is provided for 4x4 crosses.
- Up to 512 table entries for all 32 sentences.
- Auto ramp up / ramp down & sleep functions are built in.
- INT(interrupt) function is provided.
- OKY function is provided optionally chipwise.
- Play all OKY is provided optionally chipwise.
- Random Play OKY is provided optionally chipwise.
- Playnext OKY is provided optionally chipwise.
- Continuous S.W.A.I. OKY is provided optionally chipwise.
- Home S.W.A.I. OKY is provided optionally chipwise.
- 5 output pins are provided.
- 20 ms debounce is provided.
- Sink LED is provided.
- Off LED when Playing audio is provided optionally entrywise.
- Slow Ring flash LED when playing audio is provided optionally entrywise.
- Dynamic flash LED when playing audio is provided optionally entrywise.
- Slow fix flash LED when playing audio is provided optionally entrywise.
- On LED when playing audio is provided optionally entrywise.
- High busy when playing audio is provided optionally entrywise.
- Low busy when playing audio is provided optionally entrywise.
- DC high (when playing audio and lasts to next trigger) is provided optionally entrywise.
- DC low(when playing audio and lasts to next trigger) is provided optionally entrywise.
- Low Stop after playing audio is provided optionally entrywise.
- High Stop after playing audio is provided optionally entrywise.
- OKY's sentences could be different from those from TGS'.
- 8 loudness levels are provided entrywise.
- 8 different pitches are provided entrywise.
- Edge trigger is provided optionally triggerwise.
- Level trigger is provided optionally triggerwise.
- Holdable output by TG is provided optionally triggerwise.
- Retriggerable TG by itself is provided optionally triggerwise.
- Retriggerable TG by others is provided optionally triggerwise.
- High trigger is provided optionally triggerwise.
- Low trigger is provided optionally triggerwise.

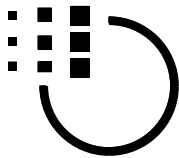

Description

The MSSnn07 is a single-chip CMOS VLSI ROM that can memorize voice data up to nn seconds using MOSEL qualified coding method (5-bit MPCM) at 6.00 KHz in 32 sections with arbitrary length. Both the volume and pitch can be masked and different for each entry each sentence. 5 versatile outputs are available through programmable logic array. With minimum external components, this chip can be applied to various application. Customer voice data will be edited and programmed into ROM by changing one layer of mask during fabrication.

Mask Options Overall

- either Large or Small cout driving current
- either large (1-32) or small loop (17-32) on OKY cycle
- either continuously or homely PlayNext function
- among PlayAll, PlayNext or Random for OKY function
- either direct TGA or OKY for TGA pin
- either direct TGC or INTP for TGC pin
- either sink or drive for LED output (fixed at sink)

Mask Options (on straight triggers & OKY)

- either Level or Edge trigger type
- either Holdable or not
- either retriggerable or not
- either quick or normal debounce time
- either high or low active
- either internal pulling or not (fixed at pulling)
- either internal latch or not (fixed at latch)
- either power on play or not (fixed at no power on play)

Development Tools

- M9026 emulaton board is provided
- M9026 pack.exe program is provided
- Computer format (Lotus 1-2-3 work sheet) request forms A1-A8, F, H are provided
- COB P28 is provided
- COB M9226 is provided

Voice Storage Reference

Device	Capacity	Duration at 6KHz S.R.	Section	Entry / Sentence	Word with mute behide
MSS1807	1A600h	18.01 seconds	32	512/32	20000h
MSS1507	16000h	15.01 seconds	32	512/32	20000h
MSS1207	11A00h	12.03 seconds	32	512/32	20000h
MSS0907	D800h	9.21 seconds	32	512/32	20000h
MSS0607	9000h	6.14 seconds	32	512/32	20000h
MSS0307	5100h	3.45 seconds	32	512/32	20000h

Specifications subject to change without notice, contact your sales representatives for the most recent information.

Mask Options (entrywise)

- among 8 pitches for each entry
 - among 8 loudness for each entry
 - among 15 features for OS pin for each entry
 - among 15 features for OW pin for each entry
 - among 15 features for OX pin for each entry
 - among 15 features for OY pin for each entry
 - among 15 features for OZ pin for each entry
- among these 15 options for every entry every OUT pin:
 (A) high stop (B) low stop (C) high busy (D) low busy (E) DC high (F) DC low (G) LED dynamic 17/31 (H) LED dynamic 23/31 (J) LED dynamic 27/31 (N) LED fixed flash slow (R) LED ring flash slow (2) LED fix flash slow inverse (4) LED ring flash slow inverse (7) LED on (8) LED off.

Mask Options (on matrix K input)

- either Level or Edge trigger type
- either Holdable or not
- either retriggerable or not
- either quick or normal debounce time (fixed at normal, =20 ms)

Mask Options (for INT)

- either quick or normal debounce time
- either high or low active

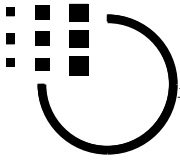

Block Diagram

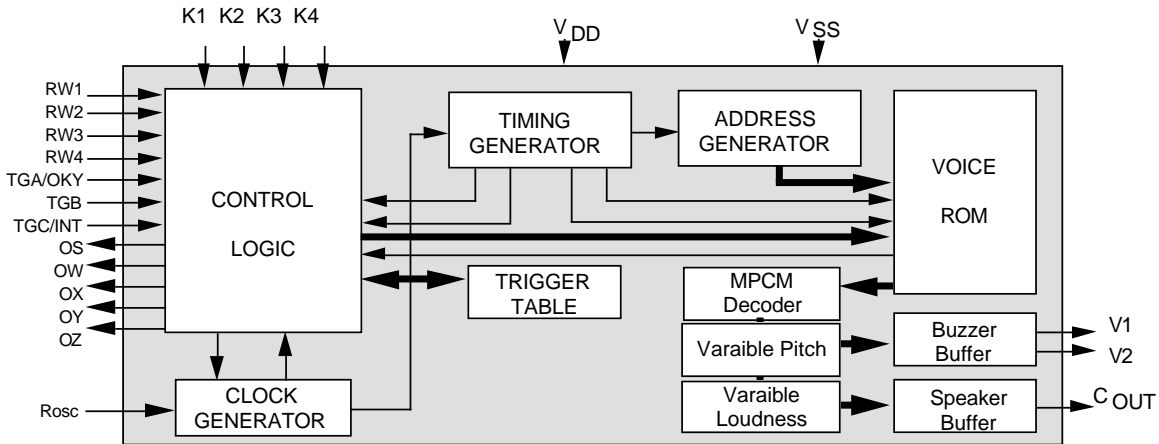

Pad Description

Pad #	Signals	I/O	Function
1	V2	1 O	Voltage output 1, to drive buzzer
2	V1	1 O	Voltage output 2, to drive buzzer
3	Vss	1 Power	Ground
4	Rosc	1 I	Rosc
5	TGC/INTP	1 I	Trigger C or Interrupt input, mask optional
6	TGB	1 I	Trigger B input
7	TGA/OKY	1 I	Trigger A or one-key input, mask optional
8	Vdd	1 Power	Positive power supply
9	NC	1 -	No connection
10	K4	1 I	Matrix trigger column input 4
11	K3	1 I	Matrix trigger column input 3
12	K2	1 I	Matrix trigger column input 2
13	K1	1 I	Matrix trigger column input 1
14	RW1	1 -	Matrix trigger row input 1, feed signal to K pin(s) when contact
15	RW2	1 -	Matrix trigger row input 2, feed signal to K pin(s) when contact
16	RW3	1 -	Matrix trigger row input 3, feed signal to K pin(s) when contact
17	RW4	1 -	Matrix trigger row input 4, feed signal to K pin(s) when contact
18	OZ	1 O	Output signal Z
19	OY	1 O	Output signal Y
20	OX	1 O	Output signal X
21	Cout	1 O	Current Output, to drive speaker through transistor
22	OW	1 O	Output signal W
23	OS	1 O	Output signal S

Specifications subject to change without notice, contact your sales representatives for the most recent information.

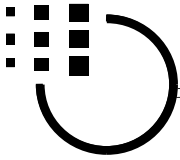

Signals

Cout

Cout is tristate during standby.

Cout has zero current output when sound data is zero. Cout has full current output when sound data is the highest. Cout has half of full current output when sound is silence at middle data value. Cout has half of full current output when playing sound at appended memory-less mute.

Ico of Cout behaves two different characteristics shown as curve 2 and curve 3. Curve 3 is recommended when operating at 2.5V through 5.0V. Curve 2 is recommended when operating at 5.0V through 6.0V.

The bypass Cout Resistor (named R2) is used to bypass the audio output current from Cout. This bypassing extra current to ground gives a way to prevent the saturation of audio waveform amplified by transistor. This Resistance of R2 is 470 ohm typically. It always is not very small. Or user can let it open if the transistor has a fair beta value.

Due to Cout depends on Vdd bias very much, this R2 resistance needs be very carefully selected when user supplies the voltage potential source in poor flatness or in poor drive capability.

What the poor source means either its potential drops as the load varies or its potential drops as its capacity exhausted.

A transistor with beta value 150 is sufficient for typical applications. Larger beta value get larger sound but may have the amplified waveform saturated.

8 ohm speaker is recommended. The speaker characteristics and housing impacts the loudness very much.

When user is using variable loudness, user must carefully calculate the bypass resistance R2 and transistor's beta value due to that the current from Cout may vary very much due to user's specified loudness variance.

V1, V2

They are tristate during standby state.

These two pins can drive buzzer directly. The piezo buzzer used should have its resonant frequency at the center of your sound frequency domain or you are unable to play your sound good by this buzzer.

For instance, you have your sound spans over frequency from 100 Hz through 1 KHz. A buzzer with resonant frequency at 300 Hz will play this sound good. A buzzer with resonant frequency at 1 KHz will distort the sound very much because that most of the energy of the playback sound is unable to be played by this buzzer.

OS, OW, OX, OY, OZ

There are 5 output pins provided. Each pin can perform its performance independent on other four pins.

An output pin can be masked to perform one out of 15 features per entry. But it has restriction : a pin can perform up to 8 features only at a mask code. These 8 features should not have too far relationships.

Contact our sales representatives if you want to use diverse output performance.

Rosc

This is a pin to provide bias to activate built in VCO circuit. A 600 K ohm resistor serial from Vdd to this pin (named R1) can play the audio output at 6 KHz sample rate at pitch option 4. Larger Resistance provided at this location plays lower sample rate. A 240 Kohm resistor plays 15 KHz sample rate at same condition.

The Vdd bias has very less impact on the relationship between Rosc and sample rate. To play 6 KHz, user needs 600 K ohm at 3 Vdd and 590 K ohm at 6 Vdd. To play 15 KHz, user needs 240 K ohm at 3 Vdd and 230 K ohm at 6 Vdd.

K1, K2, K3, K4

These four pins have two ways to perform.

To cooperate with RW1, RW2, RW3 and RW4, they form a 4 x 4 matrix in 16 cross points. The touch of a cross point will pass signal from a RW pin to this K pin and activates a trigger signal to play respectively sentence.

To not cooperate with RWn, these K pins can act as straight trigger and work standalone. A Vdd provided to Kn can play sentence.

RW1, RW2, RW3, RW4

These four pins can cooperate with Kn pins to form a 4 x 4 matrix in 16 cross points. The touch of a cross point passes signal from this RW pin to K pin(s) and activates a trigger signal to play corresponding sentence.

The result to be played is not guaranteed when operating at below three conditions:(1) All four RWn signal pins tied together, (2) Any three RWn signal pins connected together, (3) Any two RWn signal pins connected together. The result may even be no sound played.

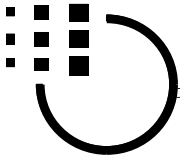

Terms

Retriggerable TG

Retriggerable TGm means the sentence addressed by TGm could be retriggered by other TGs.

See Timing diagrams I & III. Of course, it can be retriggered by itself. See Timing diagrams I.

Ramp up

When a sentence starts playing from silence, the audio output (either Cout or V1, V2) starts from zero current and ramps up to the half scale of full audio output in 128 steps. These 128 steps' gaps are uniform. After these 128 steps accomplished the sentence sound data begins.

As this is hardware implement, the first data byte of a sound file is asked to be center value. for 8 bit PCM data file, the center value is 80h.

Herein zero output does not mean zero potential, neither ground.

Ramp down

Whenever a sentence is played and finished, the audio outputs (either Cout or V1, V2) try going from last data down to zero.

There is an interval provided in width t PL. Without redundant ramp down and up within this interval, the audio output keeps at center value of full audio signal. This is to keep the audio output sounds continued if there comes a latter sentence. This interval starts from the last data pixel to the ramp down starts.

Because the output is kept at center value of full audio signal, the last data pixel of a sound file is recommended as center value. For 8 bit PCM data file, the center value is 80h.

After this t PL interval finished and there comes no new comer sentence, the audio output gradually reduces in 128 steps from the center value of full audio signal down to zero output.

Herein zero output does not mean zero potential, neither ground.

Trigger

A trigger mentioned in this data sheet does mean either a certain pin or an activated input signal. It could be:

- (1) a high signal to straight input
- (2) a low signal to straight input
- (3) a cross touch of a pin K and a pin RW.

Power on play

This function is not provided even have appropriate wiring.

Active high and active low

An input pin can be masked as either active high or active low.

This active-high pin is internal pull low and no latch.

This active-low pin is internal pull high and no latch.

Small Loop & Large Loop

This is a function belongs to OKY. OKY plays many sentences, up to 32. User can play 1st sentence through 32nd sentence if user selects "large loop". At this time the sentence 1st, 2nd, 3rd and 4th may be triggered by TGs.

User will play 16 sentences, from 17th through 32nd sentence, when user selects "small loop". User may have less sentences triggered by OKY at this selection. But user definitely can prevent those OKY's sentences triggered by TGs.

Cycle Loop

This is a count number ranges 1 through 32 which defines the sentence range OKY will play. This number is user definable and could be equal to or less than sentence defined.

Continuous OKY & Home OKY

This is a function belongs to OKY and determines the play sequence when the first OKY comes after any other trigger addressing. The "continuous" preserves the sequence while the "home"rewinds to the very beginning. This very beginning means either 17th sentence or 1st sentence which is determined by Loop Size - small or large.

You will see a term S.W.A.I. in this data sheet, it means sequence when after interrupt by other trigger addressing.

Random Play OKY

A trigger at OKY will play a sentence randomly out from specified sentence group.

But not every mask option combination provides random play. It is provided only when masked as edge and unhold. It is regardless retrigger or not. Herein sentence group is determined by cycle loop and small / large loop.

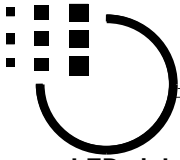
**LED sink and drive**

The LED lamp could be turned on at output pin by sink connection. No drive is provided.

Fix Flash slow LED

Fix flash slow means this pin turns LED lamp on for t ONL and then turns it off for t ONL alternately. And it turns on LED lamp right at the ramp up starts. It turns off LED lamp right after sound ends. Even within t PL interval, before ramp down starts, the LED lamp is turned off.

Fix Flash LED slow & inverse

This is similar to "Fix flash slow LED" but inversed within the sound activated period. The inverse means whenever the LED pin turns on the "inverse pin" turns off LED.

By this feature, user can specify two LEDs, or more, turns on and off alternately within the sound activated period.

Dynamic Flash LED

The LED turns on whenever the sound amplitude is over a certain threshold potential. This threshold can be specified per pin per entry.

There are three thresholds: 17/31, 23/31 and 27/31.

Five output pins could have identical thresholds or not.

An output pin specified to 17/31 means it could be turned on whenever the sound plays at an amplitude over 54% of full scale output. An output pin specified to 17/31 is easier to turn on than an output pin specified to 23/31.

Ring Flash 5 LEDs slow

User can specify 5 LEDs ring at slow speed. It means LEDS is turned on for t ONL and then turns off for 4 x t ONL. And cycles. The LEDW turns on right after LEDS turns off.

LEDW is turned on for t ONL and then turns off for 4 x t ONL. And cycles. The LEDX turns on right after LEDW turns off.

LEDX is turned on for t ONL and then turns off for 4 x t ONL. And cycles. The LEDY turns on right after LEDX turns off.

LEDY is turned on for t ONL and then turns off for 4 x t ONL. And cycles. The LEDZ turns on right after LEDY turns off.

LEDZ is turned on for t ONL and then turns off for 4 x t ONL. And cycles.

This 340 ms t ONL equals 1 over 2.93. Of course, this is valid within sound activated period.

This t ONL is sample rate dependent.

Ring Flash 4 LEDs slow

User can specify 4 LEDs ring at slow speed. It means LEDS is turned on for t ONL and then turns off for 4 x t ONL. And cycles. The LEDW turns on right after LEDS turns off.

LEDW is turned on for t ONL and then turns off for 3 x t ONL. And cycles. The LEDX turns on right after LEDW turns off.

LEDX is turned on for t ONL and then turns off for 3 x t ONL. And cycles. The LEDY turns on right after LEDX turns off.

LEDY is turned on for t ONL and then turns off for 3 x t ONL. And cycles.

This 340 ms t ONL equals 1 over 2.93. Of course, this is valid within sound activated period.

This t ONL is sample rate dependent.

If user needs 4 LED lamps to perform ring flash. These 4 pins are only candidates.

Other 4 - lamp combinations are not guaranteed.

Ring Flash 3 LEDs slow

User can specify 3 LEDs ring at slow speed. It means LEDS is turned on for t ONL and then turns off for 2 x t ONL. And cycles. The LEDW turns on right after LEDS turns off.

LEDW is turned on for t ONL and then turns off for 2 x t ONL. And cycles. The LEDX turns on right after LEDW turns off.

LEDX is turned on for t ONL and then turns off for 2 x t ONL. And cycles.

This 340 ms t ONL equals 1 over 2.93. Of course, this is valid within sound activated period.

This t ONL is sample rate dependent.

If user needs 3 LED lamps to perform ring flash. These 3 pins are only candidates.

Other 3 - lamp combinations are not guaranteed.

Ring Flash 3 LEDs slow & inverse

User can specify 3 LEDs ring at slow & inverse. It means

LEDS is turned off for t ONL and then turns on for 2 x t ONL. And cycles. The LEDW turns off right after LEDS turns on.

LEDW is turned off for t ONL and then turns on for 2 x t ONL. And cycles. The LEDX turns off right after LEDW turns on.

LEDX is turned off for t ONL and then turns on for 2 x t ONL. And cycles.

This 340 ms t ONL equals 1 over 2.93. Of course, this is valid within sound activated period.

This t ONL is sample rate dependent.

If user needs 3 LED lamps to perform ring flash. These 3 pins are only candidates.

Other 3 - lamp combinations are not guaranteed.

Ring Flash 4 LEDs slow & inverse

User can specify 4 LEDs ring at slow & inverse.

It means LEDS is turned off for t ONL and then turns on for 3 x t ONL. And cycles. The LEDW turns off right after LEDS turns on.

LEDW is turned off for t ONL and then turns on for 3 x t ONL. And cycles. The LEDX turns off right after LEDW turns on.

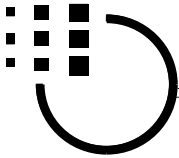

LEDX is turned off for t ONL and then turns on for 2 x t ONL. And cycles. The LEDY turns off right after LEDX turns on.

LEDY is turned off for t ONL and then turns on for 2 x t ONL. And cycles.

This 340 ms t ONL equals 1 over 2.93. Of course, this is valid within sound activated period.

This t ONL is sample rate dependent.

If user needs 4 LED lamps to perform ring flash.

These 4 pins are only candidates.

Other 4 - lamps combinations are not guaranteed.

Ring Flash 5 LEDs slow & inverse

User can specify 5 LEDs ring at slow & inverse.

It means

LEDS is turned off for t ONL and then turns on for 4 x t ONL. And cycles. The LEDW turns off right after LEDS turns on.

LEDW is turned off for t ONL and then turns on for 4 x t ONL. And cycles. The LEDX turns off right after LEDW turns on.

LEDX is turned off for t ONL and then turns on for 4 x t ONL. And cycles. The LEDY turns off right after LEDX turns on.

LEDY is turned off for t ONL and then turns on for 4 x t ONL. And cycles. The LEDZ turns off right after LEDY turns on.

LEDZ is turned off for t ONL and then turns on for 4 x t ONL. And cycles.

This 340 ms t ONL equals 1 over 2.93. Of course, this is valid within sound activated period.

This t ONL is sample rate dependent.

Initial high & Initial low

This is a function belongs to OUTs. It defines the state only from power on to the first audio activated. It is effective for all 15 features.

"Initial low" means user want this OUT pin is put to low whenever this chip is power on. "Initial high" means vice versa.

Initial high is good for LED because that high will forbid the LED to be turned on, user want not keep the LED light even user don't use very long time since user power on the chip. So, we suggest user to define "initial high" whenever LED is chosen for that OUT pin. But it is not absolutely right. User may on purpose turn it on once user likes it.

Initial low is good for Busy because that low will have every Busy starts from zero on whole time line. So, user are suggested to define "initial low" whenever Busy is chosen for that OUT pin.

But it is not absolutely right. User may on purpose have a high to do whatever user want, to turn a motor running this way or tell a situation since power on, etc.

The similar situation for DC high or low. The similar situation for Stop signal.

DC 0 & DC 1

DC 0 is read as D.C. zero and is quick form of DC low.

DC 1 is read as D.C. one and is quick form of DC high.

This is a function belongs to OUTs. User may be confused it with Busy. It is similar to Busy signal but it is not only valid during audio is being played, like Busy, but also valid after the audio has been played. Its response lasts until next audio entry is activated.

DC0 means zero potential (Vss) while the DC1 means the Vdd.

Output pins at Cout plays mute

Mute has two types in MVI's Snn07 voice chip. Both these two types of mute are treat as sound for considering the output. The Stop is generated after every mute. Busy is valid during every mute.

LED works at every mute.

Be careful that t PL interval does not count in mute.

Stop Pulse

Stop pulse is genrated right at the sound ends and lasts for 40 ms typically. The mask options provide either high stop pulse or low stop pulse. Stop pulse width is determined on the sample rate as well as the pitch of that playing entry when stop pulse occurs.

This 40 ms stop pulse is sufficiently wide to activate TGA (or TGB or TGC) by feed back wiring.

Sample Rate

There are some parameters depend on sample rate. They are debounce time, ramp up time, ramp down time, plain time, LED Ring frequency, LED fix flash frequency and Stop pulse width. The numbers mentioned in this data sheet are based on 6 KHz sample rate if not specified. Higher SR has LED flashes quicker. Higher SR makes Stop pulse shorter. Higher SR let the debounce time shorter. Higher SR makes the ramp up time quicker. Higher SR makes the ramp down time quicker, too. Higher SR makes shorter plain time.

This chip provides multi-SR function. What it means is that user can digitize two different sounds in different SR but plays them by a common Rosc. For example, user has rocket sound digitized in 9.5 KHz but have rooster digitized at 6 KHz. While manufactured, user just specify different pitch numbers on request form - 4 for rocket and 1 for rooster. The chip could be played those two sounds at a Rosc fit for 6 KHz SR. Because that "pitch 4" at 6 KHz Rosc means 6 KHz playback while "pitch 1" at 6 KHz Rosc meas playback in 1.6 times 6 KHz.

The 600K ohm Rosc playback 6 KHz sample rate typically, but just typical. Smaller Rosc playbacks quicker - Higher pixel rate. MVI provides voice chip with very flat response for playback vs working voltage. Higher working voltage get slower playback but insignificantly.

Lower Key Priority

What's the result when multi triggers are activated simultaneously? Which trigger is acknowledged among these nineteen? Among these sixteen? Among these three? Between these two?

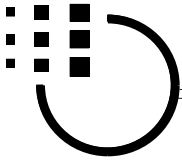

The lower key priority means the trigger with lower index has the priority to be acknowledged and responded when there are several triggers activated simultaneously.

For example: Three triggers are activated simultaneously, RW3K1, RW2K3, RW4K2. The RW3K1 has the priority, sentence 3 will be responded.

For another example: Five triggers are activated simultaneously, RW1K2, RW2K3, TGA/OKY, TGB, TGC. The RW1K2 has the priority, sentence 5 will be responded.

There is a priority reference on page 9/39 and a timing diagram III to illustrate it.

First Key Priority

First key priority is available among 16 matrix triggers. This defines the relationship on time line for two or more triggers overlap. While user activating a trigger, for example RW2K2, and its sound plays, user is unable to activate the other trigger once RW2K2 is kept activated regardless sentence 6 is finished or not. It means first trigger prohibits the acknowledge of later triggers when trigger is kept true.

Last Key Priority

Last key priority is available among three straight keys - TGA, TGB, TGC.

This defines the relationship on time line for two or more triggers overlap. What will it result when a trigger is activated while a trigger is true ahead and kept true ?

While user already activates a trigger, for example TGC, and keeps this TGC true, the later trigger is still able to come in and acknowledged by chip. It means the late trigger is not prohibited by priorer. See timing diagrams III.4,5,6 for reference.

User may be confused it with "retrigger". They are different.

Application Notes

R1

Oscillation Resistor at pin Rosc, see chapter Signals paragraph Rosc as well as DC Characteristics for detail.

R2

Bypss Resistor at pin Cout, see chapter Signals paragraph Cout for detail.

R cds

Maximal contact resistance. Whenever try to activate the input signal pin at matrix triggers, to have the cross point contacted will activate it. However, there may be resistance on the cross point A resistance higher than this R cds will be unable to activate the trigger.

To apply Vdd (or Vss, depends on mask option specified) directly to stand-alone trigger will activate the trigger. However, there may be resistance on the contact point. A resistance higher than R cds will be unable to activate the trigger, either.

To limit current runs through LED lamp

S1207 output pin provides huge drive (or sink) current capability. But the LED lamp may not need so huge current to have a best performance. To serial a resistor along with LED lamp is recommended.

Don't flash LED at Cout Silence

The LED lamp flashes well in whatever options user specified when the sound is playing. Don't flash LED lamp when Cout stays at mute is strongly recommended.

If user insists, please be noted that there is a slight drum stream comes out at speaker. Its frequency is double the frequency of LED flash. Its loudness depends on the Vdd bias, transistor amplification and count of LED lamp flashes. It could be -35 dB (or even lower as -50 dB) lower than the meaningful sound played at the office operation environment and hand-touchable distance.

Key Priority Reference

Conditions	Between Straight Triggers	Between Straight trigger And Matrix trigger		Between Matrix triggers		
		TGm	KiRWj	KhRWi	KiRWj	KiRWm
Priorer	TGm	TGm	KiRWj	KhRWi	KiRWj	KiRWm
Later	TGn	KiRWj	TGm	KhRWj	KjRWj	KjRWn
Priority Result	Last key	Not Guaranteed	Not Guaranteed	First key	First key	First key

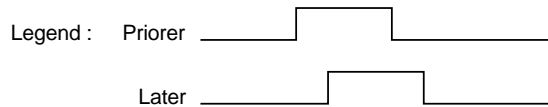

Specifications subject to change without notice, contact your sales representatives for the most recent information.

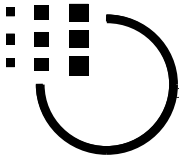

Pitches Reference

Mask	Index	Playback	Playback	Pitcl
111	7	73% x Fosc	Fosc / 1.37	Slowest
110	6	80% x Fosc	Fosc / 1.25	
101	5	88% x Fosc	Fosc / 1.13	
100	4	100% x Fosc		Standard
011	3	115% x Fosc		
010	2	133% x Fosc		
001	1	158% x Fosc		
000	0	198% x Fosc		Fastest

The precision is +/- 10%

Loudness Levels Reference

Mask	Index	I output	Loudness
111	7	100% x Ico	Loudest
110	6	87% x Ico	
101	5	75% x Ico	
100	4	62% x Ico	
011	3	50% x Ico	
010	2	37% x Ico	
001	1	25% x Ico	
000	0	12% x Ico	Least Loud

The precision is +/- 10%

Lower Key Priority Reference

Priority	Trigger	Sentence	Remarks
1	K1RW1	1	Highest
2	K1RW2	2	
3	K1RW3	3	
4	K1RW4	4	
5	K2RW1	5	
6	K2RW2	6	
7	K2RW3	7	
8	K2RW4	8	
9	K3RW1	9	
10	K3RW2	10	
11	K3RW3	11	
12	K3RW4	12	
13	K4RW1	13	
14	K4RW2	14	
15	K4RW3	15	
16	K4RW4	16	
17	TGA/OKY	17	
18	TGB	18	
19	TGC/INT	19	Lowest

Ico Reference Curves

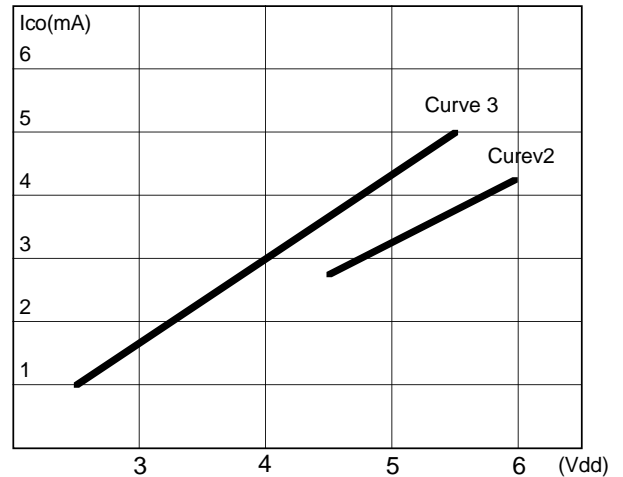

These curves show the typical values. The max. and min. values are not identified.

Absolute Maximum Rating

Symbol	Rating	Unit
VDD ~ VSS	-0.5 ~ +7.0	V
V _{IN}	V _{SS} - 0.3 < V _{IN} < V _{DD} + 0.3	V
V _{OUT}	V _{SS} < V _{OUT} < V _{DD}	V
T (Operating)	-10 ~ +60	°C
T (Storage)	-55 ~ +125	°C

Fosc Characteristics

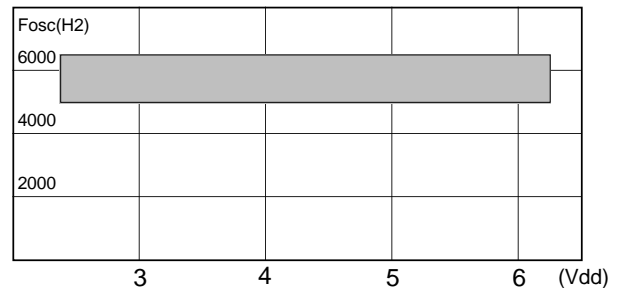

@600 K ohm Rosc & pitch option 4

Specifications subject to change without notice, contact your sales representatives for the most recent information.

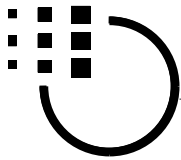

DC Characteristics at 3.0 Vdd

Symbol	Parameter	Valid	Min.	Typ.	Max.	Unit.	Condition
I _{sb}	Stand by I	Vdd			1	uA	i/o open
I _{op}	Operation I	Vdd		75	150	uA	
I _{ihK}	input high I	K1,2,3,4		3	15	uA	
I _{iLK}	input low I	K1,2,3,4		0		uA	
I _{ohR}	output high I	RW1,2,3,4		-10		mA	
I _{oLR}	output low I	RW1,2,3,4		10		mA	
I _{ihT}	input high I	TGA,B,C		3	15	uA	mask:=active high
I _{iLT}	input low I	TGA,B,C		0		uA	mask:=active high
I _{ohr}	output high I	OS,W,X,Y,Z		-10		mA	
I _{oLr}	output low I	OS,W,X,Y,Z		10		mA	
I _{co}	current output	Cout		1.8		mA	half scale, curve Ico 3
V _{co}	Current o/p V	Cout				mV	
R1	Oscillation R	Rosc		600		Kohm	SR=6 KHz
R1	Oscillation R	Rosc		450		Kohm	SR=8 KHz
R1	Oscillation R			240		Kohm	SR=15 KHz
R2	Bypass R					ohm	
R _{cds}	max contact R					Kohm	
d F/F	Frq. stability			+/- 5		%	[F(3.0V)-F(2.7V)]/F(3.0V)
d F/F	Frq. variation			+/- 10		%	lot by lot

DC Characteristics at 4.5 Vdd

Symbol	Parameter	Valid	Min.	Typ.	Max.	Unit.	Condition
I _{sb}	Stand by I	Vdd			1	uA	i/o open
I _{op}	Operation I	Vdd		150	200	uA	
I _{ihK}	input high I	K1,2,3,4		10	20	uA	
I _{iLK}	input low I	K1,2,3,4		0		uA	
I _{ohR}	output high I	RW1,2,3,4		-20		mA	
I _{oLR}	output low I	RW1,2,3,4		20		mA	
I _{ihT}	input high I	TGA,B,C		10	20	uA	mask:=active high
I _{iLT}	input low I	TGA,B,C		0		uA	mask:=active high
I _{ohr}	output high I	OS,W,X,Y,Z		-20		mA	
I _{oLr}	output low I	OS,W,X,Y,Z		20		mA	
I _{co}	current output	Cout		3.7		mA	half scale, curve Ico 3
V _{co}	Current o/p V	Cout				mV	
R1	Oscillation R	Rosc		600		Kohm	SR=6 KHz
R1	Oscillation R	Rosc		450		Kohm	SR=8 KHz
R1	Oscillation R			240		Kohm	SR=15 KHz
R2	Bypass R					ohm	
R _{cds}	max contact R					Kohm	
d F/F	Frq. stability			+/- 5		%	[F(4.5V)-F(4.0V)]/F(4.5V)
d F/F	Frq. variation			+/- 10		%	lot by lot

Specifications subject to change without notice, contact your sales representatives for the most recent information.

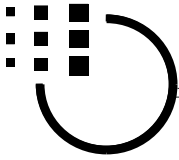

AC Characteristics at 6000 Hz S.R.

Timing	Description	Min.	Typ.	Max.	Unit	Remark
t ONL	LED turn on time (slow)	-	340	-	ms	SRD
t T	Trigger Pulse width (fast)	-	-	-	us	SRD
t T	Trigger Pulse width (normal)	21	-	-	ms	SRD
t TB	Lag from trigger to busy start	-	20	-	ms	SRD
t RMU	Ramp up width	-	20	-	ms	SRD
t RMD	Ramp down width	-	20	-	ms	SRD
t PL	Plain width behind sound	-	40	-	ms	SRD
t VB	Lag from voice end to busy end	-	0	-	ms	SRD
t BS	Lag from busy end to stop start	-	0	-	ms	SRD
t STP	Stop pulse width	-	40	-	ms	SRD
t P	Power Rise up time	-	-	1	ms	
t R	Power ripple width	-	-	1	ms	

SRD : Sample Rate Dependent

COB Information I

Silk screen & copper print
COB model number : MVI-P28



Legend

- Copper pad
- Chip covered

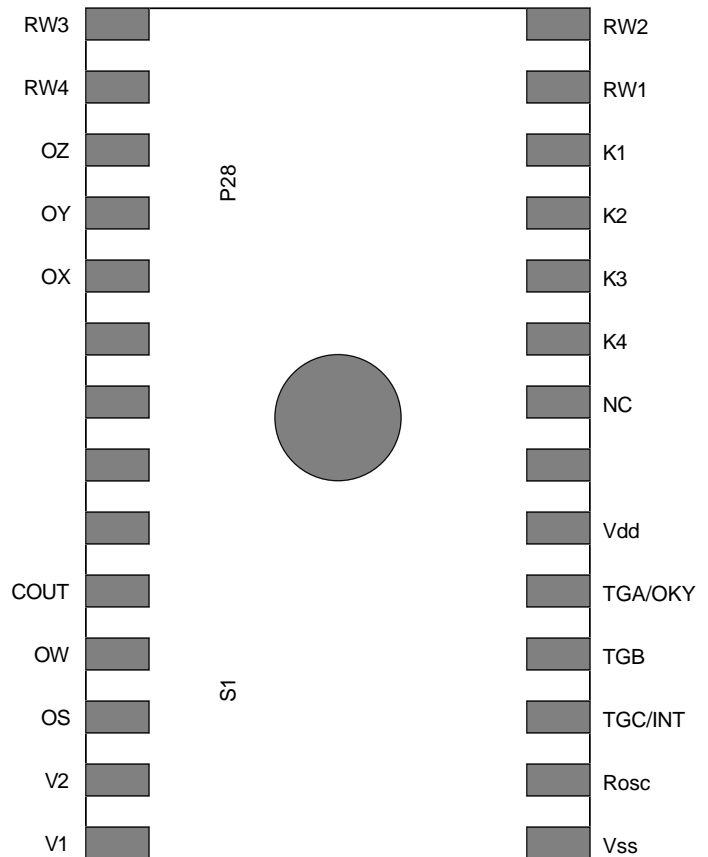

Specifications subject to change without notice, contact your sales representatives for the most recent information.

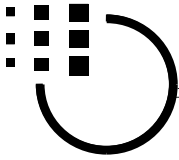

COB Information II

Silk screen & copper print
 COB model number : MSM9226
 Board size : 100 mm x 80 mm
 Double size

Legend

- Through hole
- LED lamp
- Chip covered
- copper pad & through hole
- copper pad & through hole
- copper pad & through hole

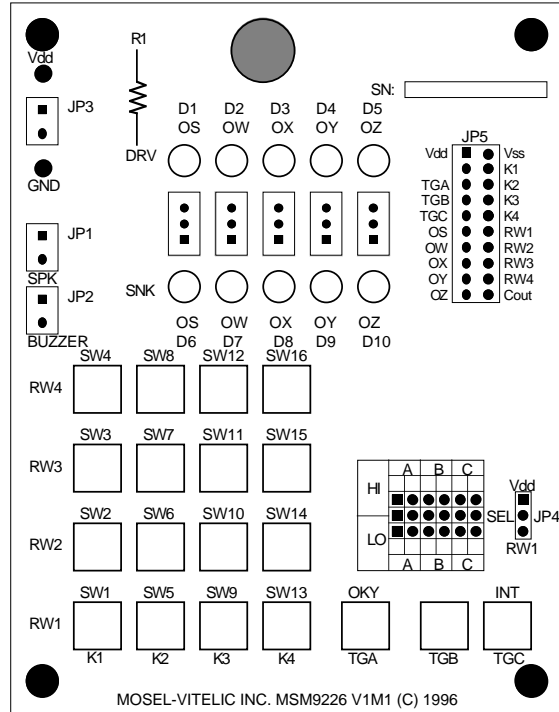

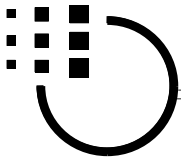

Timing Critical

I. Acceptable Power On Signal & Ripple

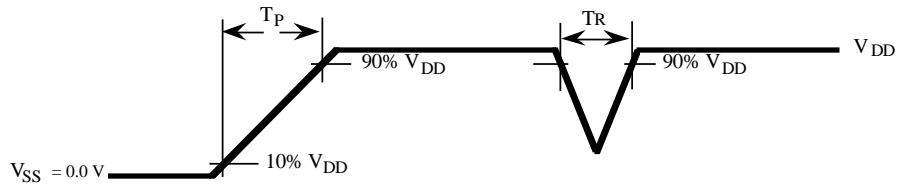

II. To play a voice sound

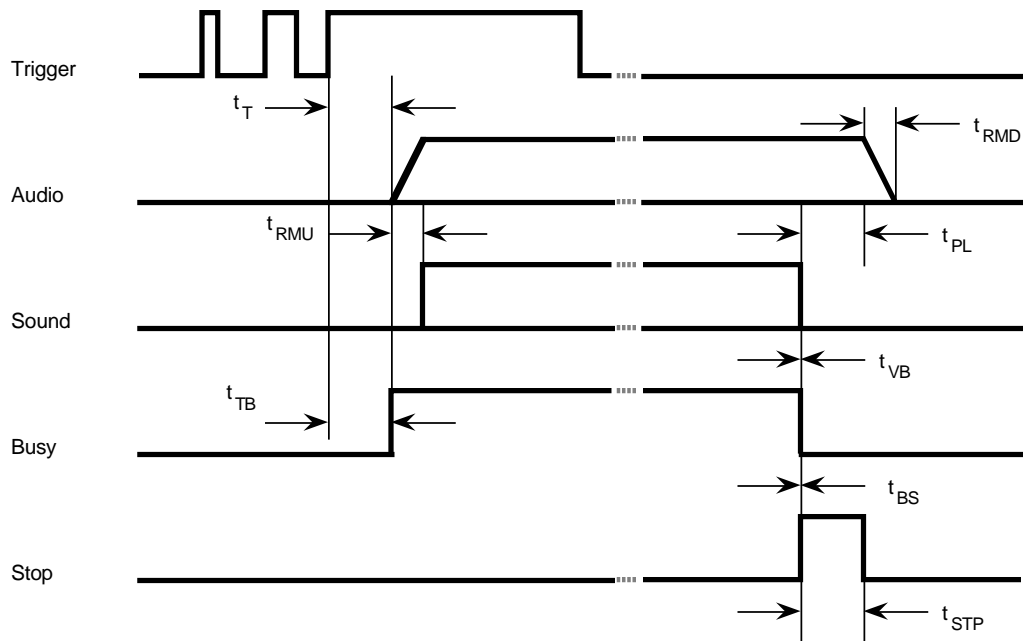

Specifications subject to change without notice, contact your sales representatives for the most recent information.

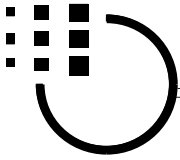

Timing Diagram

I.1 Edge/Unholdable/Retrigger/LED/STOP/BUSY Trigger Mask

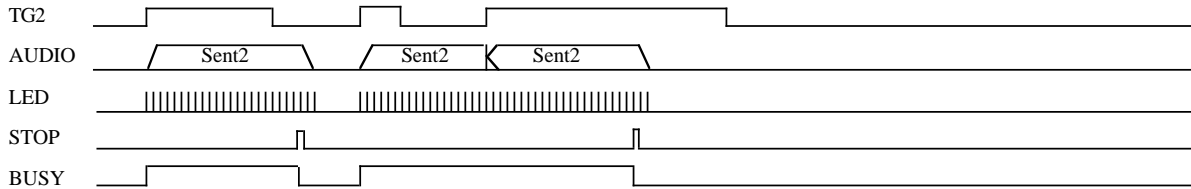

I.2 Level/Unholdable/Retrigger/LED/STOP/BUSY Trigger Mask

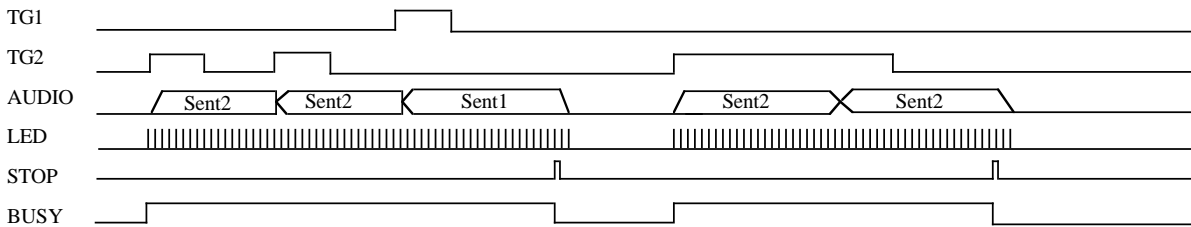

II.1 Edge/Holdable/Retrigger/LED/STOP/BUSY Trigger Mask

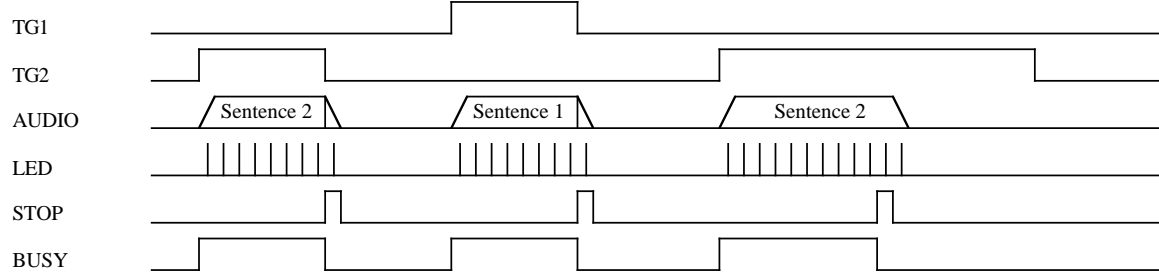

II.2 Level/Holdable/Retrigger/LED/STOP/BUSY Trigger Mask

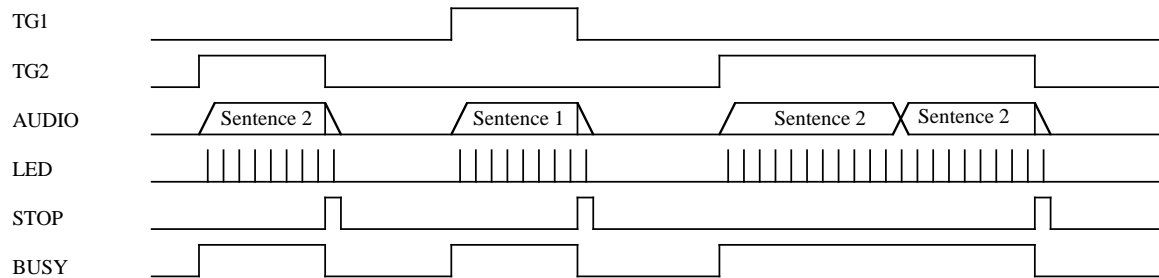

Specifications subject to change without notice, contact your sales representatives for the most recent information.

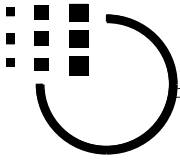

III.1 Lower Key priority 1

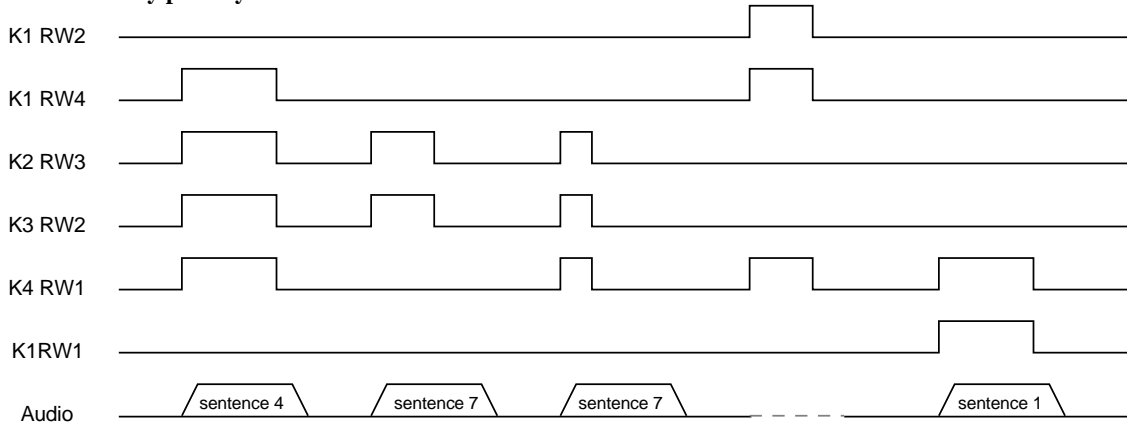

III.2 Lower Key priority 2

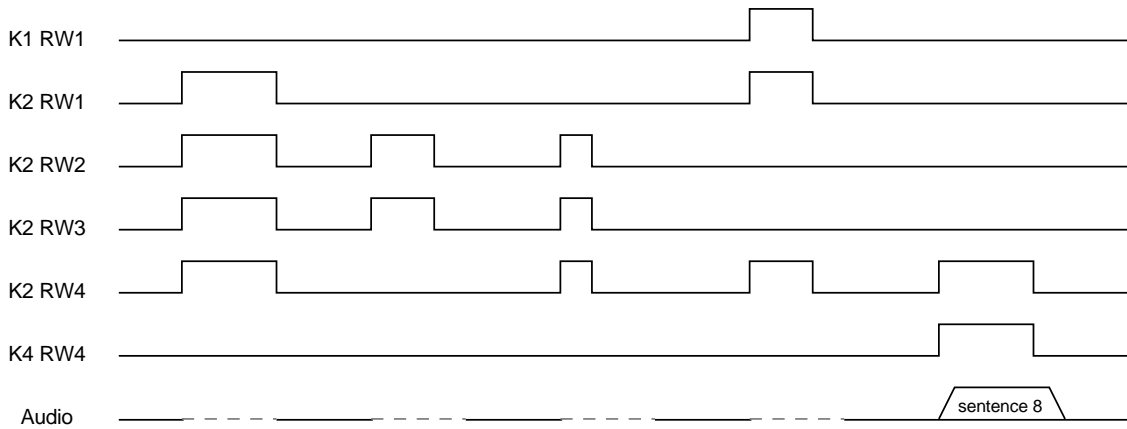

III.3 Lower Key priority 3

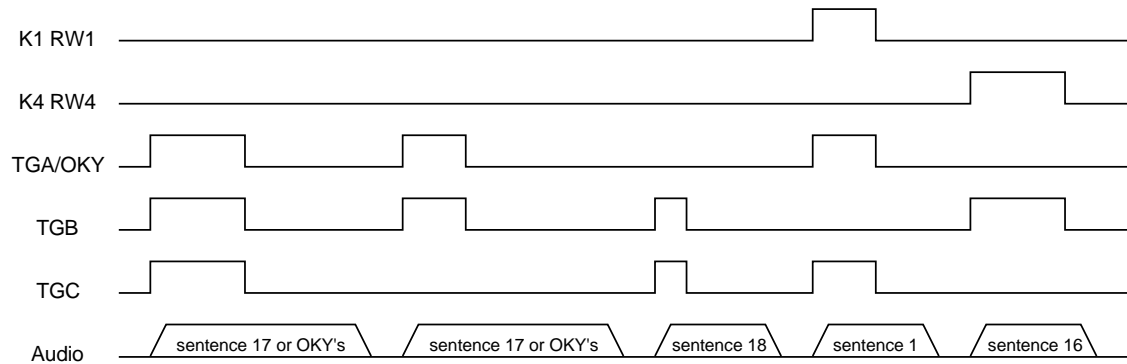

Specifications subject to change without notice, contact your sales representatives for the most recent information.

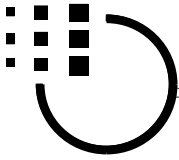

III. 4 Triggered at different time 1, Last key priority and else

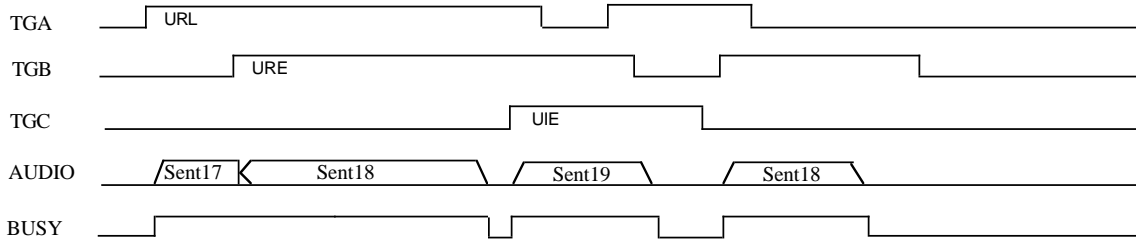

Legend : E : = masked as Edge trigger type
 I : = masked as Irretriggerable
 L : = masked as Level trigger type
 R : = masked as Retriggerable
 U : = masked as Holdable audio output

III. 5 Triggered at different time 2, Last key priority and else

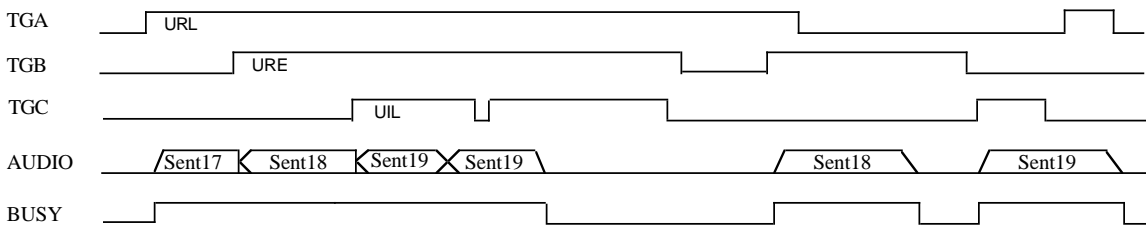

Legend : The same as those in III.2

III. 6 Triggers Overlapped, Last key priority for TGs

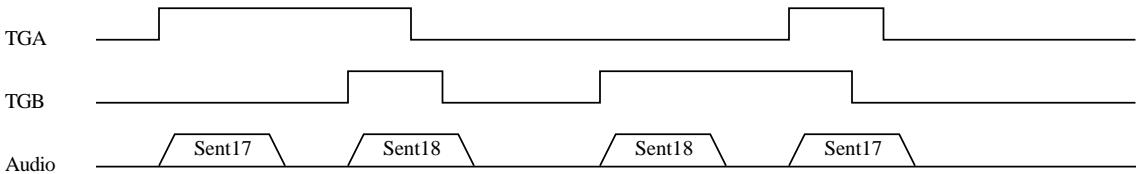

III. 7 Triggers Overlapped, First key priority for matrix at a column

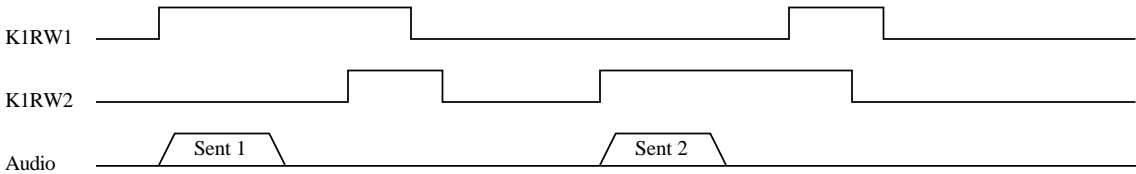

III. 8 Triggers Overlapped, First key priority for matrix at a row

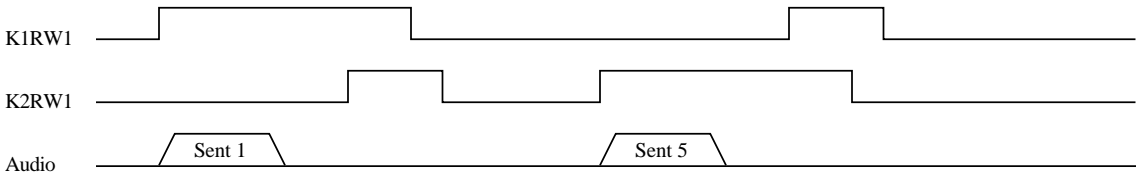

Specifications subject to change without notice, contact your sales representatives for the most recent information.

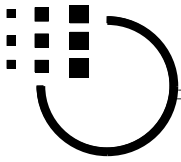

III. 9 Triggers Overlapped, First key priority for matrix

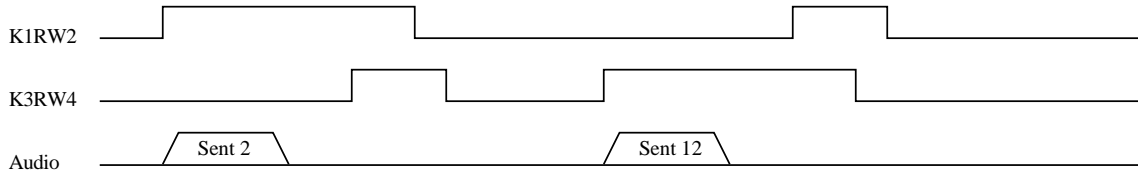

IV. 1 LED Ring Flash

All 5 output pins are masked as LED Ring Flash and speed is identical at slow speed.
LEDs are sunk.

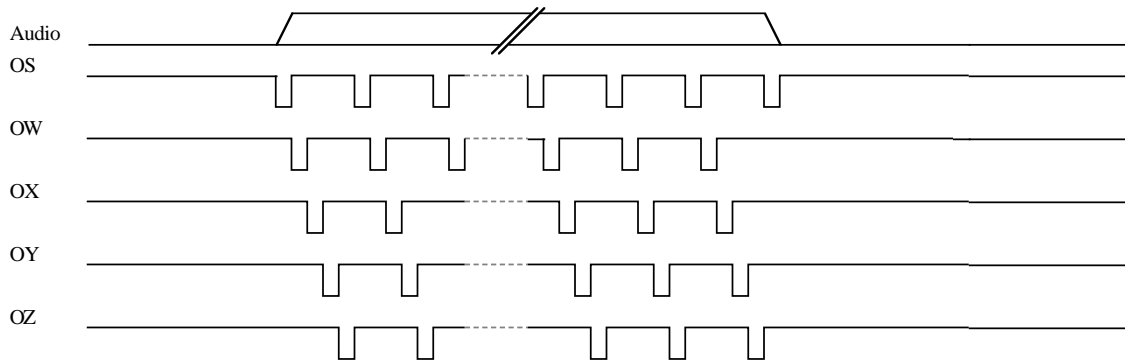

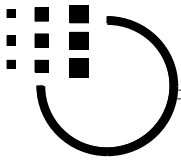

IV. 2 LED Ring Flash Inverse

All 5 outputs are masked as LED Ring Flash Inversed and speed is identical at slow speed.
LEDs are sunk.

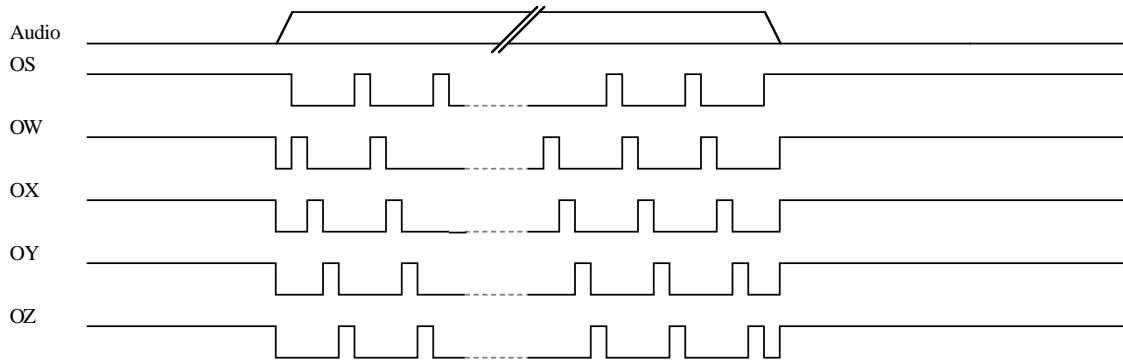

IV. 3 LED Ring Flash

Four LEDs are masked as LED Ring Flash and speed is identical at slow speed.
LEDs are sunk.

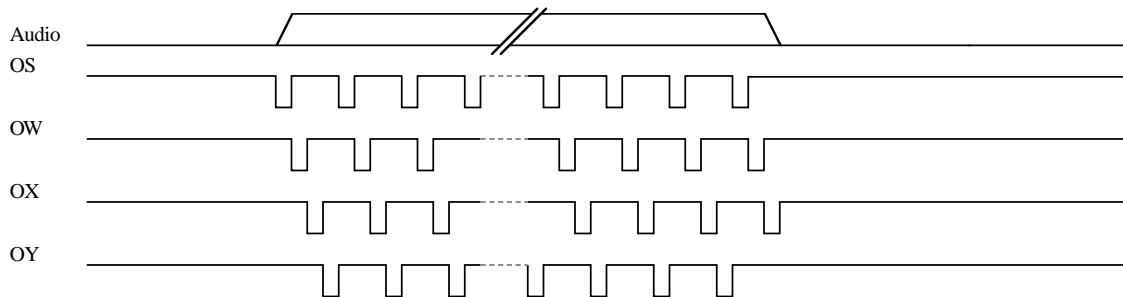

IV. 4 LED Ring Flash

Three LEDs are masked as LED Ring Flash and speed is identical at slow speed.
LEDs are sunk.

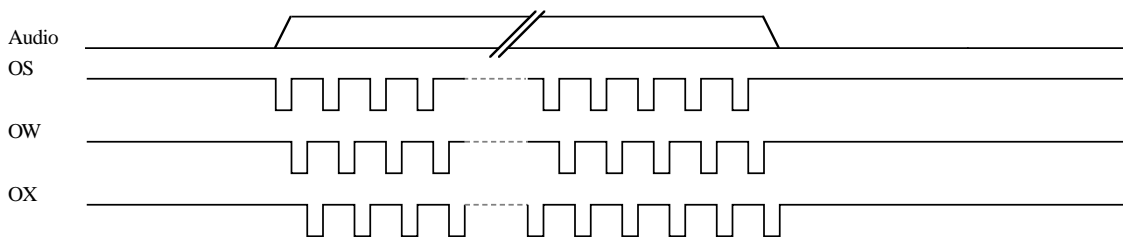

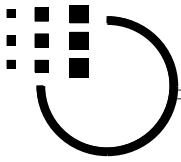

V. 1 LED Fix Flash

All 5 output pins are masked as LED Fix Flash and speed is identical at slow speed. LEDs are sunk.

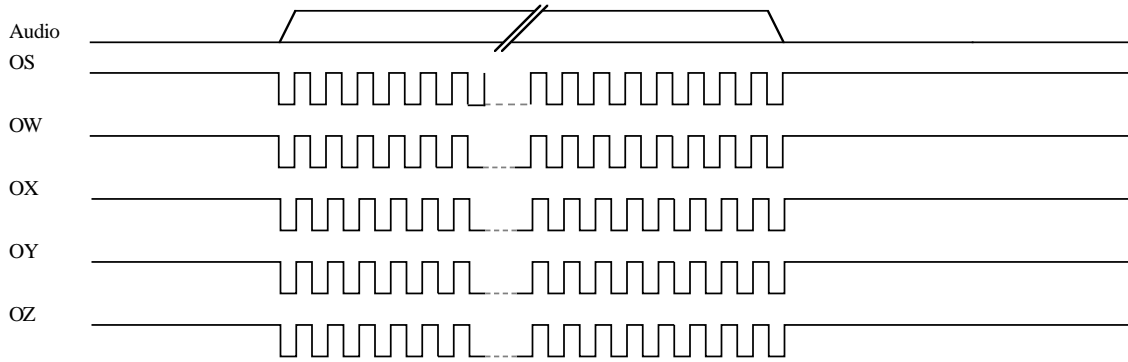

V. 2 LED Fix Flash

OS pin is masked as LED fix flash. All other 4 output pins are masked as LED fix flash inverted. These 5 LED output pins have identical speed. LEDs are sunk.

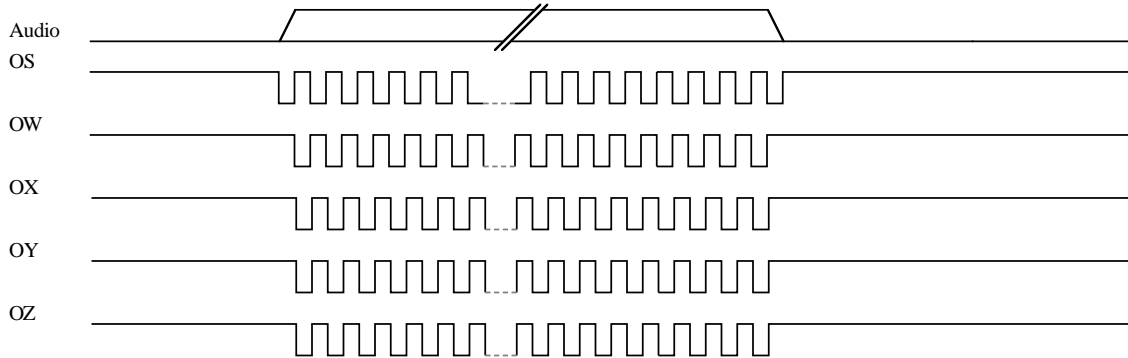

VI. 1 Busy at initial high

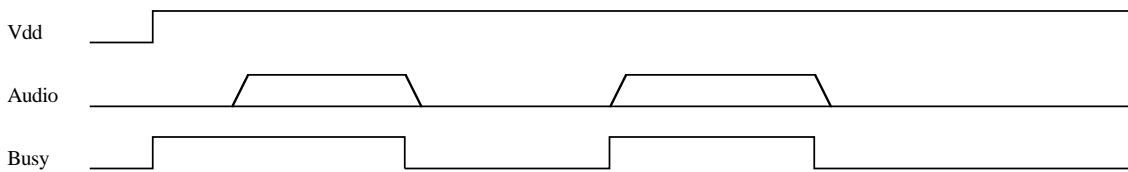

VI. 2 Stop at initial high

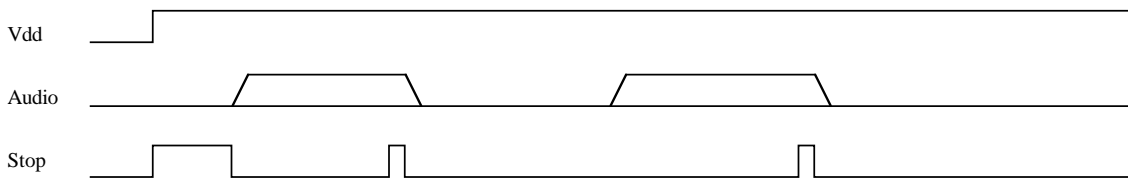

Specifications subject to change without notice, contact your sales representatives for the most recent information.

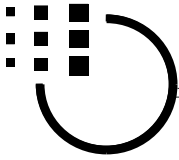

VI. 3 LED flash inverse at initial high (LED is sunk)

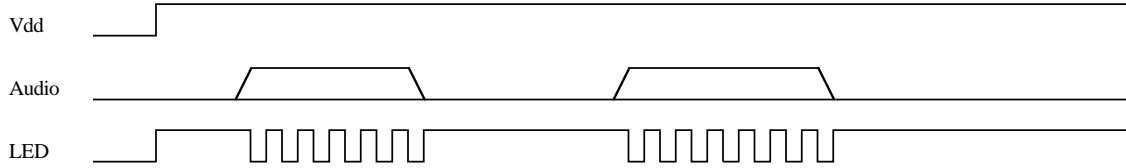

VI. 4 LED flash at initial high (LED is sunk)

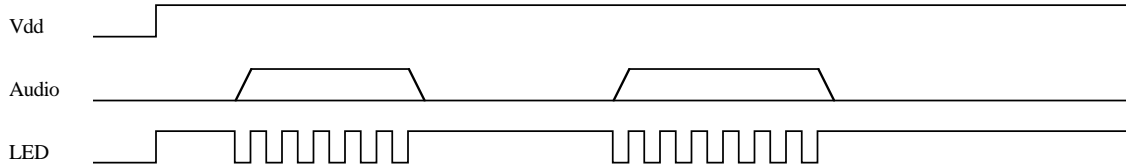

VII. 1 Busy at initial low

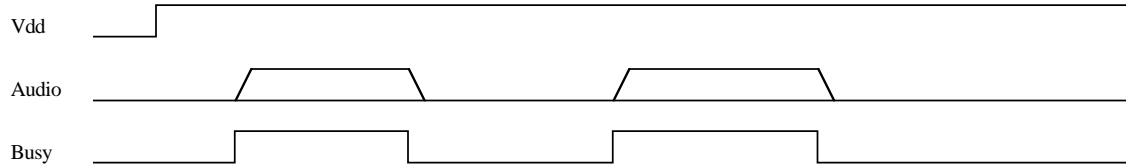

VII. 2 Stop at initial low

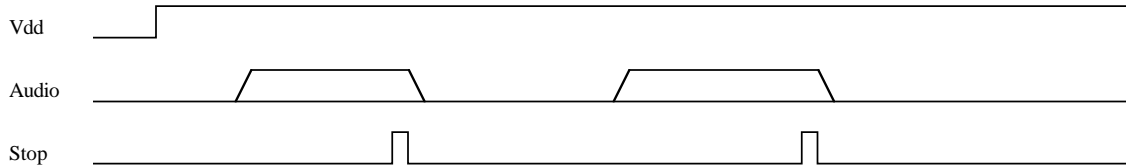

VII. 3 LED flash at initial low (LED is sunk)

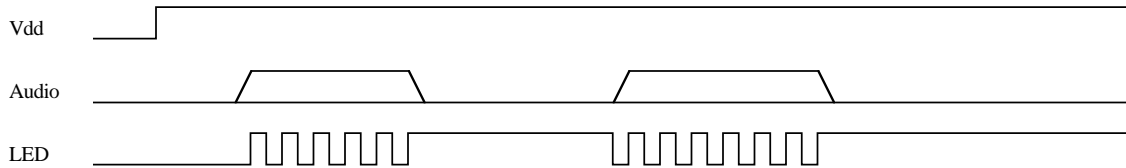

VII. 4 LED flash inverse at initial low (LED is sunk)

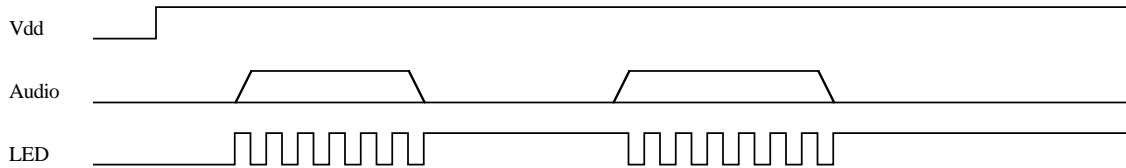

Specifications subject to change without notice, contact your sales representatives for the most recent information.

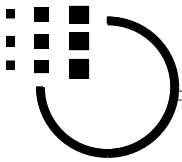

Application Circuits

I. Straight 7 Triggers

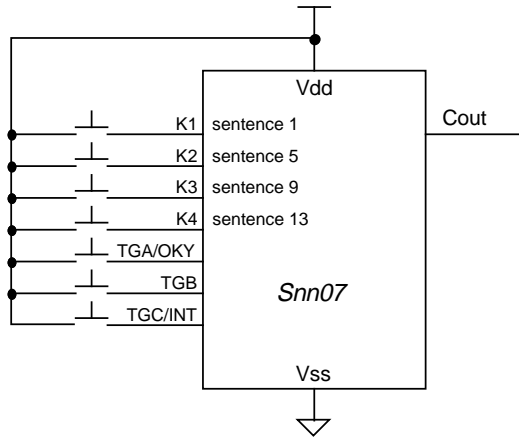

II. To limit current at LED

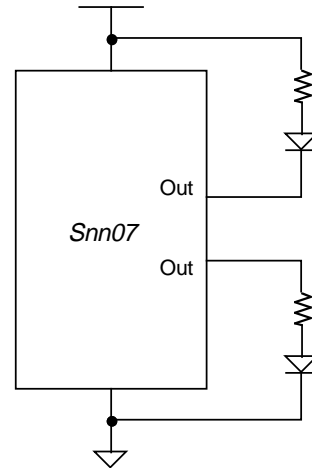

III. M9226 demo COB circuit

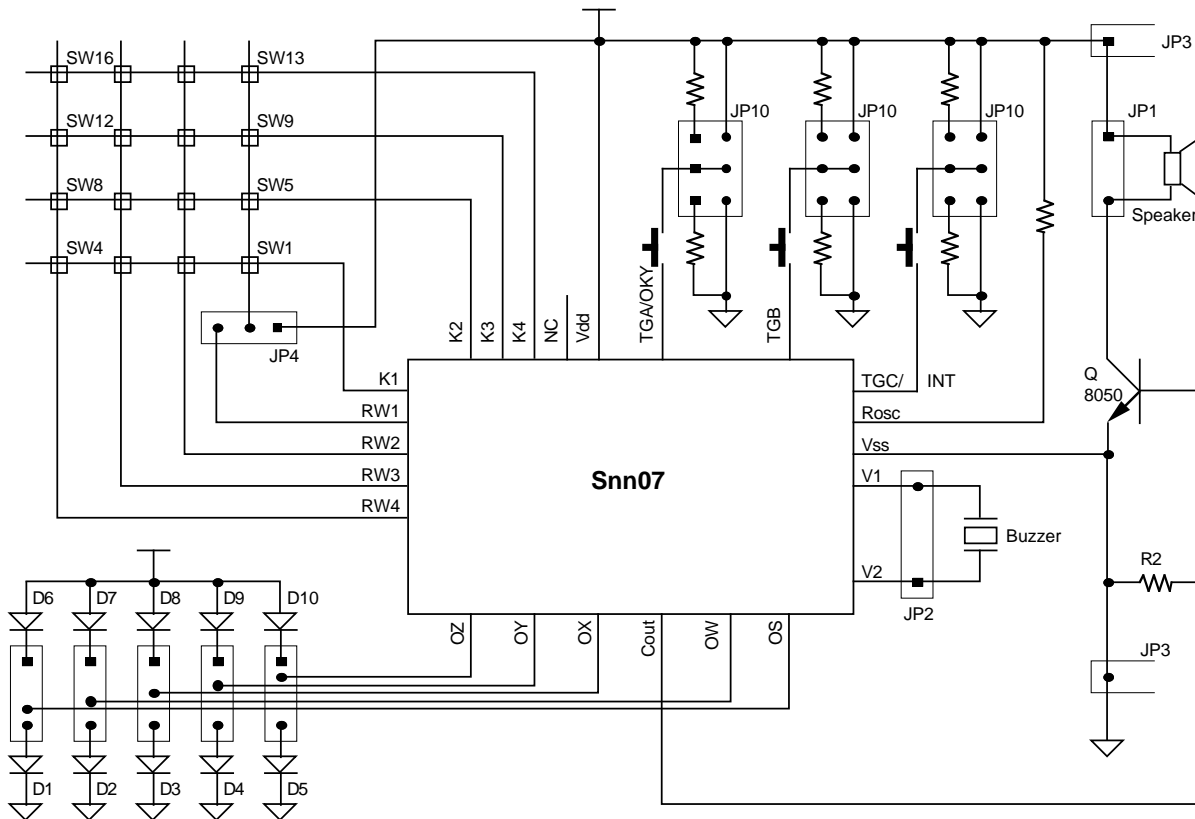

Specifications subject to change without notice, contact your sales representatives for the most recent information.

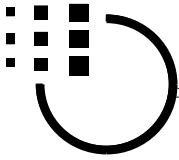

Pad Information

Pad#	Signal	X	Y
1	V2	-503	-706
2	V1	-269	-706
3	Vss	-36	-706
4	Rosc	220	-706
5	TGC/INT	453	-706
6	TGB	699	-624
7	TGA/OKY	699	-447
8	Vdd	699	-175
9	NC	699	-27
10	K4	699	185
11	K3	699	398
12	K2	699	611
13	K1	522	706
14	RW1	299	706
15	RW2	63	706
16	RW3	-173	706
17	RW4	-409	706
18	OZ	-699	552
19	OY	-699	318
20	OX	-699	82
21	COUT	-699	-226
22	OW	-699	-460
23	OS	-699	-696

IV. Typical Application Circuit

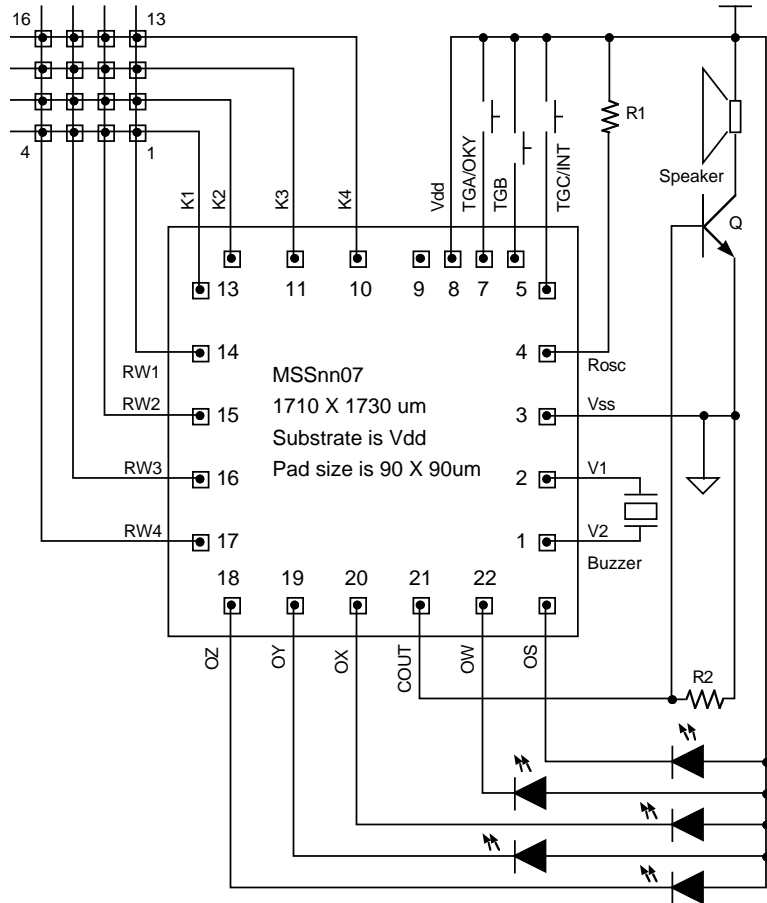

Taiwan
 #1 Creation Road I,
 Science - based Industrial Park,
 Hsinchu, 30077
 Taiwan, ROC
 "audio_reply@ccmail.mosel.com.tw"
 TEL: 886-3-5770055
 FAX: 886-3-5772788
 FAX: 886-3-5784732

Taipei
 7F, #102 Section 3,
 Ming Chung E. Road,
 Taipei, 105
 Taiwan, ROC
 TEL: 886-2-5451213
 FAX: 886-2-5451214

China
 (Vitellic HKG ShenZhen)
 Room #209,
 #19 ZhenHua road,
 ShenZhen, China
 TEL: 86-755-334-5766
 FAX: 86-755-332-3995

Hongkong
 #19 Dai Fu Street,
 Taipo Industrial Estate,
 Taipo, N.T.
 Hongkong
 TEL: 852-2388-8277 (MKO)
 TEL: 852-2665-4883
 FAX: 852-2664-2406
 FAX: 852-2770-8011 (MKO)

U.S.A.
 #3910 North First Street,
 San Jose,
 CA. 65134-1501
 U.S.A.
 TEL: 1-408-433-6000
 FAX: 1-408-433-0952

Specifications subject to change without notice, contact your sales representatives for the most recent information.

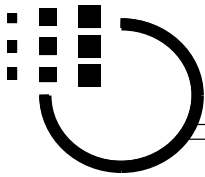

To : Mosel Vitelic Inc. 886-3-577-2788 (fax)

Attn : Sales & Marketing Department

Product Request Form

I hereby request MVI to start preparing produce **MSS1207** which is specified as below description as well as attached form(s). I already read this data sheet PID247 *** and understand **MSS1207** completely and know how to specify to fit my requirement. Its voice storage limitation is 11A00h.

General Descriptions		Chip descriptions	
Customer	_____	<input type="checkbox"/> TGA <input type="checkbox"/> OKY	Title
	Cannot proceed when empty	<input type="checkbox"/> No use & don't care	SampleRate
Agent	_____	<input type="checkbox"/> TGC <input type="checkbox"/> INT	Output
Sales	_____	<input type="checkbox"/> No use & don't care	Device
Repr'tives	Who is MVI sales you contact ?	<input type="checkbox"/> Ring 5 LEDs	<input type="checkbox"/> Buzzer (F fr =1KHz)
Providing to MVI	<input type="checkbox"/> 8-bit PCM sound files <input type="checkbox"/> .WAV sound files <input type="checkbox"/> DAT or equivalent <input type="checkbox"/> application is special, see our written memo <input type="checkbox"/> Others _____	<input type="checkbox"/> Ring 4 LEDs <input type="checkbox"/> Ring 3 LEDs <input type="checkbox"/> No Ring LED Specify below only for OKY <input type="checkbox"/> No use and don't care <input type="checkbox"/> Small Loop (17-32) <input type="checkbox"/> Large Loop (1-32)	<input type="checkbox"/> Speaker (0.25W, 8 ohm, 1" diam.) <input type="checkbox"/> Other: _____
Service Required from MVI	<input type="checkbox"/> EPROMs with data inside <input type="checkbox"/> files to be programmed into EPROM <input type="checkbox"/> 9026 emul'n board & Eprom <input type="checkbox"/> Confirm table <input type="checkbox"/> Others _____	<input type="checkbox"/> No use and don't care <input type="checkbox"/> CycleLoop=Sentenc.Count <input type="checkbox"/> CycleLoop=_____	Working Voltage <input type="checkbox"/> 2.5 V at curve 3 <input type="checkbox"/> 3.0 V at curve 3 <input type="checkbox"/> 3.5 V at curve 3 <input type="checkbox"/> 4.0 V at curve 3 <input type="checkbox"/> 4.5 V at curve 3 <input type="checkbox"/> 5.0 V at curve 3 <input type="checkbox"/> 5.5 V at curve 2 <input type="checkbox"/> 6.0 V at curve 2
		<input type="checkbox"/> No use and don't care <input type="checkbox"/> PlayAll <input type="checkbox"/> Play Random <input type="checkbox"/> PlayNext in Home sequence after Interrupt <input type="checkbox"/> PlayNext in Continue seque. after Interrupt	Power Source <input type="checkbox"/> Battery size "D" <input type="checkbox"/> Battery size "AA" <input type="checkbox"/> Battery size "AAA" <input type="checkbox"/> other size = _____ <input type="checkbox"/> Mains <input type="checkbox"/> Other _____

- Form N is attached due to this Single page form meets my need.
- Forms J, F and H are attached due to these quick forms meet my demand.
- Form G, F, A8, 7, 6, 5, 4, 3, 2, 1 are attached due to my application is delicate.

Company Name : _____ Fax number : _____

Signature : _____ Date : _____

Department/Section : _____ Position Title : _____

Specifications subject to change without notice, contact your sales representatives for the most recent information.

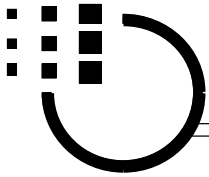

To : Mosel Vitelic Inc. 886-3-577-2788 (fax)

Attn : Sales & Marketing Department

Product Request Form

I hereby request MVI to start preparing produce **MSS0907** which is specified as below description as well as attached form(s). I already read this data sheet PID247 *** and understand **MSS0907** completely and know how to specify to fit my requirement. Its voice storage limitation is D800h.

General Descriptions		Chip descriptions	
Customer	_____	<input type="checkbox"/> TGA <input type="checkbox"/> OKY	Title
	Cannot proceed when empty	<input type="checkbox"/> No use & don't care	SampleRate
Agent	_____	<input type="checkbox"/> TGC <input type="checkbox"/> INT	Output
Sales	_____	<input type="checkbox"/> No use & don't care	Device
Repr'tives	Who is MVI sales you contact ?	<input type="checkbox"/> Ring 5 LEDs	<input type="checkbox"/> Buzzer (F fr =1KHz)
Providing to MVI	<input type="checkbox"/> 8-bit PCM sound files <input type="checkbox"/> .WAV sound files <input type="checkbox"/> DAT or equivalent <input type="checkbox"/> application is special, see our written memo <input type="checkbox"/> Others _____	<input type="checkbox"/> Ring 4 LEDs	<input type="checkbox"/> Speaker (0.25W, 8 ohm, 1" diam.)
		<input type="checkbox"/> Ring 3 LEDs	<input type="checkbox"/> Other: _____
Service Required from MVI	<input type="checkbox"/> EPROMs with data inside <input type="checkbox"/> files to be programmed into EPROM <input type="checkbox"/> 9026 emul'n board & Eprom <input type="checkbox"/> Confirm table <input type="checkbox"/> Others _____	<input type="checkbox"/> No Ring LED	Working Voltage
		Specify below only for OKY	
		<input type="checkbox"/> No use and don't care	<input type="checkbox"/> 3.0 V at curve 3
		<input type="checkbox"/> Small Loop (17-32)	<input type="checkbox"/> 3.5 V at curve 3
		<input type="checkbox"/> Large Loop (1-32)	<input type="checkbox"/> 4.0 V at curve 3
		<input type="checkbox"/> No use and don't care	<input type="checkbox"/> 4.5 V at curve 3
		<input type="checkbox"/> CycleLoop=Sentenc.Count	<input type="checkbox"/> 5.0 V at curve 3
		<input type="checkbox"/> CycleLoop=_____	<input type="checkbox"/> 5.5 V at curve 2
		<input type="checkbox"/> No use and don't care	<input type="checkbox"/> 6.0 V at curve 2
		<input type="checkbox"/> PlayAll	Power Source
		<input type="checkbox"/> Play Random	
		<input type="checkbox"/> PlayNext in Home sequence after Interrupt	<input type="checkbox"/> Battery size "AA"
		<input type="checkbox"/> PlayNext in Continue sequ. after Interrupt	<input type="checkbox"/> Battery size "AAA"
			<input type="checkbox"/> other size = _____
			<input type="checkbox"/> Mains
			<input type="checkbox"/> Other _____

- Form N is attached due to this Single page form meets my need.
- Forms J, F and H are attached due to these quick forms meet my demand.
- Form G, F, A8, 7, 6, 5, 4, 3, 2, 1 are attached due to my application is delicate.

Company Name : _____ Fax number : _____

Signature : _____ Date : _____

Department/Section : _____ Position Title : _____

Specifications subject to change without notice, contact your sales representatives for the most recent information.

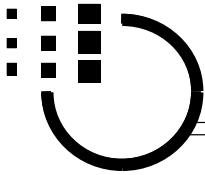

To : Mosel Vitelic Inc. 886-3-577-2788 (fax)

Attn : Sales & Marketing Department

Product Request Form

I hereby request MVI to start preparing produce **MSS0607** which is specified as below description as well as attached form(s). I already read this data sheet PID247 *** and understand **MSS0607** completely and know how to specify to fit my requirement. Its voice storage limitation is 9000h.

General Descriptions		Chip descriptions	
Customer	_____	<input type="checkbox"/> TGA <input type="checkbox"/> OKY	Title
	Cannot proceed when empty	<input type="checkbox"/> No use & don't care	SampleRate
Agent	_____	<input type="checkbox"/> TGC <input type="checkbox"/> INT	Output
Sales	_____	<input type="checkbox"/> No use & don't care	Device
Repr'tives	Who is MVI sales you contact ?	<input type="checkbox"/> Ring 5 LEDs	<input type="checkbox"/> Buzzer (F fr =1KHz)
Providing to MVI	<input type="checkbox"/> 8-bit PCM sound files <input type="checkbox"/> .WAV sound files <input type="checkbox"/> DAT or equivalent <input type="checkbox"/> application is special, see our written memo <input type="checkbox"/> Others _____	<input type="checkbox"/> Ring 4 LEDs <input type="checkbox"/> Ring 3 LEDs <input type="checkbox"/> No Ring LED Specify below only for OKY <input type="checkbox"/> No use and don't care <input type="checkbox"/> Small Loop (17-32) <input type="checkbox"/> Large Loop (1-32)	<input type="checkbox"/> Speaker (0.25W, 8 ohm, 1" diam.) <input type="checkbox"/> Other: _____
Service Required from MVI	<input type="checkbox"/> EPROMs with data inside <input type="checkbox"/> files to be programmed into EPROM <input type="checkbox"/> 9026 emul'n board & Eprom <input type="checkbox"/> Confirm table <input type="checkbox"/> Others _____	<input type="checkbox"/> No use and don't care <input type="checkbox"/> CycleLoop=Sentenc.Count <input type="checkbox"/> CycleLoop=_____	Working Voltage <input type="checkbox"/> 2.5 V at curve 3 <input type="checkbox"/> 3.0 V at curve 3 <input type="checkbox"/> 3.5 V at curve 3 <input type="checkbox"/> 4.0 V at curve 3 <input type="checkbox"/> 4.5 V at curve 3 <input type="checkbox"/> 5.0 V at curve 3 <input type="checkbox"/> 5.5 V at curve 2 <input type="checkbox"/> 6.0 V at curve 2
		<input type="checkbox"/> No use and don't care <input type="checkbox"/> PlayAll <input type="checkbox"/> Play Random <input type="checkbox"/> PlayNext in Home sequence after Interrupt <input type="checkbox"/> PlayNext in Continue seque. after Interrupt	Power Source <input type="checkbox"/> Battery size "D" <input type="checkbox"/> Battery size "AA" <input type="checkbox"/> Battery size "AAA" <input type="checkbox"/> other size = _____ <input type="checkbox"/> Mains <input type="checkbox"/> Other _____

- Form N is attached due to this Single page form meets my need.
- Forms J, F and H are attached due to these quick forms meet my demand.
- Form G, F, A8, 7, 6, 5, 4, 3, 2, 1 are attached due to my application is delicate.

Company Name : _____ Fax number : _____

Signature : _____ Date : _____

Department/Section : _____ Position Title : _____

Specifications subject to change without notice, contact your sales representatives for the most recent information.

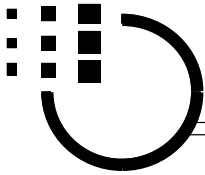

To : Mosel Vitelic Inc. 886-3-577-2788 (fax)

Attn : Sales & Marketing Department

Product Request Form

I hereby request MVI to start preparing produce **MSS0307** which is specified as below description as well as attached form(s). I already read this data sheet PID247 *** and understand **MSS0307** completely and know how to specify to fit my requirement. Its voice storage limitation is 5100h.

General Descriptions		Chip descriptions	
Customer	_____	<input type="checkbox"/> TGA <input type="checkbox"/> OKY	Title
	Cannot proceed when empty	<input type="checkbox"/> No use & don't care	SampleRate
Agent	_____	<input type="checkbox"/> TGC <input type="checkbox"/> INT	Output
Sales	_____	<input type="checkbox"/> No use & don't care	Device
Repr'tives	Who is MVI sales you contact ?	<input type="checkbox"/> Ring 5 LEDs	<input type="checkbox"/> Buzzer (F fr =1KHz)
Providing to MVI	<input type="checkbox"/> 8-bit PCM sound files <input type="checkbox"/> .WAV sound files <input type="checkbox"/> DAT or equivalent <input type="checkbox"/> application is special, see our written memo <input type="checkbox"/> Others _____	<input type="checkbox"/> Ring 4 LEDs <input type="checkbox"/> Ring 3 LEDs <input type="checkbox"/> No Ring LED Specify below only for OKY <input type="checkbox"/> No use and don't care <input type="checkbox"/> Small Loop (17-32) <input type="checkbox"/> Large Loop (1-32)	<input type="checkbox"/> Speaker (0.25W, 8 ohm, 1" diam.) <input type="checkbox"/> Other: _____
Service Required from MVI	<input type="checkbox"/> EPROMs with data inside <input type="checkbox"/> files to be programmed into EPROM <input type="checkbox"/> 9026 emul'n board & Eprom <input type="checkbox"/> Confirm table <input type="checkbox"/> Others _____	<input type="checkbox"/> No use and don't care <input type="checkbox"/> CycleLoop=Sentenc.Count <input type="checkbox"/> CycleLoop=_____	Working Voltage <input type="checkbox"/> 2.5 V at curve 3 <input type="checkbox"/> 3.0 V at curve 3 <input type="checkbox"/> 3.5 V at curve 3 <input type="checkbox"/> 4.0 V at curve 3 <input type="checkbox"/> 4.5 V at curve 3 <input type="checkbox"/> 5.0 V at curve 3 <input type="checkbox"/> 5.5 V at curve 2 <input type="checkbox"/> 6.0 V at curve 2
		<input type="checkbox"/> No use and don't care <input type="checkbox"/> PlayAll <input type="checkbox"/> Play Random <input type="checkbox"/> PlayNext in Home sequence after Interrupt <input type="checkbox"/> PlayNext in Continue seque. after Interrupt	Power Source <input type="checkbox"/> Battery size "D" <input type="checkbox"/> Battery size "AA" <input type="checkbox"/> Battery size "AAA" <input type="checkbox"/> other size = _____ <input type="checkbox"/> Mains <input type="checkbox"/> Other _____

- Form N is attached due to this Single page form meets my need.
- Forms J, F and H are attached due to these quick forms meet my demand.
- Form G, F, A8, 7, 6, 5, 4, 3, 2, 1 are attached due to my application is delicate.

Company Name : _____ Fax number : _____

Signature : _____ Date : _____

Department/Section : _____ Position Title : _____

Specifications subject to change without notice, contact your sales representatives for the most recent information.

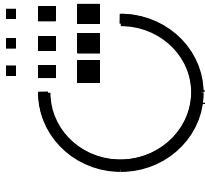

There are ≤ entries included in this sentence.

Product Request Form A1: Sentence

≤

Definitions

TITLE

--

There are ≤ words defined on this page.

	Section 31-0	Pitch 7-0	Loud 7-0	OS A-8	OW A-8	OX A-8	OY A-8	OZ A-8	
00									32
01									33
02									34
03									35
04									36
05									37
06									38
07									39
08									40
09									41
10									42
11									43
12									44
13									45
14									46
15									47
16									48
17									49
18									50
19									51
20									52
21									53
22									54
23									55
24									56
25									57
26									58
27									59
28									60
29									61
30									62
31									63

Page of

Signature & date

MVI Sales & date

Specifications subject to change without notice, contact your sales representatives for the most recent information.

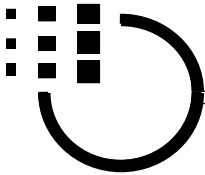

Product Request Form A2: Sentence

1 ≤ ≤ 32

Definitions

T I T L E

	Section 31-0	Pitch 7-0	Loud 7-0	OS A-8	OW A-8	OX A-8	OY A-8	OZ A-8
64								
65								
66								
67								
68								
69								
70								
71								
72								
73								
74								
75								
76								
77								
78								
79								
80								
81								
82								
83								
84								
85								
86								
87								
88								
89								
90								
91								
92								
93								
94								
95								

There are 1 ≤ ≤ 64 words defined on this page.

96								
97								
98								
99								
100								
101								
102								
103								
104								
105								
106								
107								
108								
109								
110								
111								
112								
113								
114								
115								
116								
117								
118								
119								
120								
121								
122								
123								
124								
125								
126								
127								

Page of

Signature & date

MVI Sales & date

Specifications subject to change without notice, contact your sales representatives for the most recent information.

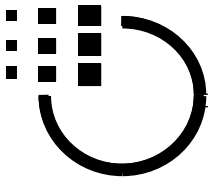

Product Request Form A3: Sentence **Definitions**

	Section 31-0	Pitch 7-0	Loud 7-0	OS A-8	OW A-8	OX A-8	OY A-8	OZ A-8	There are	<input type="text" value="1≤"/>	<input type="text" value="≤64"/>	words defined on this page.
128									160			
129									161			
130									162			
131									163			
132									164			
133									165			
134									166			
135									167			
136									168			
137									169			
138									170			
139									171			
140									172			
141									173			
142									174			
143									175			
144									176			
145									177			
146									178			
147									179			
148									180			
149									181			
150									182			
151									183			
152									184			
153									185			
154									186			
155									187			
156									188			
157									189			
158									190			
159									191			

Page of

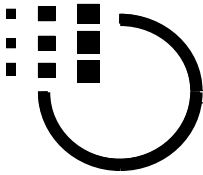

Product Request Form A4: Sentence ≤ Definitions

Section 31-0	Pitch 7-0	Loud 7-0	OS A-8	OW A-8	OX A-8	OY A-8	OZ A-8	There are <input type="text" value="1"/> ≤ <input type="text" value="64"/> words defined on this page.
192								224
193								225
194								226
195								227
196								228
197								229
198								230
199								231
200								232
201								233
202								234
203								235
204								236
205								237
206								238
207								239
208								240
209								241
210								242
211								243
212								244
213								245
214								246
215								247
216								248
217								249
218								250
219								251
220								252
221								253
222								254
223								255

Page of Signature & date MVI Sales & date

Specifications subject to change without notice, contact your sales representatives for the most recent information.

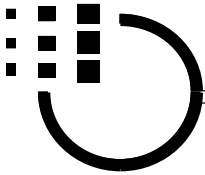

Product Request Form A5: Sentence 1 ≤ ≤32

Definitions

T I T L E

	Section 31-0	Pitch 7-0	Loud 7-0	OS A-8	OW A-8	OX A-8	OY A-8	OZ A-8
256								
257								
258								
259								
260								
261								
262								
263								
264								
265								
266								
267								
268								
269								
270								
271								
272								
273								
274								
275								
276								
277								
278								
279								
280								
281								
282								
283								
284								
285								
286								
287								

There are 1 ≤ ≤64 words defined on this page.

288								
289								
290								
291								
292								
293								
294								
295								
296								
297								
298								
299								
300								
301								
302								
303								
304								
305								
306								
307								
308								
309								
310								
311								
312								
313								
314								
315								
316								
317								
318								
319								

Page of Signature & date MVI Sales & date

Specifications subject to change without notice, contact your sales representatives for the most recent information.

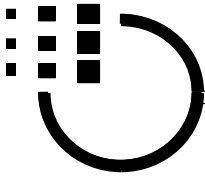

Product Request Form A6: Sentence ≤ **Definitions**

Product Request Form A6: Sentence									Definitions					
Section 31-0	Pitch 7-0	Loud 7-0	OS A-8	OW A-8	OX A-8	OY A-8	OZ A-8		There are <input type="text" value="1"/> ≤ <input type="text" value="64"/> words defined on this page.					
320									352					
321									353					
322									354					
323									355					
324									356					
325									357					
326									358					
327									359					
328									360					
329									361					
330									362					
331									363					
332									364					
333									365					
334									366					
335									367					
336									368					
337									369					
338									370					
339									371					
340									372					
341									373					
342									374					
343									375					
344									376					
345									377					
346									378					
347									379					
348									380					
349									381					
350									382					
351									383					

Page of Signature & date MVI Sales & date

Specifications subject to change without notice, contact your sales representatives for the most recent information.

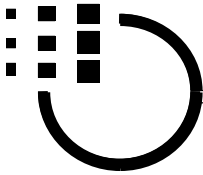

Product Request Form A7: Sentence ≤ **Definitions**

	Section 31-0	Pitch 7-0	Loud 7-0	OS A-8	OW A-8	OX A-8	OY A-8	OZ A-8	There are	<input type="text" value="1"/> ≤	<input type="text" value="64"/> ≤	words defined on this page.
384									416			
385									417			
386									418			
387									419			
388									420			
389									421			
390									422			
391									423			
392									424			
393									425			
394									426			
395									427			
396									428			
397									429			
398									430			
399									431			
400									432			
401									433			
402									434			
403									435			
404									436			
405									437			
406									438			
407									439			
408									440			
409									441			
410									442			
411									443			
412									444			
413									445			
414									446			
415									447			

Page of

Specifications subject to change without notice, contact your sales representatives for the most recent information.

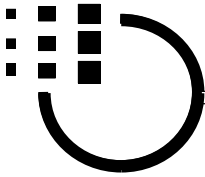

Product Request Form A8: Sentence ≤

Definitions

	Section 31-0	Pitch 7-0	Loud 7-0	OS A-8	OW A-8	OX A-8	OY A-8	OZ A-8
448								
449								
450								
451								
452								
453								
454								
455								
456								
457								
458								
459								
460								
461								
462								
463								
464								
465								
466								
467								
468								
469								
470								
471								
472								
473								
474								
475								
476								
477								
478								
479								

There are ≤ words defined on this page.

480								
481								
482								
483								
484								
485								
486								
487								
488								
489								
490								
491								
492								
493								
494								
495								
496								
497								
498								
499								
500								
501								
502								
503								
504								
505								
506								
507								
508								
509								
510								
511								

Page of Signature & date MVI Sales & date

Specifications subject to change without notice, contact your sales representatives for the most recent information.

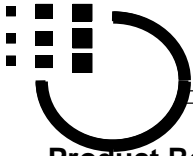

Product Request Form F: Word Section Definition

TITLE

Address	Voice Description	Voice Length		Mute Length		File name	Check Sum
0		s	ooh	s	ooh		h
1		s	ooh	s	ooh		h
2		s	ooh	s	ooh		h
3		s	ooh	s	ooh		h
4		s	ooh	s	ooh		h
5		s	ooh	s	ooh		h
6		s	ooh	s	ooh		h
7		s	ooh	s	ooh		h
8		s	ooh	s	ooh		h
9		s	ooh	s	ooh		h
10		s	ooh	s	ooh		h
11		s	ooh	s	ooh		h
12		s	ooh	s	ooh		h
13		s	ooh	s	ooh		h
14		s	ooh	s	ooh		h
15		s	ooh	s	ooh		h
16		s	ooh	s	ooh		h
17		s	ooh	s	ooh		h
18		s	ooh	s	ooh		h
19		s	ooh	s	ooh		h
20		s	ooh	s	ooh		h
21		s	ooh	s	ooh		h
22		s	ooh	s	ooh		h
23		s	ooh	s	ooh		h
24		s	ooh	s	ooh		h
25		s	ooh	s	ooh		h
26		s	ooh	s	ooh		h
27		s	ooh	s	ooh		h
28		s	ooh	s	ooh		h
29		s	ooh	s	ooh		h
30		s	ooh	s	ooh		h
31		s	ooh	s	ooh		h

There are ≤ words defined on this form F and their length sum'n is (≤ limit).

Signature & date	MVI Sales & Date
------------------	------------------

Specifications subject to change without notice, contact your sales representatives for the most recent information.

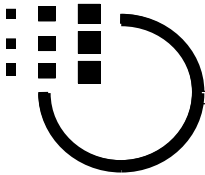

Product Request Form G: (Trigger / Sentence dependent)

TITLE	
--------------	--

***Trigger Option Definition:**

TGA OKY	<input type="checkbox"/> Edge <input type="checkbox"/> Level	<input type="checkbox"/> Active High <input type="checkbox"/> Active Low	<input type="checkbox"/> Hold & Irretrigger <input type="checkbox"/> Hold & Retrigger	<input type="checkbox"/> Unhold & Irretrigger <input type="checkbox"/> Unhold & Retrigger	<input type="checkbox"/> Don't care
TGB	<input type="checkbox"/> Edge <input type="checkbox"/> Level	<input type="checkbox"/> Active High <input type="checkbox"/> Active Low	<input type="checkbox"/> Hold & Irretrigger <input type="checkbox"/> Hold & Retrigger	<input type="checkbox"/> Unhold & Irretrigger <input type="checkbox"/> Unhold & Retrigger	<input type="checkbox"/> Don't care
TGC INT	<input type="checkbox"/> Edge <input type="checkbox"/> Level	<input type="checkbox"/> Active High <input type="checkbox"/> Active Low	<input type="checkbox"/> Hold & Irretrigger <input type="checkbox"/> Hold & Retrigger	<input type="checkbox"/> Unhold & Irretrigger <input type="checkbox"/> Unhold & Retrigger	<input type="checkbox"/> Don't care
K1	<input type="checkbox"/> Edge <input type="checkbox"/> Level	<input type="checkbox"/> Active High <input type="checkbox"/> Active Low	<input type="checkbox"/> Hold & Irretrigger <input type="checkbox"/> Hold & Retrigger	<input type="checkbox"/> Unhold & Irretrigger <input type="checkbox"/> Unhold & Retrigger	<input type="checkbox"/> Don't care
K2	<input type="checkbox"/> Edge <input type="checkbox"/> Level	<input type="checkbox"/> Active High <input type="checkbox"/> Active Low	<input type="checkbox"/> Hold & Irretrigger <input type="checkbox"/> Hold & Retrigger	<input type="checkbox"/> Unhold & Irretrigger <input type="checkbox"/> Unhold & Retrigger	<input type="checkbox"/> Don't care
K3	<input type="checkbox"/> Edge <input type="checkbox"/> Level	<input type="checkbox"/> Active High <input type="checkbox"/> Active Low	<input type="checkbox"/> Hold & Irretrigger <input type="checkbox"/> Hold & Retrigger	<input type="checkbox"/> Unhold & Irretrigger <input type="checkbox"/> Unhold & Retrigger	<input type="checkbox"/> Don't care
K4	<input type="checkbox"/> Edge <input type="checkbox"/> Level	<input type="checkbox"/> Active High <input type="checkbox"/> Active Low	<input type="checkbox"/> Hold & Irretrigger <input type="checkbox"/> Hold & Retrigger	<input type="checkbox"/> Unhold & Irretrigger <input type="checkbox"/> Unhold & Retrigger	<input type="checkbox"/> Don't care

Sentence & Their Entry Count

Trigger	Sentence	Entry Count
RW1 K1	1	
RW2 K1	2	
RW3 K1	3	
RW4 K1	4	
RW1 K2	5	
RW2 K2	6	
RW3 K2	7	
RW4 K2	8	
RW1 K3	9	
RW2 K3	10	
RW3 K3	11	

Trigger	Sentence	Entry Count
RW4 K3	12	
RW1 K4	13	
RW2 K4	14	
RW3 K4	15	
RW4 K4	16	
TGA	17	
TGB	18	
TGC	19	
OKY	20	
OKY	21	
OKY	22	

Trigger	Sentence	Entry Count
OKY	23	
OKY	24	
OKY	25	
OKY	26	
OKY	27	
OKY	28	
OKY	29	
OKY	30	
OKY	31	
OKY	32	
Summation ≤ 512		

Output definition on initial state

OS	OW	OX	OY	OZ
<input type="checkbox"/> initial High <input type="checkbox"/> initial Low <input type="checkbox"/> Don't care	<input type="checkbox"/> iH <input type="checkbox"/> iL <input type="checkbox"/> Dnc	<input type="checkbox"/> iH <input type="checkbox"/> iL <input type="checkbox"/> Dnc	<input type="checkbox"/> iH <input type="checkbox"/> iL <input type="checkbox"/> Dnc	<input type="checkbox"/> iH <input type="checkbox"/> iL <input type="checkbox"/> Dnc

Forms An's are attached.

Signature & date		MVI Sales & Date	
------------------	--	------------------	--

Specifications subject to change without notice, contact your sales representatives for the most recent information.

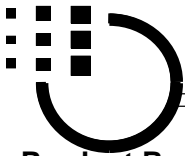

Product Request Form H : Sentence Table Definitions

TITLE

Trigger	Sentence	Sentence Definition (word section addresses)	Address count
K1RW1	1		
K1RW2	2		
K1RW3	3		
K1RW4	4		
K2RW1	5		
K2RW2	6		
K2RW3	7		
K2RW4	8		
K3RW1	9		
K3RW2	10		
K3RW3	11		
K3RW4	12		
K4RW1	13		
K4RW2	14		
K4RW3	15		
K4RW4	16		
TGA	17		
TGB	18		
TGC	19		
X	20		
X	21		
X	22		
X	23		
X	24		
X	25		
X	26		
X	27		
X	28		
X	29		
X	30		
X	31		
X	32		

There are 1 ≤ ≤32 sentences defined on this form H and their address entry sum'n = ≤512

Signature & date MVI Sales & date

Specifications subject to change without notice, contact your sales representatives for the most recent information.

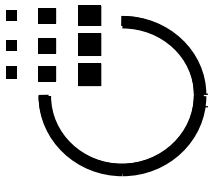

Product Request Form J:

TITLE	
--------------	--

***Trigger Option Definition:**

TGA OKY	<input type="checkbox"/> Edge	<input type="checkbox"/> Active High	<input type="checkbox"/> Hold & Irretrigger	<input type="checkbox"/> Unhold & Irretrigger	<input type="checkbox"/> Don't care
	<input type="checkbox"/> Level	<input type="checkbox"/> Active Low	<input type="checkbox"/> Hold & Retrigger	<input type="checkbox"/> Unhold & Retrigger	
TGB	<input type="checkbox"/> Edge	<input type="checkbox"/> Active High	<input type="checkbox"/> Hold & Irretrigger	<input type="checkbox"/> Unhold & Irretrigger	<input type="checkbox"/> Don't care
	<input type="checkbox"/> Level	<input type="checkbox"/> Active Low	<input type="checkbox"/> Hold & Retrigger	<input type="checkbox"/> Unhold & Retrigger	
TGC INT	<input type="checkbox"/> Edge	<input type="checkbox"/> Active High	<input type="checkbox"/> Hold & Irretrigger	<input type="checkbox"/> Unhold & Irretrigger	<input type="checkbox"/> Don't care
	<input type="checkbox"/> Level	<input type="checkbox"/> Active Low	<input type="checkbox"/> Hold & Retrigger	<input type="checkbox"/> Unhold & Retrigger	
K1	<input type="checkbox"/> Edge	<input type="checkbox"/> Active High	<input type="checkbox"/> Hold & Irretrigger	<input type="checkbox"/> Unhold & Irretrigger	<input type="checkbox"/> Don't care
	<input type="checkbox"/> Level	<input type="checkbox"/> Active Low	<input type="checkbox"/> Hold & Retrigger	<input type="checkbox"/> Unhold & Retrigger	
K2	<input type="checkbox"/> Edge	<input type="checkbox"/> Active High	<input type="checkbox"/> Hold & Irretrigger	<input type="checkbox"/> Unhold & Irretrigger	<input type="checkbox"/> Don't care
	<input type="checkbox"/> Level	<input type="checkbox"/> Active Low	<input type="checkbox"/> Hold & Retrigger	<input type="checkbox"/> Unhold & Retrigger	
K3	<input type="checkbox"/> Edge	<input type="checkbox"/> Active High	<input type="checkbox"/> Hold & Irretrigger	<input type="checkbox"/> Unhold & Irretrigger	<input type="checkbox"/> Don't care
	<input type="checkbox"/> Level	<input type="checkbox"/> Active Low	<input type="checkbox"/> Hold & Retrigger	<input type="checkbox"/> Unhold & Retrigger	
K4	<input type="checkbox"/> Edge	<input type="checkbox"/> Active High	<input type="checkbox"/> Hold & Irretrigger	<input type="checkbox"/> Unhold & Irretrigger	<input type="checkbox"/> Don't care
	<input type="checkbox"/> Level	<input type="checkbox"/> Active Low	<input type="checkbox"/> Hold & Retrigger	<input type="checkbox"/> Unhold & Retrigger	

***Output Definition:** Neither variable pitch nor variable loudness is used.

OS		OW		OX		OY		OZ	
<input type="checkbox"/> initial High	<input type="checkbox"/> initial Low	<input type="checkbox"/> iH	<input type="checkbox"/> iL	<input type="checkbox"/> iH	<input type="checkbox"/> iL	<input type="checkbox"/> iH	<input type="checkbox"/> iL	<input type="checkbox"/> iH	<input type="checkbox"/> iL
<input type="checkbox"/> Don't care		<input type="checkbox"/> Don't care		<input type="checkbox"/> Don't Care		<input type="checkbox"/> Don't Care		<input type="checkbox"/> Don't care	
<input type="checkbox"/> A: high Stop	<input type="checkbox"/> J: LED dy27/31	<input type="checkbox"/> A	<input type="checkbox"/> J	<input type="checkbox"/> A	<input type="checkbox"/> J	<input type="checkbox"/> A	<input type="checkbox"/> J	<input type="checkbox"/> A	<input type="checkbox"/> J
<input type="checkbox"/> B: low Stop	<input type="checkbox"/> N: LED fix slow	<input type="checkbox"/> B	<input type="checkbox"/> N	<input type="checkbox"/> B	<input type="checkbox"/> N	<input type="checkbox"/> B	<input type="checkbox"/> N	<input type="checkbox"/> B	<input type="checkbox"/> N
<input type="checkbox"/> C: High Busy	<input type="checkbox"/> R: LED ring slow	<input type="checkbox"/> C	<input type="checkbox"/> R	<input type="checkbox"/> C	<input type="checkbox"/> R	<input type="checkbox"/> C	<input type="checkbox"/> R	<input type="checkbox"/> C	<input type="checkbox"/> R
<input type="checkbox"/> D: low Busy	<input type="checkbox"/> 2: LED fix inverse	<input type="checkbox"/> D	<input type="checkbox"/> 2	<input type="checkbox"/> D	<input type="checkbox"/> 2	<input type="checkbox"/> D	<input type="checkbox"/> 2	<input type="checkbox"/> D	<input type="checkbox"/> 2
<input type="checkbox"/> E: DC high	<input type="checkbox"/> 4: LED ring inverse	<input type="checkbox"/> E	<input type="checkbox"/> 4	<input type="checkbox"/> E	<input type="checkbox"/> 4	<input type="checkbox"/> E	<input type="checkbox"/> 4	<input type="checkbox"/> E	<input type="checkbox"/> 4
<input type="checkbox"/> F: DC low	<input type="checkbox"/> 7: LED on	<input type="checkbox"/> F	<input type="checkbox"/> 7	<input type="checkbox"/> F	<input type="checkbox"/> 7	<input type="checkbox"/> F	<input type="checkbox"/> 7	<input type="checkbox"/> F	<input type="checkbox"/> 7
<input type="checkbox"/> G: LED dy17/31	<input type="checkbox"/> 8: LED off	<input type="checkbox"/> G	<input type="checkbox"/> 8	<input type="checkbox"/> G	<input type="checkbox"/> 8	<input type="checkbox"/> G	<input type="checkbox"/> 8	<input type="checkbox"/> G	<input type="checkbox"/> 8
<input type="checkbox"/> H: LED dy23/31	<input type="checkbox"/> Don't care	<input type="checkbox"/> H	<input type="checkbox"/> Dnc	<input type="checkbox"/> H	<input type="checkbox"/> Dnc	<input type="checkbox"/> H	<input type="checkbox"/> Dnc	<input type="checkbox"/> H	<input type="checkbox"/> Dnc

Signature & date		MVI Sales & Date	
------------------	--	------------------	--

Specifications subject to change without notice, contact your sales representatives for the most recent information.

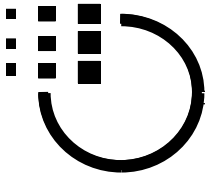

Product Request Form N: (whole chip dependent)

TITLE

*Section Definition : There are ≤ sections defined.

Address	Voice Description	Voice Length	Mute Length	File name	Check Sum
0		s ooh	s ooh		h
1		s ooh	s ooh		h
2		s ooh	s ooh		h
3		s ooh	s ooh		h
4		s ooh	s ooh		h
5		s ooh	s ooh		h
6		s ooh	s ooh		h
7		s ooh	s ooh		h

*Tirgger Option Denfinition: ≤ limit

<input type="checkbox"/> Edge	<input type="checkbox"/> Active high	<input type="checkbox"/> Hold & Irretrigger	<input type="checkbox"/> Unhold & Irretrigger	<input type="checkbox"/> Don't care
<input type="checkbox"/> Level	<input type="checkbox"/> Active low	<input type="checkbox"/> Hold & Retrigger	<input type="checkbox"/> Unhold & Rerigger	

*Trigger Sentence Definition: There are ≤ sentences define

Trigger	Sentence Description (Word section addresses)	Address Count

*Output Definition: Neither variable pitch nor variable loudness is used. Address count summation=

OS		OW	OX	OY	OZ
<input type="checkbox"/> initial High	<input type="checkbox"/> initial Low	<input type="checkbox"/> iH <input type="checkbox"/> iL	<input type="checkbox"/> iH <input type="checkbox"/> iL	<input type="checkbox"/> iH <input type="checkbox"/> iL	<input type="checkbox"/> iH <input type="checkbox"/> iL
<input type="checkbox"/> Don't care		<input type="checkbox"/> Don't care	<input type="checkbox"/> Don't Care	<input type="checkbox"/> Don't Care	<input type="checkbox"/> Don't care
<input type="checkbox"/> A: high Stop	<input type="checkbox"/> J: LED dy27/31	<input type="checkbox"/> A <input type="checkbox"/> J	<input type="checkbox"/> A <input type="checkbox"/> J	<input type="checkbox"/> A <input type="checkbox"/> J	<input type="checkbox"/> A <input type="checkbox"/> J
<input type="checkbox"/> B: low Stop	<input type="checkbox"/> N: LED fix slow	<input type="checkbox"/> B <input type="checkbox"/> N	<input type="checkbox"/> B <input type="checkbox"/> N	<input type="checkbox"/> B <input type="checkbox"/> N	<input type="checkbox"/> B <input type="checkbox"/> N
<input type="checkbox"/> C: High Busy	<input type="checkbox"/> R: LED ring slow	<input type="checkbox"/> C <input type="checkbox"/> R	<input type="checkbox"/> C <input type="checkbox"/> R	<input type="checkbox"/> C <input type="checkbox"/> R	<input type="checkbox"/> C <input type="checkbox"/> R
<input type="checkbox"/> D: low Busy	<input type="checkbox"/> 2: LED fix inverse	<input type="checkbox"/> D <input type="checkbox"/> 2	<input type="checkbox"/> D <input type="checkbox"/> 2	<input type="checkbox"/> D <input type="checkbox"/> 2	<input type="checkbox"/> D <input type="checkbox"/> 2
<input type="checkbox"/> E: DC high	<input type="checkbox"/> 4: LED ring inverse	<input type="checkbox"/> E <input type="checkbox"/> 4	<input type="checkbox"/> E <input type="checkbox"/> 4	<input type="checkbox"/> E <input type="checkbox"/> 4	<input type="checkbox"/> E <input type="checkbox"/> 4
<input type="checkbox"/> F: DC low	<input type="checkbox"/> 7: LED on	<input type="checkbox"/> F <input type="checkbox"/> 7	<input type="checkbox"/> F <input type="checkbox"/> 7	<input type="checkbox"/> F <input type="checkbox"/> 7	<input type="checkbox"/> F <input type="checkbox"/> 7
<input type="checkbox"/> G: LED dy17/31	<input type="checkbox"/> 8: LED off	<input type="checkbox"/> G <input type="checkbox"/> 8	<input type="checkbox"/> G <input type="checkbox"/> 8	<input type="checkbox"/> G <input type="checkbox"/> 8	<input type="checkbox"/> G <input type="checkbox"/> 8
<input type="checkbox"/> H: LED dy23/31	<input type="checkbox"/> Don't care	<input type="checkbox"/> H <input type="checkbox"/> Dnc	<input type="checkbox"/> H <input type="checkbox"/> Dnc	<input type="checkbox"/> H <input type="checkbox"/> Dnc	<input type="checkbox"/> H <input type="checkbox"/> Dnc

Signature & date	<input type="text"/>	MVI Sales & Date	<input type="text"/>
------------------	----------------------	------------------	----------------------

Specifications subject to change without notice, contact your sales representatives for the most recent information.