

TFT COLOR LCD MODULE

NL128102AC28-01A

**46 cm (18.1 inches), 1280 × 1024 pixels,
Full-color, Multi-scan function,
Ultra-wide viewing angle**

DESCRIPTION

NL128102AC28-01A is a TFT (thin film transistor) active matrix color liquid crystal display (LCD) comprising amorphous silicon TFT attached to each signal electrode, a driving circuit, a CRT interface board and a backlight. NL128102AC28-01A has a built-in backlight with an inverter.

The 46 cm (18.1 inches) diagonal display area contains 1280 × 1024 pixels and can display full-color (more than 16 million colors simultaneously). Also, it has ultra wide viewing angle and multi-scan function. Therefore, this module calls Super Fine TFT.

FEATURES

- Ultra-wide viewing angle and low reflection
- High luminance
- CRT interface board
- Auto recognition of input signal
Analog RGB signals, Sync on Green, Synchronous signals (HS, Vsyn, Composite)
- Digital control: e.g. Brightness, Display Position
- Free supply voltage sequence
- Corresponding to DDC1 and DDC2B
- Corresponding to VESA DPMS
- Multi-scan function: e.g. SXGA, XGA, SVGA, VGA, VGA-TEXT, PC-9801, MAC, SUN
- Incorporated edge type backlight (Eight lamps into a lamp unit, Inverter)
- Lamp unit replaceable (Part No.: 181LHS01)
- ILL 1950 3rd ed. C/N/CSA-C22.2 No.950-95
- On Screen Display

Regarding the use of OSD, please note that there is possibility of conflicts with a patent in Europe and the U.S.

Thus, if such conflict might happen when you use OSD, we shall not be responsible for any trouble.

VESA : Video Electronics Standards Association
DPMS : Display Power Management Signaling
DDC1 : Display Data Channel 1
DDC2B: Display Data Channel 2B

APPLICATIONS

- Engineering workstation (EWS), Desk-top type of PC
- Display terminals for control system
- Monitors for process controller

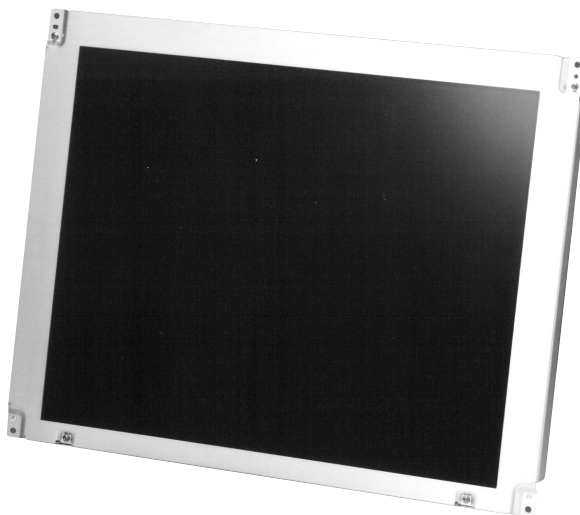

STRUCTURE AND FUNCTIONS

A color TFT (thin film transistor) LCD module is comprised of a TFT liquid crystal panel structure, LSIs for driving the TFT array, and a backlight assembly. The TFT panel structure is created by sandwiching liquid crystal material in the narrow gap between a TFT array glass substrate and a color filter glass substrate. After the driver LSIs are connected to the panel, the backlight assembly is attached to the backside of the panel.

RGB (red, green, blue) data signals from a source system is modulated into a form suitable for active matrix addressing by the onboard signal processor and sent to the driver LSIs which in turn addresses the individual TFT cells.

Acting as an electro-optical switch, each TFT cell regulates light transmission from the backlight assembly when activated by the data source. By regulating the amount of light passing through the array of red, green, and blue dots, color images are created with clarity.

OUTLINE OF CHARACTERISTICS (at room temperature)

Display area	359.04 (H) × 287.232 (V) mm
Drive system	a-Si TFT active matrix
Display colors	Full-color
Number of pixels	1280 × 1024
Pixel arrangement	RGB vertical stripe
Pixel pitch	0.2805 (H) × 0.2805 (V) mm
Module size	424.0 (H) × 337.0 (V) × 39.3 (D) mm (typ.)
Weight	2280 g (typ.)
Contrast ratio	150:1 (typ.)
Viewing angle (more than the contrast ratio of 10:1)	<ul style="list-style-type: none"> • Horizontal: 85° (typ., left side, right side) • Vertical : 85° (typ., up side, down side)
Designed viewing direction	<ul style="list-style-type: none"> • Optimum grayscale ($\gamma = 2.2$): perpendicular
Color gamut	60% (typ., At center, To NTSC)
Response time	45 ms (typ.), "black" to "white"
Luminance	200 cd/m ² (typ.)
Input signals	Analog RGB signals, Synchronous signals (Vsync and Hsync or Composite), Digital data
Backlight	Direct type: Eight cold cathode fluorescent lamps with an inverter <Replacement parts> Inverter Parts No.: 181PW011 Lamp holder set Parts No.: 181LHS01
Supply voltage	12 V, 12 V (Logic/LCD driving, Backlight)
Power consumption	45 W (typ.)

BLOCK DIAGRAM

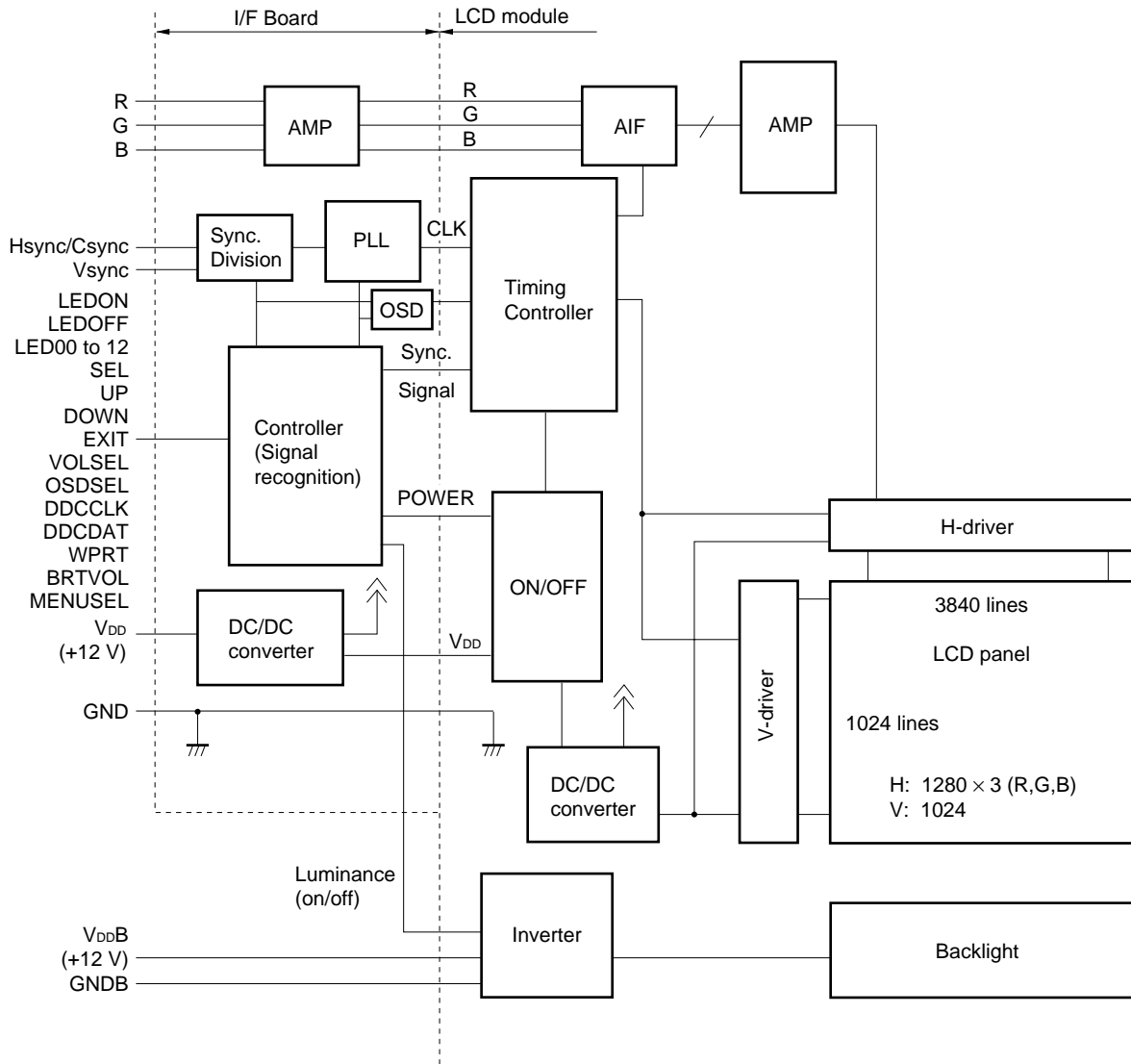

Note Frame Ground and GND are connected in this module.
GNDB is not connected to Frame Ground.

SPECIFICATIONS

GENERAL SPECIFICATIONS

Item	Contents	Unit
Module size	424.0 ± 1.0 (H) × 337.0 ± 1.0 (V) × 40.0 (max.) (D)	mm
Display area	359.04 (H) × 287.232 (V)	mm
Number of dots	1,280 × 3 (H) × 1024 (V)	dots
Pixel pitch	0.2805 (H) × 0.2805 (V)	mm
Dot pitch	0.0935 (H) × 0.2805 (V)	mm
Pixel arrangement	RGB (Red, Green, Blue) vertical stripe	–
Display colors	Full color	color
Weight	2,400 (max.)	g

ABSOLUTE MAXIMUM RATINGS

Parameter	Symbol	Rating	Unit	Remarks
Supply voltage	V _{DD}	–0.3 to + 14	V	T _a = 25°C
	V _{DD} B	–0.3 to + 14	V	
Logic input voltage	V _{In1}	–0.3 to + 5.5	V	T _a = 25°C V _{DD} = 12 V
R,G,B input voltage	V _{In2}	–6.0 to + 6.0	V	
CLK input voltage	V _{In3}	–7.0 to + 7.0	V	
Storage temp.	T _{st}	–20 to + 60	°C	–
Operating temp.	Top	0 to 50	°C	Module surface Note
Humidity (no condensation)	≤ 95% relative humidity		T _a ≤ 40°C	
	≤ 85% relative humidity		40 < T _a ≤ 50°C	
	Absolute humidity shall not exceed T _a = 50°C, 85 % relative humidity) level.		T _a > 50°C	

Note Measured at the LCD panel (Include own fever)

ELECTRICAL CHARACTERISTICS

(1) Logic, LCD driving, Backlight

(T_a = 25°C)

Item	Symbol	Min.	Typ.	Max.	Unit	Remarks
Supply voltage	V _{DD}	11.4	12.0	12.6	V	Logic and LCD driving
	V _{DD} B	11.4	12.0	12.6	V	Backlight
Logic input "L" voltage	V _{IL}	0	–	0.8	V	HS/CS, Vsync, SEL, UP, DOWN, EXIT, VOLSEL, DDCCLK, DDCDAT, OSDSEL, WPRT, MENUSEL
Logic input "H" voltage	V _{IH}	2.2	–	5.25	V	
Logic output "L" voltage	V _{oL1}	–	–	0.4	V	LED00/01/02/10/11/12
Logic output "H" voltage	V _{oH1}	2.4	–	–	V	
Logic input "L" current	I _{IL}	–1	–	–	μA	HS/CS, Vsync
Logic input "H" current	I _{IH}	–	–	1	μA	
Logic output "L" current 1	I _{oL1}	–	–	1	μA	DDCDAT
Logic output "H" current 1	I _{oH1}	–1	–	–	μA	
Supply current	I _{DD}	–	1000 <small>Note1</small>	1500 <small>Note2</small>	mA	VDD = 12.0 V
		–	45 <small>Note1</small>	65 <small>Note2</small>	mA	Power saving mode VDD = 12.0 V
	I _{DD} B	–	2700	3500	mA	VDD B = 12.0 V (Max. luminance)
		–	1	10	mA	Power saving mode VDD B = 12.0 V

- Notes**
1. Checker flag pattern (in EIAJ ED-2522)
 2. Pixel checkered pattern

(2) Video signal (R, G, B) input

(T_a = 25°C)

Item	Min.	Typ.	Max.	Unit	Remarks
Maximum amplitude (white - black)	0 (black)	0.7 (white)	*A	Vp-p	Note
DC input level (black)	–0.5	–	+2.5	V	–
Sync level	0.2	0.3	*B	Vp-p	G terminal (sync on green)
*A + *B	–	–	1.1	Vp-p	–

Note Contrast adjustment is needed if the amplitude exceeds 0.7 Vp-p.

POWER SUPPLY DESIGN

- (1) 12 V for backlight should be started up within 80 ms, otherwise, the protection circuit makes the backlight turns off.
- (2) If the power supply voltage is applied while UP and DOWN are connected to GND, the input control signals become ineffective mode. To reset this mode, turn off the power once and turn on the power while UP and DOWN are connected to GND. Then, the mode will be released.
- (3) Inverter current wave
Inverter current wave is as follows.

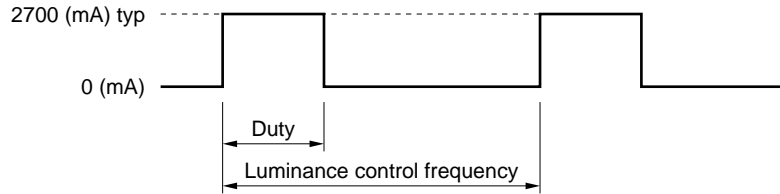

maximum luminance control: 100 %
 minimum luminance control: 20 %
 $\text{Luminance control frequency} \approx \text{Input Vsync frequency} \times K$
 Input Vsync frequency ≤ 75 Hz: $K = 4.6$
 Input Vsync frequency > 75 Hz: $K = 3.6$

- (4) Ripple of supply voltage
Please note that the ripple at the input connector of the module should be within the values shown in this table. If the ripple is beyond these values, the noise may appear on the screen.

	V _{DD} (for logic and LCD driver)	V _{DD} B (for backlight)
Acceptable range	≤ 100 mVp-p	≤ 200 mVp-p

Note The acceptable range of ripple voltage includes spike noise.

Example of the power supply connection

a) Separate the power supply

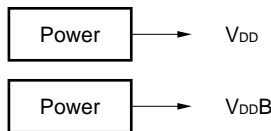

b) Put the filter

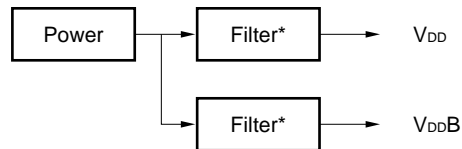

INTERFACE
INTERFACE CONNECTION

(1) CN101

Part No. : MRF03-6R-SMT
 Adaptable socket: MRF03-2 × 6P-1.27 (For cable type) or MRF03-6PR-SMT (For board to board type)
 Supplier : HIROSE ELECTRIC CO., LTD. (coaxial type)

Coaxial cable : UL20537PF75VLAS
 Supplier : HITACHI CO., LTD.

Note A coaxial cable shield should be connected with GND.

Pin No.	Symbol	Pin No.	Symbol
1	B	4	Vsync
2	G	5	HS/CS
3	R	6▼	N.C.

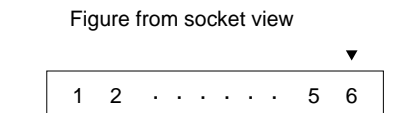

Note N.C. (No connection) should be open.

(2) CN102

Part No. : IL-Z-4PL-SMTY
 Adaptable socket: IL-Z-4S-S125C3
 Supplier : Japan Aviation Electronics Industry Limited (JAE)

Pin No.	Symbol	Pin No.	Symbol
1	DDCCLK	3	MENUSEL
2	DDCDAT	4	GND

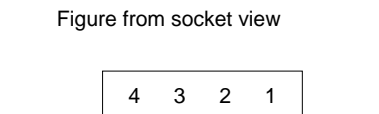

(3) CN103

Part No. : DF14A-25P-1.25H
 Adaptable socket: DF14-25S-1.25C
 Supplier : HIROSE ELECTRIC CO., LTD.

Pin No.	Symbol	Pin No.	Symbol
1	LEDON	14	EXIT
2	LEDOFF	15	GND
3	GND	16	BRTVOL
4	LED00	17	GND
5	LED01	18	VOLSEL
6	LED02	19	OSDSEL
7	LED10	20	WPRT
8	LED11	21	N.C.
9	LED12	22	N.C.
10	GND	23	GND
11	SEL	24	N.C.
12	UP	25	N.C.
13	DOWN		

Figure from socket view

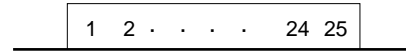

Note N.C. (No connection)

(4) CN104

Part No. : IL-Z-8PL-SMTY
 Adaptable socket: IL-Z-8S-S125C3
 Supplier : Japan Aviation Electronics Industry Limited (JAE)

Pin No.	Symbol	Pin No.	Symbol
1	V _{DD}	5	GND
2	V _{DD}	6	GND
3	V _{DD}	7	GND
4	V _{DD}	8	GND

Figure from socket view

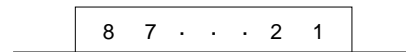

(5) CN201

Part No. : DF3-8P-2H
 Adaptable socket: DF3-8S-2C
 Supplier : HIROSE ELECTRIC CO., LTD.

Pin No.	Symbol	Pin No.	Symbol
1	GNDB	5	V _{DD} B
2	GNDB	6	V _{DD} B
3	GNDB	7	V _{DD} B
4	GNDB	8▼	V _{DD} B

Figure from socket view

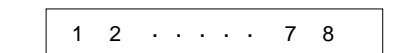

Rear view

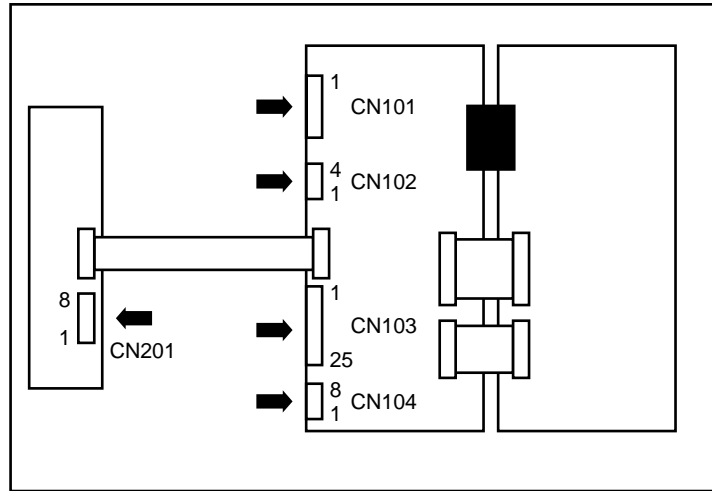

PIN FUNCTION

Symbol	I/O	Logic	Description
HS/CS	Input	Negative	Horizontal synchronous signal input or composite synchronous signal input (TTL level), Positive/Negative auto recognition
Vsync	Input	Negative	Vertical synchronous signal input (TTL level) Positive/Negative auto recognition, Clock input for DDC1
R	Input	–	Red video signal input (0.7 Vp-p, input impedance 75 Ω)
G	Input	–	Green video signal input (0.7 Vp-p, input impedance 75 Ω)
B	Input	–	Blue video signal input (0.7 Vp-p, input impedance 75 Ω)
SEL	Input	Negative	Control function select signal (TTL level) SEL is pulled up in the module. Detail of the functions are mentioned in CONTROL FUNCTIONS . “H” or “open”: SEL off, “L”: SEL on
UP	Input	Negative	Control signal (TTL level) The signal increases the value of the functions selected. UP is pulled up in the module. “H” or “open”: UP off, “L”: UP on
DOWN	Input	Negative	Control signal (TTL level) The signal decreases the value of the functions selected. DOWN is pulled up in the module. “H” or “open”: DOWN off, “L” : DOWN on
EXIT	Input	Negative	Control signal (TTL level) The signal initializes the selected function. EXIT is pulled up in the module. “H” or open”: EXIT off, “L”: EXIT on
OSDSEL	Input	–	Display select signal (TTL level) OSDSEL is pulled up in the module. “H or open”: OSD display off (light on LED) “L”: OSD display on (light off LED) Detail of the functions are mentioned in FUNCTION DISPLAY SELECT
MENUSEL	Input	–	OSD design select signal (TTL level) MENUSEL is pulled up in the module. “H or open”: OSD display No. 2 “L”: OSD display No. 1 (Transparent background) Detail of the functions are mentioned in OSD DESIGN SELECT
BRTVOL	Input	–	Luminance control pin Detail of the functions are mentioned in LUMINANCE CONTROL SELECTION
VOLSEL	Input	–	Luminance control select signal VOLSEL is pulled up in the module. Detail of the functions are mentioned in LUMINANCE CONTROL SELECTION
DDCCLK	Input	Positive	CLK for DDC2B
DDCDAT	Input/ Output	Positive	Data for DDC1/2B read/write
WPRT	Input	Positive	Select signal for DDC “H” or “Open”: Reading mode, “L”: Writing mode
LEDON	Output	Positive	Indicator for LED power on “H”: normal mode select, “L”: Other status

Symbol	I/O	Logic	Description
LEDOFF	Output	Positive	Indicator for power save mode "H": power save mode select, "L": Other status
LED00	Output	Positive	See detail of EQUIVALENT CIRCUIT FOR LED and CONTROL FUNCTIONS
LED01	Output	Positive	
LED02	Output	Positive	
LED10	Output	Negative	
LED11	Output	Negative	
LED12	Output	Negative	
V _{DD}	-	-	
V _{DD} B	-	-	Power supply for backlight. +12 V (±5%) ^{Note2}
GND	-	-	Ground for logic and LCD driving (V _{DD})
GND B	-	-	Ground for backlight power supply (V _{DD} B)

- Notes** 1: Frame Ground (FG) and GND are connected in the module. GND B is not connected in this module.
 2: 12 V for backlight should be started up within 80 ms, otherwise, the protection circuit makes the backlight turns off.

LUMINANCE CONTROL SELECT

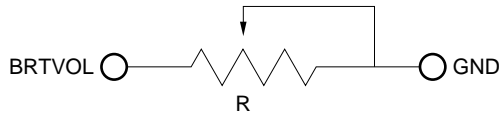
VOLSEL	"L"	"Open"
Form	Digital adjust	Volume adjust
How to adjust	See CONTROL FUNCTIONS	<p>The variable resistor for luminance control should be 10 kΩ type, and zero point of the resistor corresponds to the minimum of luminance.</p>  <p>Maximum luminance (100%): R = 10 KΩ Minimum luminance (30%): R = 0Ω Mating variable resistor: 10 KΩ ±5%, B curve, 1/10 W</p>

Note The status of VOLSEL is valid when the power is switched on.

FUNCTION DISPLAY SELECT

OSDSEL	“L”	“Open”
Form	OSD Display	LED Display
How to adjust	See CONTROL FUNCTIONS	See Example of LED circuit. (Next page)

Note The status of OSDSEL is valid when the power is switched on.

ON SCREEN DISPLAY

Regarding the use of OSD, please note that there is possibility of conflicts with a patent in Europe and the U.S. Thus, if such conflict might happen when you use OSD, we shall not be responsible for any trouble.

OSD DESIGN SELECT

MENUSEL=	“L”	“Open”
Form	OSD display No. 1	OSD display No. 2
How to adjust	See CONTROL FUNCTIONS (OSD background is transparent)	See 7.7 CONTROL FUNCTIONS

Note The status of MENUSEL is valid when the power is switched on.

EQUIVALENT CIRCUIT FOR LED

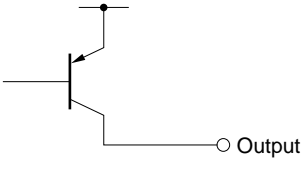
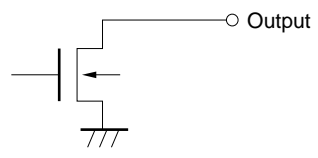
Symbol	I/O	Equivalent circuit
LEDON LEDOFF LED00 LED01 LED02	Output	RN2306 (Toshiba) Or equivalent 
LED10 LED11 LED12	Output	N-ch Open-drain Output 

<Example of LED circuit>

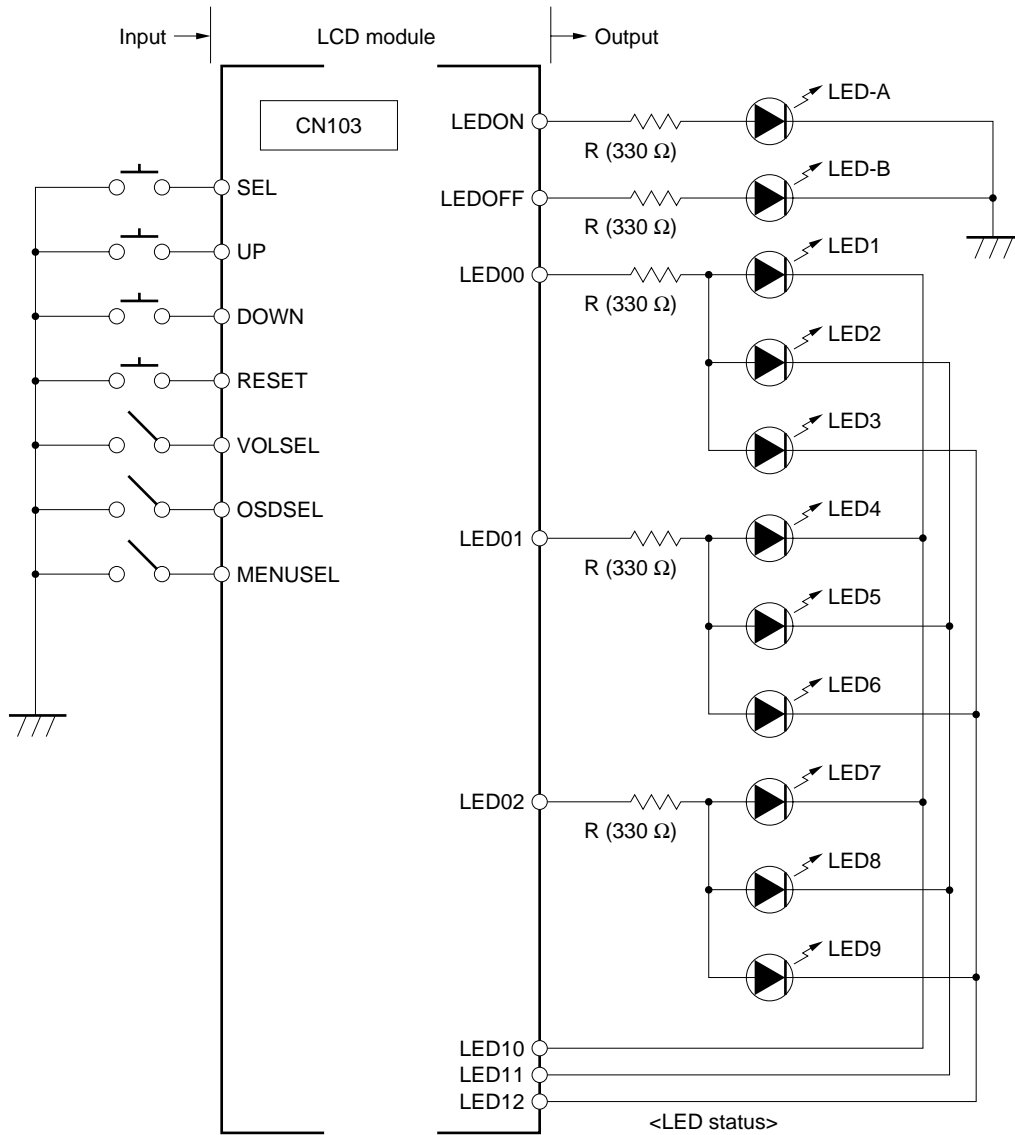

- LED-A: Power on
- LED-B: Power-save mode
- LED1: Luminance
- LED2: Contrast
- LED3: Horizontal display period
- LED4: CLK delay
- LED5: Vertical position
- LED6: Horizontal position
- LED7: Reserve
- LED8: All reset
- LED9: Reserve

INPUT SYNCHRONOUS SIGNAL

This module is corresponding to the synchronous signals below.

Auto recognition mode	Synchronous signal		
	HS/CS	Vsync	Sync. On Green
Separate synchronous signal mode (Hsync, Vsync)	Input	Input	Input or no input
Composite synchronous signal mode	Input (cs)	No input	Input or no input
Sync. On Green mode	No input	No input	Input
Power save mode	No input	No input	No input
	No input	Input	Input or no input
	Input (HS)	No input	Input or no input

Note Power save mode corresponds to VESA DPMA.

CONTROL FUNCTIONS

FUNCTION ITEMS

(1) The function for OSD or LED

1. Luminance : luminance of backlight Control
2. Contrast : white-level of video signal Control
3. Horizontal display period: horizontal display period Adjust
4. CLK delay : CLK-phase Adjust
5. Vertical position : vertical position Adjust
6. Horizontal position : horizontal position Adjust
7. ALL RESET : Reset to factory-default value

(2) The function for OSD

1. Sub Brightness : Brightness with each video signal Control
2. Sub Contrast : white-level with each video signal Control
3. Video signal information: Display multi-scan function, Hsync and Vsync frequency

Each selected value is memorized into LCD memory after SEL signal input or time out. The memorized value are not affected even if the power is turned off. But the selected value is not memorized in case that a selected mode is changed another one before time out or power is turned off before time out.

Regarding the luminance, the luminance value can not be memorized while the variable volume resistor is selected.

This function does not work while the power save mode.

INDICATOR OF THE FUNCTIONS

The selected functions can be indicated either LED or OSD (On Screen Display) by setting OSDSEL signal.

OSDSEL = "H or "OPEN": LED
 OSDSEL = "L" : OSD

LED state show below table. Please see the recommendation circuit diagram.

Selection function	LED00	LED01	LED02	LED10	LED11	LED12
Default (no-select condition)	L	L	L	H	H	H
Luminance	H	L	L	L	H	H
Contrast	H	L	L	H	L	H
Horizontal display period	H	L	L	H	H	L
CLK delay	L	H	L	L	H	H
Vertical position	L	H	L	H	L	H
Horizontal position	L	H	L	H	H	L
Reserve (no-use)	L	L	H	L	H	H
All reset	L	L	H	H	L	H
Reserve (no-use)	L	L	H	H	H	L

SELECTION BY OSD

The following pictures appear on the screen by pushing the SEL key. Adjust the each value in best position by pushing UP and DOWN key.

1) Menu



2) Brightness and Sub Brightness

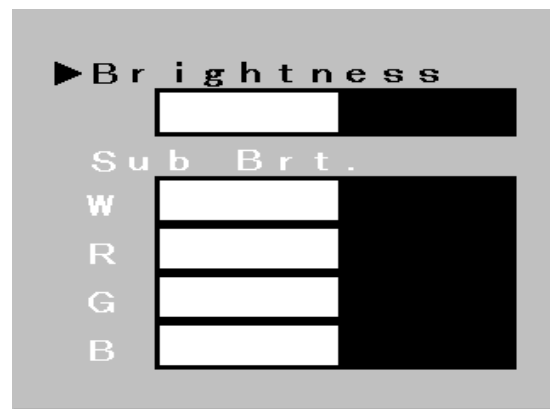

3) Contrast and Sub Contract

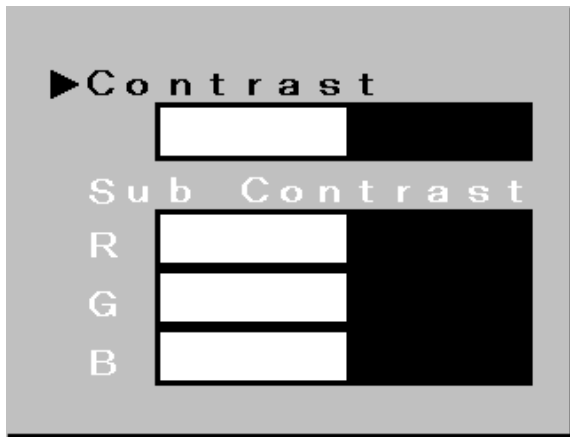

4) Horizontal display period, Clock delay, Vertical display position and Horizontal display position

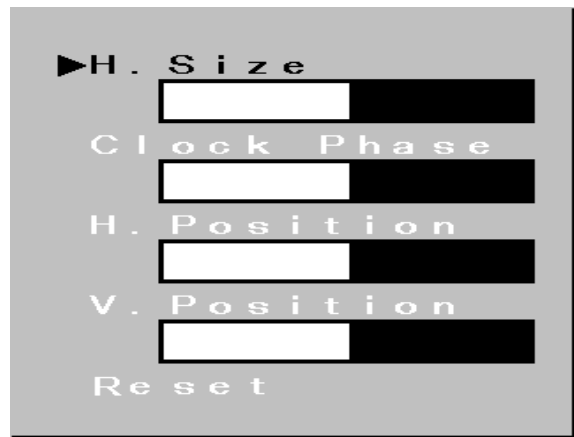

5) Information

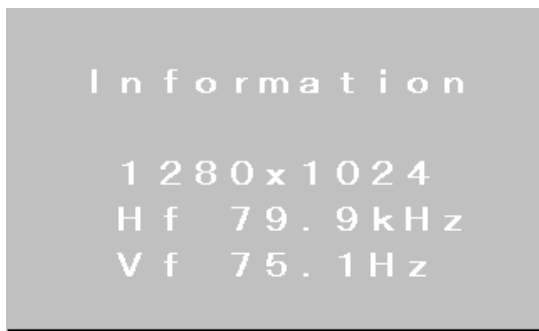

6) All Reset



FLOW CHART OF CONTROL FUNCTIONS FOR SEL, UP, DOWN AND EXIT

<LED display>

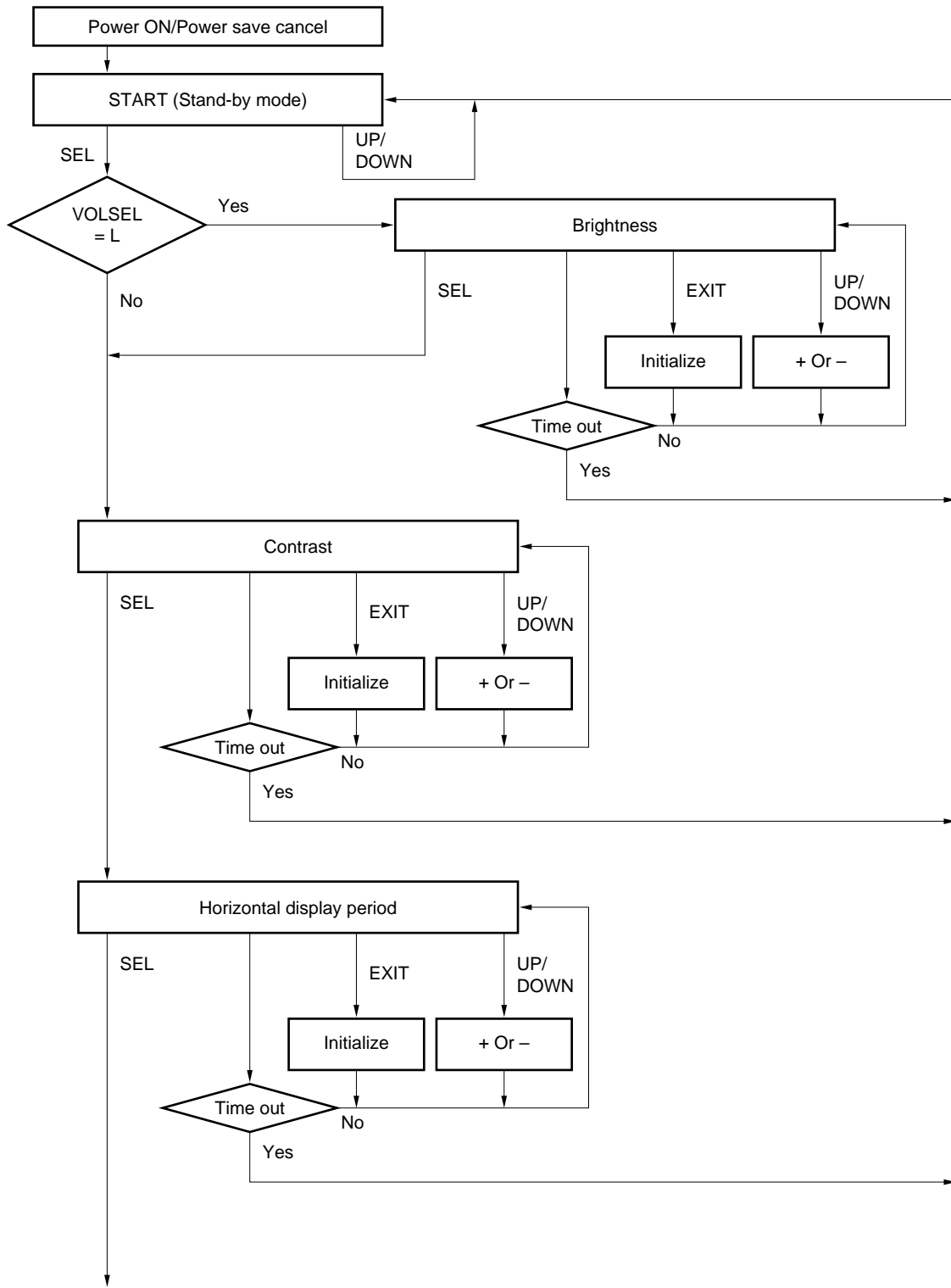

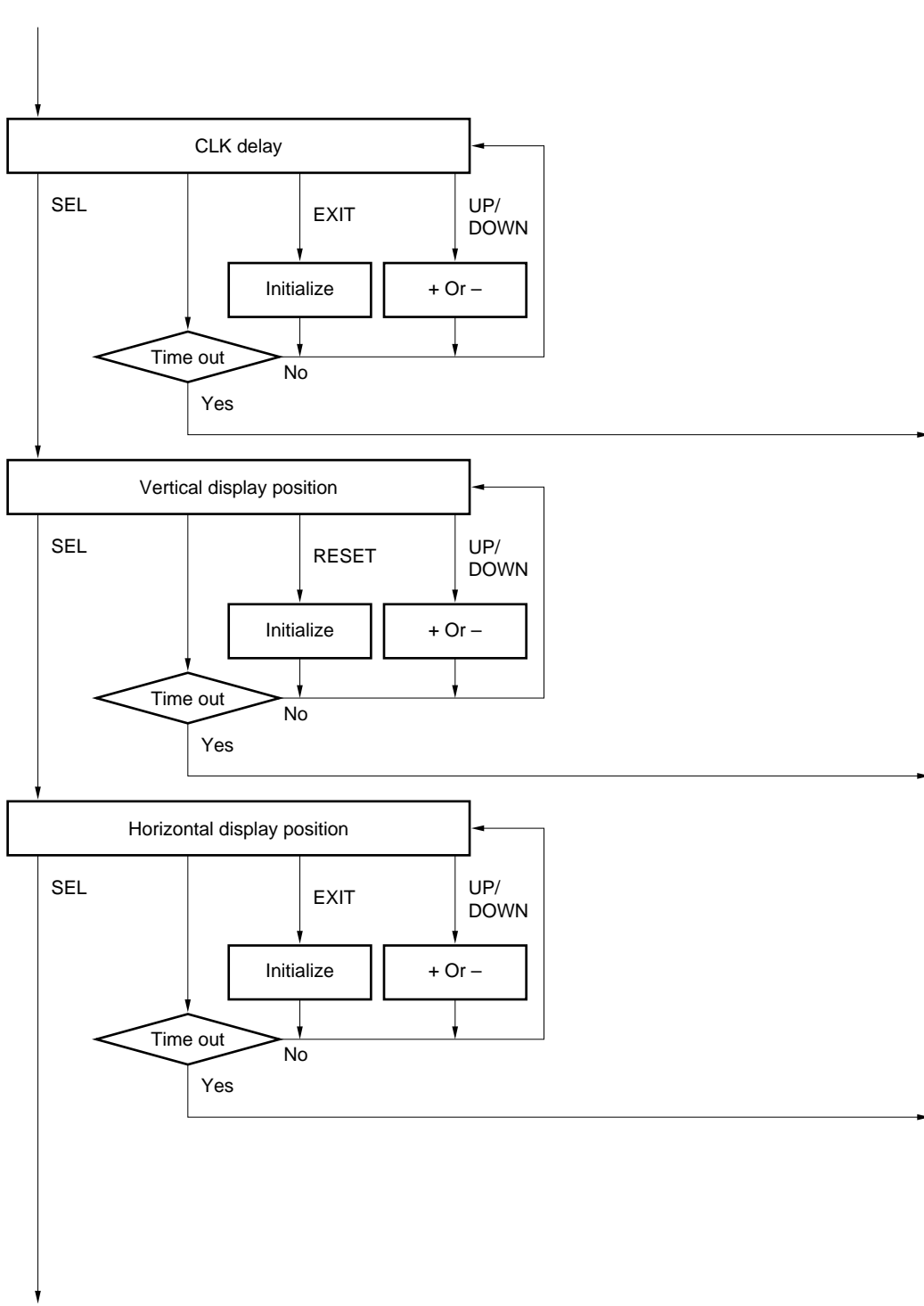

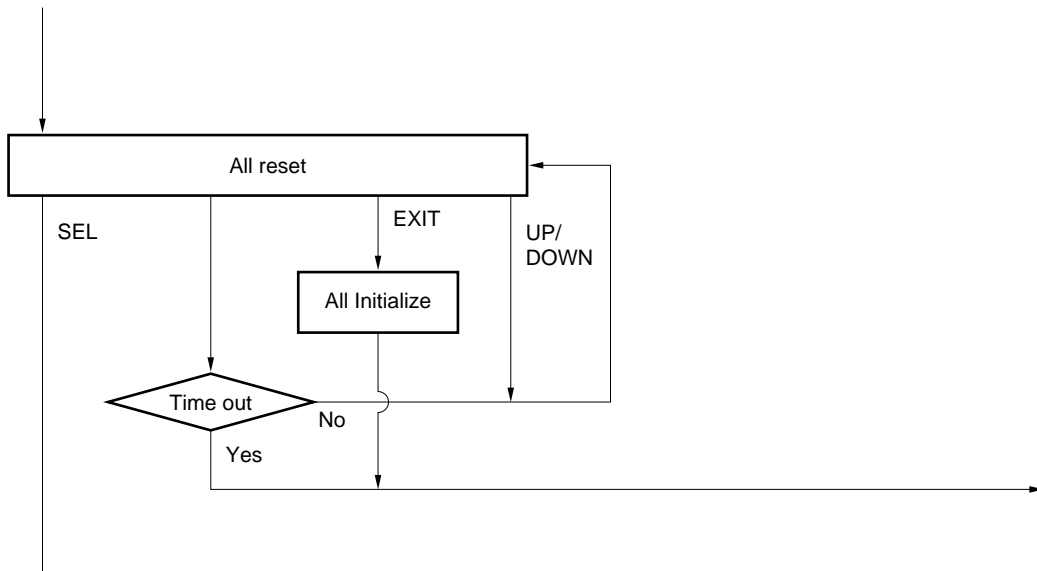

- Notes**
1. The value of the selected signals by UP and DOWN key is continuously incremented if the input signal is held more than approx. one second. If it's less than one second, the value is incremented by one.
 2. RESET signal initializes the value selected by SEL key. All reset function initializes all the values adjusted already. RESET signal should be held more than approx. two seconds.
 3. No key input for more than ten seconds shall be regarded "Time out".

<OSD display>

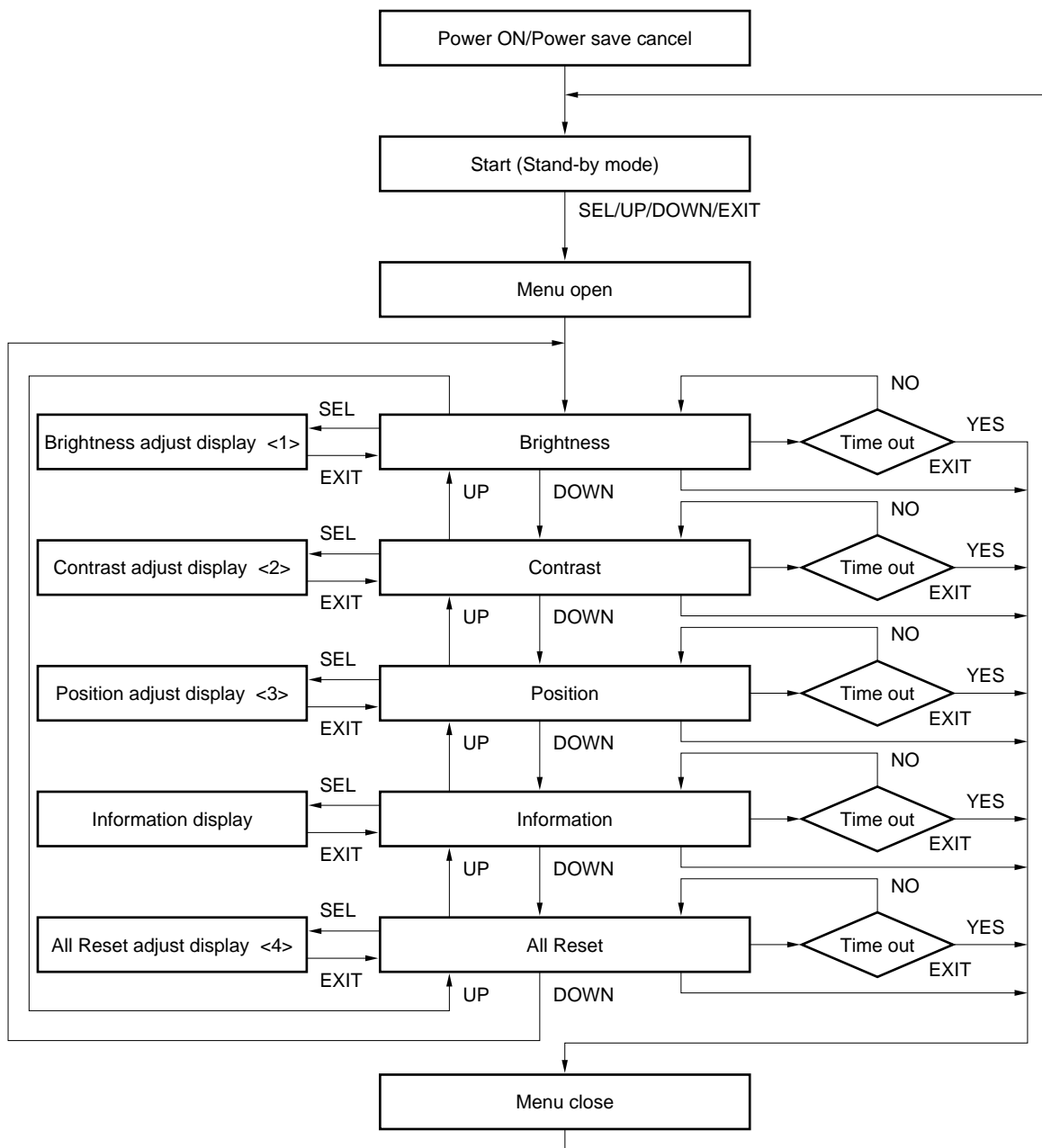

- Notes**
1. The value of the selected signals by UP and DOWN key is continuously incremented if the input signal is held more than approx. one second. If it's less than one second, the value is incremented by one.
 2. EXIT signal initializes the value selected by SEL key. All reset function initializes all the values adjusted already.
 3. No key input for more than ten seconds shall be regarded "Time out".

<1> Brightness adjust display

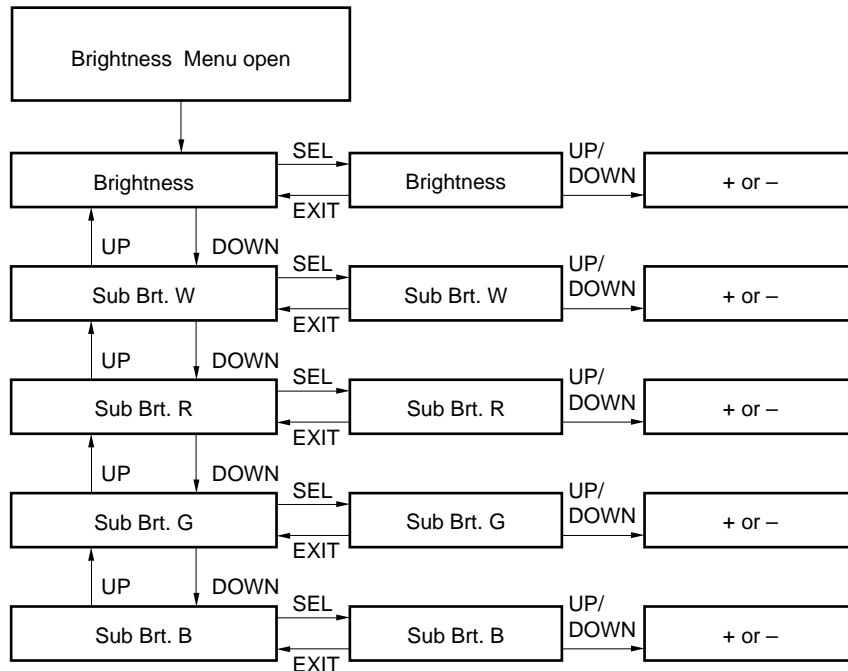

<2> Contrast adjust display

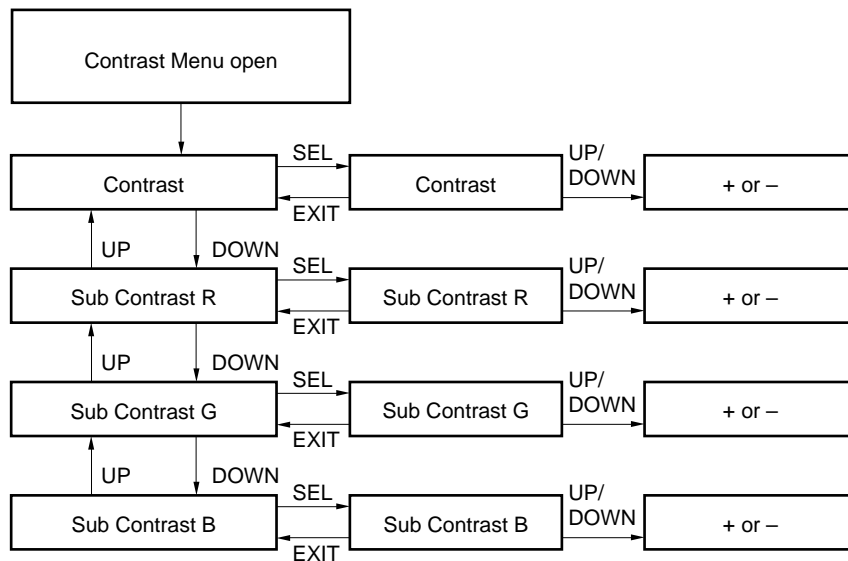

<3> Position adjust display

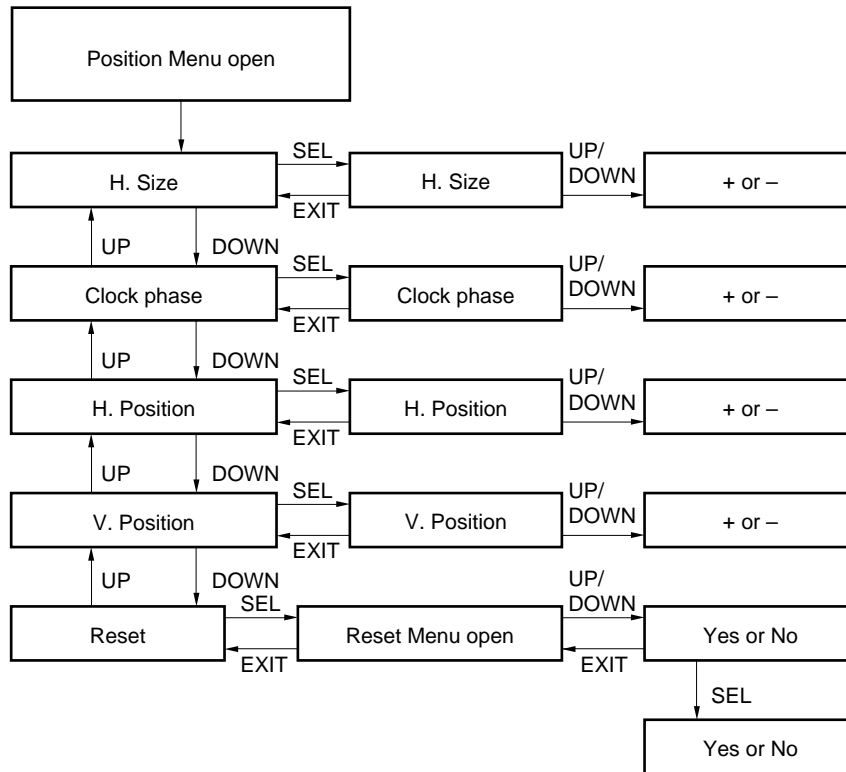

<4> All Reset adjust display

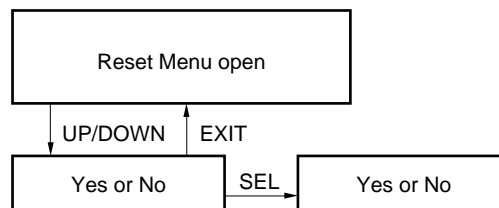

- Remarks 1.** If the UP, DOWN signal is input continuously for 1 sec. or more, each adjustment setting value is sequentially incremented or decremented. If input is 1 sec. or less, each setting value is incremented or decremented by 1. However, only even numbers or multiples of 5 can be set for multiplication value settings.
- 2.** Resetting of each adjustment value initializes only that adjustment value, while initialization using All Reset initializes all adjustment values for modes currently displayed. (Brightness, including contrast, can only be initialized when digital light modulation is selected.)
- 3.** Time-out is approximately 10 sec.

PRESET TIMING

The 20 types of display timing shown below are preset in this module. When the timing signals in this table are input, the device automatically assesses display timing and controls the display using the preset value.

No.	Display resolution (dots)	Vsync (Hz)	Hsync (kHz)	DOTCLK (MHz)	V Pulse (H)	V B.porch (V)	H Pulse (DOTCLK)	H B.porch (DOTCLK)	Sync Logic V, H	Remarks
1	640 × 400	56.432	24.830	21.053	8	25	96	48	-, -	NEC PC98
2	640 × 480	59.992	31.469	25.175	2	33	96	48	-, -	VGA
3	720 × 400	70.087	31.469	28.322	2	35	108	45	+, -	VGA TXT
4	800 × 600	60.317	37.879	40.000	4	23	128	88	+, +	VESA
5	640 × 480	66.667	35.000	30.240	3	39	64	96	SonG type A	Macintosh
6	640 × 480	75.000	37.500	31.500	3	16	64	120	-, -	VESA
7	720 × 400	85.039	37.927	35.500	3	42	36	144	+, -	VESA ^{Note}
8	640 × 480	85.008	43.269	36.000	3	25	48	112	-, -	VESA ^{Note}
9	1024 × 768	60.004	48.363	65.000	6	29	136	160	-, -	VESA
10	800 × 600	75.000	46.875	49.500	3	21	80	160	+, +	VESA
11	832 × 624	74.565	49.735	57.283	3	39	64	224	SonG type A	Macintosh
12	800 × 600	85.061	53.674	56.250	3	27	64	152	+, +	VESA ^{Note}
13	1024 × 768	70.069	56.476	75.000	6	29	136	144	-, -	VESA
14	1024 × 768	75.029	60.023	78.750	3	28	96	176	-, -	VESA
15	1280 × 1024	60.020	63.981	108.000	3	38	112	248	+, +	VESA
16	1152 × 900	66.003	61.846	94.500	4	31	128	208	CS(-)	SUN ^{Note}
17	1024 × 768	77.068	62.040	84.375	4	31	128	176	CS(-)	SUN ^{Note}
18	1280 × 1024	67.189	71.691	117.000	8	33	112	224	CS(-)	SUN
19	1152 × 900	76.149	71.809	108.000	8	33	128	192	CS(-)	SUN ^{Note}
20	1280 × 1024	75.025	79.976	135.000	3	38	144	248	+, +	VESA

* These preset timings are not included in the specifications of the LCD module. Use preset timing only after careful evaluation.

Note 1. Please bear in mind slight adjustment (multiplication value, clock delay, and display location) is required as a result of equipment variation even if input is performed with the display timing of this table.

Readjustment, however, is unnecessary because adjusted values are stored in memory for every preset number.

Display is controlled with preset timing near HS and Vsync frequency even if a signal with a timing other than the preset display timing is input.

2. The device may not function normally if a signal is input that differs from the timing shown in the above table by a large margin. In addition, the device will not operate normally if waveforms are distorted by rounding of Hsync or Vsync waveforms, noise, and others factors, even for a signal with the same timing as shown above.

Example For 640 × 480 dots, HS: 37.861 kHz, and Vsync: 72.809 Hz, the image is displayed with preset number 6. Adjustment may not be synchronized if the expansion rate (scaling factor) or other values differ when the device is used with a display timing other than a preset one. Therefore, only use a non-preset display timing after careful evaluation.

3. Display colors may change during Sync on Green (SonG) input.
4. SonG signal types:

(1) SonG type A

An equivalent Hsync pulse is not present during Vsync period.

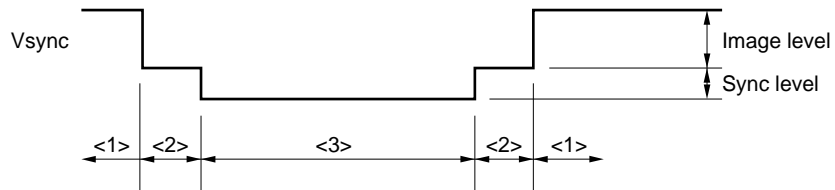

(2) SonG type B

An equivalent Hsync pulse is present during Vsync period.

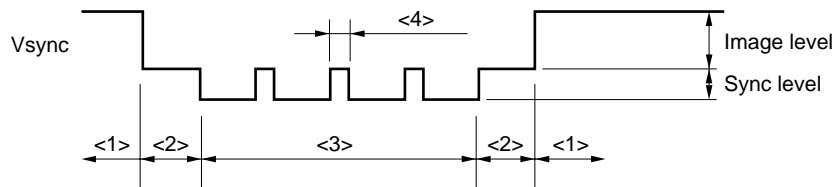

- <1> Image signal
- <2> Black level period
- <3> Vsync period
- <4> Hsync equivalent pulse

DDC FUNCTION

This function is corresponding to VESA DDC™ and EDID™ (Structure Version 1).

- Writing mode : WPRT = “L”
- Reading mode: WPRT = “H” or Open

Please write a data into necessary addresses in advance when you use this function. Data “55H” in address “00H” and “FFH” in other address are already programmed when shipping. The input equivalent circuit diagram is as follow.

EDID: Extended Display Identification Data

<Internal circuit diagram>

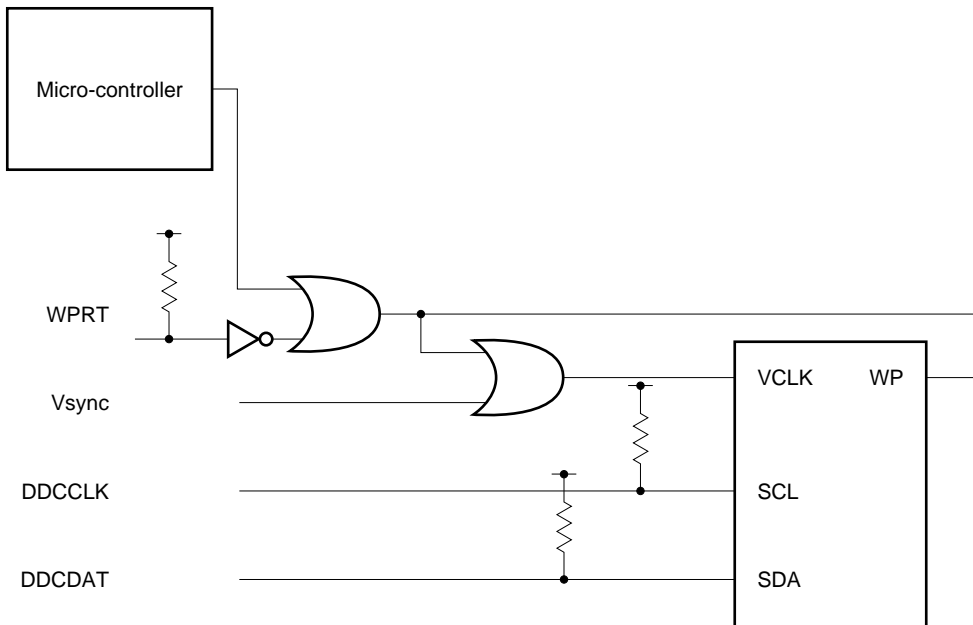

Product: Microchip Technology Inc.
24LCS21
or equipment

DPMS

This function is corresponding to VESA DPMS™ Standard.

VESA DPMS Standard						NL128102AC28-01A	
State	Signal			Power saving	Recovery time	Power saving	Recovery time
	Horizontal	Vertical	Video				
On	Pulses	Pulses	Active	None	Not applicable	None	Not applicable
Stand-by	No pulses	Pulses	Blanked	Minimum	Short	Maximum	Short
Suspend	Pulses	No pulses	Blanked	Substantial	Longer	Maximum	Short
Off	No pulses	No pulses	Blanked	Maximum	System dependent	Maximum	Short

INPUT SIGNAL TIMING

SXGA MODE (STANDARD)

Name		Symbol	Min.	Typ.	Max	Unit	Remark
CLK	Frequency	1/tc	95.0 –	108.0 9.3	135.0 –	MHz ns	SXGA standard
	Rise/Fall	tcrf	–	–	10	ns	–
	Pulse-width	tc/tcl	0.4	0.5	0.6	–	–
Hsync	Period	th	12.3 –	15.630 1688	17.0 –	μs CLK	63.981 kHz (typ.)
	Display	thd	– –	11.852 1280	– –	μs CLK	–
	Front-porch	thf	– –	0.444 48	– –	μs CLK	–
	Pulse-width	thp	– –	1.037 112	– –	μs CLK	–
	Back-porch	thb	1.0 –	2.294 248	– –	μs CLK	Note
	Pulse-width + Back-porch	thbp	1.8	–	–	μs	–
	V-Hsync timing hold/setup time	thvh	4	–	–	ns	–
		thvs	1	–	–	CLK	–
Rise/Fall	thrf	–	–	10	ns	–	
Vsync	Period	tv	13.3 –	16.661 1066	18.5 –	ms H	60.020 Hz (typ.)
	Display	tvd	– –	16.005 1024	– –	ms H	–
	Front-porch	tvf	– 1	0.016 1	– –	ms H	–
	Pulse-width	tvp	– 2	0.047 3	– –	ms H	–
	Back-porch	tvb	– 5	0.594 38	– –	ms H	–

Note Minimum value of Back-porch (thb) must be satisfied.

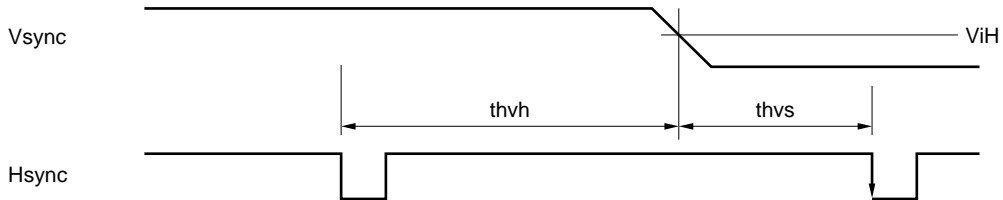
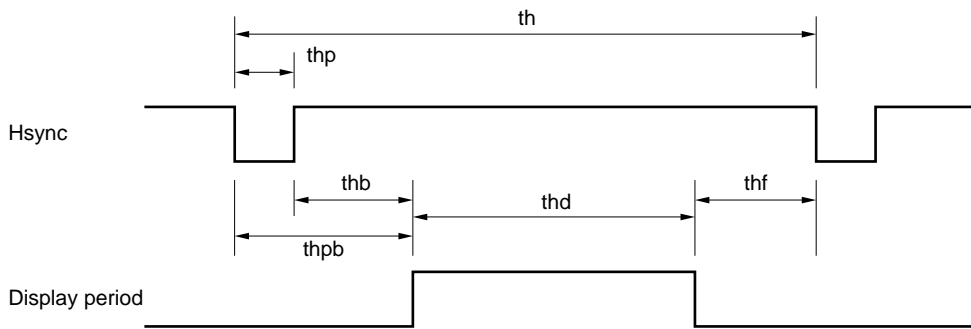
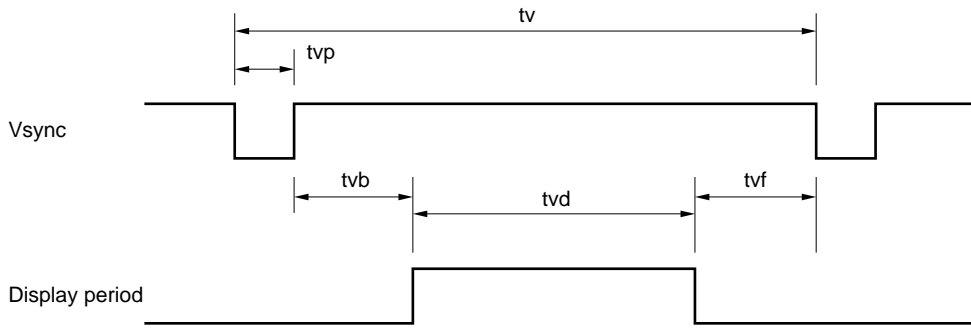

INPUT SIGNAL AND DISPLAY POSITION - SXGA STANDARD TIMING -

Pixels

D (0,0)	D (0,1)	D (0,2)	D (0,1)
D (1,0)	D (1,1)	D (1,2)	D (1,1279)
D (2,0)	D (2,1)	D (2,2)	D (2,1279)
•	•	•			•
•	•	•			•
•	•	•			•
•	•	•			•
D (1023,0)	D (1023,1)	D (1023,2)	D (1023,1279)

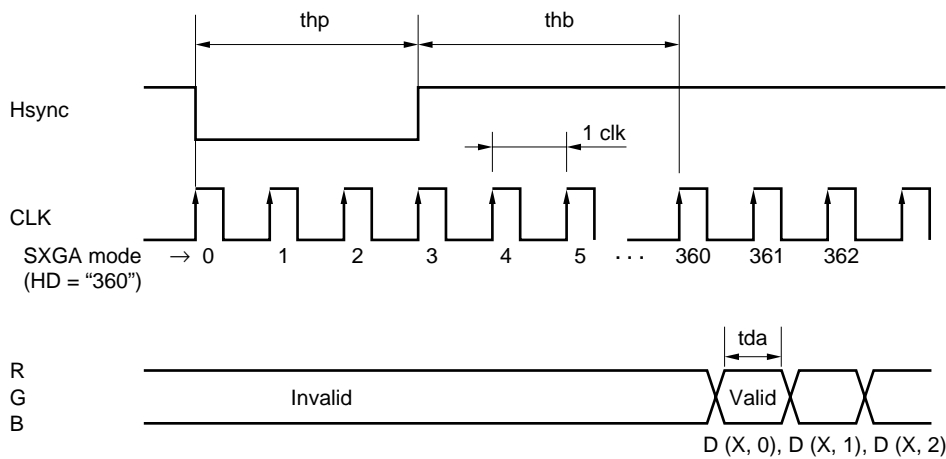
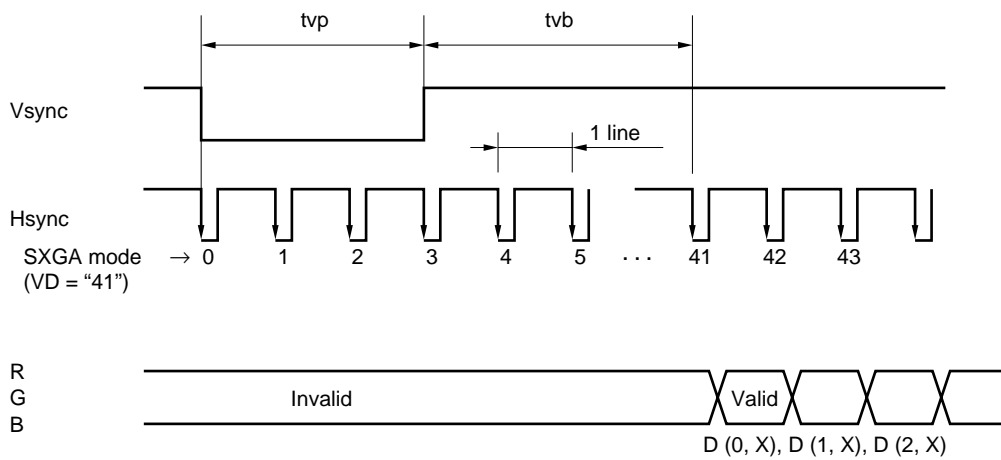

Note The tda should be more than 4ns

EXPANSION FUNCTION (REFERENCE)

HOW TO USE EXPANSION MODES

Expansion mode is a function to expand screen. For example, VGA signal has 640 × 480 pixels. But, if the display data can be expanded to 2.0 times vertically and horizontally, VGA screen image can be displayed fully on the screen of SXGA resolution.

This LCD module has the function that expands vertical direction as shown in Table 1. And expanding horizontal direction is possible by setting input CLK frequency equivalent to the magnification. It is necessary to make this CLK outside of this LCD module.

Please adopt this mode after evaluating display quality, because the appearance in expansion mode is happened to be relatively bad in some cases.

The followings show display magnifications for each mode.

Input display	Number of pixels	Magnification	
		Vertical	Horizontal ^{Note}
SXGA	1280 × 1024	1.0	1.0
XGA	1024 × 768	1.25	1.25
SVGA	800 × 600	1.6	1.6
VGA	640 × 480	2.0	2.0
VGA text	720 × 400	2.5	1.7
PC9801	640 × 400	2.5	2.0
MAC	832 × 624	1.6	1.5

Note The horizontal magnification multiplies the input clock (CLK).

Input CLK = system CLK × horizontal magnification

Example: In case of SXGA and VGA, CLK frequency can be decided as follows.

SXGA: System CLK (108.0 MHz) × 1.0 = 108.0 MHz

VGA : System CLK (25.175 MHz) × 2.0 = 50.35 MHz

SETTING SERIAL DATA FOR EXPANSION

Mode	Input signal							Module serial-data setting		
	System CLK [MHz]	Hsync [kHz]	Vsync [Hz]	Horizontal		Vertical		HSE	HD	VD
				Count Number [CLK]	DSP [CLK]	Count Number [H]	DSP [H]	Calculation formula		
				(A)	(B)	-	(C)	(A) × Ver.magni	(B) × Hor.magni	= (C)
SXGA (1280 × 1024)	108.0	63.981	60.02	1688	360	1066	41	(A) × 1	(B) × 1	= (C)
	117.0	71.691	67.189	1632	336	1067	41			
	125.0	75.120	71.204	1664	352	1055	28			
	130.076	76.968	72.000	1690	378	1069	42			
	135.0	78.125	72.005	1728	384	1085	58			
	135.0	79.976	75.025	1688	392	1066	41			
XGA (1024 × 768)	65*	48.363	60.004	1344	296	806	35	(A) × 1.25	(B) × 1.25	
	75*	56.476	70.069	1328	280	806	35			
	78.75*	60.023	75.029	1312	272	800	31			
MAC (832 × 624)	57.283*	49.725	74.5	1152	288	667	42	(A) × 1.5	(B) × 1.5	
SVGA (800 × 600)	36*	35.156	56.25	1024	200	625	24	(A) × 1.6	(B) × 1.6	
	40*	37.879	60.317	1056	216	628	27			
	50*	48.077	72.188	1040	184	666	29			
	49.5*	46.875	75	1056	240	666	24			
VGA (640 × 480)	25.175*	31.469	59.94	800	144	525	35	(A) × 2.0	(B) × 2.0	
	31.5*	37.861	72.809	832	168	520	31			
	31.5*	37.5	75	840	184	500	19			
	30.24*	35.0	66.667	864	160	525	42			
VGA text (720 × 400)	28.322*	31.469	70.087	900	153	449	37	(A) × 1.7	(B) × 1.7	
PC9801 (640 × 400)	21.053*	24.827	56.432	848	144	440	33	(A) × 2.0	(B) × 2.0	

*: Standard timings (Please set them up properly for correct expansion).

- Notes**
1. DSP = Display Start Period, DSP is total of "pulse-width" and "back-porch".
 2. HD and VD are approximate value. Set HD and VD in case of adjusting display to the screen center.
 3. The pulse-width of Hsync, Vsync and Back-porch are the same as SXGA-mode (Standard-mode).

DISPLAY IMAGE

1) XGA mode (1024 × 768)

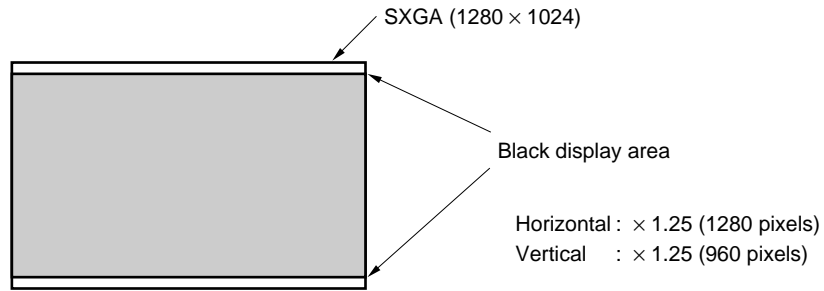

2) SVGA mode (800 × 600)

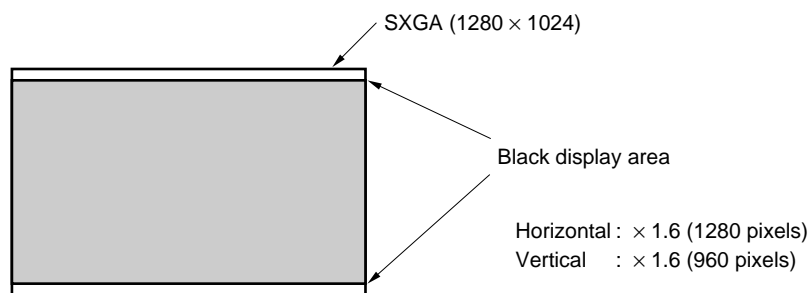

3) VGA mode (640 × 480)

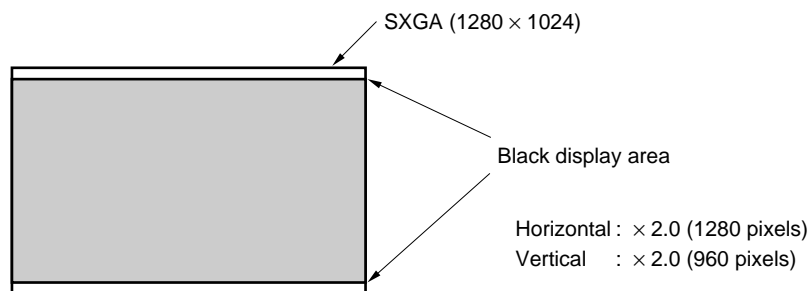

4) PC9801 mode (640 × 400)

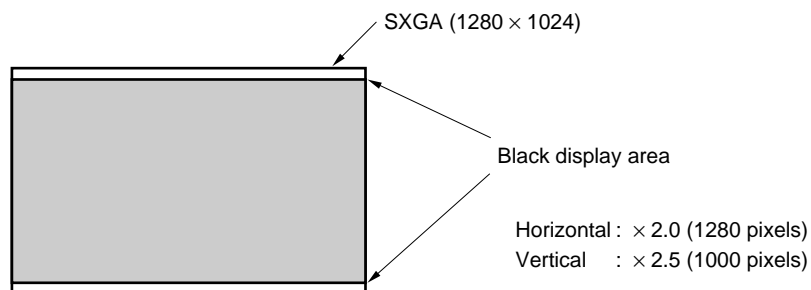

5) VGA text mode (720 × 400)

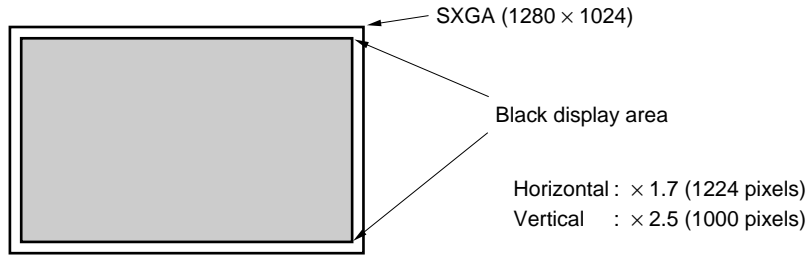

6) 832 × 624 MAC mode (832 × 624)

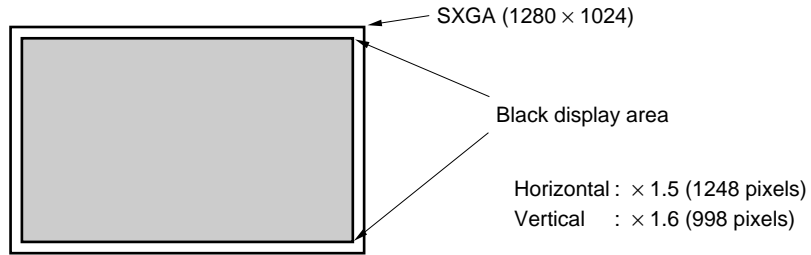

OPTICAL CHARACTERISTICS

(Ta = 25°C, VDD = 12 V, VDDb = 12 V)

Item	Symbol	Condition	Min.	Typ.	Max.	Unit	Remark
Contrast ratio	CR	$\theta R = 0^\circ, \theta L = 0^\circ, \theta D = 0^\circ$, White/Black, at center	100	150	–	–	Note 1
Luminance	Lvmax	White, at center	150	200	–	cd/m ²	Note 2
Luminance uniformity	–	White	–	–	1.30	–	Note 3
Color gamut	C	$\theta R = 0^\circ, \theta L = 0^\circ, \theta U = 0^\circ, \theta D = 0^\circ$ at center, to NTSC	50	60	–	%	–
Response time	Ton	Black to White	–	45	70	ms	Note 5
	Toff	White to Black	–	35	60		

Reference data

(Ta = 25°C, VDD = 12 V, VDDb = 12 V)

Item	Symbol	Condition	Min.	Typ.	Max.	Unit	Remark
Viewing angle range	θR	CR > 10, $\theta U = 0^\circ, \theta D = 0^\circ$ White/Black, at center	70	85	–	deg.	Note 4
	θL		70	85	–	deg.	
	θU	CR > 10, $\theta R = 0^\circ, \theta L = 0^\circ$ White/Black, at center	70	85	–	deg.	
	θD		70	85	–	deg.	
Luminance control range	–	Maximum luminance: 100%	–	30 – 100	–	%	–

Notes 1. The contrast ratio is calculated by using the following formula.

$$\text{Contrast ratio (CR)} = \frac{\text{Luminance with all pixels in "white"}}{\text{Luminance with all pixels in "black"}}$$

2. The luminance is measured after 20 minutes from the module works, with all pixels in “white”. The typical value is measured after luminance saturation, more than one hour after burn-in. The timing is SXGA standard mode, preset timing No. 20. See detail **PRESET TIMING**.

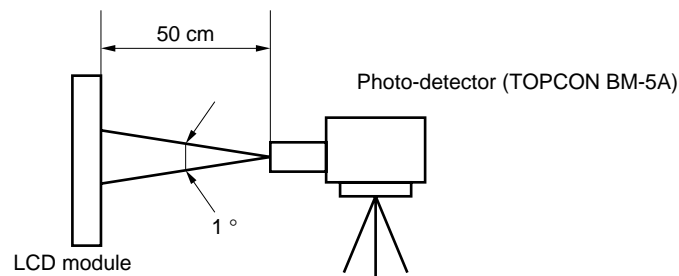

3. Luminance uniformity is calculated by using the following formula.

$$\text{Luminance uniformity} = \frac{\text{Maximum luminance}}{\text{Minimum luminance}}$$

The luminance is measured at near the five points shown below.

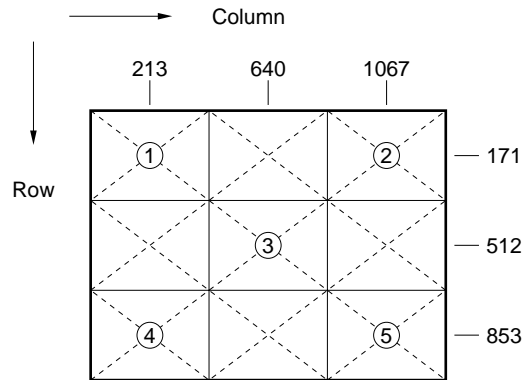

4. Definitions of viewing angle are as follows.

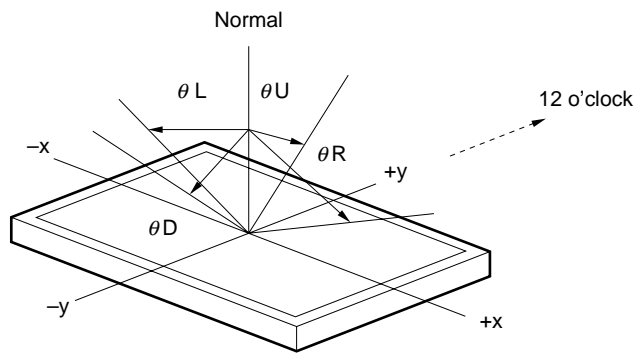

5. Definitions of response time is as follows.

Photo-detector output signal is measured when the luminance changes "white" to "black" or "black" to "white".

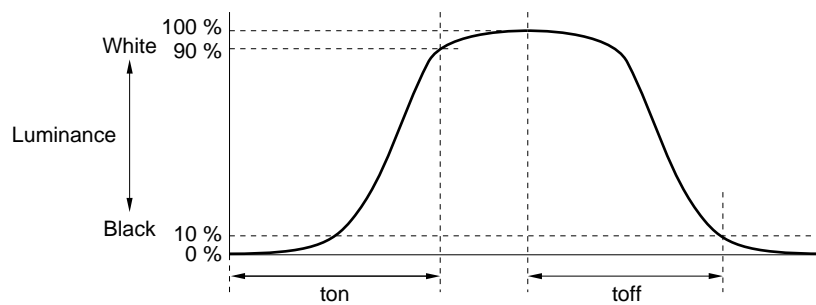

RELIABILITY TEST

Test item	Test condition	Judgment
High temperature/humidity operation	50 ±2°C, 85% relative humidity 240 hours, Display data is white.	Note 1
Heat cycle (operation)	<1> 0°C ±3°C ... 1 hour 55°C ±3°C ... 1 hour <2> 50 cycles, 4 hours/cycle <3> Display data is white.	Note 1
Thermal shock (non-operation)	<1> -20°C ±3°C ... 30 minutes 60°C ±3°C ... 30 minutes <2> 100 cycles <3> Temperature transition time is within 5 minutes.	Note 1
Vibration (non-operation)	<1> 5-100 Hz, 1.2 G 1 minute/cycle, X, Y, Z direction <2> 10 times each direction	Notes 1, 2
Mechanical shock (non-operation)	<1> 30 G, 11 ms X, Y, Z direction <2> 3 times each direction	Notes 1, 2
ESD (operation)	150 pF, 150 Ω, ±10 KV 9 places on a panel 10 times each place at one-second intervals	Note 1 Note 3
Dust (operation)	15 kinds of dust (JIS-Z 8901) Hourly 15 seconds stir, 8 times repeat	Note 1

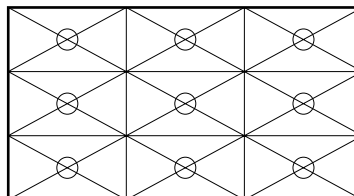

- Notes**
1. Display function is checked by the same condition as LCD module out-going inspection.
 2. Physical damage.
 3. Discharge points are shown in the figure.



GENERAL CAUTIONS

Because next figures and sentences are very important, please understand these contents as follows.

	CAUTION	This figure is a mark that you will get hurt and/or the module will have damages when you make a mistake to operate.
---	----------------	--

	This figure is a mark that you will get an electric shock when you make a mistake to operate.	
	This figure is a mark that you will get hurt when you make a mistake to operate.	

 **CAUTION**

	Do not touch an inverter -- on which is stuck a caution label -- while the LCD module is under the operation, because of dangerous high voltage.
---	--

- (1) Caution when taking out the module a Pick the pouch only, in taking out module from a carrier box.
- (2) Cautions for handling the module
 - a) As the electrostatic discharges may break the LCD module, handle the LCD module with care against electrostaic discharges.
 - b)  As the LCD panel and backlight element are made from fragile glass material, impulse and pressure to the LCD module should be avoided.
 - c) As the surface of polarizer is very soft and easily scratched, use a soft dry cloth without chemicals for cleaning.
 - d) Do not pull the interface connectors in or out while the LCD module is operating.
 - e) Put the module display side down on a horizontal plane.
 - f) Handle connectors and cables with care.
 - g) When the module is operating, do not lose CLK, HS or Vsync signal. If any one of these signals is lost, the LCD panel would be damaged.
 - h) The torque to mounting screw should never exceed 0.392 N·m (4 kgf·cm).
 - i) Don't push or rub the surface of LCD module please.
If you do the scratches or the marks like rubbing may left on the surface of the module.
- (3) Cautions for the atmosphere
 - a) Dew drop atmosphere should be avoided.
 - b) Do not store and/or operate the LCD module in a high temperature and/or high humidity atmosphere. Storage in an anti-static pouch and under the room temperature atmosphere is recommended.
 - c) This module uses cold cathod fluorescent lamps. Therefore, the life of lamps becomes short if the module is operated under the low temperature environment.
 - d) Do not operate the LCD module in a high magnetic field.
- (4) Caution for the module characteristics
 - a) Do not apply the fixed pattern for a long time to the LCD module. It may cause image sticking. Please use the screen savers if the display pattern is fixed for a long time.
 - b) This module has the retardation film which may cause the variation of the color hue in the different viewing angles. The ununiformity may appear on the screen under the high temperature operation.
 - c) The light vertical stripe may be observed depending on the display pattern. This is not defects or malfunctions.

d) The noise from the inverter circuit may be observed in the luminance control mode. This is not defects or malfunctions.

(5) Other cautions

- a) Do not disassemble and/or reassemble LCD module.
- b) Do not readjust any variable resistors or switches in the module.
- c) When returning the module for repair or etc., please pack the module properly to avoid any damages. We recommend using the original shipping packages.
- d) In case that the scan converter is used to convert VGA signal to NTSC, it is recommended using the frame-memory type, not the line-memory.

Liquid Crystal Display has the following specific characteristics. There are not defects nor malfunctions.

The optical characteristics of this module may be affected by the ambient temperature.

This module has cold cathode tube for backlight. Optical characteristics, like luminance or uniformity, will be changed by the progress in time.

Uneven brightness and/or small spots may be observed depending on different display patterns.

OUTLINE DRAWINGS

Front View (Unit in mm)

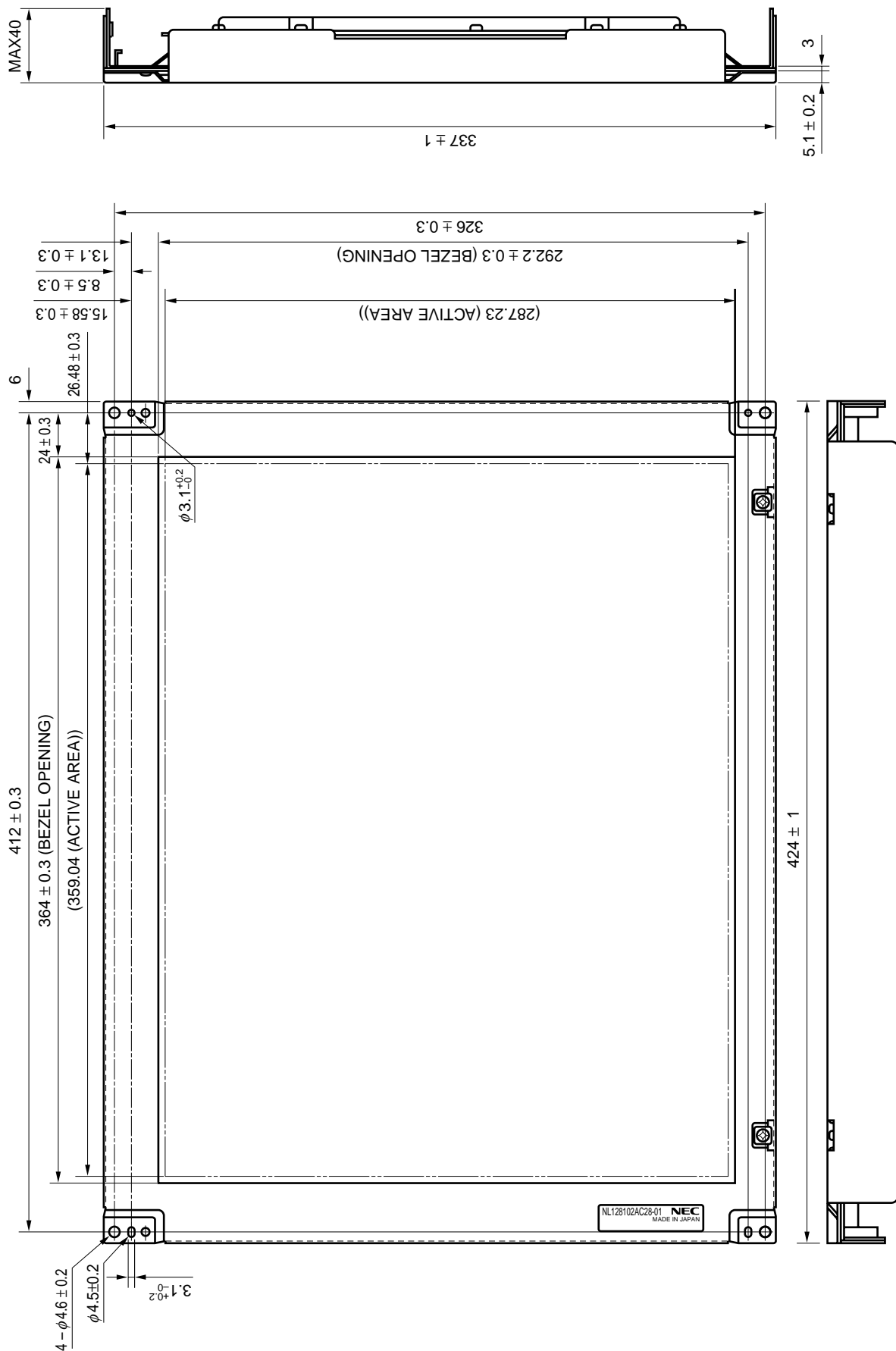

The torque to mounting screw should never exceed 0.392N · m (4 kg · cm).
The tolerance of the dimensions that are not shown is ±0.5 mm.

Rear View (Unit in mm)

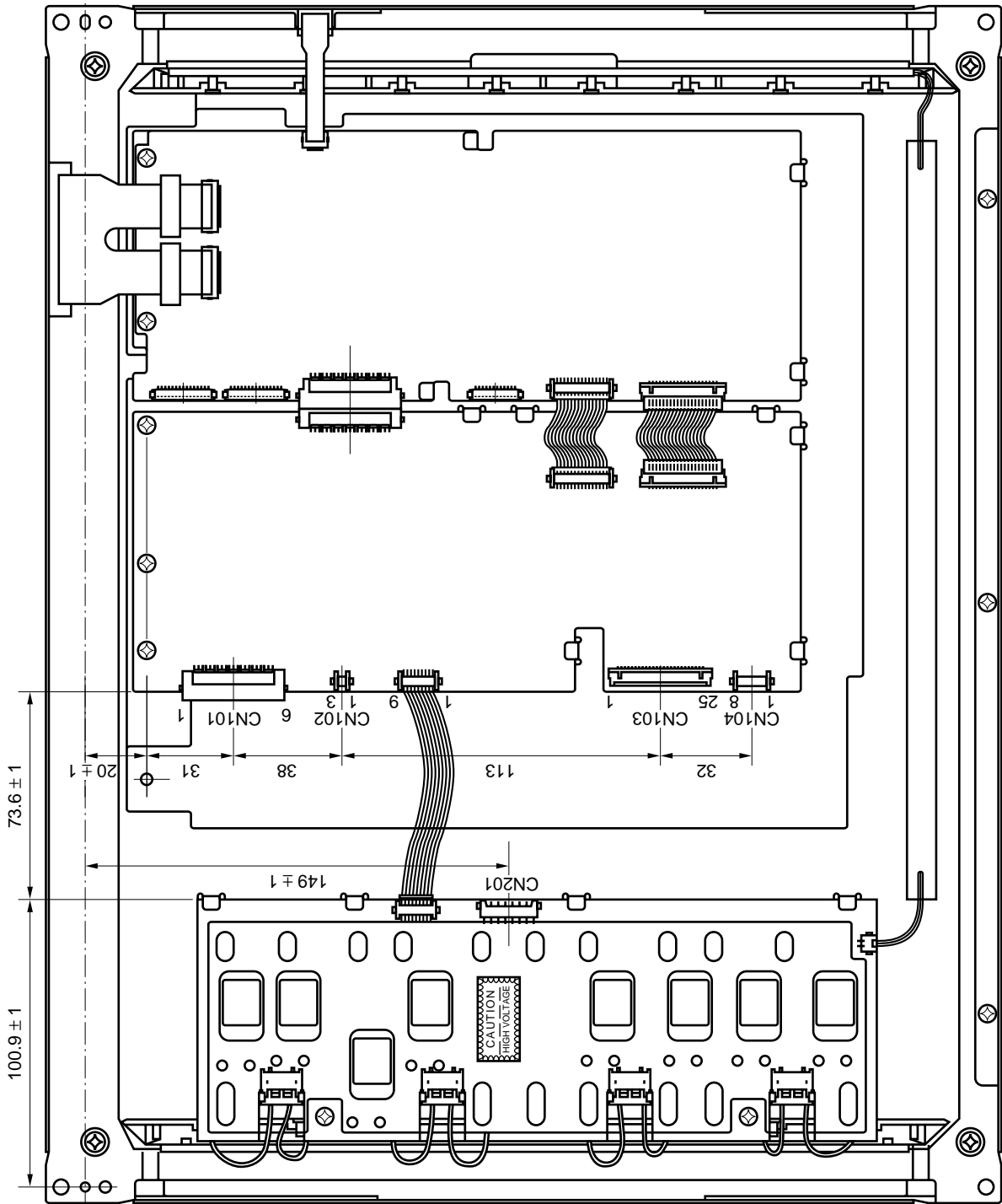
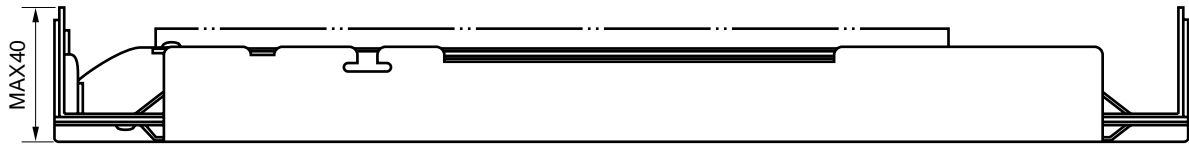

. The tolerance of the dimensions that are not shown is ±0.5 mm.

No part of this document may be copied or reproduced in any form or by any means without the prior written consent of NEC Corporation. NEC Corporation assumes no responsibility for any errors which may appear in this document.

NEC Corporation does not assume any liability for infringement of patents, copyrights or other intellectual property rights of third parties by or arising from use of a device described herein or any other liability arising from use of such device. No license, either express, implied or otherwise, is granted under any patents, copyrights or other intellectual property rights of NEC Corporation or others.

While NEC Corporation has been making continuous effort to enhance the reliability of its electronic components, the possibility of defects cannot be eliminated entirely. To minimize risks of damage or injury to persons or property arising from a defect in an NEC electronic component, customers must incorporate sufficient safety measures in its design, such as redundancy, fire-containment, and anti-failure features.

NEC devices are classified into the following three quality grades:

"Standard", "Special", and "Specific". The Specific quality grade applies only to devices developed based on a customer designated "quality assurance program" for a specific application. The recommended applications of a device depend on its quality grade, as indicated below. Customers must check the quality grade of each device before using it in a particular application.

Standard: Computers, office equipment, communications equipment, test and measurement equipment, audio and visual equipment, home electronic appliances, machine tools, personal electronic equipment and industrial robots

Special: Transportation equipment (automobiles, trains, ships, etc.), traffic control systems, anti-disaster systems, anti-crime systems, safety equipment and medical equipment (not specifically designed for life support)

Specific: Aircrafts, aerospace equipment, submersible repeaters, nuclear reactor control systems, life support systems or medical equipment for life support, etc.

The quality grade of NEC devices is "Standard" unless otherwise specified in NEC's Data Sheets or Data Books. If customers intend to use NEC devices for applications other than those specified for Standard quality grade, they should contact an NEC sales representative in advance.

Anti-radioactive design is not implemented in this product.