

# UTC MPSA13 NPN EPITAXIAL SILICON TRANSISTOR

## DARLINGTON TRANSISTOR

### DESCRIPTION

The UTC MPSA13 is a Darlington transistor.

### FEATURES

- \*Collector-Emitter Voltage:  $V_{CES} = 30V$
- \*Collector Dissipation:  $P_c (mas) = 625 mW$

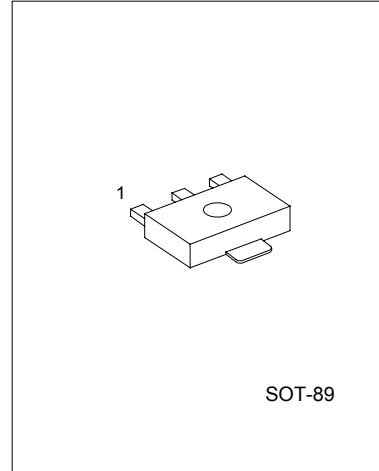

1: EMITTER 2: COLLECTOR 3: BASE

### ABSOLUTE MAXIMUM RATINGS ( $T_a=25^{\circ}C$ )

PARAMETER	SYMBOL	VALUE	UNIT
Collector-Base Voltage	$V_{CBO}$	30	V
Collector-Emitter Voltage	$V_{CES}$	30	V
Emitter-Base Voltage	$V_{EBO}$	10	V
Collector Dissipation	$P_c$	625	mW
Collector Current	$I_c$	500	mA
Junction Temperature	$T_j$	150	$^{\circ}C$
Storage Temperature	$T_{STG}$	-55 ~ +150	$^{\circ}C$

### ELECTRICAL CHARACTERISTICS ( $T_a=25^{\circ}C$ , unless otherwise specified)

PARAMETER	SYMBOL	TEST CONDITIONS	MIN	MAX	UNIT
Collector-Emitter Breakdown Voltage	$BV_{CES}$	$I_c=100\mu A, I_B=0$	30		V
Collector Cut-Off Current	$I_{CBO}$	$V_{CB}=30V, I_E=0$		100	nA
Emitter Cut-Off Current	$I_{EBO}$	$V_{EB}=10V, I_c=0$		100	nA
DC Current Gain	$h_{FE}$	$V_{CE}=5V, I_c=100mA$	10000		
Collector-Emitter Saturation Voltage	$V_{CE(sat)}$	$I_c=100mA, I_B=0.1mA$		1.5	V
Base-Emitter on Voltage	$V_{BE(on)}$	$V_{CE}=5V, I_c=100mA$		2.0	V
Current Gain Bandwidth Product	$f_T$	$V_{CE}=5V, I_c=10mA, f=100MHz$	125		MHz

Pulse test: Pulse Width<300 $\mu s$ , Duty Cycle=2%

# UTC MPSA13 NPN EPITAXIAL SILICON TRANSISTOR

## TYPICAL CHARACTERISTICS

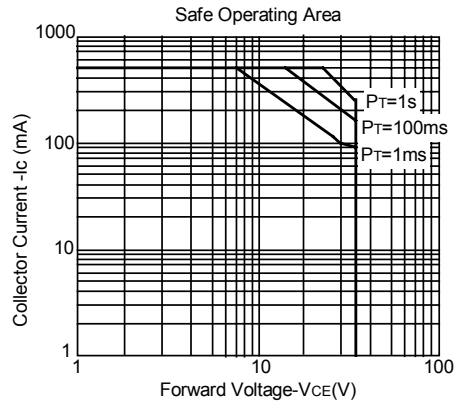
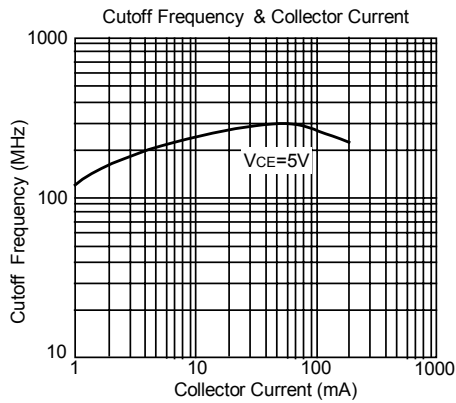
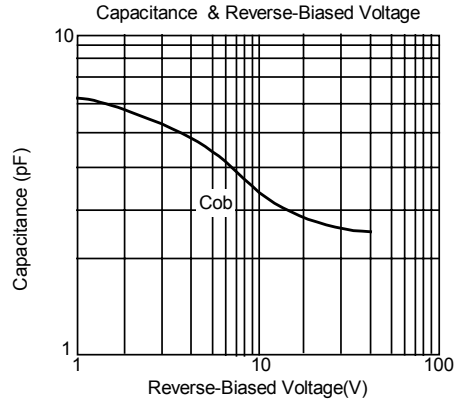
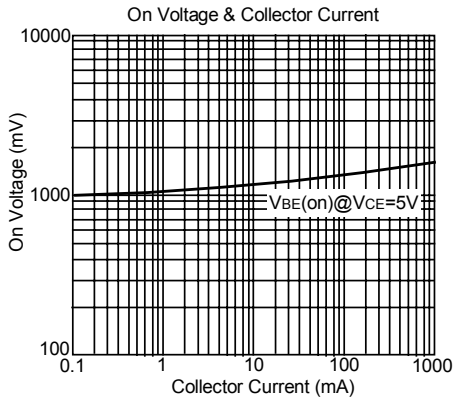
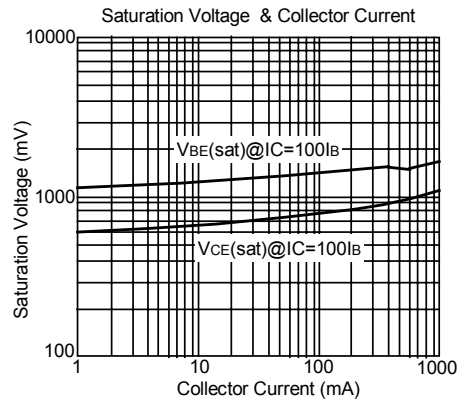
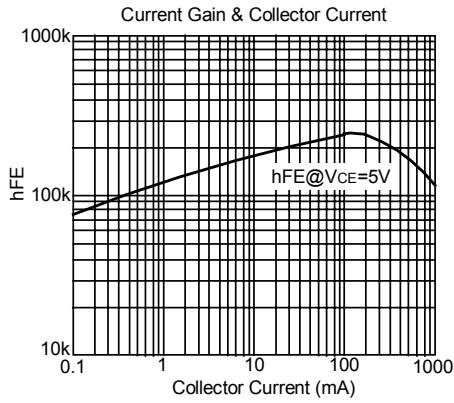

# UTC MPSA13 NPN EPITAXIAL SILICON TRANSISTOR

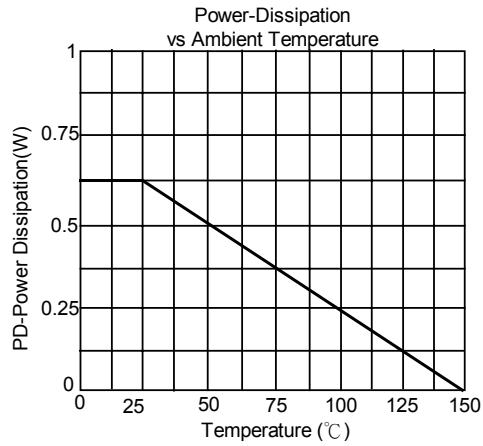

UTC assumes no responsibility for equipment failures that result from using products at values that exceed, even momentarily, rated values (such as maximum ratings, operating condition ranges, or other parameters) listed in products specifications of any and all UTC products described or contained herein. UTC products are not designed for use in life support appliances, devices or systems where malfunction of these products can be reasonably expected to result in personal injury. Reproduction in whole or in part is prohibited without the prior written consent of the copyright owner. The information presented in this document does not form part of any quotation or contract, is believed to be accurate and reliable and may be changed without notice.