



2SA1740

PNP SILICON TRANSISTOR

HIGH VOLTAGE DRIVER APPLICATION

■ FEATURES

*High breakdown voltage.

*Excellent h_{FE} linearity.

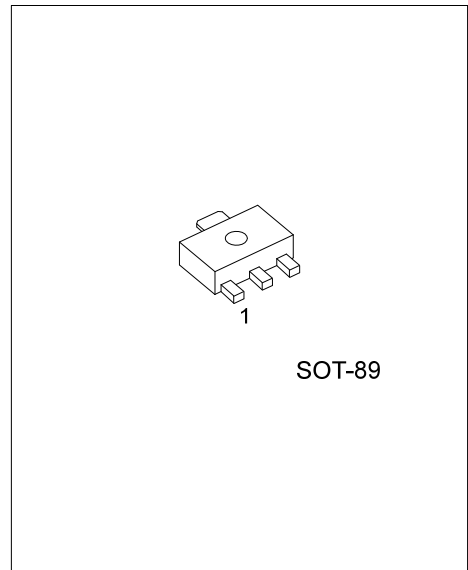

Lead-free: 2SA1740L
Halogen-free: 2SA1740G

■ ORDERING INFORMATION

Ordering Number			Package	Pin Assignment			Packing
Normal	Lead Free Plating	Halogen Free		1	2	3	
2SA1740-x-AB3-R	2SA1740L-x-AB3-R	2SA1740G-x-AB3-R	SOT-89	B	C	E	Tape Reel

<p>2SA1740L-x-AB3-R</p> <p>(1) Packing Type (2) Package Type (3) Rank (4) Lead Plating</p>	<p>(1) R: Tape Reel (2) AB3: SOT-89 (3) x: refer to Classification of h_{FE} (4) G: Halogen Free, L: Lead Free, Blank: Pb/Sn</p>
--	---

■ ABSOLUTE MAXIMUM RATINGS (Ta=25°C , unless otherwise specified)

PARAMETER	SYMBOL	RATINGS	UNIT
Collector-Base Voltage	V_{CBO}	-400	V
Collector-Emitter Voltage	V_{CEO}	-400	V
Emitter-Base Voltage	V_{EBO}	-5	V
Collector Current	I_C	-200	mA
Collector Current (PULSE)	I_{CP}	-400	mA
Collector Power Dissipation	P_C	0.5	W
Junction Temperature	T_J	+150	°C
Storage Temperature	T_{STG}	-55 ~ +150	°C

Note: Absolute maximum ratings are those values beyond which the device could be permanently damaged.

Absolute maximum ratings are stress ratings only and functional device operation is not implied.

■ ELECTRICAL CHARACTERISTICS (Ta=25°C, unless otherwise specified)

PARAMETER	SYMBOL	TEST CONDITIONS	MIN	TYP	MAX	UNIT
Collect-Base Breakdown Voltage	BV_{CBO}	$I_C = -10\mu A, I_E = 0$	-400			V
Collect-Emitter Breakdown Voltage	BV_{CEO}	$I_C = -1mA, I_B = 0, R_{BE} = \infty$	-400			V
Emitter-Base Breakdown Voltage	BV_{EBO}	$I_E = -10\mu A, I_C = 0$	-5			V
Collector Cutoff Current	I_{CBO}	$V_{CB} = -300V, I_E = 0$			-0.1	μA
Emitter Cutoff Current	I_{EBO}	$V_{EB} = -4V, I_C = 0$			-0.1	μA
DC Current Gain	h_{FE}	$V_{CE} = -10V, I_C = -50mA$	60		200	
Collect-Emitter Saturation Voltage	$V_{CE(SAT)}$	$I_C = -50mA, I_B = -5mA$		-0.8		V
Base-Emitter Saturation Voltage	$V_{BE(SAT)}$	$I_C = -50mA, I_B = -5mA$			-1.0	V
Output Capacitance	C_{OB}	$V_{CB} = -30V, f = 1MHz$		5		pF
Reverse Transfer Capacitance	C_{RE}	$V_{CB} = -30V, f = 1MHz$		4		pF
Gain-Bandwidth Product	f_T	$V_{CE} = -30V, I_C = -10mA$		70		MHz
Turn-On Time	t_{ON}	See test circuit		0.25		μs
Turn-Off Time	t_{OFF}	See test circuit		5.0		μs

■ CLASSIFICATION OF h_{FE}

RANK	D	E
RANGE	60-120	100-200

■ TEST CIRCUIT

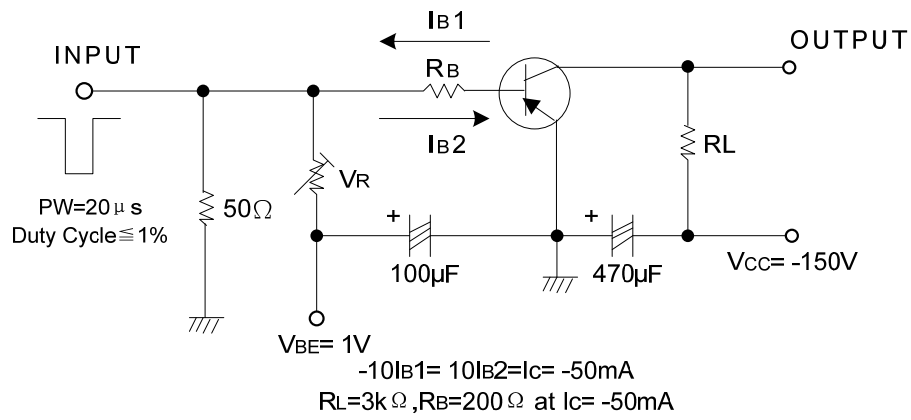

TYPICAL CHARACTERISTICS

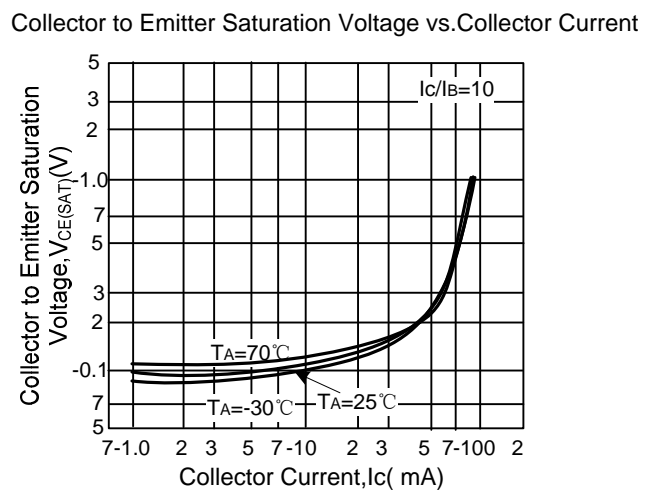
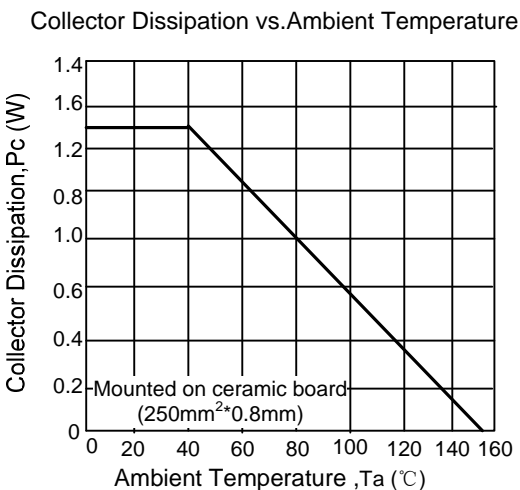
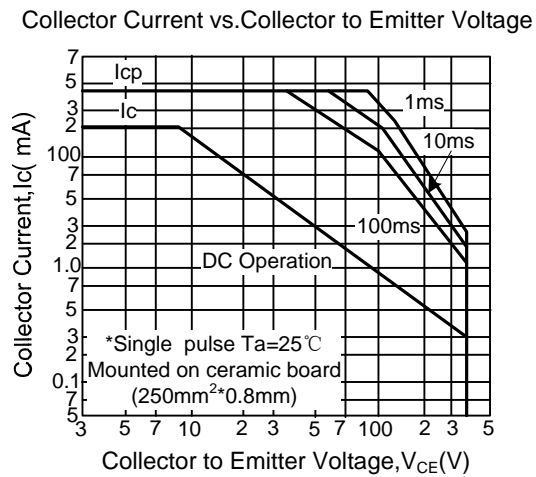
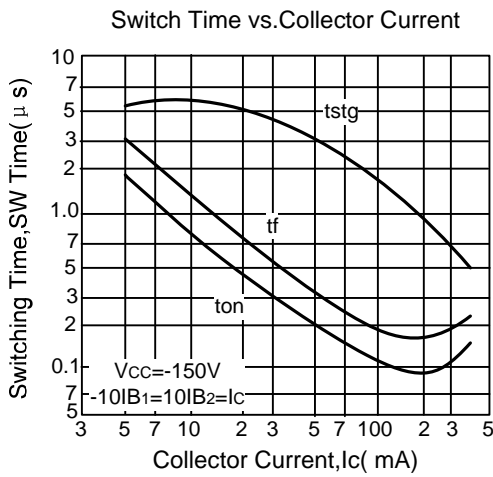
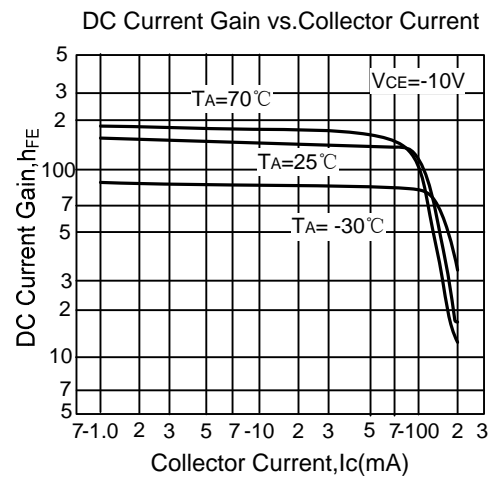
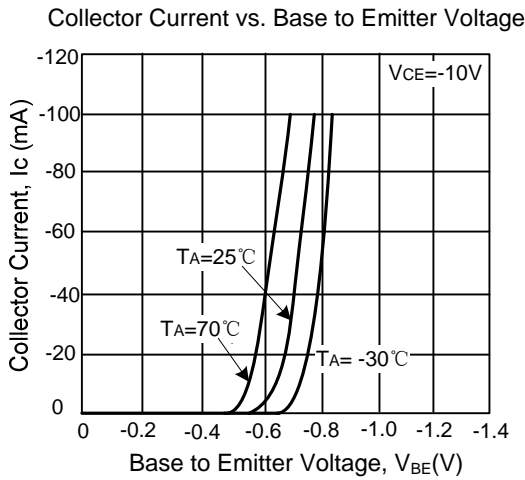

■ TYPICAL CHARACTERISTICS(Cont.)

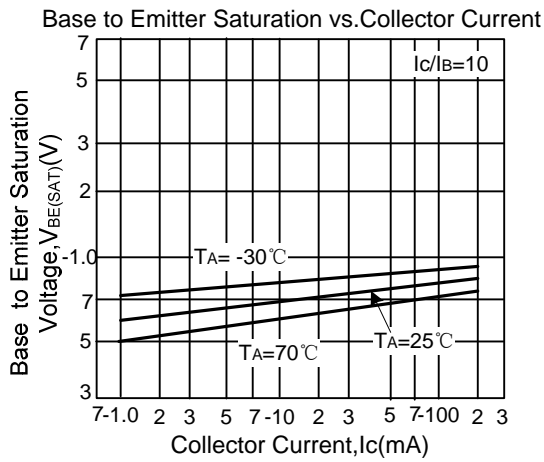

UTC assumes no responsibility for equipment failures that result from using products at values that exceed, even momentarily, rated values (such as maximum ratings, operating condition ranges, or other parameters) listed in products specifications of any and all UTC products described or contained herein. UTC products are not designed for use in life support appliances, devices or systems where malfunction of these products can be reasonably expected to result in personal injury. Reproduction in whole or in part is prohibited without the prior written consent of the copyright owner. The information presented in this document does not form part of any quotation or contract, is believed to be accurate and reliable and may be changed without notice.