

RoHS Compliant Product

A suffix of "-C" specifies halogen & lead-free

Features

MAXIMUM RATINGS* $T_A=25^\circ\text{C}$ unless otherwise noted

Symbol	Parameter	Value	Units
V_{CBO}	Collector-Base Voltage	40	V
V_{CEO}	Collector-Emitter Voltage	30	V
V_{EBO}	Emitter-Base Voltage	6	V
I_C	Collector Current –Continuous	3	A
P_C	Collector Dissipation	1.25	W
P_D	Total Device Dissipation	1.25	W
T_J, T_{stg}	Junction and Storage Temperature	-55-150	$^\circ\text{C}$

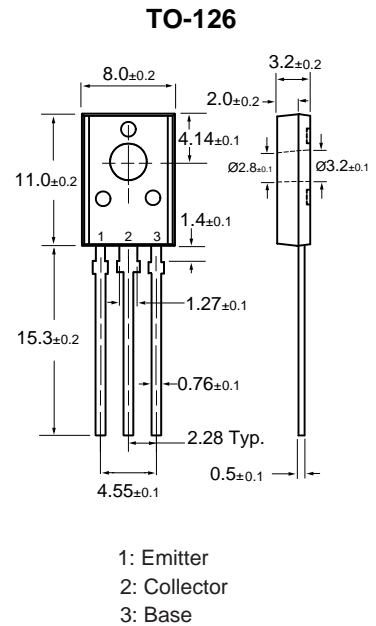

Dimensions in Millimeters

*These ratings are limiting values above which the serviceability of any semiconductor device may be impaired.

ELECTRICAL CHARACTERISTICS($T_{amb}=25^\circ\text{C}$ unless otherwise specified)

Parameter	Symbol	Test conditions	MIN	TYP	MAX	UNIT
Collector-base breakdown voltage	$V(BR)_{CBO}$	$I_C=100\mu\text{A}, I_E=0$	40			V
Collector-emitter breakdown voltage	$V(BR)_{CEO}$	$I_C=10\text{ mA}, I_B=0$	30			V
Emitter-base breakdown voltage	$V(BR)_{EBO}$	$I_E=100\text{ mA}, I_C=0$	6			V
Collector cut-off current	I_{CBO}	$V_{CB}=40\text{ V}, I_E=0$			1	μA
Collector cut-off current	I_{CEO}	$V_{CE}=30\text{ V}, I_B=0$			10	μA
Emitter cut-off current	I_{EBO}	$V_{EB}=6\text{ V}, I_C=0$			1	μA
DC current gain	$h_{FE(1)}$	$V_{CE}=2\text{ V}, I_C=1\text{ A}$	60		400	
	$h_{FE(2)}$	$V_{CE}=2\text{ V}, I_C=100\text{ mA}$	32			
Collector-emitter saturation voltage	$V_{CE(sat)}$	$I_C=2\text{ A}, I_B=0.2\text{ A}$			0.5	V
Base-emitter saturation voltage	$V_{BE(sat)}$	$I_C=2\text{ A}, I_B=0.2\text{ A}$			1.5	V
Transition frequency	f_T	$V_{CE}=5\text{ V}, I_C=0.1\text{ mA}$ $f=10\text{ MHz}$	50			MHz

CLASSIFICATION OF $h_{FE(1)}$

Rank	R	O	Y	GR
Range	60-120	100-200	160-320	200-400

Typical Characteristics

D882

TOTAL POWER DISSIPATION vs. AMBIENT TEMPERATURE

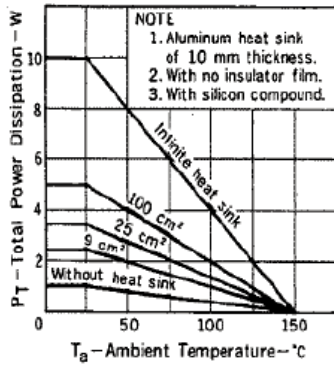

DERATING CURVES FOR ALL TYPES

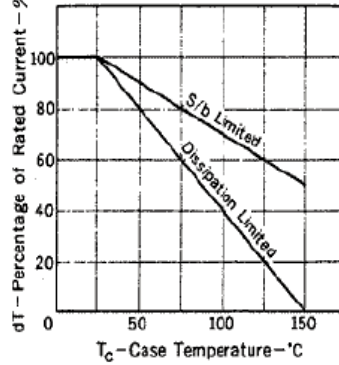

THERMAL RESISTANCE vs. PULSE WIDTH

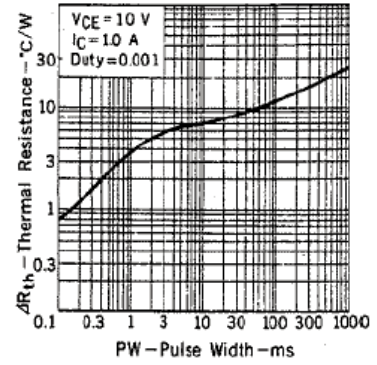

SAFE OPERATING AREAS

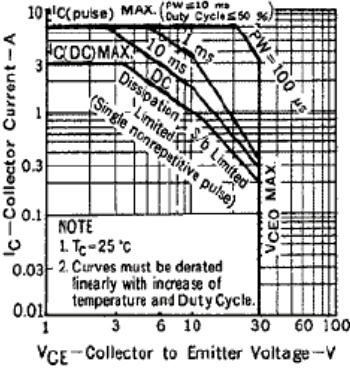

COLLECTOR CURRENT vs. COLLECTOR TO EMITTER VOLTAGE

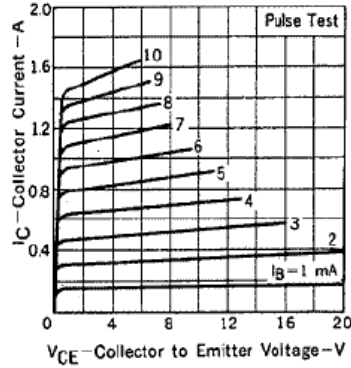

DC CURRENT GAIN, BASE TO EMITTER VOLTAGE vs. COLLECTOR CURRENT

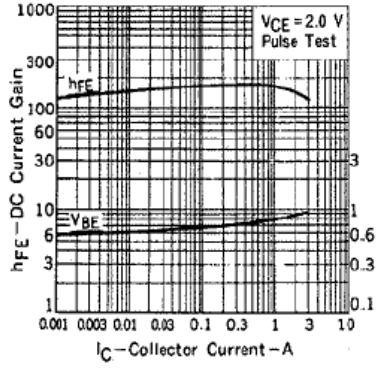

BASE AND COLLECTOR SATURATION VOLTAGE vs. COLLECTOR CURRENT

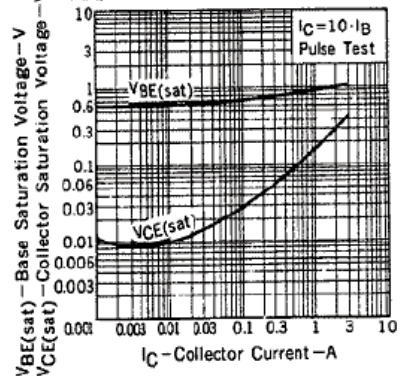

GAIN BANDWIDTH PRODUCT vs. COLLECTOR CURRENT

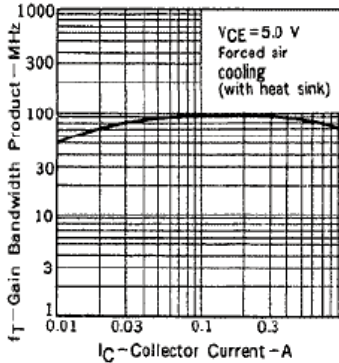

INPUT AND OUTPUT CAPACITANCE vs. REVERSE VOLTAGE

