

7.5-25.0/15.0-50.0 GHz GaAs MMIC Active Doubler

Features

- ✕ Excellent Broadband Mixer Driver
- ✕ Single Ended Fed Doubler with Distributed Buffer Amplifier
- ✕ Excellent LO Driver for Mimix Receivers
- ✕ +15 dBm Output Drive
- ✕ 100% On-Wafer RF, DC and Output Power Testing
- ✕ 100% Visual Inspection to MIL-STD-883 Method 2010

General Description

Mimix Broadband's single ended fed (no external balun required) 7.5-25.0/15.0-50.0 GHz GaAs MMIC doubler has a +15.0 dBm output drive and is an excellent LO doubler that can be used to drive fundamental mixer devices. It is also well suited to drive Mimix's XR1002 receiver device. This MMIC uses Mimix Broadband's 0.15 μm GaAs PHEMT device model technology, and is based upon electron beam lithography to ensure high repeatability and uniformity. The chip has surface passivation to protect and provide a rugged part with backside via holes and gold metallization to allow either a conductive epoxy or eutectic solder die attach process. This device is well suited for Millimeter-wave Point-to-Point Radio, LMDS, SATCOM and VSAT applications.

Chip Device Layout

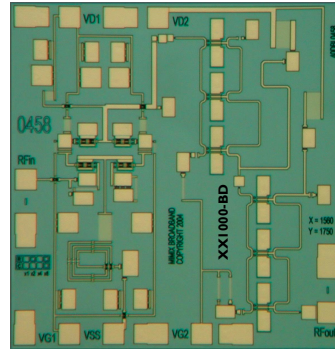

Absolute Maximum Ratings

Supply Voltage (Vd)	+6.0 VDC
Supply Voltage (Vss)	-6.0 VDC
Supply Current (Id)	300 mA
Supply Current (Iss)	60 mA
Gate Bias Voltage (Vg)	+0.3 VDC
Input Power (RF Pin)	+12.0 dBm
Storage Temperature (Tstg)	-65 to +165 °C
Operating Temperature (Ta)	-55 to MTTF Table ¹
Channel Temperature (Tch)	MTTF Table ¹

(1) Channel temperature affects a device's MTTF. It is recommended to keep channel temperature as low as possible for maximum life.

Electrical Characteristics (Ambient Temperature T = 25 °C)

Parameter	Units	Min.	Typ.	Max.
Input Frequency Range (fin)	GHz	7.5	-	25.0
Output Frequency Range (fout)	GHz	15.0	-	50.0
Input Return Loss (S11)	dB	-	TBD	-
Output Return Loss (S22)	dB	-	12.0	-
Harmonic Gain (fout)	dB	-	13	-
Fundamental Rejection (fin)	dBc	-	20	-
Saturated Output Power (Psat)	dBm	-	+15	-
RF Input Power (RF Pin)	dBm	-10.0	-	+10.0
Output Power at +0.0 dBm Pin (Pout)	dBm	-	+13.0	-
Drain Bias Voltage (Vd1,2)	VDC	-	+5.0	+5.5
Gate Bias Voltage (Vg1)	VDC	-1.2	-0.6	+0.1
Gate Bias Voltage (Vg2)	VDC	-1.2	0.0	+0.1
Supply Current (Id1,2) (Vd=5.0V, Vg1=-0.6V, Vg2=0.0V Typical)	mA	-	220	250
Source Voltage (Vss)	VDC	-5.5	-5.0	-2.0
Source Current (Iss)	mA	25	50	60

7.5-25.0/15.0-50.0 GHz GaAs MMIC Active Doubler

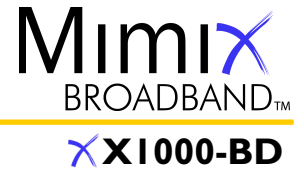

March 2007 - Rev 26-Mar-07

Doubler Measurements

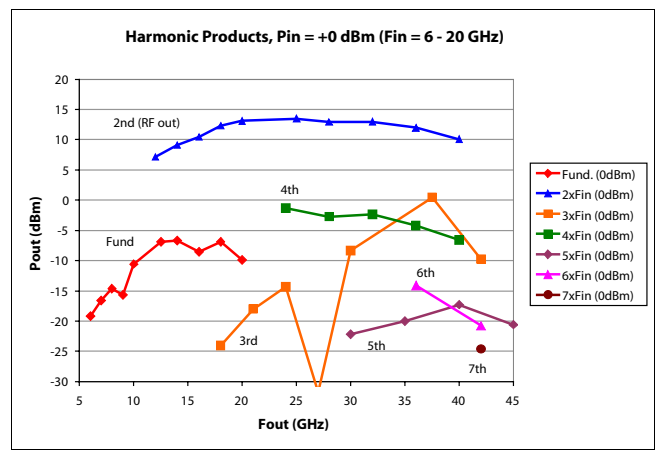
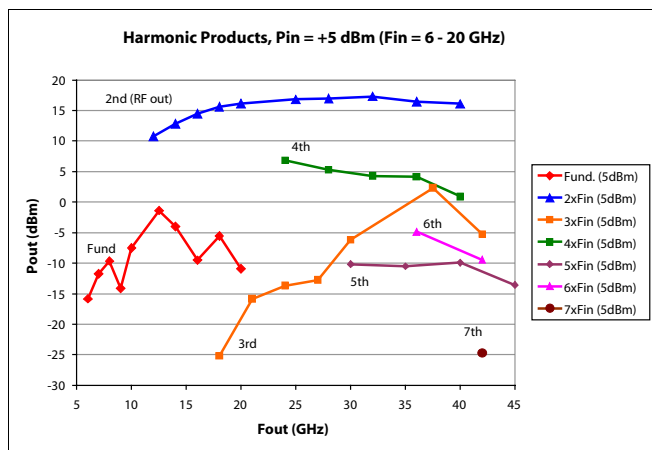
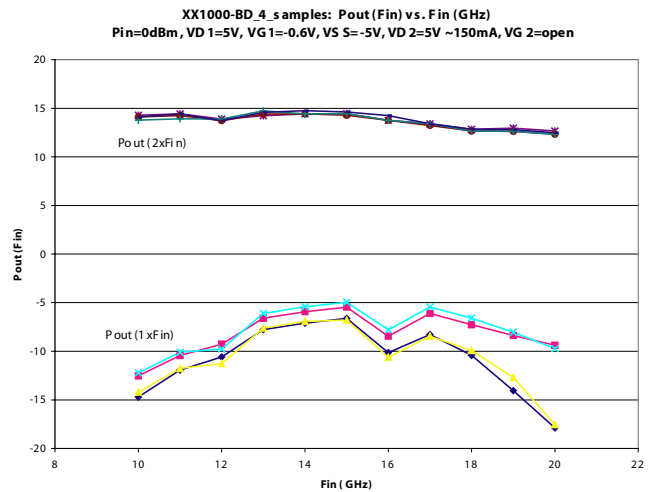
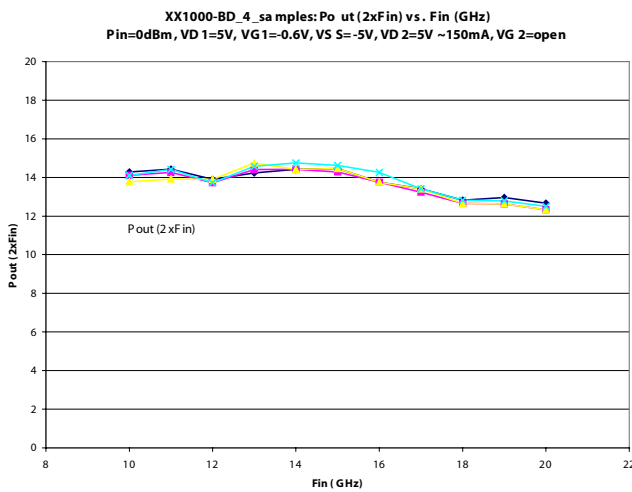
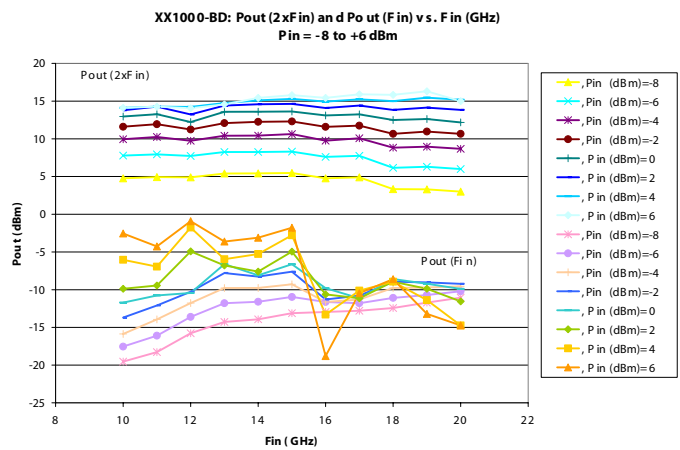
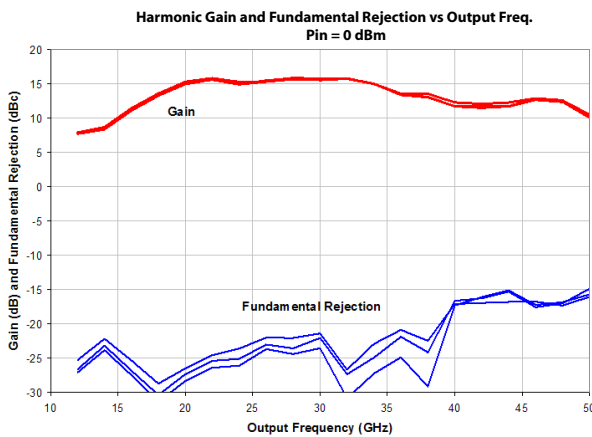

7.5-25.0/15.0-50.0 GHz GaAs MMIC Active Doubler

March 2007 - Rev 26-Mar-07

Mechanical Drawing

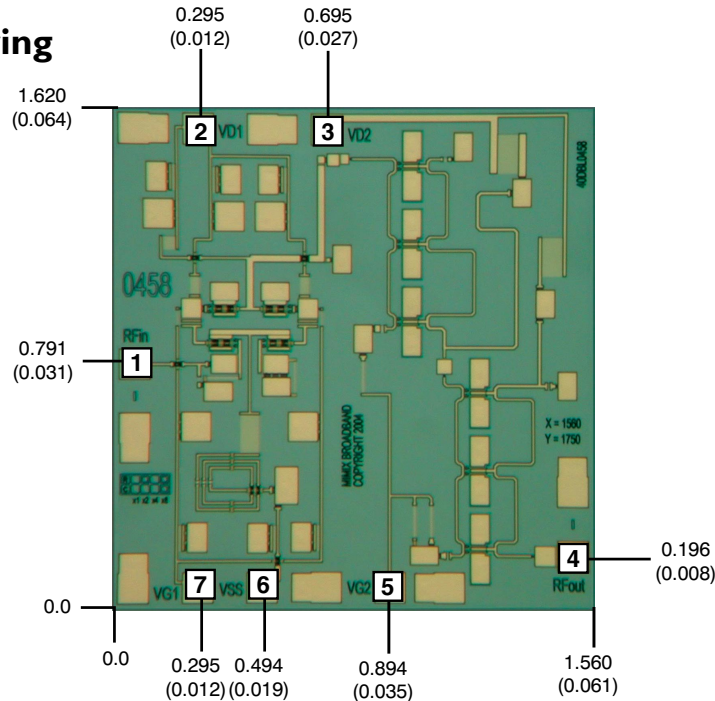

(Note: Engineering designator is 40DBL0458)

Units: millimeters (inches) Bond pad dimensions are shown to center of bond pad.
 Thickness: 0.110 +/- 0.010 (0.0043 +/- 0.0004), Backside is ground, Bond Pad/Backside Metallization: Gold
 All Bond Pads are 0.100 x 0.100 (0.004 x 0.004).
 Bond pad centers are approximately 0.109 (0.004) from the edge of the chip.
 Dicing tolerance: +/- 0.005 (+/- 0.0002). Approximate weight: 1.566 mg.

Bond Pad #1 (RF In)	Bond Pad #3 (Vd2)	Bond Pad #5 (Vg2)	Bond Pad #7 (Vg1)
Bond Pad #2 (Vd1)	Bond Pad #4 (RF Out)	Bond Pad #6 (Vss)	

Bias Arrangement

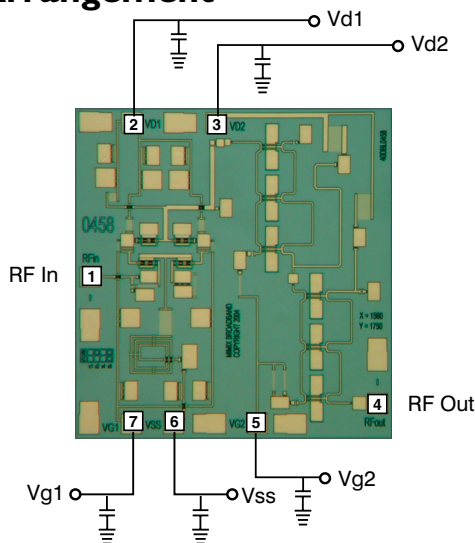

Bypass Capacitors - See App Note [2]

7.5-25.0/15.0-50.0 GHz GaAs MMIC Active Doubler



March 2007 - Rev 26-Mar-07

XX1000-BD

App Note [1] Biasing - It is recommended to separately bias each doubler stage with fixed voltages of $V_{d(1,2)}=5.0V$, $V_{ss}=-5.0V$ and $V_{g1}=-0.6V$. The typical DC currents are $I_{d1}=80mA$, $I_{d2}=140mA$ and $I_{ss}=50mA$. V_{g2} can be used for active control biasing of V_{d2} , or it can be left open and V_{d2} will self bias at approximately 140mA. Maximum output power is achieved with $V_{ss}=-5.0V$ and $I_{ss}=50mA$ but the device will operate with reduced bias to $V_{ss}=-2.0V$ and $I_{ss}=25mA$. It is also recommended to use active biasing on V_{d2} with V_{g2} to keep the currents constant as the RF power and temperature vary; this gives the most reproducible results. Depending on the supply voltage available and the power dissipation constraints, the bias circuit may be a single transistor or a low power operational amplifier, with a low value resistor in series with the drain supply used to sense the current. The gate of the pHEMT is controlled to maintain correct drain current and thus drain voltage. The typical gate voltage for $V_{g2}=-0.1V$. Typically the gate is protected with Silicon diodes to limit the applied voltage. Also, make sure to sequence the applied voltage to ensure negative gate bias is available before applying the positive drain supply.

App Note [2] Bias Arrangement -

For Individual Stage Bias (Recommended for doubler applications) -- Each DC pad ($V_{d1, 2}$, V_{ss} and $V_{g1, 2}$) needs to have DC bypass capacitance (~100-200 pF) as close to the device as possible. Additional DC bypass capacitance (~0.01 uF) is also recommended.

MTTF

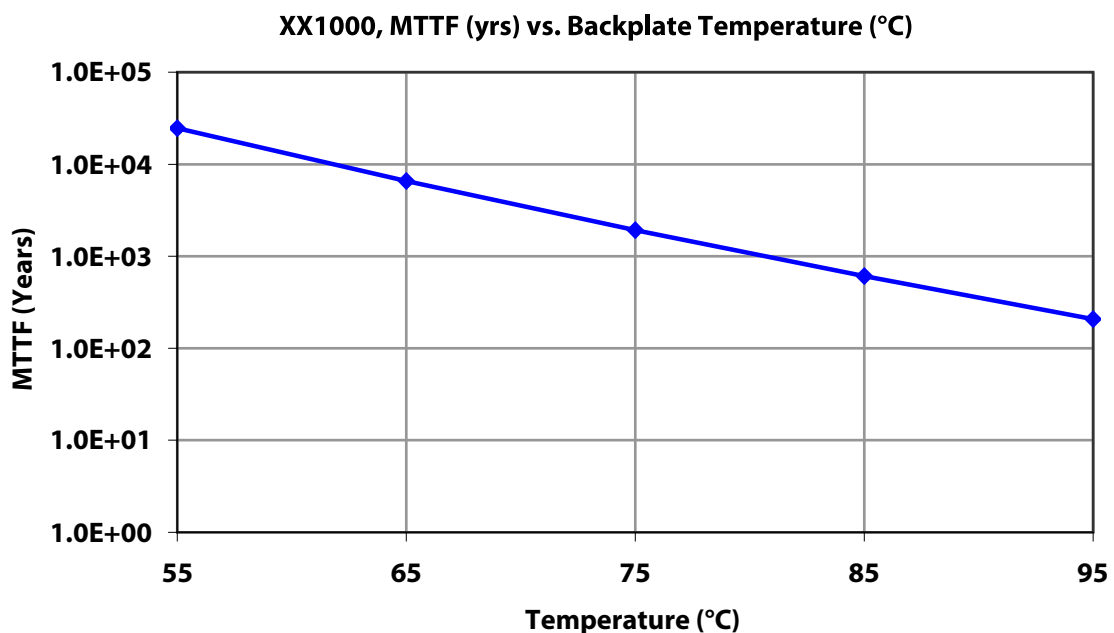

MTTF is calculated from accelerated life-time data of single devices and assumes isothermal back-plate.

Bias Conditions: $V_{d1,2} = 5.0V$, $I_{d1,2} = 220 mA$, $V_{ss} = -5.0V$, $I_{ss} = 50 mA$

7.5-25.0/15.0-50.0 GHz GaAs MMIC Active Doubler

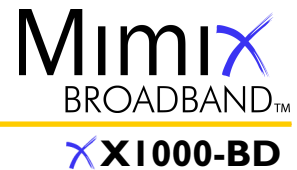

March 2007 - Rev 26-Mar-07

Handling and Assembly Information

CAUTION! - Mimix Broadband MMIC Products contain gallium arsenide (GaAs) which can be hazardous to the human body and the environment. For safety, observe the following procedures:

- *Do not ingest.*
- *Do not alter the form of this product into a gas, powder, or liquid through burning, crushing, or chemical processing as these by-products are dangerous to the human body if inhaled, ingested, or swallowed.*
- *Observe government laws and company regulations when discarding this product. This product must be discarded in accordance with methods specified by applicable hazardous waste procedures.*

Life Support Policy - Mimix Broadband's products are not authorized for use as critical components in life support devices or systems without the express written approval of the President and General Counsel of Mimix Broadband. As used herein: (1) Life support devices or systems are devices or systems which, (a) are intended for surgical implant into the body, or (b) support or sustain life, and whose failure to perform when properly used in accordance with instructions for use provided in the labeling, can be reasonably expected to result in a significant injury to the user. (2) A critical component is any component of a life support device or system whose failure to perform can be reasonably expected to cause the failure of the life support device or system, or to affect its safety or effectiveness.

ESD - Gallium Arsenide (GaAs) devices are susceptible to electrostatic and mechanical damage. Die are supplied in antistatic containers, which should be opened in cleanroom conditions at an appropriately grounded anti-static workstation. Devices need careful handling using correctly designed collets, vacuum pickups or, with care, sharp tweezers.

Die Attachment - GaAs Products from Mimix Broadband are 0.100 mm (0.004") thick and have vias through to the backside to enable grounding to the circuit. Microstrip substrates should be brought as close to the die as possible. The mounting surface should be clean and flat. If using conductive epoxy, recommended epoxies are Tanaka T53332LD, Die Mat DM6030HK or DM6030HK-Pt cured in a nitrogen atmosphere per manufacturer's cure schedule. Apply epoxy sparingly to avoid getting any on to the top surface of the die. An epoxy fillet should be visible around the total die periphery. For additional information please see the Mimix "Epoxy Specifications for Bare Die" application note. If eutectic mounting is preferred, then a fluxless gold-tin (AuSn) preform, approximately 0.001² thick, placed between the die and the attachment surface should be used. A die bonder that utilizes a heated collet and provides scrubbing action to ensure total wetting to prevent void formation in a nitrogen atmosphere is recommended. The gold-tin eutectic (80% Au 20% Sn) has a melting point of approximately 280° C (Note: Gold Germanium should be avoided). The work station temperature should be 310° C +/- 10° C. Exposure to these extreme temperatures should be kept to minimum. The collet should be heated, and the die pre-heated to avoid excessive thermal shock. Avoidance of air bridges and force impact are critical during placement.

Wire Bonding - Windows in the surface passivation above the bond pads are provided to allow wire bonding to the die's gold bond pads. The recommended wire bonding procedure uses 0.076 mm x 0.013 mm (0.003" x 0.0005") 99.99% pure gold ribbon with 0.5-2% elongation to minimize RF port bond inductance. Gold 0.025 mm (0.001") diameter wedge or ball bonds are acceptable for DC Bias connections. Aluminum wire should be avoided. Thermo-compression bonding is recommended though thermosonic bonding may be used providing the ultrasonic content of the bond is minimized. Bond force, time and ultrasonics are all critical parameters. Bonds should be made from the bond pads on the die to the package or substrate. All bonds should be as short as possible.

RoHS Compliant Parts - All Mimix products are RoHS compliant unless specifically ordered with Tin-Lead finish.

Ordering Information

Part Number for Ordering	Description
XX1000-BD-000V	Where "V" is RoHS compliant die packed in vacuum release gel paks
XX1000-BD-EV1	XX1000 die evaluation module