



8-/4-Channel ADCs with Simultaneous T/Hs and Reference

MAX155/MAX156

General Description

The MAX155/MAX156 are high-speed, 8-bit, multi-channel analog-to-digital converters (ADCs) with simultaneous track/holds (T/Hs) to eliminate timing differences between input channel samples. The MAX155 has 8 analog input channels, and the MAX156 has 4 analog input channels. Each channel has its own T/H, and all T/Hs sample at the same instant. The ADC converts a channel in 3.6 μ s and stores the result in an internal 8x8 RAM. The MAX155/MAX156 also feature a 2.5V internal reference and power-down capability, providing a complete, sampling data-acquisition system.

When operating from a single +5V supply, the MAX155/MAX156 perform either unipolar or bipolar, single-ended or differential conversions. For applications requiring wider dynamic range or bipolar conversions around ground, the VSS supply pin may be connected to -5V.

Conversions are initiated with a pulse to the WR pin, and data is accessed from the ADC's RAM with a pulse to the RD pin. A bidirectional interface updates the channel configuration and provides output data. The ADC may also be wired for output-only operation. The MAX155 comes in 28-pin DIP and wide SO packages, and the MAX156 comes in 24-pin narrow plastic DIP and 28-pin wide SO packages.

Applications

- Phase-Sensitive Data Acquisition
- Vibration and Waveform Analysis
- DSP Analog Input
- AC Power Meters
- Portable Data Loggers

Functional Diagram

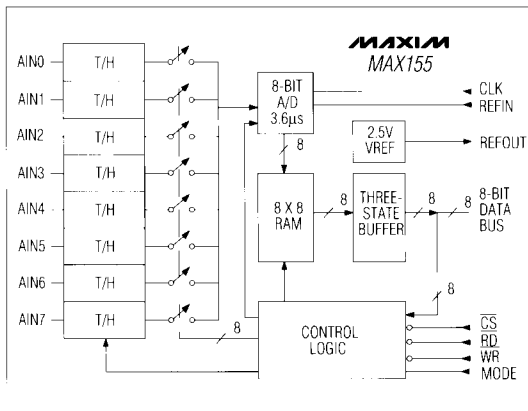

Features

- ◆ 8 Simultaneously Sampling Track/Hold Inputs
- ◆ 3.6 μ s Conversion Time per Channel
- ◆ Unipolar or Bipolar Input Range
- ◆ Single-Ended or Differential Inputs
- ◆ Mixed Input Configurations Possible
- ◆ +2.5V Internal Reference
- ◆ Single +5V or Dual \pm 5V Supply Operation

Ordering Information

PART	TEMP. RANGE	PIN-PACKAGE	ERROR (LSBs)
MAX155ACPI	0°C to +70°C	28 Plastic DIP	\pm 1/2
MAX155BCPI	0°C to +70°C	28 Plastic DIP	\pm 1
MAX155ACWI	0°C to +70°C	28 Wide SO	\pm 1/2
MAX155BCWI	0°C to +70°C	28 Wide SO	\pm 1
MAX155BC/D	0°C to +70°C	Dice*	\pm 1

Ordering information continued on last page.

* Contact factory for dice specifications.

Pin Configurations

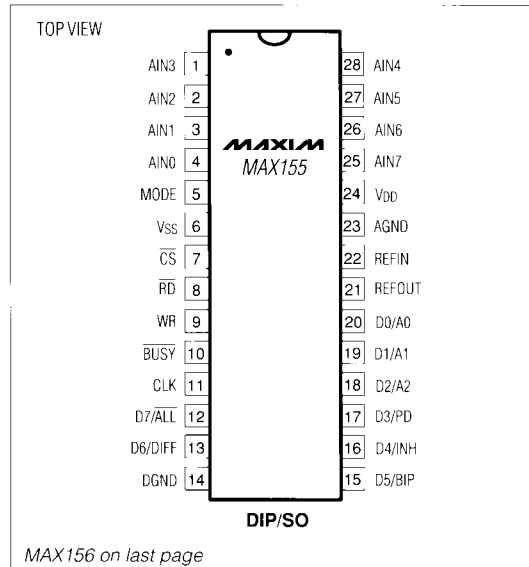

MAX156 on last page



8-/4-Channel ADCs with Simultaneous T/Hs and Reference

ABSOLUTE MAXIMUM RATINGS

V _{DD} to AGND	-0.3V, +6V
V _{DD} to DGND	-0.3V, +6V
AGND to DGND	-0.3V, V _{DD} +0.3V
V _{SS} to AGND	+0.3V, -6V
V _{SS} to DGND	+0.3V, -6V
CS, WR, RD, CLK, MODE to DGND	-0.3V, V _{DD} +0.3V
BUSY, D0-D7 to DGND	-0.3V, V _{DD} +0.3V
REFOUT to AGND	-0.3V, V _{DD} +0.3V
REFIN to AGND	-0.3V, V _{DD} +0.3V
AIN to AGND	V _{SS} -0.3V, V _{DD} +0.3V
Output Current (REFOUT)	30mA

Continuous Power Dissipation (T _A = +70°C)	
24-Pin Plastic DIP (derate 8.7mW/°C above +70°C)	696mW
24-Pin CERDIP (derate 12.5mW/°C above +70°C)	1000mW
28-Pin Plastic DIP (derate 9.09mW/°C above +70°C)	727mW
28-Pin Wide SO (derate 12.5mW/°C above +70°C)	1000mW
28-Pin CERDIP (derate 16.67mW/°C above +70°C)	1333mW
Operating Temperature Ranges:	
MAX155/MAX156_C_	0°C to +70°C
MAX155/MAX156_E_	-40°C to +85°C
MAX155_MJL	-55°C to +125°C
Storage Temperature Range	-65°C to +160°C
Lead Temperature (soldering, 10 sec)	+300°C

Stresses beyond those listed under "Absolute Maximum Ratings" may cause permanent damage to the device. These are stress ratings only, and functional operation of the device at these or any other conditions beyond those indicated in the operational sections of the specifications is not implied. Exposure to absolute maximum rating conditions for extended periods may affect device reliability.

ELECTRICAL CHARACTERISTICS

(V_{DD} = +5V, REFIN = +2.5V, External Reference, AGND = DGND = 0V, V_{SS} = 0V or -5V, f_{CLK} = 5MHz External, Unipolar Range, Single-Ended Mode, T_A = T_{MIN} to T_{MAX}, unless otherwise noted.)

PARAMETER	SYMBOL	CONDITIONS	MIN	TYP	MAX	UNITS
ACCURACY (Note 1)						
Resolution			8			Bits
Integral Linearity Error		MAX15_A			±1/2	LSB
		MAX15_B			±1	
No Missing Codes Resolution		Guaranteed monotonic	8			Bits
Offset Error (Unipolar)		MAX15_A			±1/2	LSB
		MAX15_B			±1	
Offset Error (Bipolar)		MAX15_A			±1	LSB
		MAX15_B			±2	
Gain Error		Unipolar	MAX15_A		±1	LSB
			MAX15_B		±1	
		Bipolar	MAX15_A		±1	
			MAX15_B		±2	
Channel-to-Channel Matching		MAX15_A		±1/2	LSB	
		MAX15_B		±1		
DYNAMIC PERFORMANCE (V _{IN} = 50kHz, 2.5Vp-p sine wave sampled at 220ksamples/sec)						
Signal-to-Noise and Distortion Ratio	SINAD	MAX15_A		48		dB
		MAX15_B		47		
Total Harmonic Distortion	THD			-60		dB
Spurious-Free Dynamic Range	SFDR			-62		dB
Small-Signal Bandwidth				4		MHz
Aperture Delay				20		ns
Aperture Delay Matching (Note 2)					4	ns

8-/4-Channel ADCs with Simultaneous T/Hs and Reference

MAX155/MAX156

ELECTRICAL CHARACTERISTICS (continued)

(V_{DD} = +5V, REF_{IN} = +2.5V, External Reference, AGND = DGND = 0V, V_{SS} = 0V or -5V, f_{CLK} = 5MHz External, Unipolar Range, Single-Ended Mode, T_A = T_{MIN} to T_{MAX}, unless otherwise noted.)

PARAMETER	SYMBOL	CONDITIONS	MIN	TYP	MAX	UNITS					
ANALOG INPUT											
Voltage Range Unipolar, Single-Ended		AIN ₍₊₎ to AGND	0		VREF	V					
Unipolar, Differential		AIN ₍₊₎ to AIN ₍₋₎	0		VREF						
Bipolar, Single-Ended		AIN ₍₊₎ to AGND	-VREF		VREF						
Bipolar, Differential		AIN ₍₊₎ to AIN ₍₋₎	-VREF		VREF						
Common-Mode Range		Differential mode	V _{SS}		V _{DD}						
DC Input Impedance		AIN = V _{DD}	10			MΩ					
REFERENCE INPUT											
REF _{IN} Range (for specified performance) (Note 2)			2.375	2.500	2.625	V					
I _{REF}		REF _{IN} = 2.5V			1	mA					
REFERENCE OUTPUT (C_L = 4.7μF)											
Output Voltage		I _L = 0mA	T _A = +25°C	2.44	2.50	2.56	V				
			T _A = T _{MIN} to T _{MAX}	2.38	2.50	2.62					
Load Regulation		T _A = +25°C, I _{OUT} = 0mA to 10mA			-10	mV					
Power-Supply Sensitivity		T _A = +25°C, V _{DD} = 5V ±5%		±1	±3	mV					
Temperature Drift				±100		ppm/°C					
LOGIC INPUTS (Mode = Open Circuit)											
CS, RD, WR, CLK, D0-D7 (when inputs) Input Low Voltage	V _{IL}				0.8	V					
							Input High Voltage	V _{IH}	2.4		
Input Current	I _{IN}				±10	μA					
Input Capacitance (Note 2)	C _{IN}				15	pF					
MODE Input Low Voltage	V _{IL}				0.5	V					
							Input High Voltage	V _{IH}	V _{DD} - 0.5		
							Input Mid-Level Voltage	V _{MID}	V _{DD} /2 - 0.5		V _{DD} /2 + 0.5
							Input Floating Voltage	V _{FLT}			V _{DD} /2
							Input Current	I _{IN}		±50	±100
LOGIC OUTPUTS											
BUSY, D0-D7 Output Low Voltage	V _{OL}	I _{OUT} = 1.6mA			0.4	V					
							Output High Voltage	V _{OH}	I _{OUT} = -360μA	4	
D0-D7 Floating State Leakage					±10	μA					
Floating State Output Capacitance (Note 2)	C _{OUT}				15	pF					
Conversion Time		f _{CLK} = 5MHz, single channel	3.6		3.8	μs					

8-/4-Channel ADCs with Simultaneous T/Hs and Reference

MAX155/MAX156

ELECTRICAL CHARACTERISTICS (continued)

(V_{DD} = +5V, REF_{IN} = +2.5V, External Reference, AGND = DGND = 0V, V_{SS} = 0V or -5V, f_{CLK} = 5MHz External, Unipolar Range, Single-Ended Mode, T_A = T_{MIN} to T_{MAX}, unless otherwise noted.)

PARAMETER	SYMBOL	CONDITIONS	MIN	TYP	MAX	UNITS
POWER REQUIREMENTS						
Positive Power-Supply Voltage	V _{DD}		4.75		5.25	V
Positive Power-Supply Current	I _{DD}	PD = 0		18	24	mA
			MAX155			
				9	12	
		PD = 1		25	100	μA
		CLK, CS, WR, RD = 0V or V _{DD} ; D _{OUT} = 0V or V _{DD}				
Negative Power-Supply Voltage	V _{SS}		0		-5	V
Neq Supply Current	I _{SS}	PD = 0		2	50	μA
		PD = 1		2	50	
Pow (cha ejection scale error)		V _{DD} = 5V ±5%, V _{SS} = 0V		±0.1	±0.25	LSB
		V _{DD} = 5V, V _{SS} = -5V ±5%		±0.1		

TIMING CHARACTERISTICS (Note 3, Figures 1-7)

(V_{DD} = +5V, REF_{IN} = +2.5V, External Reference, AGND = DGND = 0V, V_{SS} = 0V or -5V, T_A = T_{MIN} to T_{MAX}, unless otherwise noted.)

PARAMETER	SYMBOL	CONDITIONS	MIN	TYP	MAX	UNITS
CS to WR Setup Time	t _{CWS}		0			ns
CS to WR Hold Time	t _{CWH}		0			ns
CS to RD Setup Time	t _{CRS}		0			ns
CS to RD Hold Time (Note 2)	t _{CRH}		0			ns
WR Low Pulse Width	t _{WR}	MAX15_C/E	100		2000	ns
		MAX155M	120		2000	
RD Low Pulse Width	t _{RD}	MAX15_C/E	100			ns
		MAX155M	120			
RD High Pulse Width (Note 2)	t _{RDH}	MAX15_C/E	180			ns
		MAX155M	200			
WR to RD Delay (Note 2)	t _{WRD}	MAX15_C/E	280			ns
		MAX155M	300			
WR to BUSY Low Delay	t _{WBD}	MAX15_C/E			220	ns
		MAX155M			240	
BUSY High to WR Delay (to update configuration register) (Notes 2, 3)	t _{BWD}		50			ns
CLK to WR Delay (acquisition time) (Note 2)	t _{ACQ}		800			ns
BUSY High to RD Delay (Notes 2, 3)	t _{BRD}		50			ns
Address-Setup Time	t _{AS}		120			ns
Address-Hold Time	t _{AH}		0			ns

8-/4-Channel ADCs with Simultaneous T/Hs and Reference

MAX155/MAX156

TIMING CHARACTERISTICS (continued) (Note 3, Figures 1-7)

($V_{DD} = +5V$, $REFIN = +2.5V$, External Reference, $AGND = DGND = 0V$, $V_{SS} = 0V$ or $-5V$, $T_A = T_{MIN}$ to T_{MAX} , unless otherwise noted.)

PARAMETER	SYMBOL	CONDITIONS	MIN	TYP	MAX	UNITS
\overline{RD} to Data Valid (Note 4)	tDV	MAX15_C/E	100			ns
		MAX155M	120			
\overline{RD} to Data Three-State Output (Note 5)	tTR	MAX15_C/E	80			ns
		MAX155M	100			
CLK to \overline{BUSY} Delay (Note 2)	tCB			100	300	ns
CLK Frequency			0.5		5.0	MHz

Note 1: $V_{DD} = +5V$, $REFIN = +2.5V$, $V_{SS} = 0V$. Performance at $\pm 5\%$ power-supply tolerance is guaranteed by Power-Supply Rejection test.

Note 2: Guaranteed by design, not production tested.

Note 3: All input control signals are specified with $t_r = t_f = 20ns$ (10% to 90% of +5V) and timed from a +1.6V voltage level. Output signals are timed from V_{OH} and V_{OL} .

Note 4: tDV is the time required for an output to cross +0.8V or +2.4V measured with load circuit of Figure 1.

Note 5: tTR is the time required for the data lines to change 0.5V, measured with load circuits of Figure 2.

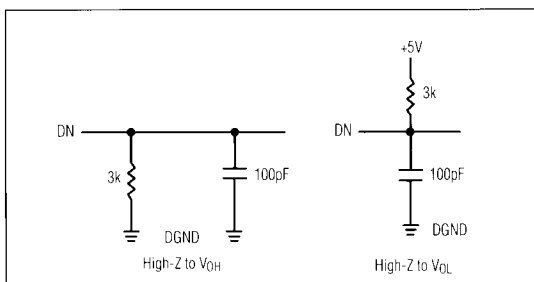

Figure 1. Load Circuits for Data-Access Timing

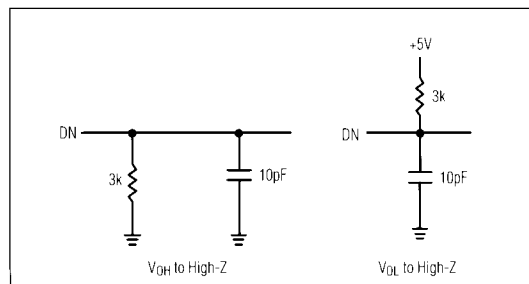

Figure 2. Load Circuits for Three-State Output Timing

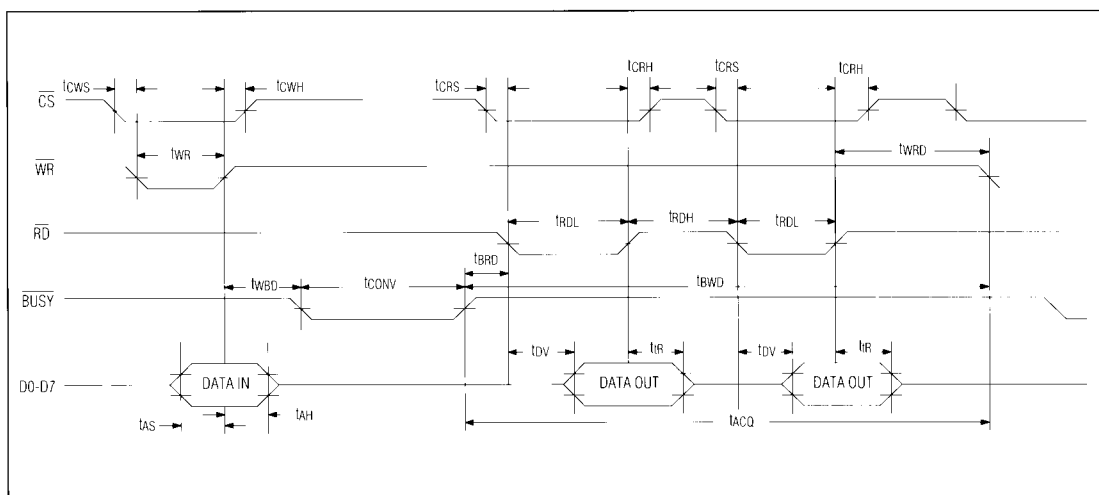

Figure 3. Write and Read Timing

8-/4-Channel ADCs with Simultaneous T/Hs and Reference

MAX155/MAX156

Pin Description

MAX155		MAX156		NAME	FUNCTION
DIP/SO	DIP	SO			
1	23	26	AIN3	Sampling Analog Input, channel 3	
2	24	28	AIN2	Sampling Analog Input, channel 2	
3	1	2	AIN1	Sampling Analog Input, channel 1	
4	2	4	AIN0	Sampling Analog Input, channel 0	
5	3	5	MODE	Mode configures multiplexer and converter. See Table 4.	
6	4	6	V _{SS}	Negative Supply. Power V _{SS} with -5V for extended input range.	
7	5	7	CS	CHIP SELECT Input must be low for the ADC to recognize RD, or WR.	
8	6	8	RD	READ Input reads data sequentially from RAM.	
9	7	9	WR	WRITE Input's rising edge initiates conversion and updates channel configuration register. Falling edge samples inputs.	
10	8	10	BUSY	BUSY Output low when conversion is in progress.	
11	9	11	CLK	External Clock Input	
12	10	12	D7/ALL	Three-State Data Output Bit 7 (MSB) / Sequential or Specific Conversion	
13	11	13	D6/DIFF	Three-State Data Output Bit 6 / Single-Ended/Differential Select	
14	12	14	DGND	Digital Ground	
15	13	15	D5/BIP	Three-State Data Output Bit 5 / Unipolar/Bipolar Conversion	
16	14	16	D4/INH	Three-State Data Output Bit 4 / Inhibit Conversion Input	
17	15	17	D3/PD	Three-State Data Output Bit 3 / Power-Down Input	
18	16	18	D2/A2	Three-State Data Output Bit 2 / RAM Address Bit A2 (MAX155 only)	
19	17	19	D1/A1	Three-State Data Output Bit 1 / RAM Address Bit A1	
20	18	20	D0/A0	Three-State Data Output Bit 0 / RAM Address Bit A0	
21	19	21	REFOUT	Reference Output, +2.5V	
22	20	22	REFIN	Reference Input, +2.5V normally	
23	21	23	AGND	Analog Ground	
24	22	24	V _{DD}	Power-Supply Voltage, +5V normally	
25-28		—	AIN7-4	Sampling Analog Input, channels 7-4	
	—	1, 3, 25, 27	N.C.	No Internal Connection - floating pin.	

8-/4-Channel ADCs with Simultaneous T/Hs and Reference

Detailed Description A/D Converter Operation

The MAX155/MAX156 contain a 3.6μs successive approximation ADC and 8/4 track-and-hold (T/H) inputs. When a conversion is started, all AIN inputs are simultaneously sampled. All channels sample whether or not they are selected for the conversion. Either a single-channel or multi-channel conversion may be requested and channel configurations may be mixed. ADC results are then stored in an internal RAM.

In hard-wired mode (see *Multiplexer and A/D Configurations* section) multi-channel conversions are initiated with one write operation. In input/output (I/O) mode, multi-channel configurations are set up prior to the conversion by loading channel selections into the configuration reg-

ister. This register also selects single-ended/differential, unipolar/bipolar (Figure 9), power-down and other functions. Each channel selection requires a separate write operation (i.e. 8 writes for 8 channels), but only after power-up. Once the desired channel arrangement is loaded, each subsequent write converts all selected channels without reconfiguring the multiplexer (mux). I/O mode requires more write operations, but provides more flexibility than hard-wired mode.

To access conversion results, successive \overline{RD} pulses automatically sequence through RAM, beginning with channel 0. Each \overline{RD} pulse increments the RAM address counter, which resets to 0 when \overline{WR} goes low in multi-channel conversions. An arbitrary RAM location may also be read by writing a 1 to INH while loading the RAM address (A0-A2), and then performing a read operation.

Table 1. Multiplexer Configurations

PIN*	INPUT	FUNCTION
D0/A0 D1/A1 D2/A2	1 or 0	A0-A2 select a multiplexer channel for the configurations described below, or select a RAM address for reading with a subsequent \overline{RD} .
D3/PD	0	Normal ADC operation
	1	Power-Down reduces the power-supply current. Configuration data may be loaded and is maintained during power-down.
D4/INH	0	A conversion starts when \overline{WR} goes high.
	1	Inhibits the conversion when \overline{WR} goes high. Allows mux configuration to be loaded and RAM locations to be accessed without starting a conversion.
D5/BIP**	0	Unipolar conversion (Figure 9a) for the channel specified by A0-A2. Input range = 0V to VREF.
	1	Bipolar conversion (Figure 9b) for the channel specified by A0-A2. Input range = ±VREF.
D6/DIFF**	0	Single-ended configuration for the channel specified by A0-A2 as described in Table 2.
	1	Differential configuration for the channel specified by A0-A2 as described in Table 2.
D7/ \overline{ALL}	0	All previously configured channels are converted. Data is read with consecutive \overline{RD} pulses, beginning with the lowest configured channel.
	1	Only the channel specified by A2-A0 is converted. A single \overline{RD} pulse reads the result of that conversion.

* Configuration inputs are shared with data outputs D0-D7. The functions of D0-D7 are not described in this table.

** DIFF and BIP are not implemented on the current conversion, but go into effect on the following conversion.

8-/4-Channel ADCs with Simultaneous T/Hs and Reference

Multiplexer and A/D Configuration

A conversion is started with a \overline{WR} pulse. All channels sample on \overline{WR} 's falling edge. Mux configuration data is loaded on \overline{WR} 's rising edge. In I/O mode (MODE = Open Circuit), selections for channel number, single- or multi-channel conversion, unipolar or bipolar input, and single-ended or differential input are made with A0-A2, ALL, BIP, and DIFF (Table 1). These input pins are also shared with the RAM data outputs D0-D7. An alternate, simpler interface is provided by the hard-wired mode, which selects some general mux configurations without requiring ADC programming. Hard-wired connections of MODE and VSS

select from 4 mux configurations as listed in Table 4 (see *Hard-Wired Mode* section).

On the rising edge of \overline{WR} , the mux configuration register is updated; falling edge initiates sampling of all inputs. A channel selection can be implemented on the current conversion, but changes from unipolar to bipolar (with BIP) or from single-ended to differential operation (with DIFF) do not go into effect until the following \overline{WR} . This can be overcome by writing to the configuration register while inhibiting the conversion (INH = 1), or by changing DIFF and BIP one conversion early, i.e. on the previous write.

Table 2. Single-Ended Channel Selection (MODE = Open Circuit)

MUX ADDRESS				SINGLE-ENDED CHANNEL SELECTION								
A0	A1	A2	DIFF	0	1	2	3	4	5	6	7	AGND
0	0	0	0	+								-
1	0	0	0		+							-
0	1	0	0			+						-
1	1	0	0				+					-
0	0	1	0					+				-
1	0	1	0						+			-
0	1	1	0							+		-
1	1	1	0								+	-

Note: Shaded areas represent MAX156 operation

Table 3. Differential Channel Selection (MODE = Open Circuit)

MUX ADDRESS				DIFFERENTIAL CHANNEL SELECTION							
A0	A1	A2	DIFF	0	1	2	3	4	5	6	7
0	0	0	1	+	-						
0	1	0	1			+	-				
0	0	1	1					+	-		
0	1	1	1							+	-
1	0	0	1	-	+						
1	1	0	1			-	+				
1	0	1	1					-	+		
1	1	1	1							-	+

Note: Shaded areas represent MAX156 operation.

8-/4-Channel ADCs with Simultaneous T/Hs and Reference

Interface Timing

Input/Output Mode, Multi-Channel Conversion Timing

I/O mode is selected when the MODE input is open circuit. In I/O mode, the mux configuration register determines the conversion type. The register is updated on the rising edge of \overline{WR} .

Table 1 lists all conversion options. For example, at D6/DIFF, a logic 0 or 1 selects a single-ended or differential conversion. Data is loaded into addressed locations in the configuration register with a series of \overline{WR} pulses. If INH is high while writing, no conversion takes place. A conversion is started by writing INH = 0 to the configuration register. When a change is made to the contents of the configuration register, a "dummy" conversion may be necessary. This is due to a built-in latency of one full conversion for unipolar/bipolar and single-ended/differential selections.

It is not necessary to update the configuration register before every conversion. A particular mux configuration must be loaded only once after power-up (but the configuration may require several writes to be loaded). A mux configuration is retained for successive conversions and during power-down (PD = 1) so that reconfiguring is unnecessary when the ADC returns to normal operation (PD = 0). Configuration and RAM data is lost only when power is removed from the ADC at VDD.

When updating the configuration register, INH should be high for all except the last \overline{WR} so the conversion is not started until the mux is set. On \overline{WR} 's falling edge, all input channels sample simultaneously. \overline{BUSY} goes low at the beginning of the conversion, and channels are converted sequentially starting with the lowest selected channel. When \overline{BUSY} goes high, conversion results are stored in RAM. At conversion end, a microprocessor (μ P) can access the RAM contents with consecutive \overline{RD} pulses. The first accessed data is the lowest channel's result.

Subsequent \overline{RD} pulses access conversion results for the remaining channels.

The configuration data determines which RAM locations are sequentially read by consecutive \overline{RD} pulses, so new data should be placed in the configuration register only after a full \overline{RD} operation. It is not necessary to update the configuration register for every conversion. A new conversion is initiated with a \overline{WR} pulse (when INH = 0), regardless of the number of channels that have been read.

Figure 4a shows the MAX155 timing for an 8-channel unipolar configuration. 8 channels are configured and 8 consecutive \overline{RD} pulses access data. Figure 4b illustrates 4-channel differential conversion timing involving 4 sampled channels and 4 \overline{RD} pulses. In cases where conflicting differential configurations are loaded, the last channel selected with DIFF = 1 will be the positive input of the differential channel.

Input/Output Mode, Single-Channel Conversion Timing

Figure 5a shows timing for a single-channel ($\overline{ALL} = 1$), single-ended conversion; Figure 5b shows a differential conversion. With MODE floating, the configuration register is updated on the rising edge of \overline{WR} . \overline{BUSY} goes low at the beginning of the conversion and returns high when the channel designated by the configuration register has been converted. All channels are sampled on the falling edge of \overline{WR} even if only a single channel has been requested. At conversion end, the μ P can read the result for the selected channel with a single \overline{RD} pulse. Subsequent \overline{RD} pulses will access old conversion results remaining in other RAM locations. The next conversion is initiated with a \overline{WR} pulse, regardless of the number of channels that have been read.

INH and A0-A2, in the configuration register, access locations in RAM. INH = 1 allows the RAM address pointer to be updated without starting a conversion. A \overline{RD} pulse then reads the contents of the addressed location.

8-/4-Channel ADCs with Simultaneous T/Hs and Reference

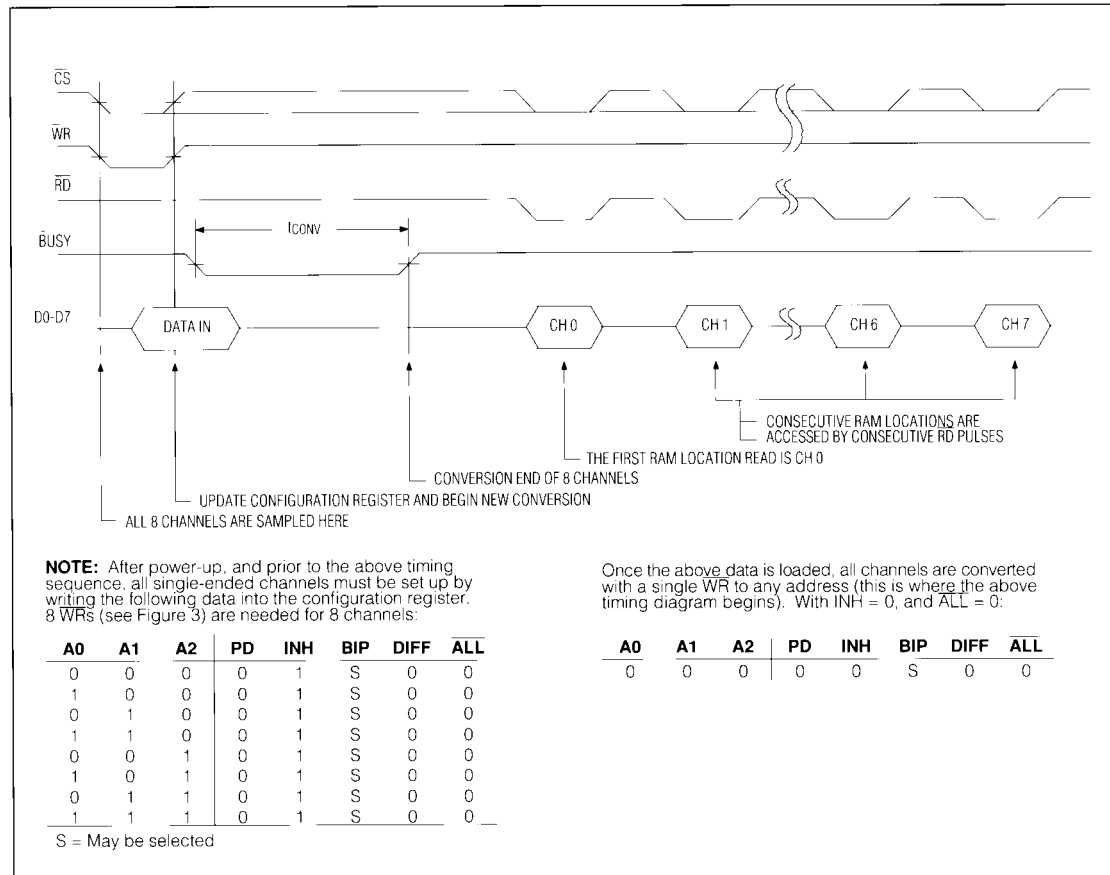

Figure 4a. Input/Output Mode Timing - Eight Single-Ended Conversions

8-/4-Channel ADCs with Simultaneous T/Hs and Reference

MAX155/MAX156

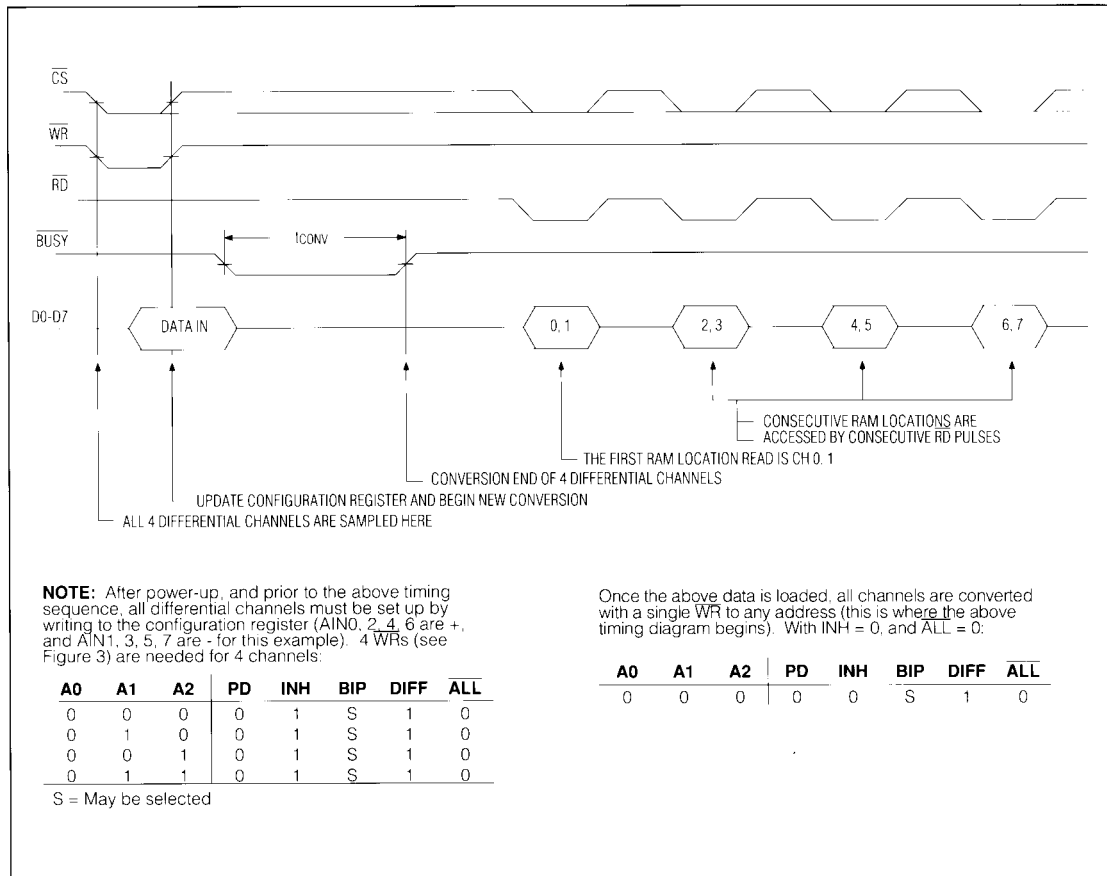

Figure 4b. Input/Output Mode Timing - Four Differential Conversions

8-/4-Channel ADCs with Simultaneous T/Hs and Reference

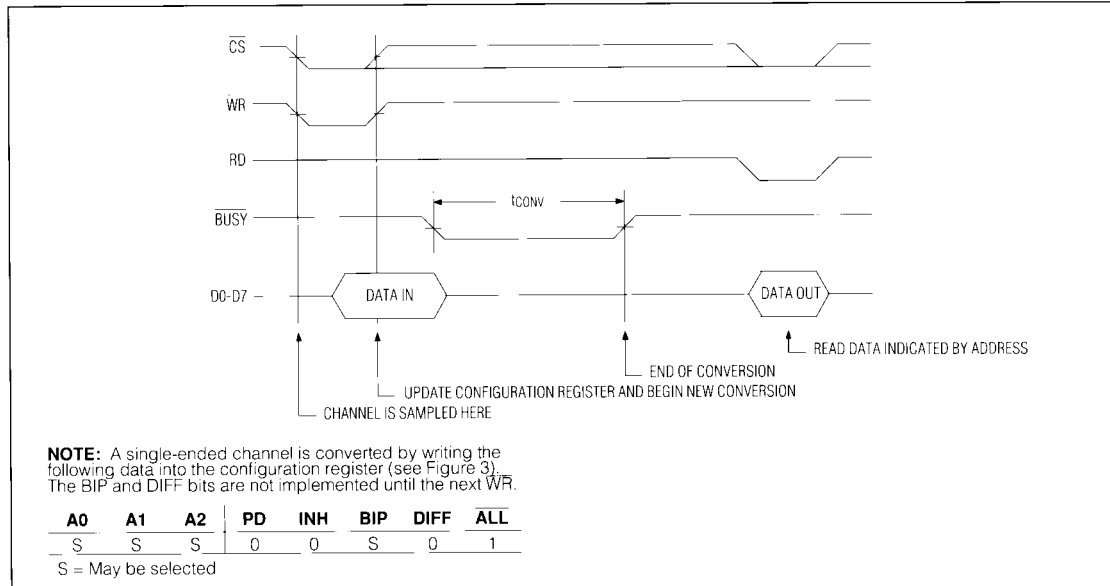

Figure 5a. Input/Output Mode Timing - Single-Channel, Single-Ended Conversion

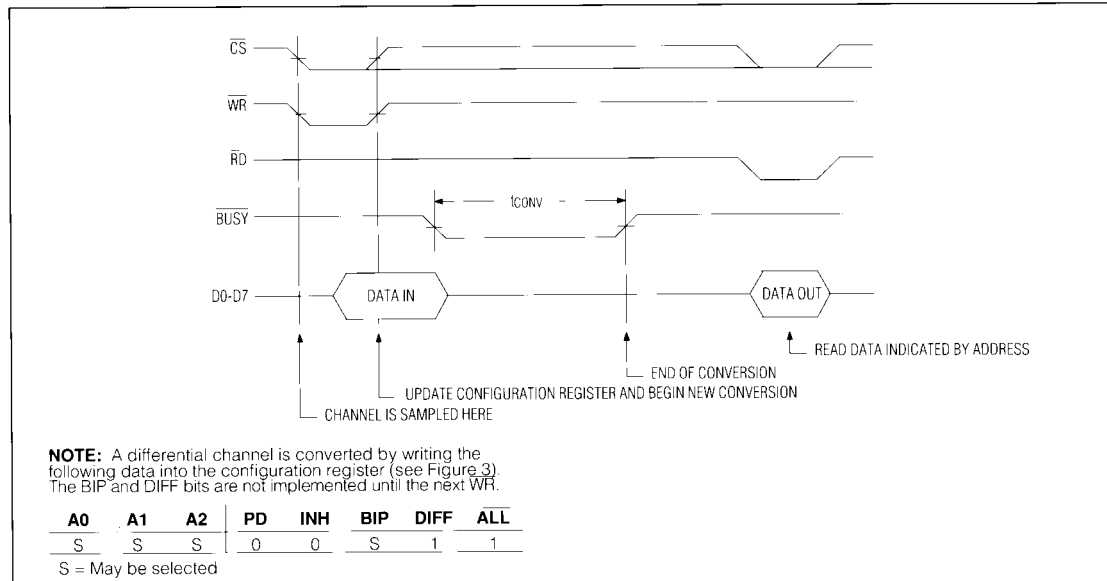

Figure 5b. Input/Output Mode Timing - Single-Channel, Differential Conversion

8-/4-Channel ADCs with Simultaneous T/Hs and Reference

MAX155/MAX156

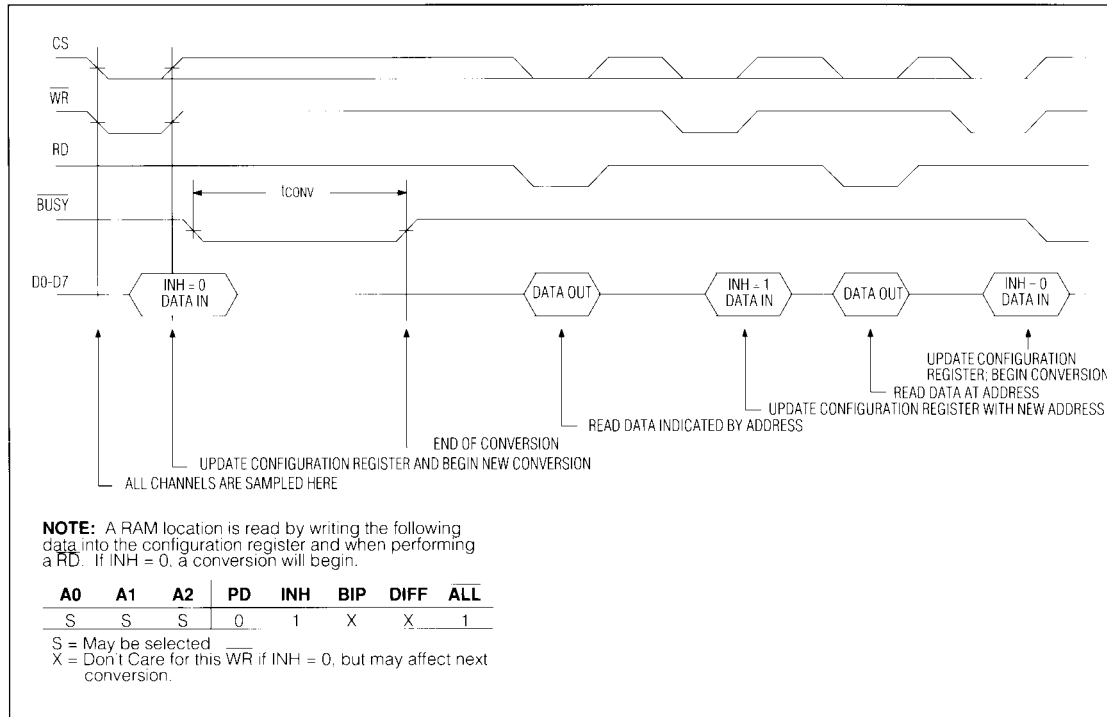

Figure 6. Input/Output Mode Timing - Reading Arbitrary RAM Locations

Hard-Wired Mode

For simpler applications, the MODE and V_{SS} pins can be hard-wired to specify the type of conversion as outlined in Table 4. In this mode, the configuration register is not used, so input data on D0-D7 is ignored. For example, with MODE tied low, an 8-channel, single-ended conversion begins with WR. With MODE tied high, a 4-channel, differential conversion is initiated with WR. Again, the configuration register is not affected by the data present on D0-D7. These conversions are otherwise identical to those shown in Figure 4.

Analog Considerations

Internal Reference

The internal 2.5V reference (REFOUT) must be bypassed to AGND (Figure 8a) with a 4.7μF electrolytic and a 0.1μF ceramic capacitor to ensure stability.

External Reference

If an external voltage reference is used at REFIN, REFOUT must either be bypassed (Figure 8b) or disabled to pre-

Table 4. Hard-Wired Mode - Multiplexer Selections

MODE	V _{SS}	CONVERSION TYPE
OPEN CIRCUIT	X	Multiplexer configuration register determines conversion type. Not hard-wired.
0	AGND	8-Channel, Single-Ended, Unipolar Conversion
1	AGND	4-Channel, Differential, Unipolar Conversion
0	-5V	8-Channel, Single-Ended, Bipolar Conversion
1	-5V	4-Channel, Differential, Bipolar Conversion

vent its output from oscillating and generating unwanted conversion noise elsewhere in the ADC. If component count is critical when using an external reference, REFOUT may be disabled by connecting it to V_{DD}. In this case, the unused internal reference does not need a bypass cap. A disadvantage of tying REFOUT to V_{DD} is that power-down current will be increased by about 250μA above the specification limits.

8-/4-Channel ADCs with Simultaneous T/Hs and Reference

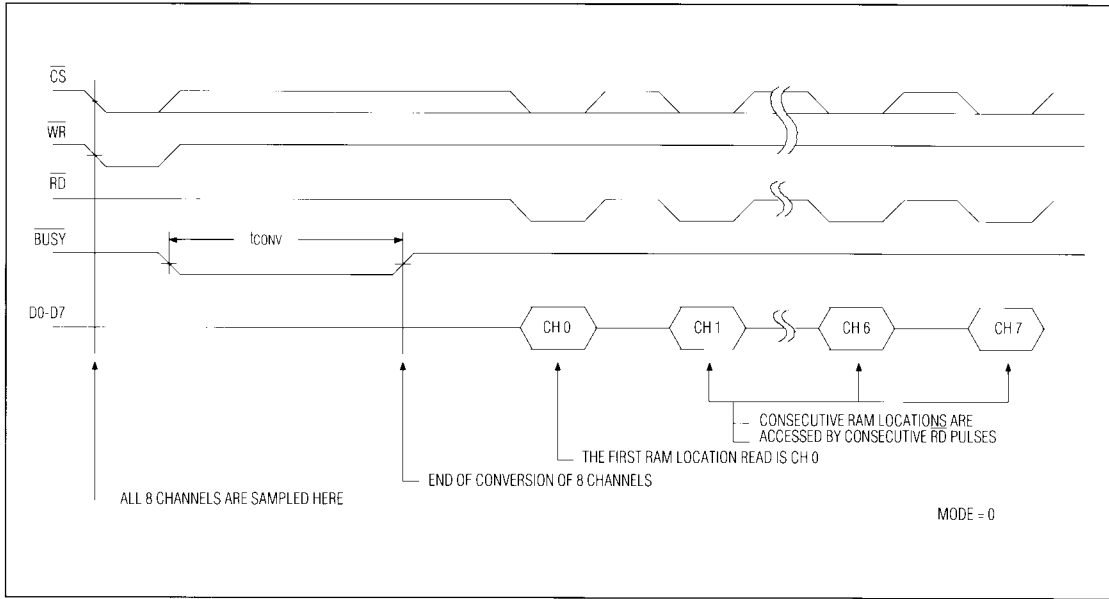

Figure 7a. Hard-Wired Mode Timing - Eight Single-Ended Conversions

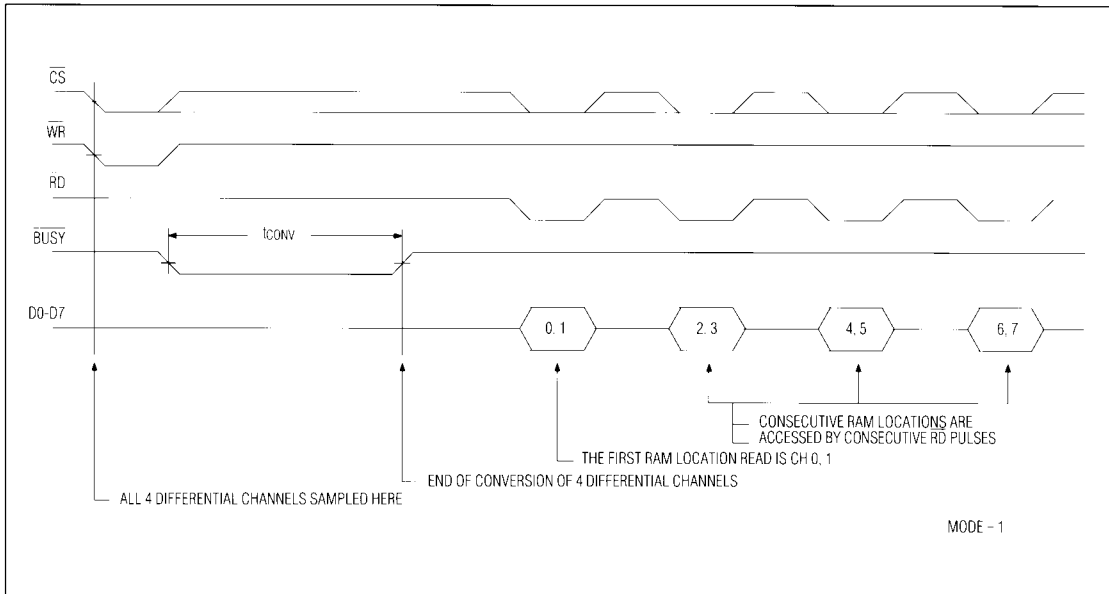

Figure 7b. Hard-Wired Mode Timing - Four Differential Conversions

8-/4-Channel ADCs with Simultaneous T/Hs and Reference

MAX155/MAX156

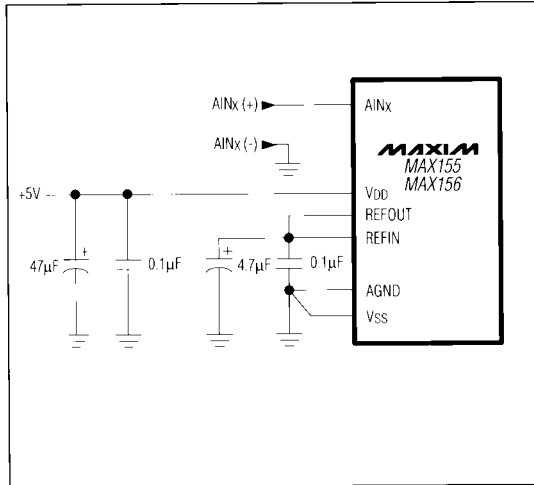

Figure 8a. Internal Reference

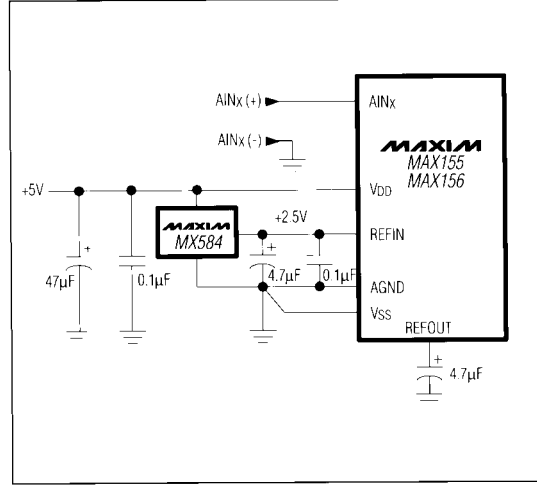

Figure 8b. External Reference, +2.5V Full Scale

Power-Down Mode

The MAX155/MAX156 may be placed in a powered-down state by writing a 1 to the PD location in the configuration register (Table 1). The register may be updated while in this state (to change mux configurations or exit power-down mode) and all register contents are retained; however, no data can be read from RAM and no conversions can be started. The power-down command is implemented on WR's rising edge.

To minimize current drain, the MAX155/MAX156 internal reference is turned off during power-down. When returning to normal operation (PD = 0), up to 5ms may be needed to allow the reference to recharge its 4.7µF bypass capacitor before a conversion is performed. If an external reference is used, and remains on during power-down, a conversion can be started within 50µs after loading PD with a 0.

Bypassing

A 47µF electrolytic and a 0.1µF ceramic capacitor should bypass VDD to AGND. If input signals below ground are expected, a negative supply is necessary. In that case, VSS should be bypassed to AGND with a 4.7µF and 0.1µF combination.

The internal reference requires a 4.7µF and 0.1µF combination. If an external voltage reference is used, bypass REFIN to AGND with a 4.7µF capacitor close to the chip. When an external reference is used, REFOUT must still be either bypassed or connected to VDD.

Track/Hold Amplifiers

The MAX155/MAX156 T/H amplifiers' high input impedance usually requires no input buffering. All T/Hs sample simultaneously. For best results, the analog inputs should not exceed the power-supply rails (VDD, VSS) by more than 50mV.

The time required for the T/H to acquire an input signal for one channel is a function of how quickly the channel input capacitance is charged. If the source impedance of the input signal is high, acquisition takes longer, and more time must be allowed between conversions. Acquisition time is calculated by:

$$t_{ACQ} = 8(R_S + R_{IN}) \times 4pF \text{ (but never less than 800ns),}$$

where $R_{IN} = 15k\Omega$, and R_S = source impedance of the ADC's input signal.

Conversion Time

Conversion time is calculated by:

$$t_{CONV} = (9 \times N \times 2)/f_{CLK},$$

where N is the number of channels converted. This includes one clock cycle of uncertainty. For a single channel and 5MHz clock, the conversion time is $(9 \times 1 \times 2)/5MHz = 3.6\mu s$. For the MAX155, the maximum conversion time for 8 channels is $(9 \times 8 \times 2)/5MHz = 28.8\mu s$. In the application example (Figure 10), six conversions are configured, and the conversion time is $(9 \times 6 \times 2)/5MHz = 21.6\mu s$.

8-/4-Channel ADCs with Simultaneous T/Hs and Reference

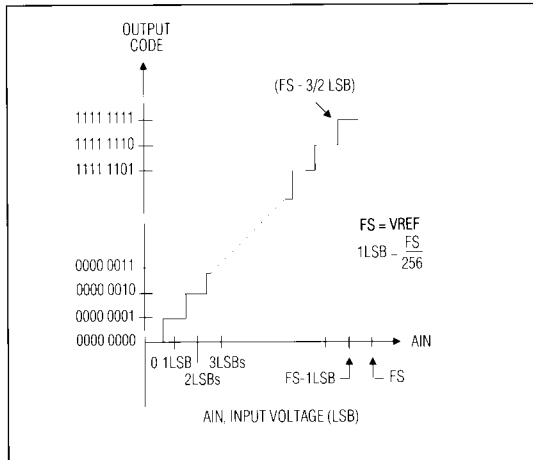

Figure 9a. Transfer Function - Unipolar Operation

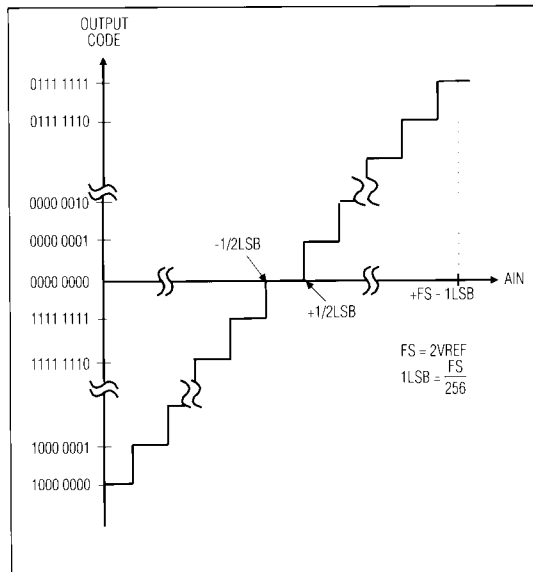

Figure 9b. Transfer Function - Bipolar Operation

Application Information

9-Bit A/D Conversion

In I/O Mode, a 9th bit of resolution can be created by performing two unipolar differential conversions with opposite input polarities (i.e. first with AIN0[+] and AIN1[-], then with AIN0[-] and AIN1[+]). Only the A0 bit must be changed to reverse input channel polarity (Table 3). The sign reversal also occurs on the current write without a one conversion delay. For a differential input signal, one of the two conversions will read 0 while the other will contain an 8-bit result. The input polarity that provides the 8-bit result indicates the 9th (sign) bit. 4 channels can be measured this way. A major drawback of this technique is that many of the sampling features of the MAX155/MAX156 are defeated since two separate samples are needed.

If only two 9-bit channels are needed, then two separate differential channels with reversed input polarities can be connected so that both input pairs sample at the same time. This way the simultaneous sampling advantages of the MAX155/MAX156 are retained.

Typical I/O Mode Application

MAX155/MAX156 address and configuration inputs for this example were determined by selecting the desired channel configurations in Tables 2 and 3. Figure 10 illustrates the configuration outlined in Table 5.

Table 5. Typical Multiplexer Configuration

A2	A1	A0	DIFF	BIP	FUNCTION
0	0	1	1	1	Channel (1, 0), Differential, Bipolar
0	1	0	0	0	Channel 2, Single-Ended, Unipolar
0	1	1	0	1	Channel 3, Single-Ended, Bipolar
1	0	0	0	1	Channel 4, Single-Ended, Bipolar
1	0	1	0	0	Channel 5, Single-Ended, Unipolar
1	1	0	1	0	Channel (6, 7), Differential, Unipolar

8-/4-Channel ADCs with Simultaneous T/Hs and Reference

An A/D conversion in I/O Mode involves the following three steps:

1. Configure the mux by loading data into the configuration register based on selections from Table 2 and/or 3 (with $\text{INH} = 1$ and $\text{MODE} = \text{open circuit}$). For this example, 6 write operations (with each address and data setting in Table 5 above) load the mux after power-up.
2. Sample all selected channels with a $\overline{\text{WR}}$ pulse (and $\text{INH} = 0$), and update or rewrite any one location of the configuration register.

This write operation may be skipped by loading INH with a 0 on the last $\overline{\text{WR}}$ of the above step. The conversion then starts on the 6th $\overline{\text{WR}}$. DIFF and BIP cannot be changed on the 6th $\overline{\text{WR}}$ if the conversion is started at that time.

When the conversion starts, $\overline{\text{BUSY}}$ goes low while all selected channels are sequentially converted. Conversion results are stored in RAM and are ready to read when $\overline{\text{BUSY}}$ returns high.

3. Data is read from RAM with $\text{INH} = \text{L}$ and consecutive RD strobes. Note that in the 6 channel configurations described in this example (Figure 10), 6 RD pulses access all available data, starting with the differential channel (1,0). Additional RD pulses loop around, accessing the lowest channel data again.
4. To start a new conversion cycle with the same mux configuration, repeat steps 2 and 3.

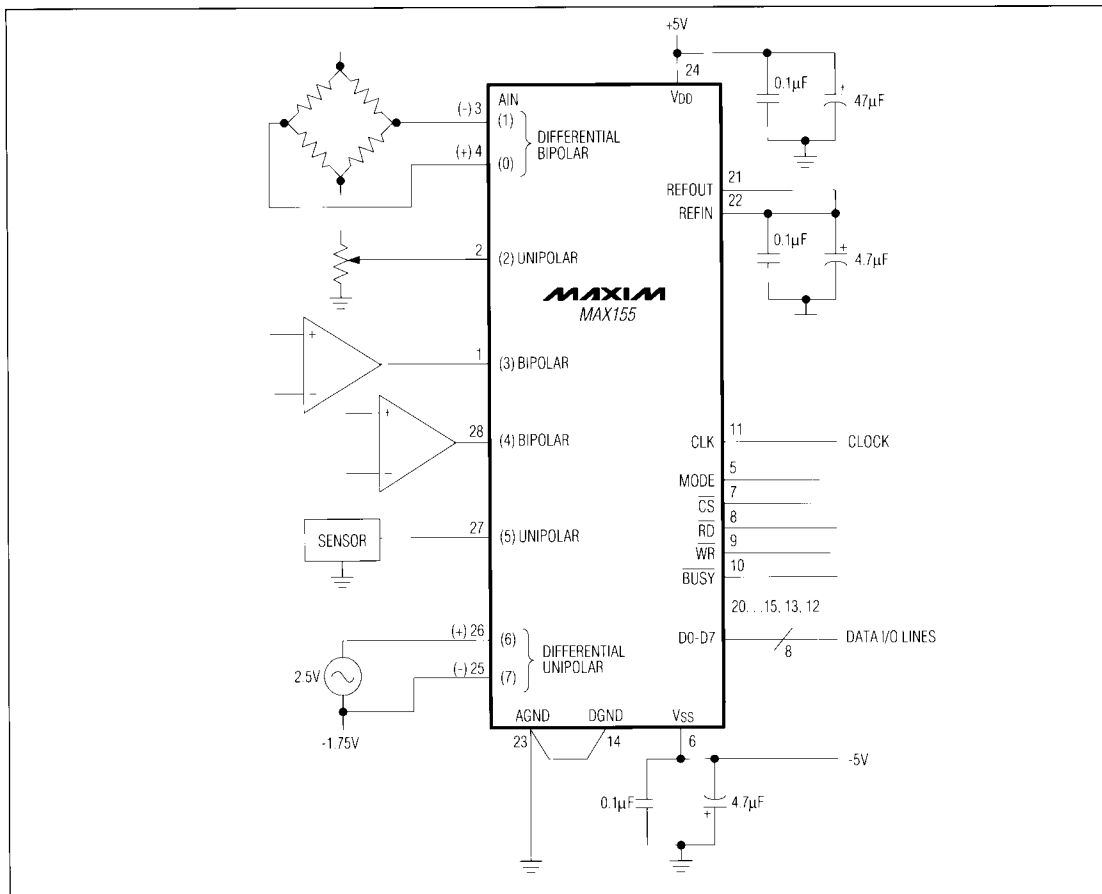

Figure 10. MAX155/MAX156 Typical Operating Circuit

8-/4-Channel ADCs with Simultaneous T/Hs and Reference

MAX155/MAX156

Ordering Information (continued)

PART	TEMP. RANGE	PIN-PACKAGE	ERROR (LSBs)
MAX155AEPI	-40°C to +85°C	28 Plastic DIP	±1/2
MAX155BEPI	-40°C to +85°C	28 Plastic DIP	±1
MAX155AEWI	-40°C to +85°C	28 Wide SO	±1/2
MAX155BEWI	-40°C to +85°C	28 Wide SO	±1
MAX155AMJI	-55°C to +125°C	28 CERDIP**	±1/2
MAX155BMJI	-55°C to +125°C	28 CERDIP**	±1
MAX156ACNG	0°C to +70°C	24 Plastic DIP†	±1/2
MAX156BCNG	0°C to +70°C	24 Plastic DIP†	±1
MAX156ACWI	0°C to +70°C	28 Wide SO	±1/2
MAX156BCWI	0°C to +70°C	28 Wide SO	±1
MAX156BC/D	0°C to +70°C	Dice*	±1
MAX156AENG	-40°C to +85°C	24 Plastic DIP†	±1/2
MAX156BENG	-40°C to +85°C	24 Plastic DIP†	±1
MAX156AEWI	-40°C to +85°C	28 Wide SO	±1/2
MAX156BEWI	-40°C to +85°C	28 Wide SO	±1

* Contact factory for dice specifications.

** Contact factory for availability and processing to MIL-STD-883.

† Narrow

Pin Configurations (continued)

TOP VIEW

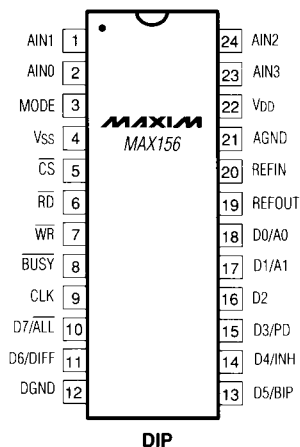

DIP

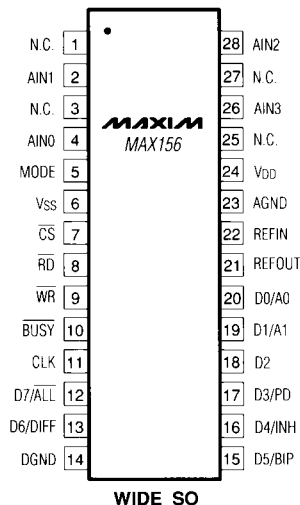

WIDE SO

8-/4-Channel ADCs with Simultaneous T/Hs and Reference

Chip Topography

MAX155/MAX156

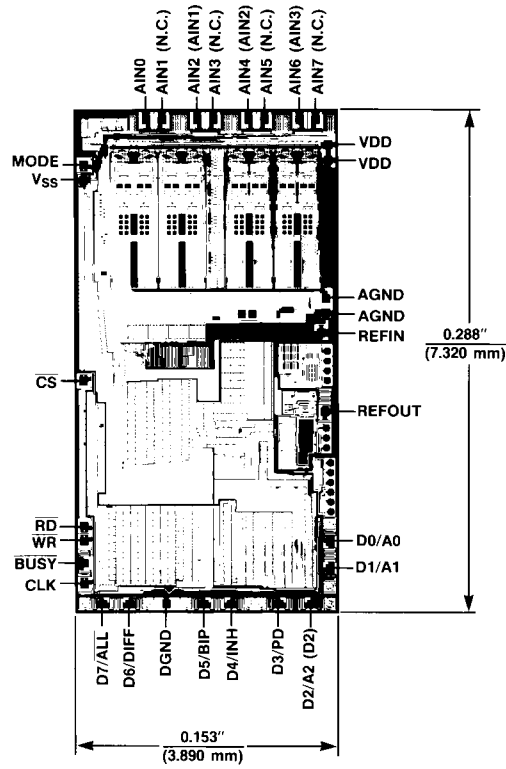

NOTE: LABELS IN () ARE FOR MAX156.

8-/4-Channel ADCs with Simultaneous T/Hs and Reference

Package Information

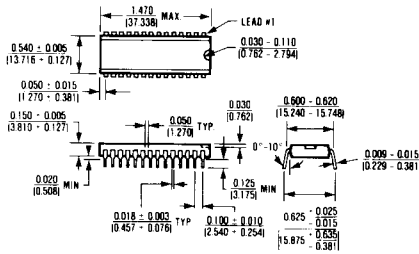

28 Lead Plastic DIP (PI)

$\theta_{JA} = 110^{\circ}\text{C/W}$
 $\theta_{JC} = 50^{\circ}\text{C/W}$

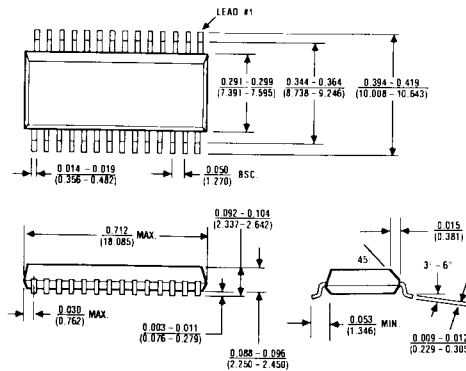

28 Lead Small Outline, Wide (WI)

$\theta_{JA} = 80^{\circ}\text{C/W}$
 $\theta_{JC} = 45^{\circ}\text{C/W}$

Maxim cannot assume responsibility for use of any circuitry other than circuitry entirely embodied in a Maxim product. No circuit patent licenses are implied. Maxim reserves the right to change the circuitry and specifications without notice at any time.

20 Maxim Integrated Products, 120 San Gabriel Drive, Sunnyvale, CA 94086 (408) 737-7600