

PLEASE CHECK WWW.MOLEX.COM FOR LATEST PART INFORMATION

Part Number: [0878320609](#)
Status: **Active**
Overview: milligrid
Description: 2.00mm (.079") Pitch Milli-Grid™ Header, Surface Mount, Vertical, Shrouded, Lead-free, 6 Circuits, 0.76µm (30µ") Gold (Au) Plating, with Locking Window, Pick-and-Place Cap, PCB Locator, Tube

Documents:

[3D Model](#) [Product Specification PS-87831-027 \(PDF\)](#)
[Drawing \(PDF\)](#) [RoHS Certificate of Compliance \(PDF\)](#)

Agency Certification

CSA LR19980
 UL E29179

General

Product Family PCB Headers
 Series [87832](#)
 Application Wire-to-Board
 Comments With Cap|Contact Molex for application in automotive industry
 Overview [milligrid](#)
 Product Name Milli-Grid™

Physical

Breakaway No
 Circuits (Loaded) 6
 Circuits (maximum) 6
 Color - Resin Black
 First Mate / Last Break No
 Flammability 94V-0
 Glow-Wire Compliant No
 Guide to Mating Part No
 Keying to Mating Part Yes
 Lock to Mating Part Yes
 Material - Metal Phosphor Bronze
 Material - Plating Mating Gold
 Material - Plating Termination Tin
 Material - Resin Nylon
 Number of Rows 2
 Orientation Vertical
 PCB Locator Yes
 PCB Retention None
 Packaging Type Tube
 Pitch - Mating Interface (in) 0.079 In
 Pitch - Mating Interface (mm) 2.00 mm
 Pitch - Term. Interface (in) 0.079 In
 Pitch - Term. Interface (mm) 2.00 mm
 Plating min: Mating (µin) 30
 Plating min: Mating (µm) 0.76
 Plating min: Termination (µin) 75
 Plating min: Termination (µm) 1.88
 Polarized to Mating Part Side Slots (2)
 Polarized to PCB No
 Shrouded Fully
 Stackable No



image - Reference only

EU RoHS

ELV and RoHS Compliant
REACH SVHC Contains SVHC: No
Halogen-Free Status

China RoHS



Need more information on product environmental compliance?

Email productcompliance@molex.com
 For a multiple part number RoHS Certificate of Compliance, [click here](#)

Please visit the [Contact Us](#) section for any non-product compliance questions.

Search Parts in this Series

[87832Series](#)

Mates With

[50394](#) Wire-to-Board Terminals. [51110](#) Wire-to-Board Crimp Housing. [87568](#) Wire-to-Board IDT Housings. [79107](#) Board-to-Board Top Entry Through Hole Receptacle. [79108](#) Board-to-Board FFC/FPC Top Entry Through Hole Receptacle. L

Temperature Range - Operating -55°C to +105°C
Termination Interface: Style Surface Mount

Electrical

Current - Maximum per Contact 2A
Voltage - Maximum 125V

Solder Process Data

Duration at Max. Process Temperature (seconds) 10
Lead-free Process Capability Reflow Capable (SMT only)
Max. Cycles at Max. Process Temperature 1
Process Temperature max. C 260

Material Info

Reference - Drawing Numbers

Product Specification PS-87831-027
Sales Drawing SD-87832-011

This document was generated on 05/25/2010

PLEASE CHECK WWW.MOLEX.COM FOR LATEST PART INFORMATION

PEG OPTION	P/N WITH CAP IN TAPE & REEL	P/N WITH CAP IN TUBE	P/N WITHOUT CAP IN TUBE	CKT SIZE	DIMENSION				
					A	B	C	D	P
NO	87832-0407	87832-0409	87832-0411	4	2.00	4.85	6.65	5.00	-
YES	87832-0607	87832-0609	87832-0611	6	4.00	6.85	8.65	7.00	2.00
YES	87832-0807	87832-0809	87832-0811	8	6.00	8.85	10.65	9.00	4.00
YES	87832-1007	87832-1009	87832-1011	10	8.00	10.85	12.65	11.00	6.00
YES	87832-1207	87832-1209	87832-1211	12	10.00	12.85	14.65	13.00	8.00

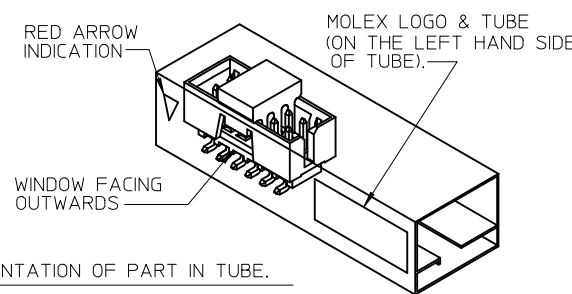
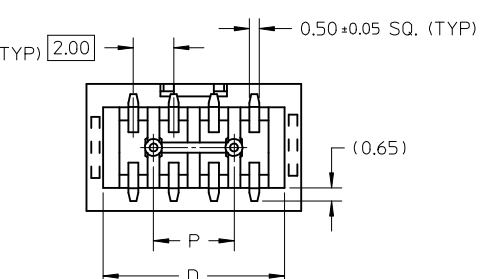
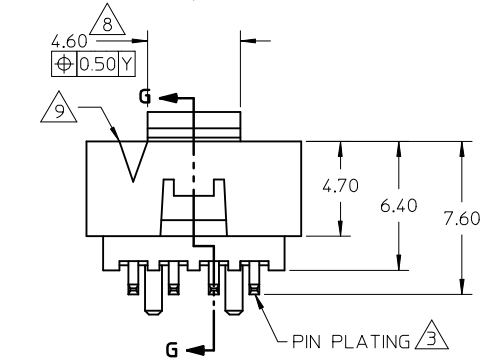
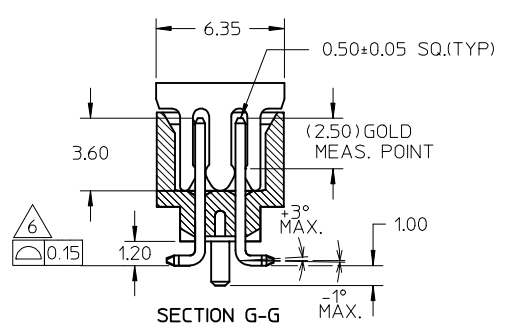
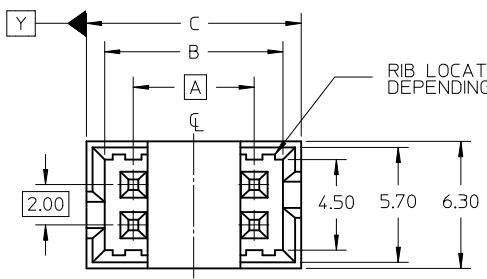

REF : ORIENTATION OF PART IN TUBE.
(FOR THE REFERENCE OF PART/TUBE ASSEMBLY.)

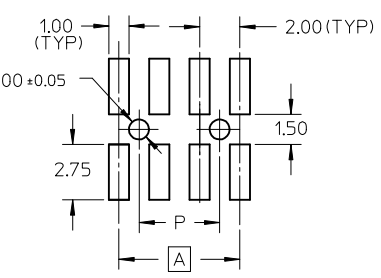

NOTES:

- FOR ILLUSTRATION PURPOSES, 8 CIRCUIT SIZE WAFER IS SHOWN.
- MATERIAL :
HOUSING & CAP : 30% G.F., NYLON 46, UL94V-0, COLOR BLACK.
PIN : 0.50MM SQ.PHOSPHOR BRONZE.
- PLATING :
0.76um/30uin GOLD IN CONTACT AREA AND 1.88um/75uin MIN.TIN IN SOLDER TAIL AREA OVER 1.27um/50uin MIN, NICKEL OVERALL.
- PIN PUSHOUT FORCE : 0.91 KG MIN. IN EITHER DIRECTION.
- PRODUCT SPECIFICATION PS-87831-027 APPLIES.
- COPLANARITY IS TO BE MEASURED BY RESTING THE SOLDER TAIL ON A GAUGE SURFACE.
- BEND DEPRESSION ON SMT TAIL IS ACCEPTABLE SO LONG AS IT DOES NOT AFFECT THE OVERALL COPLANARITY OF THE TAIL.
- CAP TO BE POSITION IN THE CENTER OF HEADER FOR PICK AND PLACE.
- CKT 4 & 6 HAS NO IDENTIFICATION TAG.
- THIS HEADER MATES WITH MOLEX:
a) CRIMP RECEPTACLE HOUSING, 51110 SERIES WITH CRIMP TERMINAL, 50394 SERIES.
b) 2MM MILLIGRID DUAL ROW IDT, 87568 SERIES.
- NO CENTRE POLARIZATION SLOT FOR CKT SIZE 4 AND 6.

ADD IN NOTES NO.11 EC NO: S2009-0943 DRWN:YCHONG CHKD:SKANG APPR:MLONG	QUALITY SYMBOLS ▽=0 ◻=0	GENERAL TOLERANCES (UNLESS SPECIFIED)		DIMENSION STYLE MM ONLY	SCALE NTS	DESIGN UNITS METRIC	THIRD ANGLE PROJECTION	
		mm	INCH	DRAWN BY ATSEE	DATE 2003/10/15	TITLE MGRID, SHROUDED HEADER W/PEGS/CAP/LOCK FEATURE IN TUBE AND T&R, SMT		
		4 PLACES ± --- ± ---	3 PLACES ± --- ± ---	CHECKED BY KCLING	DATE 2003/11/07	MOLEX INCORPORATED		
		2 PLACES ± 0.2 ± ---	1 PLACE ± --- ± ---	APPROVED BY SKTOH	DATE 2003/11/07	DOCUMENT NO. SD-87832-011		
A5	REV	DRAFT WHERE APPLICABLE MUST REMAIN WITHIN DIMENSIONS		SIZE A3	SHEET NO. 1 OF 2			
				THIS DRAWING CONTAINS INFORMATION THAT IS PROPRIETARY TO MOLEX INCORPORATED AND SHOULD NOT BE USED WITHOUT WRITTEN PERMISSION				

10 9 8 7 6 5 4 3 2 1

WITH CAP
TUBE PACKAGING

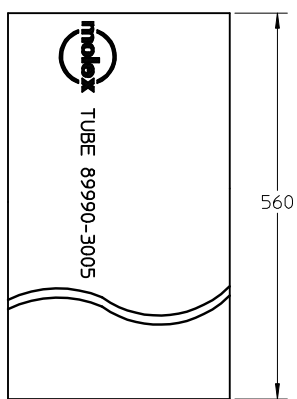

WITHOUT CAP
TUBE PACKAGING

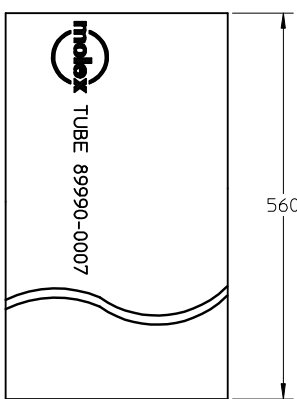

P/N WITH CAP IN T&R	CKT SIZE	F	Bo	So	W
87832-0407	04	7.50	7.15	-	16.00
87832-0607	06	11.50	9.15	-	24.00
87832-0807	08	11.50	11.05	-	24.00
87832-1007	10	11.50	13.05	-	24.00
87832-1207	12	14.20	15.15	28.40	32.00

EMBOSSED CARRIER TAPE 'A'

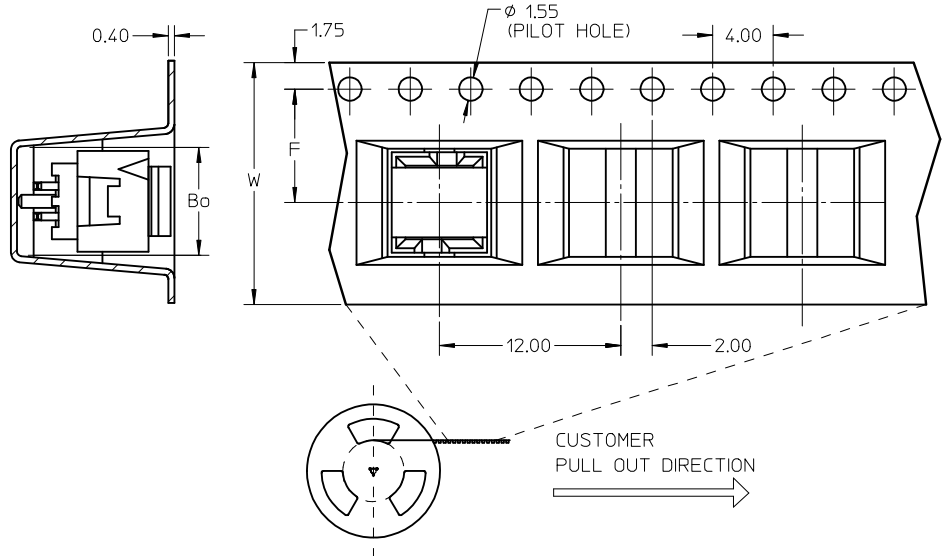

TUBE P/N: 89990-3005

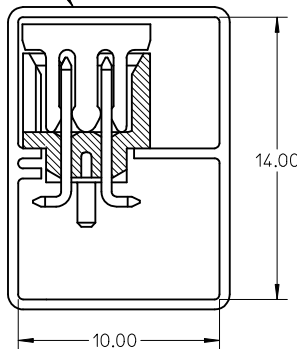

TUBE P/N: 89990-0007

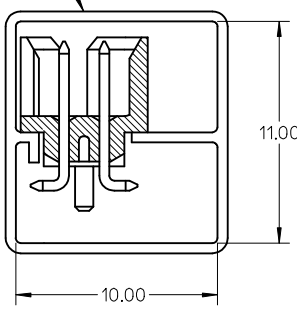

NOTES:

1. LEADER AND TRAILER TAPE

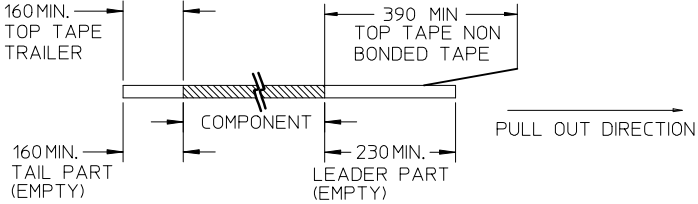

2. PEELING OFF FORCE OF THE TOP TAPE: 20-80gf.
(PEELING DIRECTION AS SHOWN IN FOLLOWING FIGURE)

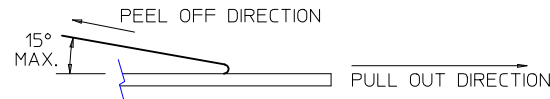

3. PACKAGING STANDARD IS AS PER EIA-481.

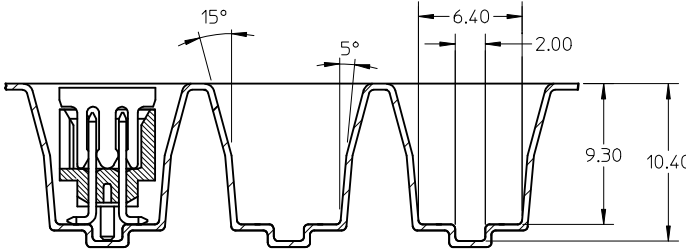

ADD IN UNIVERSITY NO.11 EC NO: S2009-0943 DRWN: YMC HONG CHKD: SKANG APPR: MLONG	2009/07/01 2009/07/08 2009/07/16	DESCRIPTION REV	QUALITY SYMBOLS ▽=0 ◻=0	GENERAL TOLERANCES (UNLESS SPECIFIED) mm INCH 4 PLACES ± --- ± --- 3 PLACES ± --- ± --- 2 PLACES ± 0.2 ± --- 1 PLACE ± --- ± --- ANGULAR ± 3 °	DIMENSION STYLE MM ONLY DRAWN BY ATSEE CHECKED BY KCL ING APPROVED BY SKTOH MATERIAL NO. SKTOH	DATE 2003/10/15 2003/11/07 2003/11/07	SCALE NTS	DESIGN UNITS METRIC	THIRD ANGLE PROJECTION	TITLE MGRID, SHROUDED HEADER W/PEGS/CAP/LOCK FEATURE IN TUBE AND T&R, SMT MOLEX INCORPORATED DOCUMENT NO. SD-87832-011	SHEET NO. 2 OF 2			
			DRAFT WHERE APPLICABLE MUST REMAIN WITHIN DIMENSIONS	SIZE A3	THIS DRAWING CONTAINS INFORMATION THAT IS PROPRIETARY TO MOLEX INCORPORATED AND SHOULD NOT BE USED WITHOUT WRITTEN PERMISSION									

9 8 7 6 5 4 3 2 1