

## Resistor Networks

**BOURNS®**

I.	Product Selection Guide.....	278
II.	Popular Resistance Codes.....	284
III.	Thick Film Products	
	Through-hole Packages	
	Molded DIPs.....	286
	Molded SIPs.....	288
	Conformal SIPs.....	294
	Surface Mount Packages	
	Wide Body.....	300
	Medium Body.....	302
	Ordering Guide.....	304
	RC Networks	
	T-Filters (EMI/RFI Low-Pass Filters).....	305
	RC Terminators.....	307
	ECL Terminators.....	309
	Capacitor Networks.....	312
IV.	Precision Thin-Film-on-Ceramic Products	
	Through-hole Packages.....	313
	Surface Mount Packages.....	318
VI.	Designer's Guide and Application Notes	
	EMI/RFI Filters.....	320
	RC Terminator Networks.....	322
	Emitter Coupled Logic Terminators.....	324
	Dual Terminator Resistor Networks.....	326
	SCSI.....	327
	R/2R Ladder Networks.....	330
	DRAM Applications.....	331
	Thin Film Applications.....	334
	Soldering and Cleaning Processes.....	336

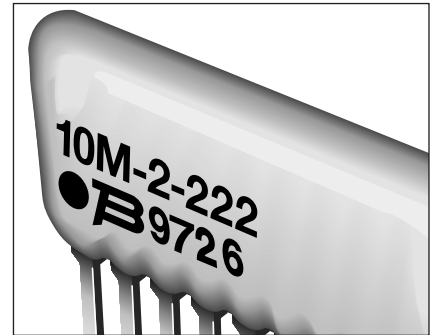

*For a complete listing of thick film products in stock and readily available through distribution, see page 284.*



# Resistor Networks Product Selection Guide

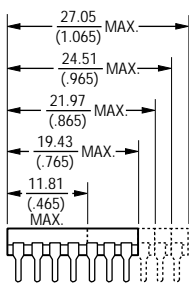

## Thick Film, Molded DIPs

Package Type	Series Number	Pin Ct.	Isolated Resistors	Bussed Resistors	Dual Terminators	Page No.
Molded DIP Low Profile  4.70 (.185) Seated Height	4100R	8	4108R-1-RC	4108R-2-RC	4108R-3-RC/RC	286
		14	4114R-1-RC	4114R-2-RC	4114R-3-RC/RC	
		16	4116R-1-RC	4116R-2-RC	4116R-3-RC/RC	
		18	4118R-1-RC	4118R-2-RC	4118R-3-RC/RC	
		20	4120R-1-RC	4120R-2-RC	4120R-3-RC/RC	

## Thick Film, Molded SIPs

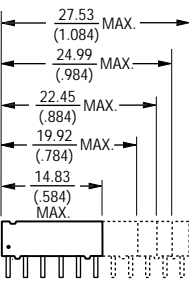
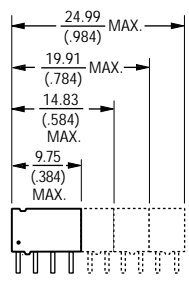
Package Type	Series Number	Pin Ct.	Isolated Resistors	Bussed Resistors	Dual Terminators	Page No.
Molded SIP Low Profile  4.96 (.195) Seated Height	4300R	6	4306R-102-RC	4306R-101-RC	4306R-104-RC/RC	288
		8	4308R-102-RC	4308R-101-RC	4308R-104-RC/RC	
		9		4309R-101-RC	4309R-104-RC/RC	
		10	4310R-102-RC	4310R-101-RC	4310R-104-RC/RC	
		11		4311R-101-RC	4311R-104-RC/RC	
Molded SIP Medium Profile  6.35 (.250) Seated Height	4300M	4	4304M-102-RC	4304M-101-RC	4304M-104-RC/RC	290
		6	4306M-102-RC	4306M-101-RC	4306M-104-RC/RC	
		8	4308M-102-RC	4308M-101-RC	4308M-104-RC/RC	
		10	4310M-102-RC	4310M-101-RC	4310M-104-RC/RC	

# Resistor Networks Product Selection Guide

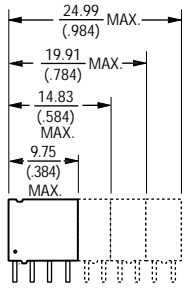

## Thick Film, Molded SIPs (continued)

Package Type	Series Number	Pin Ct.	Isolated Resistors	Bussed Resistors	Dual Terminators	Page No.
Molded SIP High Profile 	4300H	4	4304H-102-RC	4304H-101-RC	4304H-104-RC/RC	292
		6	4306H-102-RC	4306H-101-RC	4306H-104-RC/RC	
		8	4308H-102-RC	4308H-101-RC	4308H-104-RC/RC	
		10	4310H-102-RC	4310H-101-RC	4310H-104-RC/RC	

## Thick Film, Conformal SIPs

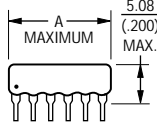
Package Type	Series Number	Pin Ct.	Isolated Resistors	Bussed Resistors	Dual Terminators	Page No.																												
Conformal SIP Low Profile  <p>5.08 (.200) Seated Height</p> <table border="1" data-bbox="181 1396 373 1648"> <thead> <tr> <th>Pin Count</th> <th>A Maximum mm (Inches)</th> </tr> </thead> <tbody> <tr><td>4</td><td>10.11 (.398)</td></tr> <tr><td>5</td><td>12.65 (.498)</td></tr> <tr><td>6</td><td>15.19 (.598)</td></tr> <tr><td>7</td><td>17.73 (.698)</td></tr> <tr><td>8</td><td>20.27 (.798)</td></tr> <tr><td>9</td><td>22.81 (.898)</td></tr> <tr><td>10</td><td>25.35 (.998)</td></tr> <tr><td>11</td><td>27.89 (1.098)</td></tr> <tr><td>12</td><td>30.43 (1.198)</td></tr> <tr><td>13</td><td>32.97 (1.298)</td></tr> <tr><td>14</td><td>35.51 (1.398)</td></tr> <tr><td>15</td><td>38.05 (1.498)</td></tr> <tr><td>16</td><td>40.59 (1.598)</td></tr> </tbody> </table> <p>Industrial Grade</p>	Pin Count	A Maximum mm (Inches)	4	10.11 (.398)	5	12.65 (.498)	6	15.19 (.598)	7	17.73 (.698)	8	20.27 (.798)	9	22.81 (.898)	10	25.35 (.998)	11	27.89 (1.098)	12	30.43 (1.198)	13	32.97 (1.298)	14	35.51 (1.398)	15	38.05 (1.498)	16	40.59 (1.598)	4600X	4	4604X-102-RC	4604X-101-RC	4604X-104-RC/RC	294
	Pin Count	A Maximum mm (Inches)																																
	4	10.11 (.398)																																
	5	12.65 (.498)																																
	6	15.19 (.598)																																
	7	17.73 (.698)																																
	8	20.27 (.798)																																
	9	22.81 (.898)																																
	10	25.35 (.998)																																
	11	27.89 (1.098)																																
	12	30.43 (1.198)																																
	13	32.97 (1.298)																																
	14	35.51 (1.398)																																
	15	38.05 (1.498)																																
16	40.59 (1.598)																																	
5		4605X-101-RC	4605X-104-RC/RC																															
6	4606X-102-RC	4606X-101-RC	4606X-104-RC/RC																															
7		4607X-101-RC	4607X-104-RC/RC																															
8	4608X-102-RC	4608X-101-RC	4608X-104-RC/RC																															
9		4609X-101-RC	4609X-104-RC/RC																															
10	4610X-102-RC	4610X-101-RC	4610X-104-RC/RC																															
11		4611X-101-RC	4611X-104-RC/RC																															
12	4612X-102-RC	4612X-101-RC	4612X-104-RC/RC																															
13		4613X-101-RC	4613X-104-RC/RC																															
14	4614X-102-RC	4614X-101-RC	4614X-104-RC/RC																															

# Resistor Networks Product Selection Guide

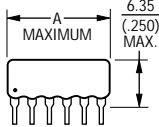
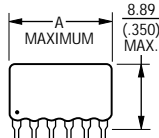

## Thick Film, Conformal SIPs (continued)

Package Type	Series Number	Pin Ct.	Isolated Resistors	Bussed Resistors	Dual Terminators	Page No.																												
Conformal SIP Medium Profile  6.35 (.250) Seated Height <table border="1" data-bbox="159 724 349 976"> <thead> <tr> <th>Pin Count</th> <th>A Maximum mm (Inches)</th> </tr> </thead> <tbody> <tr><td>4</td><td>10.11 (.398)</td></tr> <tr><td>5</td><td>12.65 (.498)</td></tr> <tr><td>6</td><td>15.19 (.598)</td></tr> <tr><td>7</td><td>17.73 (.698)</td></tr> <tr><td>8</td><td>20.27 (.798)</td></tr> <tr><td>9</td><td>22.81 (.898)</td></tr> <tr><td>10</td><td>25.35 (.998)</td></tr> <tr><td>11</td><td>27.89 (1.098)</td></tr> <tr><td>12</td><td>30.43 (1.198)</td></tr> <tr><td>13</td><td>32.97 (1.298)</td></tr> <tr><td>14</td><td>35.51 (1.398)</td></tr> <tr><td>15</td><td>38.05 (1.498)</td></tr> <tr><td>16</td><td>40.59 (1.598)</td></tr> </tbody> </table> Industrial Grade	Pin Count	A Maximum mm (Inches)	4	10.11 (.398)	5	12.65 (.498)	6	15.19 (.598)	7	17.73 (.698)	8	20.27 (.798)	9	22.81 (.898)	10	25.35 (.998)	11	27.89 (1.098)	12	30.43 (1.198)	13	32.97 (1.298)	14	35.51 (1.398)	15	38.05 (1.498)	16	40.59 (1.598)	4600M	4	4604M-102-RC	4604M-101-RC	4604M-104-RC/RC	298
	Pin Count	A Maximum mm (Inches)																																
	4	10.11 (.398)																																
	5	12.65 (.498)																																
	6	15.19 (.598)																																
	7	17.73 (.698)																																
	8	20.27 (.798)																																
	9	22.81 (.898)																																
	10	25.35 (.998)																																
	11	27.89 (1.098)																																
	12	30.43 (1.198)																																
	13	32.97 (1.298)																																
	14	35.51 (1.398)																																
	15	38.05 (1.498)																																
16	40.59 (1.598)																																	
5		4605M-101-RC	4605M-104-RC/RC																															
6	4606M-102-RC	4606M-101-RC	4606M-104-RC/RC																															
7		4607M-101-RC	4607M-104-RC/RC																															
8	4608M-102-RC	4608M-101-RC	4608M-104-RC/RC																															
9		4609M-101-RC	4609M-104-RC/RC																															
10	4610M-102-RC	4610M-101-RC	4610M-104-RC/RC																															
11		4611M-101-RC	4611M-104-RC/RC																															
12	4612M-102-RC	4612M-101-RC	4612M-104-RC/RC																															
13		4613M-101-RC	4613M-104-RC/RC																															
14	4614M-102-RC	4614M-101-RC	4615M-104-RC/RC																															
Conformal SIP High Profile  8.89 (.350) Seated Height <table border="1" data-bbox="159 1323 349 1575"> <thead> <tr> <th>Pin Count</th> <th>A Maximum mm (Inches)</th> </tr> </thead> <tbody> <tr><td>4</td><td>10.11 (.398)</td></tr> <tr><td>5</td><td>12.65 (.498)</td></tr> <tr><td>6</td><td>15.19 (.598)</td></tr> <tr><td>7</td><td>17.73 (.698)</td></tr> <tr><td>8</td><td>20.27 (.798)</td></tr> <tr><td>9</td><td>22.81 (.898)</td></tr> <tr><td>10</td><td>25.35 (.998)</td></tr> <tr><td>11</td><td>27.89 (1.098)</td></tr> <tr><td>12</td><td>30.43 (1.198)</td></tr> <tr><td>13</td><td>32.97 (1.298)</td></tr> <tr><td>14</td><td>35.51 (1.398)</td></tr> <tr><td>15</td><td>38.05 (1.498)</td></tr> <tr><td>16</td><td>40.59 (1.598)</td></tr> </tbody> </table> Industrial Grade	Pin Count	A Maximum mm (Inches)	4	10.11 (.398)	5	12.65 (.498)	6	15.19 (.598)	7	17.73 (.698)	8	20.27 (.798)	9	22.81 (.898)	10	25.35 (.998)	11	27.89 (1.098)	12	30.43 (1.198)	13	32.97 (1.298)	14	35.51 (1.398)	15	38.05 (1.498)	16	40.59 (1.598)	4600H	4	4604H-102-RC	4604H-101-RC	4604H-104-RC/RC	296
	Pin Count	A Maximum mm (Inches)																																
	4	10.11 (.398)																																
	5	12.65 (.498)																																
	6	15.19 (.598)																																
	7	17.73 (.698)																																
	8	20.27 (.798)																																
	9	22.81 (.898)																																
	10	25.35 (.998)																																
	11	27.89 (1.098)																																
	12	30.43 (1.198)																																
	13	32.97 (1.298)																																
	14	35.51 (1.398)																																
	15	38.05 (1.498)																																
16	40.59 (1.598)																																	
5		4605H-101-RC	4605H-104-RC/RC																															
6	4606H-102-RC	4606H-101-RC	4606H-104-RC/RC																															
7		4607H-101-RC	4607H-104-RC/RC																															
8	4608H-102-RC	4608H-101-RC	4608H-104-RC/RC																															
9		4609H-101-RC	4609H-104-RC/RC																															
10	4610H-102-RC	4610H-101-RC	4610H-104-RC/RC																															
11		4611H-101-RC	4611H-104-RC/RC																															
12	4612H-102-RC	4612H-101-RC	4612H-104-RC/RC																															
13		4613H-101-RC	4613H-104-RC/RC																															
14	4614H-102-RC	4614H-101-RC	4614H-104-RC/RC																															

## Thick Film, Surface Mount Packages

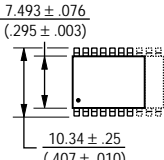
Package Type	Series Number	Pin Ct.	Isolated Resistors	Bussed Resistors	Dual Terminators	Page No.
SOL SMD 7.49mm Wide Body with Gull Wing Lead Form 	4400P	16	4416P-1-RC 4416P-4-RC	4416P-2-RC	4416P-3-RC/RC	300
		20	4420P-1-RC 4420P-4-RC	4420P-2-RC	4420P-3-RC/RC	

# Resistor Networks Product Selection Guide

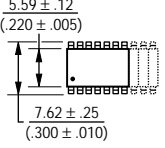

## Thick Film, Surface Mount Packages (continued)

Package Type	Series Number	Pin Ct.	Isolated Resistors	Bussed Resistors	Dual Terminators	Page No.
SOM SMD 5.59mm Medium Body with Gull Wing Lead Form  	4800P	14	4814P-1-RC	4814P-2-RC	4814P-3-RC/RC	302
		16	4816P-1-RC 4816P-4-RC	4816P-2-RC	4816P-3-RC/RC	
		18	4818P-1-RC	4818P-2-RC	4818P-3-RC/RC	
		20	4820P-1-RC 4820P-4-RC	4820P-2-RC	4820P-3-RC/RC	

## RC Networks Standard Circuits (Custom Circuits Available)

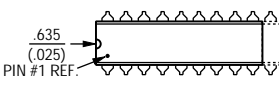
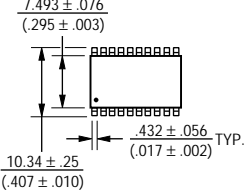
Package Type	Series Number	Pin Ct.	Capacitor Types	Capacitor Range	Circuit Type	Page No.
Molded DIP Low Profile  	4100R-601	18,20	Z5U	50pf - 200pf	T-Filter	305
SOGN SMD 7.49mm Wide Body, Gull Wing  	4400P-601	20	Z5U	50pf-200pf	T-Filter	305

# Resistor Networks Product Selection Guide



## RC Networks Standard Circuits (Custom Circuits Available) (Continued)

Package Type	Series Number	Pin Ct.	Capacitor Types	Capacitor Range	Circuit Type	Page No.
Conformal SIP High Profile 	4600H-700	4-14	NPO, X7R	39pf-100Kpf	RC Terminator	307
Conformal SIP Medium Profile 	4600M-800	4-14	X7R	39pf-100Kpf	ECL Terminator	309
Conformal SIP Medium Profile 	4600M-900	4-14	NPO, X7R	39pf-100Kpf	Isolated/Bussed	312

## Thin Film, Molded DIPs

Package Type	Series Number	Pin Ct.	Isolated Resistors	Bussed Resistors	Series Circuit	Page No.
Molded DIP 	4100T	8	4108T-1-XXXX XX			313
		14	4114T-1-XXXX XX	4114T-2-XXXX XX		
		16	4116T-1-XXXX XX	4116T-2-XXXX XX		
		18	4118T-1-XXXX XX	4118T-2-XXXX XX		
		20	4120T-1-XXXX XX	4120T-2-XXXX XX		

## Thin Film, Molded SIPs

Package Type	Series Number	Pin Ct.	Isolated Resistors	Bussed Resistors	Series Circuit	Page No.
Molded SIP Low Profile (also available in medium and high profile) 	4300T,S,K	6	4306T-102-XXXX XX	4306T-101-XXXX XX	4306T-106-XXXX XX	314
		8	4308T-102-XXXX XX	4308T-101-XXXX XX	4308T-106-XXXX XX	
		9		4309T-101-XXXX XX	4309T-106-XXXX XX	
		10	4310T-102-XXXX XX	4310T-101-XXXX XX	4310T-106-XXXX XX	
		11		4311T-101-XXXX XX	4311T-106-XXXX XX	

# Resistor Networks Product Selection Guide



## Thin Film, Conformal SIPs

Package Type	Series Number	Pin Ct.	Isolated Resistors	Bussed Resistors	Series Circuit	Page No.																												
Conformal SIP Low Profile (also available in medium and high profile)  <table border="1"> <thead> <tr> <th>Pin Count</th> <th>A Maximum mm (Inches)</th> </tr> </thead> <tbody> <tr><td>4</td><td>10.11 (.398)</td></tr> <tr><td>5</td><td>12.65 (.498)</td></tr> <tr><td>6</td><td>15.19 (.598)</td></tr> <tr><td>7</td><td>17.73 (.698)</td></tr> <tr><td>8</td><td>20.27 (.798)</td></tr> <tr><td>9</td><td>22.81 (.898)</td></tr> <tr><td>10</td><td>25.35 (.998)</td></tr> <tr><td>11</td><td>27.89 (1.098)</td></tr> <tr><td>12</td><td>30.43 (1.198)</td></tr> <tr><td>13</td><td>32.97 (1.298)</td></tr> <tr><td>14</td><td>35.51 (1.398)</td></tr> <tr><td>15</td><td>38.05 (1.498)</td></tr> <tr><td>16</td><td>40.59 (1.598)</td></tr> </tbody> </table>	Pin Count	A Maximum mm (Inches)	4	10.11 (.398)	5	12.65 (.498)	6	15.19 (.598)	7	17.73 (.698)	8	20.27 (.798)	9	22.81 (.898)	10	25.35 (.998)	11	27.89 (1.098)	12	30.43 (1.198)	13	32.97 (1.298)	14	35.51 (1.398)	15	38.05 (1.498)	16	40.59 (1.598)	4600T,S,K	4	4604T-102-XXXX XX	4604T-101-XXXX XX	4604T-106-XXXX XX	316
	Pin Count	A Maximum mm (Inches)																																
	4	10.11 (.398)																																
	5	12.65 (.498)																																
	6	15.19 (.598)																																
	7	17.73 (.698)																																
	8	20.27 (.798)																																
	9	22.81 (.898)																																
	10	25.35 (.998)																																
	11	27.89 (1.098)																																
	12	30.43 (1.198)																																
	13	32.97 (1.298)																																
	14	35.51 (1.398)																																
	15	38.05 (1.498)																																
	16	40.59 (1.598)																																
	5		4605T-101-XXXX XX	4605T-106-XXXX XX																														
6	4606T-102-XXXX XX	4606T-101-XXXX XX	4606T-106-XXXX XX																															
7		4607T-101-XXXX XX	4607T-106-XXXX XX																															
8	4608T-102-XXXX XX	4608T-101-XXXX XX	4608T-106-XXXX XX																															
9		4609T-101-XXXX XX	4609T-106-XXXX XX																															
10	4610T-102-XXXX XX	4610T-101-XXXX XX	4610T-106-XXXX XX																															
11		4611T-101-XXXX XX	4611T-106-XXXX XX																															
12	4612T-102-XXXX XX	4612T-101-XXXX XX	4612T-106-XXXX XX																															
13		4613T-101-XXXX XX	4613T-106-XXXX XX																															
14	4614T-102-XXXX XX	4614T-101-XXXX XX	4614T-106-XXXX XX																															
15		4615T-101-XXXX XX	4615T-106-XXXX XX																															
16	4616T-102-XXXX XX	4616T-101-XXXX XX	4616T-106-XXXX XX																															

## Thin Film, Surface Mount Packages

Package Type	Series Number	Pin Ct.	Isolated Resistors	Bussed Resistors	Series Circuit	Page No.
SOL SMD Wide Body Gull Wing 	4400T	16	4416T-1-XXXX XX	4416T-2-XXXX XX		318
		20	4420T-1-XXXX XX	4420T-2-XXXX XX		
SOM SMD Medium Body Gull Wing 	4800T	14	4814T-1-XXXX XX	4814T-2-XXXX XX		319
		16	4816T-1-XXXX XX	4816T-2-XXXX XX		
		18	4818T-1-XXXX XX	4818T-2-XXXX XX		
		20	4820T-1-XXXX XX	4820T-2-XXXX XX		

# Resistor Networks Popular Resistance Codes



Part Number	Resistance Codes
4114R-1-	102 221 331 472 103 271 151
4114R-2-	102 472 103 104
4114R-3-	221/331
4116R-1-	101 202 330 470 560 681 102 220 331 471 103 221 332 472 104 222 391 473 105 223 121 224 122 270 151 271 152
4116R-2-	102 222 472 562 103 104
4116R-3-	221/331
4306R-101-	101 222 472 102 271 103 104
4306R-102-	103
4308R-101-	101 222 470 102 471 103 472 104 473 151
4308R-102-	101 220 330 470 680 820 102 221 331 471 103 223 390 472 104 271 391 121
4308R-104-	221/331 331/471
4310R-101-	101 203 331 471 562 102 221 332 472 103 222 333 473 104 223 391 121 151
4310R-102-	101 220 330 470 102 270 471 103 472 104 152
4310R-104-	221/331 331/471

Part Number	Resistance Codes
4416P-1-	470
4416P-2-	103
4416P-T01-	470
4416P-T02-	1034420P-1- 102 470
4420P-002-	103 472
4420P-T01-	102 470
4420P-T02-	103 472
4606X-101-	102 222 331 471 103 223 472 104 272 473
4606X-102	102 473 103
4608X-101-	102 222 331 472 561 103 332 473 104
4608X-102-	101 202 330 470 560 681 822 102 220 331 471 824 103 221 333 472 104 222 390 473 105 223 121 224 152 271
4608X-104-	221/331 331/471
4610X-101-	101 203 331 471 561 202 102 221 332 472 562 333 103 222 392 473 681 104 223 474 122 105 224 151 271 152 272
4610X-102-	101 220 330 470 560 102 472 103 473 104 105 151
4610X-104-	221/331 331/471



## Resistor Networks Popular Resistance Codes

**BOURNS®**

Part Number	Resistance Codes
4814P-1-	220
4814P-2-	103 203 331 472
4814P-T01-	103 220
4814P-T02-	103 203 331 472
4816P-1-	101 220 330 470 560 680 820 102 222 331 472 103 223 104 271 152
4816P-2-	101 222 472 102 473 103
4816P-T01-	101 220 330 470 560 680 820 102 222 331 472 103 223 104 271 152
4816P-T02-	101 222 472 102 473 103

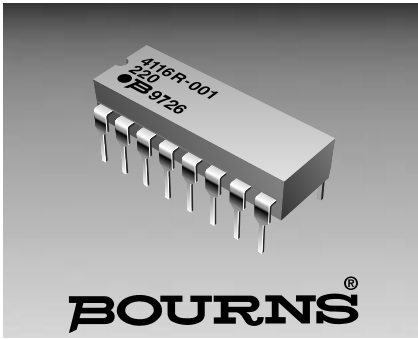

## Features

- Compatible with automatic insertion equipment
- Superior package integrity
- Marking on contrasting background for permanent identification

# 4100R Series - Thick Film Molded DIPs

### Product Characteristics

Resistance Range .....10 ohms to 10 megohms  
 Maximum Operating Voltage.....100V  
 Temperature Coefficient of Resistance  
 50Ω to 2.2 MΩ.....±100ppm/°C  
 below 50Ω.....±250ppm/°C  
 above 2.2 MΩ.....±250ppm/°C  
 TCR Tracking .....50ppm/°C  
 maximum; equal values  
 Resistor Tolerance .....See circuits  
 Operating Temperature .....-55°C to +125°C  
 Insulation Resistance .....10,000 megohms minimum  
 Dielectric Withstanding Voltage .....200 VRMS  
 Lead Solderability .....Meet requirements of MIL-STD-202 Method 208

### Environmental Characteristics

TESTS PER MIL-STD-202.....ΔR MAX.  
 Short Time Overload.....±0.25%  
 Load Life.....±1.00%  
 Moisture Resistance.....±0.50%  
 Resistance to Soldering Heat .....±0.25%  
 Terminal Strength.....±0.25%  
 Thermal Shock.....±0.25%

### Physical Characteristics

Flammability .....Conforms to UL94V-0  
 Lead Frame Material .....Copper, solder coated  
 Body Material .....Novolac epoxy

### How To Order

**41 14 R - 1 - 152**

Model (41 = Molded DIP)  
 Number of Pins  
 Physical Configuration (R = Thick Film Low Profile)  
 Electrical Configuration  
 • 1 = Isolated  
 • 2 = Bussed  
 • 3 = Dual Terminator

Resistance Code  
 • First 2 digits are significant  
 • Third digit represents the number of zeros to follow.

Consult factory for other available options.

### Package Power Temp. Derating Curve

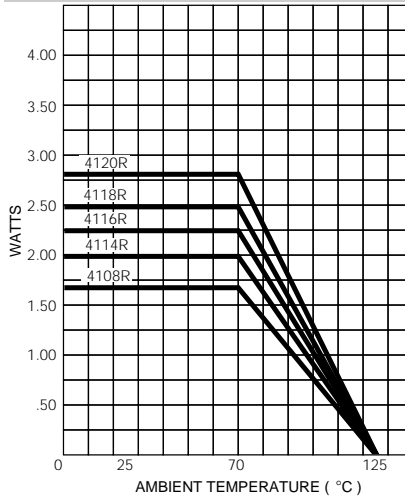

### Package Power Rating at 70°C

4108R	1.69 watts
4114R	2.00 watts
4116R	2.25 watts
4118R	2.50 watts
4120R	2.80 watts

### Typical Part Marking

Represents total content. Layout may vary.

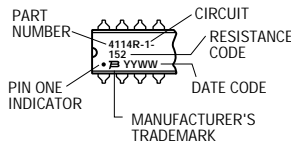

### Product Dimensions

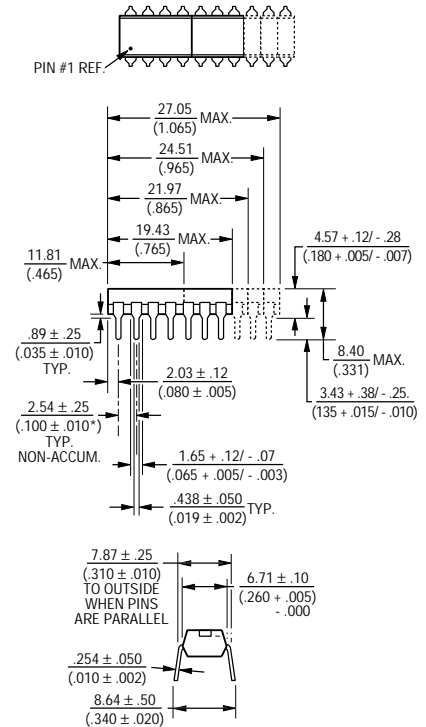

Governing dimensions are in metric. Dimensions in parentheses are inches and are approximate.

\*Terminal centerline to centerline measurements made at point of emergence of the lead from the body.

# 4100R Series - Thick Film Molded DIPs



### Isolated Resistors (1 Circuit)

- Model 4108R-1-RC (4 Isolated Resistors)
- Model 4114R-1-RC (7 Isolated Resistors)
- Model 4116R-1-RC (8 Isolated Resistors)
- Model 4118R-1-RC (9 Isolated Resistors)
- Model 4120R-1-RC (10 Isolated Resistors)

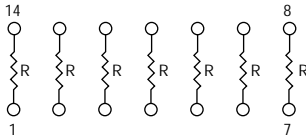

### Bussed Resistors (2 Circuit)

- Model 4108R-2-RC (7 Resistors, Pin 8 Common)
- Model 4114R-2-RC (13 Resistors, Pin 14 Common)
- Model 4116R-2-RC (15 Resistors, Pin 16 Common)
- Model 4118R-2-RC (17 Resistors, Pin 18 Common)
- Model 4120R-2-RC (19 Resistors, Pin 20 Common)

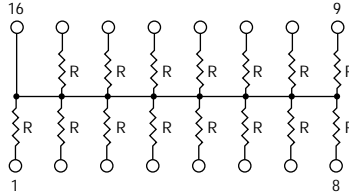

### Dual Terminator (3 Circuit)

- Model 4108R-3-R1/R2
- Model 4114R-3-R1/R2
- Model 4116R-3-R1/R2 (shown)
- Model 4118R-3-R1/R2
- Model 4120R-3-R1/R2

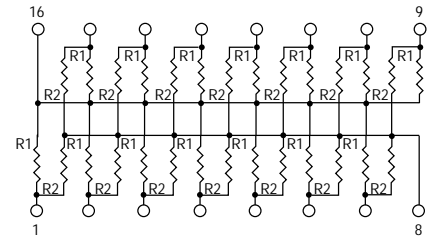

### Resistance Tolerance

- 10 ohms to 49 ohms .....±1 ohm
- 50 ohms to 5 megohms .....±2%\*
- Above 5 megohms .....±5%

### Power Rating per Resistor

At 70°C .....0.250 watt

### Power Temperature Derating Curve

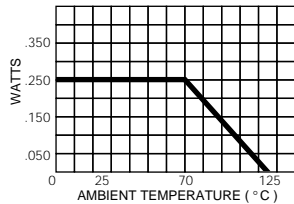

### Resistance Tolerance

- 10 ohms to 49 ohms .....±1 ohm
- 50 ohms to 5 megohms .....±2%\*
- Above 5 megohms .....±5%

### Power Rating per Resistor

At 70°C .....0.125 watt

### Power Temperature Derating Curve

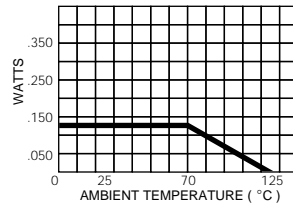

### Resistance Tolerance

- Below 100 ohms .....±2 ohms
- 100 ohms to 5 megohms .....±2%\*
- Above 5 megohms .....±5%

### Power Rating per Resistor

At 70°C .....0.125 watt

### Power Temperature Derating Curve

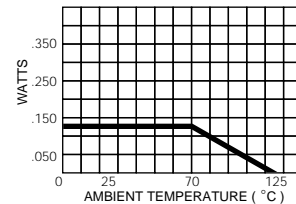

### Popular Resistance Values (1, 2 Circuits)\*\*

Ohms	Code	Ohms	Code	Ohms	Code	Ohms	Code	Ohms	Code
10	100	180	181	1,800	182	15,000	153	120,000	124
22	220	220	221	2,000	202	18,000	183	150,000	154
27	270	270	271	2,200	222	20,000	203	180,000	184
33	330	330	331	2,700	272	22,000	223	220,000	224
39	390	390	391	3,300	332	27,000	273	270,000	274
47	470	470	471	3,900	392	33,000	333	330,000	334
56	560	560	561	4,700	472	39,000	393	390,000	394
68	680	680	681	5,600	562	47,000	473	470,000	474
82	820	820	821	6,800	682	56,000	563	560,000	564
100	101	1,000	102	8,200	822	68,000	683	680,000	684
120	121	1,200	122	10,000	103	82,000	823	820,000	824
150	151	1,500	152	12,000	123	100,000	104	1,000,000	105

### Popular Resistance Values (3 Circuit)\*\*

Resistance			
(Ohms)		Code	
R <sub>1</sub>	R <sub>2</sub>	R <sub>1</sub>	R <sub>2</sub>
160	240	161	241
180	390	181	391
220	270	221	271
220	330	221	331
330	390	331	391
330	470	331	471
3,000	6,200	302	622

\* ±1% TOLERANCE IS AVAILABLE BY ADDING SUFFIX CODE "F" AFTER THE RESISTANCE CODE.

\*\*NON-STANDARD VALUES AVAILABLE, WITHIN RESISTANCE RANGE.

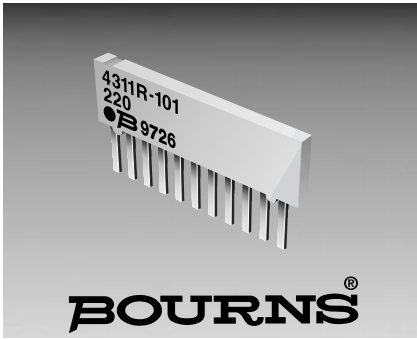

## Features

- Low profile provides compatibility with DIPs
- Compatible with automatic insertion equipment
- Superior package integrity
- Marking on contrasting background for permanent identification

- Top marking standard

# 4300R Series - Thick Film Molded SIPs

## Product Characteristics

Resistance Range .....10 ohms to 10 megohms  
 Maximum Operating Voltage.....100V  
 Temperature Coefficient of Resistance  
 50Ω to 2.2 MΩ.....±100ppm/°C  
 below 50Ω.....±250ppm/°C  
 above 2.2 MΩ.....±250ppm/°C  
 TCR Tracking .....50ppm/°C  
 maximum; equal values  
 Resistor Tolerance .....See circuits  
 Operating Temperature  
 .....-55°C to +125°C  
 Power Rating .....Derate to zero  
 power from + 70°C to + 125°C  
 Insulation Resistance  
 .....10,000 megohms minimum  
 Dielectric Withstanding Voltage  
 .....200 VRMS  
 Lead Solderability  
 .....Meet requirements of MIL-STD-202  
 Method 208

## Environmental Characteristics

TESTS PER MIL-STD-202.....ΔR MAX.  
 Short Time Overload.....±0.25%  
 Load Life.....±1.00%  
 Moisture Resistance.....±0.50%  
 Resistance to Soldering Heat  
 .....±0.25%  
 Terminal Strength.....±0.25%  
 Thermal Shock.....±0.25%

## Physical Characteristics

Flammability .....Conforms to UL94V-0  
 Lead Frame Material  
 .....Copper, solder coated  
 Body Material .....Novolac epoxy

## How To Order

43 06 R - 101 - 222

Model (43 = Molded SIP)  
 Number of Pins  
 Physical Configuration (R = Thick Film Low Profile)  
 Electrical Configuration  
 • 101 = Bussed  
 • 102 = Isolated  
 • 104 = Dual Terminator  
 Resistance Code  
 • First 2 digits are significant  
 • Third digit represents the number of zeros to follow.

Consult factory for other available options.

## Package Power Temp. Derating Curve

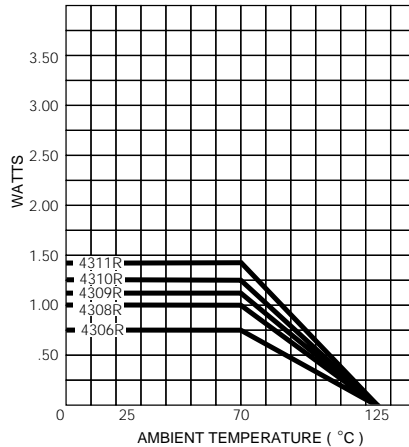

## Package Power Rating at 70°C

4306R.....0.75 watts  
 4308R.....1.00 watts  
 4309R.....1.13 watts  
 4310R.....1.25 watts  
 4311R.....1.38 watts

## Typical Part Marking

Represents total content. Layout may vary.

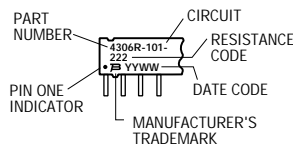

## Product Dimensions

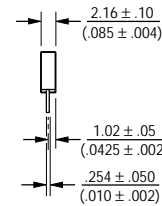
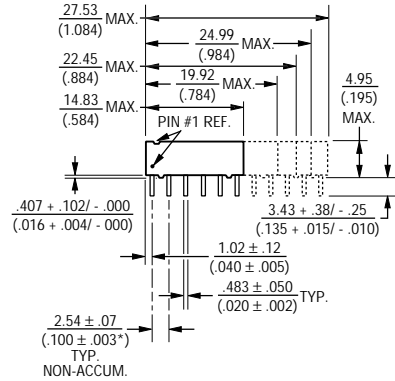

Governing dimensions are in metric. Dimensions in parentheses are inches and are approximate.

\*Terminal centerline to centerline measurements made at point of emergence of the lead from the body.

# 4300R Series - Thick Film Molded SIPs



## Isolated Resistors (102 Circuit)

Model 4306R-102-RC (6 Pin)  
 Model 4308R-102-RC (8 Pin)  
 Model 4310R-102-RC (10 Pin)

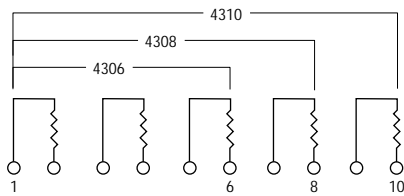

These models incorporate 3, 4 or 5 isolated thick-film resistors of equal value, each connected between two pins.

### Resistance Tolerance

10 ohms to 49 ohms .....±1 ohm  
 50 ohms to 5 megohms.....±2%\*  
 Above 5 megohms.....±5%

### Power Rating per Resistor

At 70°C .....0.30 watt

### Power Temperature Derating Curve

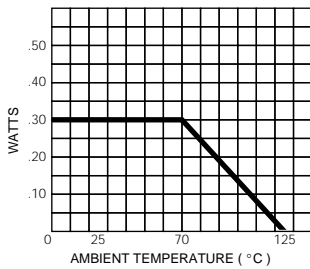

## Bussed Resistors (101 Circuit)

Model 4306R-101-RC (6 Pin)  
 Model 4308R-101-RC (8 Pin)  
 Model 4309R-101-RC (9 Pin)  
 Model 4310R-101-RC (10 Pin)  
 Model 4311R-101-RC (11 Pin)

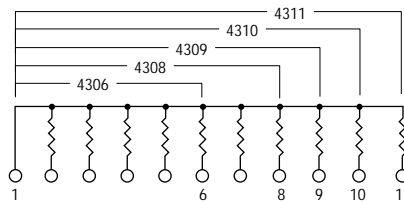

These models incorporate 5, 7, 8, 9 or 10 thick-film resistors of equal value, each connected between a separate pin.

### Resistance Tolerance

10 ohms to 49 ohms .....±1 ohm  
 50 ohms to 5 megohms.....±2%\*  
 Above 5 megohms.....±5%

### Power Rating per Resistor

At 70°C .....0.20 watt

### Power Temperature Derating Curve

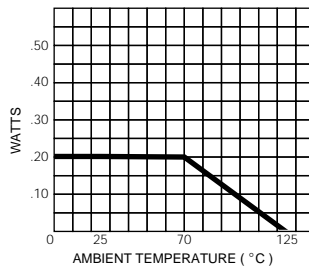

## Dual Terminator (104 Circuit)

Model 4306R-104-R1/R2  
 Model 4308R-104-R1/R2 (shown)  
 Model 4309R-104-R1/R2  
 Model 4310R-104-R1/R2  
 Model 4311R-104-R1/R2

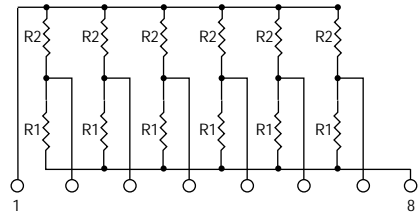

4308R-104 (shown above) is an 8-pin configuration and terminates 6 lines. Pins 1 and 8 are common for ground and power, respectively. Twelve thick-film resistors are paired in series between the common lines (pins 1 and 8).

### Resistance Tolerance

Below 100 ohms.....±2 ohms  
 100 ohms to 5 megohms.....±2%\*  
 Above 5 megohms.....±5%

### Power Rating per Resistor

At 70°C .....0.20 watt

### Power Temperature Derating Curve

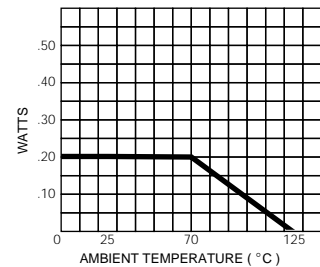

## Popular Resistance Values (101, 102 Circuits)\*\*

Ohms	Code	Ohms	Code	Ohms	Code	Ohms	Code	Ohms	Code
10	100	180	181	1,800	182	15,000	153	120,000	124
22	220	220	221	2,000	202	18,000	183	150,000	154
27	270	270	271	2,200	222	20,000	203	180,000	184
33	330	330	331	2,700	272	22,000	223	220,000	224
39	390	390	391	3,300	332	27,000	273	270,000	274
47	470	470	471	3,900	392	33,000	333	330,000	334
56	560	560	561	4,700	472	39,000	393	390,000	394
68	680	680	681	5,600	562	47,000	473	470,000	474
82	820	820	821	6,800	682	56,000	563	560,000	564
100	101	1,000	102	8,200	822	68,000	683	680,000	684
120	121	1,200	122	10,000	103	82,000	823	820,000	824
150	151	1,500	152	12,000	123	100,000	104	1,000,000	105

## Popular Resistance Values (104 Circuit)\*\*

Resistance			
(Ohms)		Code	
R <sub>1</sub>	R <sub>2</sub>	R <sub>1</sub>	R <sub>2</sub>
160	240	161	241
180	390	181	391
220	270	221	271
220	330	221	331
330	390	331	391
330	470	331	471
3,000	6,200	302	622

\* ±1% TOLERANCE IS AVAILABLE BY ADDING SUFFIX CODE "F" AFTER THE RESISTANCE CODE.

\*\*NON-STANDARD VALUES AVAILABLE, WITHIN RESISTANCE RANGE.

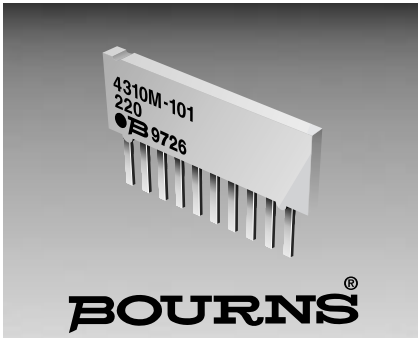

## Features

- Medium profile offers increased power handling
- Compatible with automatic insertion equipment
- Superior package integrity
- Marking on contrasting background for permanent identification

- Top marking standard

# 4300M Series - Thick Film Molded SIPs

## Product Characteristics

Resistance Range .....10 ohms to 10 megohms  
 Maximum Operating Voltage.....100V  
 Temperature Coefficient of Resistance  
 50Ω to 2.2 MΩ.....±100ppm/°C  
 below 50Ω.....±250ppm/°C  
 above 2.2 MΩ.....±250ppm/°C  
 TCR Tracking .....50ppm/°C  
 maximum; equal values  
 Resistor Tolerance .....See circuits  
 Operating Temperature .....-55°C to +125°C  
 Insulation Resistance .....10,000 megohms minimum  
 Dielectric Withstanding Voltage .....200 VRMS  
 Lead Solderability .....Meet requirements of MIL-STD-202  
 Method 208

## Environmental Characteristics

TESTS PER MIL-STD-202.....ΔR MAX.  
 Short Time Overload.....±0.25%  
 Load Life .....±1.00%  
 Moisture Resistance .....±0.50%  
 Resistance to Soldering Heat .....±0.25%  
 Terminal Strength.....±0.25%  
 Thermal Shock.....±0.25%

## Physical Characteristics

Flammability .....Conforms to UL94V-0  
 Lead Frame Material .....Copper, solder coated  
 Body Material .....Novolac epoxy

## How To Order

**43 06 M - 101 - 222**

Model \_\_\_\_\_  
 (43 = Molded SIP)  
 Number of Pins \_\_\_\_\_  
 Physical Configuration \_\_\_\_\_  
 (M = Thick Film Medium Profile)  
 Electrical Configuration \_\_\_\_\_  
 • 101 = Bussed  
 • 102 = Isolated  
 • 104 = Dual Terminator  
 Resistance Code \_\_\_\_\_

- First 2 digits are significant
- Third digit represents the number of zeros to follow.

Consult factory for other available options.

## Package Power Temp. Derating Curve

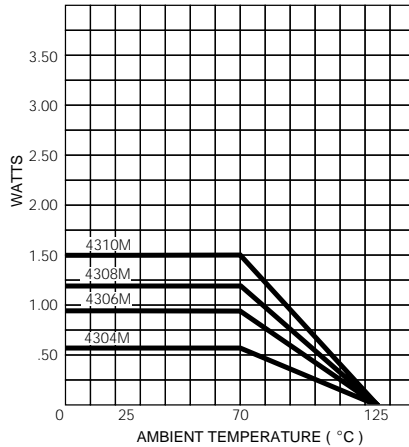

## Package Power Rating at 70°C

4304M .....0.60 watts  
 4306M .....0.90 watts  
 4308M .....1.20 watts  
 4310M .....1.50 watts

## Typical Part Marking

Represents total content. Layout may vary.

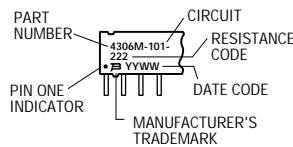

## Product Dimensions

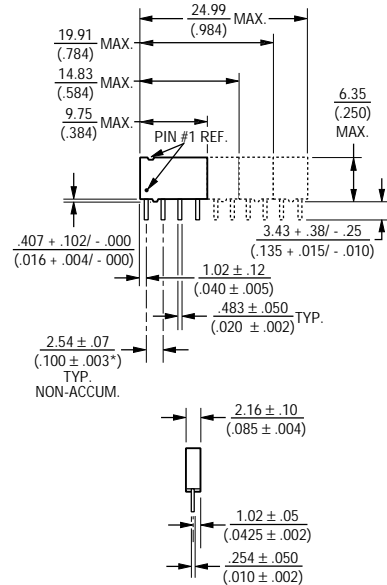

Governing dimensions are in metric. Dimensions in parentheses are inches and are approximate.

\*Terminal centerline to centerline measurements made at point of emergence of the lead from the body.

# 4300M Series - Thick Film Molded SIPs



### Isolated Resistors (102 Circuit)

- Model 4304M-102-RC (4 Pin)
- Model 4306M-102-RC (6 Pin)
- Model 4308M-102-RC (8 Pin)
- Model 4310M-102-RC (10 Pin)

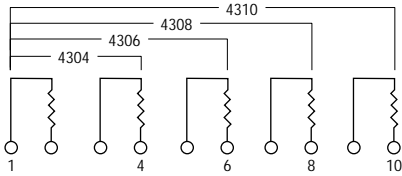

These models incorporate 2, 3, 4, or 5 isolated thick-film resistors of equal value, each connected between two pins.

### Resistance Tolerance

- 10 ohms to 49 ohms .....±1 ohm
- 50 ohms to 5 megohms.....±2%\*
- Above 5 megohms.....±5%

### Power Rating per Resistor

At 70°C .....0.40 watt

### Power Temperature Derating Curve

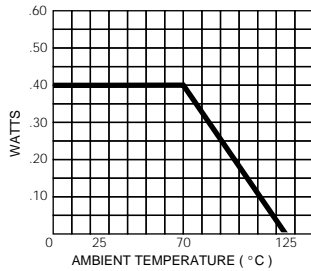

### Bussed Resistors (101 Circuit)

- Model 4304M-101-RC (4 Pin)
- Model 4306M-101-RC (6 Pin)
- Model 4308M-101-RC (8 Pin)
- Model 4310M-101-RC (10 Pin)

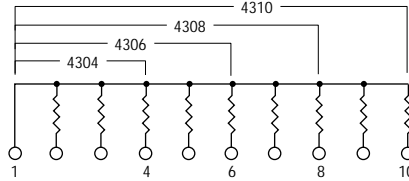

These models incorporate 3, 5, 7, or 9 thick-film resistors of equal value, each connected between a common bus (pin 1) and a separate pin.

### Resistance Tolerance

- 10 ohms to 49 ohms .....±1 ohm
- 50 ohms to 5 megohms.....±2%\*
- Above 5 megohms.....±5%

### Power Rating per Resistor

At 70°C .....0.25 watt

### Power Temperature Derating Curve

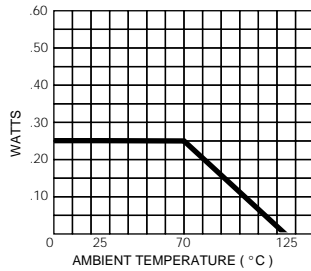

### Dual Terminator (104 Circuit)

- Model 4304M-104-R1/R2
- Model 4306M-104-R1/R2
- Model 4308M-104-R1/R2 (shown)
- Model 4310M-104-R1/R2

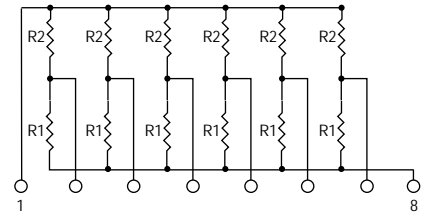

4308M-104 (shown above) is an 8-pin configuration and terminates 6 lines. Pins 1 and 8 are common for ground and power, respectively. Twelve thick-film resistors are paired in series between the common lines (pins 1 and 8).

### Resistance Tolerance

- Below 100 ohms .....±2 ohms
- 100 ohms to 5 megohms.....±2%\*
- Above 5 megohms.....±5%

### Power Rating per Resistor

At 70°C .....0.25 watt

### Power Temperature Derating Curve

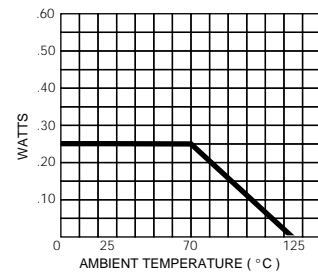

### Popular Resistance Values (101, 102 Circuits)\*\*

Ohms	Code	Ohms	Code	Ohms	Code	Ohms	Code	Ohms	Code
10	100	180	181	1,800	182	15,000	153	120,000	124
22	220	220	221	2,000	202	18,000	183	150,000	154
27	270	270	271	2,200	222	20,000	203	180,000	184
33	330	330	331	2,700	272	22,000	223	220,000	224
39	390	390	391	3,300	332	27,000	273	270,000	274
47	470	470	471	3,900	392	33,000	333	330,000	334
56	560	560	561	4,700	472	39,000	393	390,000	394
68	680	680	681	5,600	562	47,000	473	470,000	474
82	820	820	821	6,800	682	56,000	563	560,000	564
100	101	1,000	102	8,200	822	68,000	683	680,000	684
120	121	1,200	122	10,000	103	82,000	823	820,000	824
150	151	1,500	152	12,000	123	100,000	104	1,000,000	105

### Popular Resistance Values (104 Circuit)\*\*

Resistance			
(Ohms)		Code	
R <sub>1</sub>	R <sub>2</sub>	R <sub>1</sub>	R <sub>2</sub>
160	240	161	241
180	390	181	391
220	270	221	271
220	330	221	331
330	390	331	391
330	470	331	471
3,000	6,200	302	622

\* ±1% TOLERANCE IS AVAILABLE BY ADDING SUFFIX CODE "F" AFTER THE RESISTANCE CODE.

\*\*NON-STANDARD VALUES AVAILABLE, WITHIN RESISTANCE RANGE.

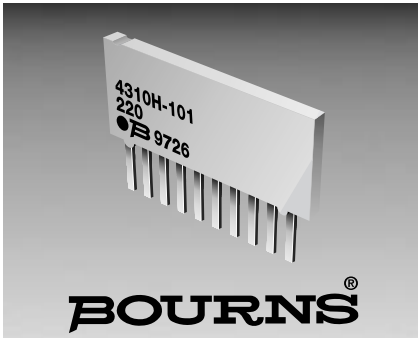

## Features

- High profile offers increased power handling
- Compatible with automatic insertion equipment
- Superior package integrity
- Marking on contrasting background for permanent identification

- Top marking standard

# 4300H Series - Thick Film Molded SIPs

## Product Characteristics

Resistance Range .....10 ohms to 10 megohms  
 Maximum Operating Voltage.....100V  
 Temperature Coefficient of Resistance  
 50Ω to 2.2 MΩ.....±100ppm/°C  
 below 50Ω.....±250ppm/°C  
 above 2.2 MΩ.....±250ppm/°C  
 TCR Tracking .....50ppm/°C  
 maximum; equal values  
 Resistor Tolerance .....See circuits  
 Operating Temperature  
 .....-55°C to +125°C  
 Insulation Resistance  
 .....10,000 megohms minimum  
 Dielectric Withstanding Voltage  
 .....200 VRMS  
 Lead Solderability  
 .....Meet requirements of MIL-STD-202  
 Method 208

## Environmental Characteristics

TESTS PER MIL-STD-202.....ΔR MAX.  
 Short Time Overload.....±0.25%  
 Load Life .....±1.00%  
 Moisture Resistance .....±0.50%  
 Resistance to Soldering Heat  
 .....±0.25%  
 Terminal Strength.....±0.25%  
 Thermal Shock.....±0.25%

## Physical Characteristics

Flammability .....Conforms to UL94V-0  
 Lead Frame Material  
 .....Copper, solder coated  
 Body Material .....Novolac epoxy

## How To Order

**43 06 H - 101 - 222**

Model \_\_\_\_\_  
 (43 = Molded SIP)  
 Number of Pins \_\_\_\_\_  
 Physical Configuration \_\_\_\_\_  
 (H = Thick Film High Profile)  
 Electrical Configuration \_\_\_\_\_  
 • 101 = Bussed  
 • 102 = Isolated  
 • 104 = Dual Terminator  
 Resistance Code \_\_\_\_\_  
 • First 2 digits are significant  
 • Third digit represents the  
 number of zeros to follow.

Consult factory for other available options.

## Package Power Temp. Derating Curve

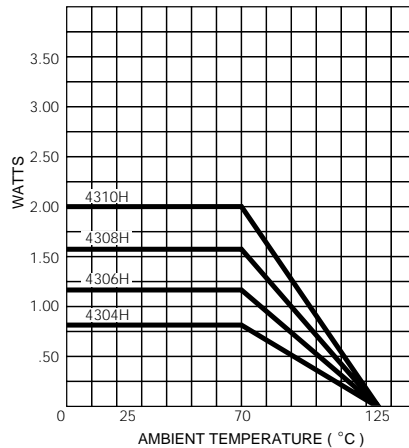

## Package Power Rating at 70°C

4304H .....0.80 watts  
 4306H .....1.20 watts  
 4308H .....1.60 watts  
 4310H .....2.00 watts

## Typical Part Marking

Represents total content. Layout may vary.

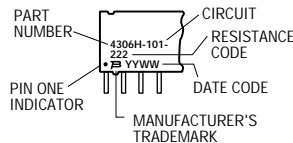

## Product Dimensions

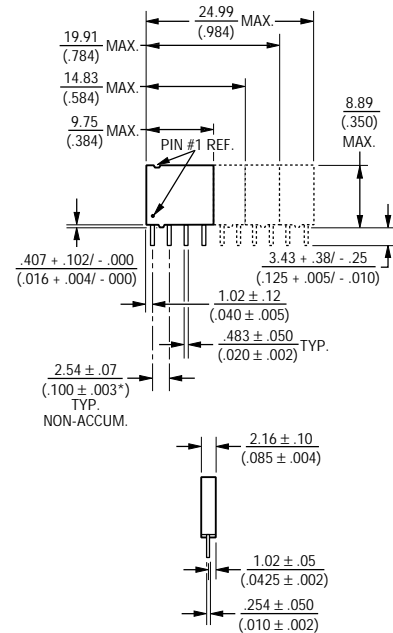

Governing dimensions are in metric. Dimensions in parentheses are inches and are approximate.

\*Terminal centerline to centerline measurements made at point of emergence of the lead from the body.



# 4300H Series - Thick Film Molded SIPs



### Isolated Resistors (102 Circuit)

- Model 4304H-102-RC (4 Pin)
- Model 4306H-102-RC (6 Pin)
- Model 4308H-102-RC (8 Pin)
- Model 4310H-102-RC (10 Pin)

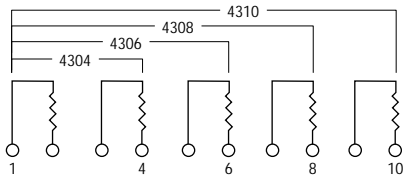

These models incorporate 2, 3, 4, or 5 isolated thick-film resistors of equal value, each connected between two pins.

### Resistance Tolerance

- 10 ohms to 49 ohms .....±1 ohm
- 50 ohms to 5 megohms.....±2%\*
- Above 5 megohms.....±5%

### Power Rating Per Resistor

At 70°C .....0.50 watt

### Power Temperature Derating Curve

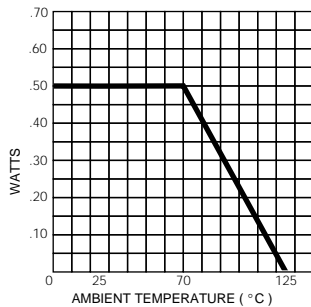

### Bussed Resistors (101 Circuit)

- Model 4304H-101-RC (4 Pin)
- Model 4306H-101-RC (6 Pin)
- Model 4308H-101-RC (8 Pin)
- Model 4310H-101-RC (10 Pin)

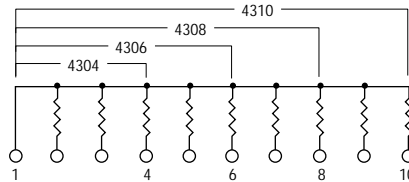

These models incorporate 3, 5, 7, or 9 thick-film resistors of equal value, each connected between a common bus (pin 1) and a separate pin.

### Resistance Tolerance

- 10 ohms to 49 ohms .....±1 ohm
- 50 ohms to 5 megohms.....±2%\*
- Above 5 megohms.....±5%

### Power Rating Per Resistor

At 70°C .....0.30 watt

### Power Temperature Derating Curve

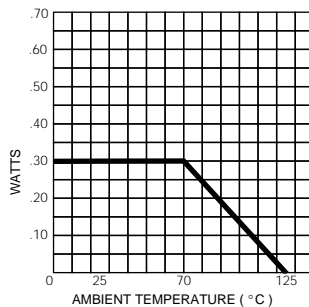

### Dual Terminator (104 Circuit)

- Model 4304H-104-R1/R2
- Model 4306H-104-R1/R2
- Model 4308H-104-R1/R2 (shown)
- Model 4310H-104-R1/R2

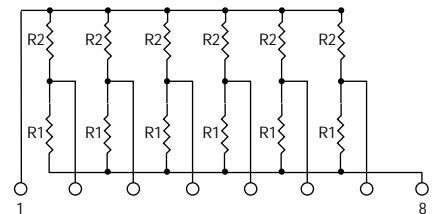

4308H-104 (shown above) is an 8-pin configuration and terminates 6 lines. Pins 1 and 8 are common for ground and power, respectively. Twelve thick-film resistors are paired in series between the common lines (pins 1 and 8).

### Resistance Tolerance

- Below 100 ohms .....±2 ohms
- 100 ohms to 5 megohms.....±2%\*
- Above 5 megohms.....±5%

### Power Rating Per Resistor

At 70°C .....0.30 watt

### Power Temperature Derating Curve

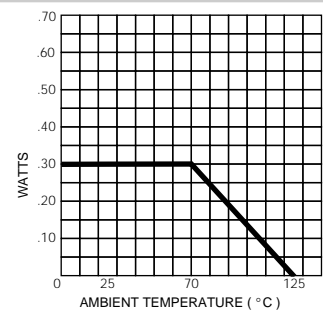

### Popular Resistance Values (101, 102 Circuits)\*\*

Ohms	Code	Ohms	Code	Ohms	Code	Ohms	Code	Ohms	Code
10	100	180	181	1,800	182	15,000	153	120,000	124
22	220	220	221	2,000	202	18,000	183	150,000	154
27	270	270	271	2,200	222	20,000	203	180,000	184
33	330	330	331	2,700	272	22,000	223	220,000	224
39	390	390	391	3,300	332	27,000	273	270,000	274
47	470	470	471	3,900	392	33,000	333	330,000	334
56	560	560	561	4,700	472	39,000	393	390,000	394
68	680	680	681	5,600	562	47,000	473	470,000	474
82	820	820	821	6,800	682	56,000	563	560,000	564
100	101	1,000	102	8,200	822	68,000	683	680,000	684
120	121	1,200	122	10,000	103	82,000	823	820,000	824
150	151	1,500	152	12,000	123	100,000	104	1,000,000	105

\* ±1% TOLERANCE IS AVAILABLE BY ADDING SUFFIX CODE "F" AFTER THE RESISTANCE CODE.

\*\*NON-STANDARD VALUES AVAILABLE, WITHIN RESISTANCE RANGE.

### Popular Resistance Values (104 Circuit)\*\*

Resistance			
(Ohms)		Code	
R <sub>1</sub>	R <sub>2</sub>	R <sub>1</sub>	R <sub>2</sub>
160	240	161	241
180	390	181	391
220	270	221	271
220	330	221	331
330	390	331	391
330	470	331	471
3,000	6,200	302	622



## Features

- Low profile is compatible with DIPs
- Wide assortment of pin packages enhances design flexibility
- Ammo-pak packaging available
- Recommended for rosin flux and solvent clean or no clean flux processes

- Marking on contrasting background for permanent identification

# 4600X Series - Thick Film Conformal SIPs

## Product Characteristics

Resistance Range ..... 10 ohms to 10 megohms  
 Maximum Operating Voltage ..... 100V  
 Temperature Coefficient of Resistance  
 50Ω to 2.2 MΩ ..... ±100ppm/°C  
 below 50Ω ..... ±250ppm/°C  
 above 2.2 MΩ ..... ±250ppm/°C  
 TCR Tracking ..... 50ppm/°C  
 maximum; equal values  
 Resistor Tolerance ..... See circuits  
 Insulation Resistance  
 ..... 10,000 megohms minimum  
 Dielectric Withstanding Voltage  
 ..... 200 VRMS  
 Operating Temperature  
 ..... -55°C to +125°C

## Environmental Characteristics

TESTS PER MIL-STD-202 ..... ΔR MAX.  
 Short Time Overload ..... ±0.25%  
 Load Life ..... ±1.00%  
 Moisture Resistance ..... ±0.50%  
 Resistance to Soldering Heat ..... ±0.25%  
 Terminal Strength ..... ±0.25%  
 Thermal Shock ..... ±0.25%

## Physical Characteristics

Flammability ..... Conforms to UL94V-0  
 Body Material ..... Epoxy resin  
 Standard Packaging  
 ..... Bulk, Ammo-pak available

## Package Power Temp. Derating Curve

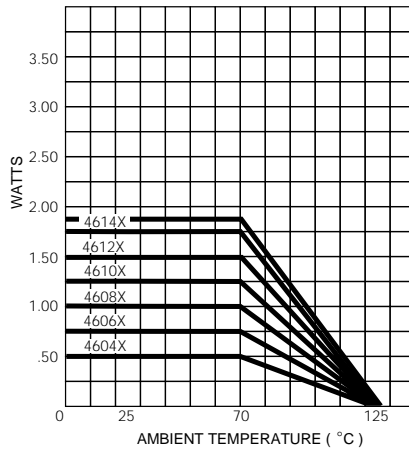

## Package Power Ratings (Watts)

Pkg.	Ambient Temperature		Pkg.	Ambient Temperature	
	70°C			70°C	
4604X	0.50		4610X	1.25	
4605X	0.63		4611X	1.38	
4606X	0.75		4612X	1.50	
4607X	0.88		4613X	1.63	
4608X	1.00		4614X	1.75	
4609X	1.13				

## Typical Part Marking

Represents total content. Layout may vary.

Part Number	Part Number
4606X-101-RC	6X-1-RC
4608X-102-RC	8X-2-RC
4610X-104-RC/RC	10X-4-RC/RC

RC = ohmic value, 3-digit resistance code.

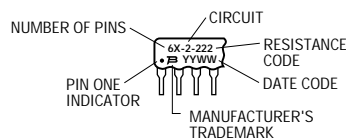

## Product Dimensions

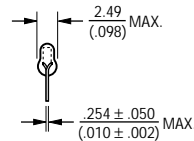
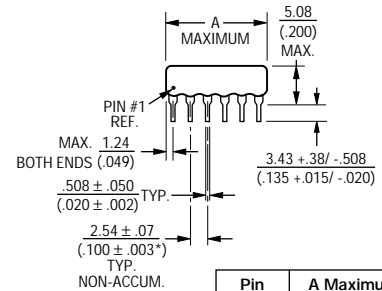

Pin Count	A Maximum mm (Inches)
4	10.11 (.398)
5	12.65 (.498)
6	15.19 (.598)
7	17.73 (.698)
8	20.27 (.798)
9	22.81 (.898)
10	25.35 (.998)
11	27.89 (1.098)
12	30.43 (1.198)
13	32.97 (1.298)
14	35.51 (1.398)

Maximum package length is equal to 2.54mm (.100") times the number of pins, less .005mm (.002").

Governing dimensions are in metric. Dimensions in parentheses are inches and are approximate.

\*Terminal centerline to centerline measurements made at point of emergence of the lead from the body.

## How To Order

46 06 X - 101 - 222

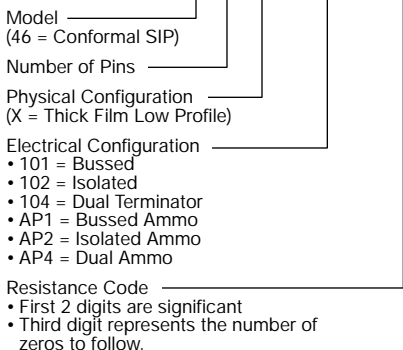

Consult factory for other available options.

# 4600X Series - Thick Film Conformal SIPs



## Isolated Resistors (102 Circuit)

Model 4600X-102-RC  
4, 6, 8, 10, 12, 14 Pin

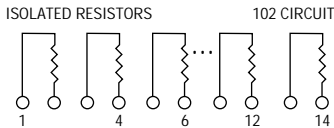

These models incorporate 2 to 7 isolated thick-film resistors of equal value, each connected between two pins.

### Resistance Tolerance

10 ohms to 49 ohms .....±1 ohm  
50 ohms to 5 megohms.....±2%\*  
Above 5 megohms.....±5%

### Power Rating per Resistor

At 70°C .....0.30 watt

### Power Temperature Derating Curve

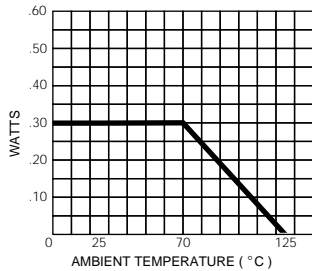

## Bussed Resistors (101 Circuit)

Model 4600X-101-RC  
4 through 14 Pin

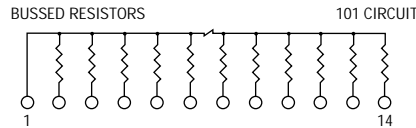

These models incorporate 3 to 13 thick-film resistors of equal value, each connected between a common bus (pin 1) and a separate pin.

### Resistance Tolerance

10 ohms to 49 ohms .....±1 ohm  
50 ohms to 5 megohms.....±2%\*  
Above 5 megohms.....±5%

### Power Rating per Resistor

At 70°C .....0.20 watt

### Power Temperature Derating Curve

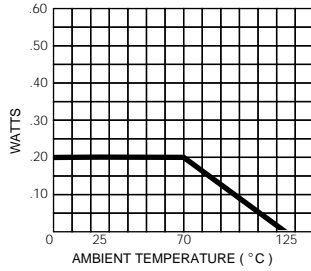

## Dual Terminator (104 Circuit)

Model 4600X-104-R1/R2  
4 through 14 Pin

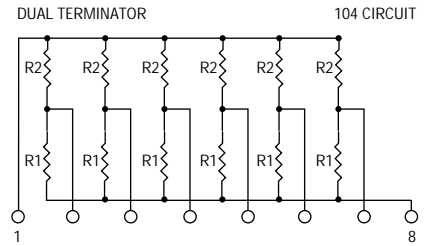

The 4608X-104 (shown above) is an 8-pin configuration and terminates 6 lines. Pins 1 and 8 are common for ground and power, respectively. Twelve thick-film resistors are paired in series between the common lines (pins 1 and 8).

### Resistance Tolerance

Below 100 ohms.....±2 ohms  
100 ohms to 5 megohms.....±2%\*  
Above 5 megohms.....±5%

### Power Rating per Resistor

At 70°C .....0.20 watt

### Power Temperature Derating Curve

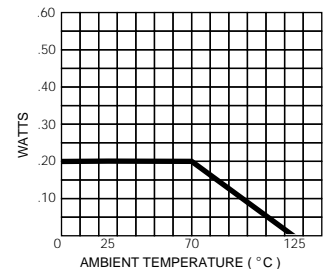

## Popular Resistance Values (101, 102 Circuits)\*\*

Ohms	Code	Ohms	Code	Ohms	Code	Ohms	Code	Ohms	Code
10	100	180	181	1,800	182	15,000	153	120,000	124
22	220	220	221	2,000	202	18,000	183	150,000	154
27	270	270	271	2,200	222	20,000	203	180,000	184
33	330	330	331	2,700	272	22,000	223	220,000	224
39	390	390	391	3,300	332	27,000	273	270,000	274
47	470	470	471	3,900	392	33,000	333	330,000	334
56	560	560	561	4,700	472	39,000	393	390,000	394
68	680	680	681	5,600	562	47,000	473	470,000	474
82	820	820	821	6,800	682	56,000	563	560,000	564
100	101	1,000	102	8,200	822	68,000	683	680,000	684
120	121	1,200	122	10,000	103	82,000	823	820,000	824
150	151	1,500	152	12,000	123	100,000	104	1,000,000	105

\* ±1% TOLERANCE IS AVAILABLE BY ADDING SUFFIX CODE "F" AFTER THE RESISTANCE CODE.

\*\*NON-STANDARD VALUES AVAILABLE, WITHIN RESISTANCE RANGE.

## Popular Resistance Values (104 Circuit)\*\*

Resistance			
(Ohms)		Code	
R <sub>1</sub>	R <sub>2</sub>	R <sub>1</sub>	R <sub>2</sub>
160	240	161	241
180	390	181	391
220	270	221	271
220	330	221	331
330	390	331	391
330	470	331	471
3,000	6,200	302	622

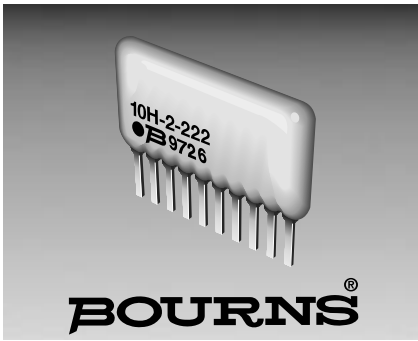

## Features

- High profile offers increased power handling
- Wide assortment of pin packages enhances design flexibility
- Ammo-pak packaging available
- Recommended for rosin flux and solvent clean or no clean flux processes

- Marking on contrasting background for permanent identification

# 4600H Series - Thick Film Conformal SIPs

## Product Characteristics

Resistance Range ..... 10 ohms to 10 megohms  
 Maximum Operating Voltage ..... 100V  
 Temperature Coefficient of Resistance  
 50Ω to 2.2 MΩ ..... ±100ppm/°C  
 below 50Ω ..... ±250ppm/°C  
 above 2.2 MΩ ..... ±250ppm/°C  
 TCR Tracking ..... 50ppm/°C  
 maximum; equal values  
 Resistor Tolerance ..... See circuits  
 Insulation Resistance  
 ..... 10,000 megohms minimum  
 Dielectric Withstanding Voltage  
 ..... 200 VRMS  
 Operating Temperature  
 ..... -55°C to +125°C

## Environmental Characteristics

TESTS PER MIL-STD-202 ..... ΔR MAX.  
 Short Time Overload ..... ±0.25%  
 Load Life ..... ±1.00%  
 Moisture Resistance ..... ±0.50%  
 Resistance to Soldering Heat ..... ±0.25%  
 Terminal Strength ..... ±0.25%  
 Thermal Shock ..... ±0.25%

## Physical Characteristics

Flammability ..... Conforms to UL94V-0  
 Body Material ..... Epoxy resin  
 Standard Packaging  
 ..... Bulk, Ammo-pak available

## How To Order

46 06 H - 101 - 222

Model \_\_\_\_\_  
 (46 = Conformal SIP)  
 Number of Pins \_\_\_\_\_  
 Physical Configuration  
 (H = Thick Film High Profile)  
 Electrical Configuration  
 • 101 = Bussed  
 • 102 = Isolated  
 • 104 = Dual Terminator  
 • AP1 = Bussed Ammo  
 • AP2 = Isolated Ammo  
 • AP4 = Dual Ammo

Resistance Code \_\_\_\_\_  
 • First 2 digits are significant  
 • Third digit represents the number of zeros to follow.

Consult factory for other available options.

## Package Power Temp. Derating Curve

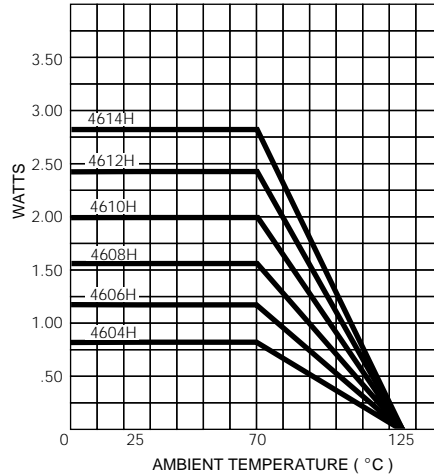

## Product Dimensions

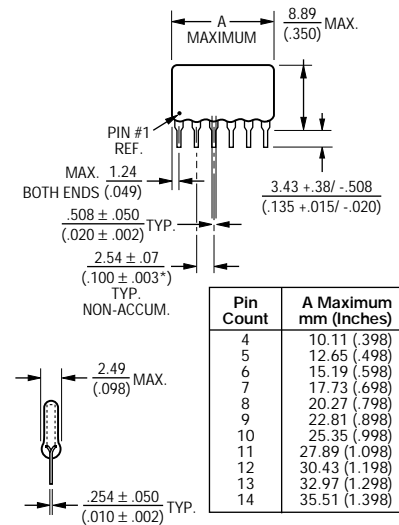

Maximum package length is equal to 2.54mm (.100") times the number of pins, less .005mm (.002").

Governing dimensions are in metric. Dimensions in parentheses are inches and are approximate.

\* Terminal centerline to centerline measurements made at point of emergence of the lead from the body.

## Package Power Ratings (Watts)

Pkg.	Ambient Temperature	Pkg.	Ambient Temperature
	70°C		70°C
4604H	0.80	4610H	2.00
4605H	1.00	4611H	2.20
4606H	1.20	4612H	2.40
4607H	1.40	4613H	2.60
4608H	1.60	4614H	2.80
4609H	1.80		

## Typical Part Marking

Represents total content. Layout may vary.

Part Number	Part Number
4606H-101-RC	6H-1-RC
4608H-102-RC	8H-2-RC
4610H-104-RC/RC	10H-4-RC/RC

RC = ohmic value, 3-digit resistance code.

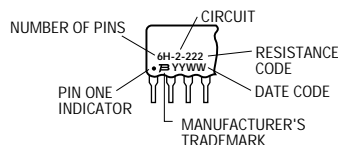

# 4600H Series - Thick Film Conformal SIPs



## Isolated Resistors (102 Circuit)

Model 4600H-102  
4, 6, 8, 10, 12 or 14 Pin

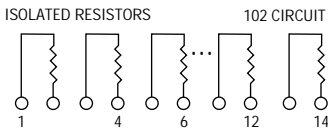

These models incorporate 2 to 7 isolated thick-film resistors of equal value, each connected between two pins.

### Resistance Tolerance

10 ohms to 49 ohms .....±1 ohm  
50 ohms to 5 megohms .....±2%\*  
Above 5 megohms .....±5%

### Power Rating per Resistor

At 70°C .....0.50 watt

### Power Temperature Derating Curve

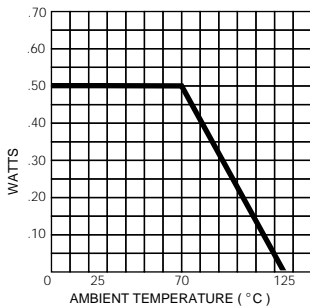

## Bussed Resistors (101 Circuit)

Model 4600H-101-RC  
4 through 14 Pin

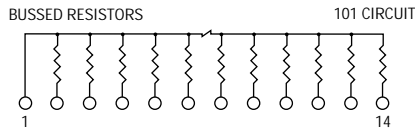

These models incorporate 3 to 13 thick-film resistors of equal value, each connected between a common bus (pin 1) and a separate pin.

### Resistance Tolerance

10 ohms to 49 ohms .....±1 ohm  
50 ohms to 5 megohms .....±2%\*  
Above 5 megohms .....±5%

### Power Rating per Resistor

At 70°C .....0.30 watt

### Power Temperature Derating Curve

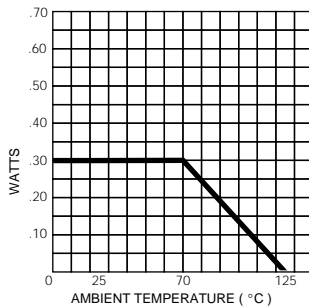

## Dual Terminator (104 Circuit)

Model 4600H-104-R1/R2  
4 through 14 Pin

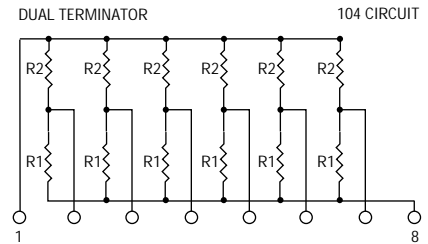

The 4608H-104 (shown above) is an 8-pin configuration and terminates 6 lines. Pins 1 and 8 are common for ground and power, respectively. Twelve thick-film resistors are paired in series between the common lines (pins 1 and 8).

### Resistance Tolerance

Below 100 ohms .....±2 ohms  
100 ohms to 5 megohms .....±2%\*  
Above 5 megohms .....±5%

### Power Rating per Resistor

At 70°C .....0.30 watt

### Power Temperature Derating Curve

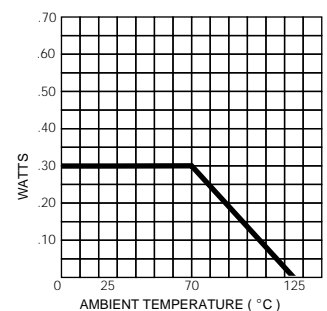

## Popular Resistance Values (101, 102 Circuits)\*\*

Ohms	Code	Ohms	Code	Ohms	Code	Ohms	Code	Ohms	Code
10	100	180	181	1,800	182	15,000	153	120,000	124
22	220	220	221	2,000	202	18,000	183	150,000	154
27	270	270	271	2,200	222	20,000	203	180,000	184
33	330	330	331	2,700	272	22,000	223	220,000	224
39	390	390	391	3,300	332	27,000	273	270,000	274
47	470	470	471	3,900	392	33,000	333	330,000	334
56	560	560	561	4,700	472	39,000	393	390,000	394
68	680	680	681	5,600	562	47,000	473	470,000	474
82	820	820	821	6,800	682	56,000	563	560,000	564
100	101	1,000	102	8,200	822	68,000	683	680,000	684
120	121	1,200	122	10,000	103	82,000	823	820,000	824
150	151	1,500	152	12,000	123	100,000	104	1,000,000	105

## Popular Resistance Values (104 Circuit)\*\*

Resistance			
(Ohms)		Code	
R <sub>1</sub>	R <sub>2</sub>	R <sub>1</sub>	R <sub>2</sub>
160	240	161	241
180	390	181	391
220	270	221	271
220	330	221	331
330	390	331	391
330	470	331	471
3,000	6,200	302	622

\* ±1% TOLERANCE IS AVAILABLE BY ADDING SUFFIX CODE "F" AFTER THE RESISTANCE CODE.

\*\*NON-STANDARD VALUES AVAILABLE, WITHIN RESISTANCE RANGE.



## Features

- Medium profile offers increased power handling
- Wide assortment of pin packages enhances design flexibility
- Ammo-pak packaging available

- Recommended for rosin flux and solvent clean or no clean flux processes
- Marking on contrasting background for permanent identification

# 4600M Series - Thick Film Conformal SIPs

## Electrical Characteristics

Standard Resistance Values .....10 ohms to 10 megohms  
 Maximum Operating Voltage.....100V  
 Temperature Coefficient of Resistance  
 50W to 2.2 MW .....±100ppm/°C  
 below 50W .....±250ppm/°C  
 above 2.2 MW .....±250ppm/°C  
 TCR Tracking .....50ppm/°C maximum; equal values  
 Resistor Tolerance .....See circuits  
 Insulation Resistance .....10,000 megohms minimum  
 Dielectric Withstanding Voltage .....200 VRMS  
 Operating Temperature .....-55°C to +125°C

## Environmental Characteristics

TESTS PER MIL-STD-202.....ΔR MAX.  
 Short Time Overload.....±0.25%  
 Load Life .....±1.00%  
 Moisture Resistance .....±0.50%  
 Resistance to Soldering Heat .....±0.25%  
 Terminal Strength.....±0.25%  
 Thermal Shock.....±0.25%

## Physical Characteristics

Flammability .....Conforms to UL94V-0  
 Body Material.....Epoxy resin  
 Standard Packaging .....Bulk, Ammo-pak available

## How To Order

**46 06 M - 101 - 222**

Model (46 = Conformal SIP)  
 Number of Pins  
 Physical Configuration (M = Thick Film Medium Profile)  
 Electrical Configuration  
 • 101 = Bussed  
 • 102 = Isolated  
 • 104 = Dual Terminator  
 • AP1 = Bussed Ammo  
 • AP2 = Isolated Ammo  
 • AP4 = Dual Ammo  
 Resistance Code  
 • First 2 digits are significant  
 • Third digit represents the number of zeros to follow.

Consult factory for other available options.

## Package Power Temp. Derating Curve

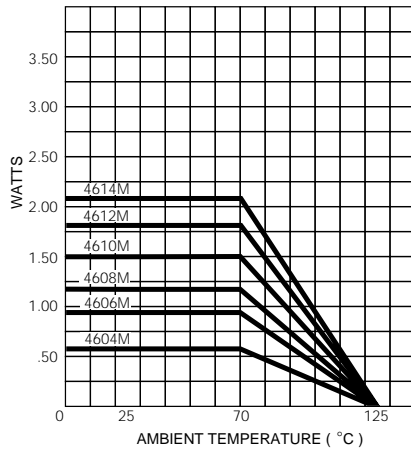

## Package Power Ratings (Watts)

Pkg.	Ambient Temperature 70°C	Pkg.	Ambient Temperature 70°C
4604M	0.60	4610M	1.50
4605M	0.75	4611M	1.65
4606M	0.90	4612M	1.80
4607M	1.05	4613M	1.95
4608M	1.20	4614M	2.10
4609M	1.35		

## Typical Part Marking

Represents total content. Layout may vary.

Part Number	Part Number
4606M-101-RC	6M-1-RC
4608M-102-RC	8M-2-RC
4610M-104-RC/RC	10M-4-RC/RC

RC = ohmic value, 3-digit resistance code.

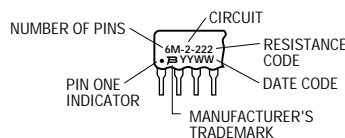

## Product Dimensions

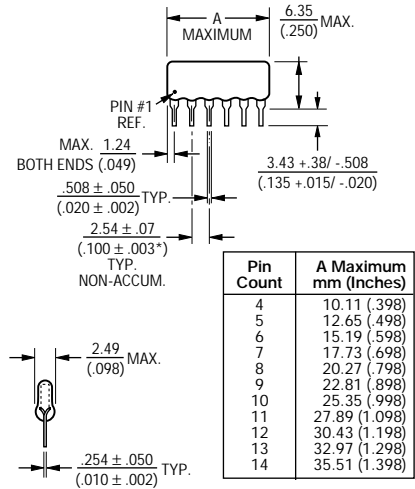

Maximum package length is equal to 2.54mm (.100") times the number of pins, less .005mm (.002").

Governing dimensions are in metric. Dimensions in parentheses are inches and are approximate.

\*Terminal centerline to centerline measurements made at point of emergence of the lead from the body.

# 4600M Series - Thick Film Conformal SIPs



## Isolated Resistors (102 Circuit)

Model 4600M-102-RC  
4, 6, 8, 10, 12, 14 Pin

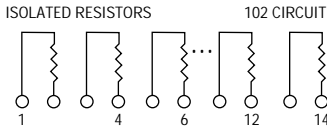

These models incorporate 2 to 7 isolated thick-film resistors of equal value, each connected between two pins.

### Resistance Tolerance

10 ohms to 49 ohms .....±1 ohm  
50 ohms to 5 megohms.....±2%\*  
Above 5 megohms.....±5%

### Power Rating per Resistor

At 70°C .....0.40 watt

### Power Temperature Derating Curve

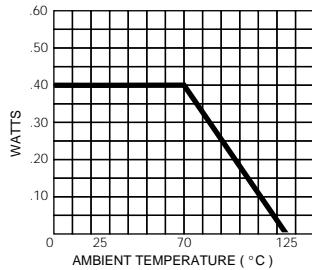

## Bussed Resistors (101 Circuit)

Model 4600M-101-RC  
4 through 14 Pin

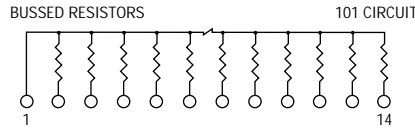

These models incorporate 3 to 13 thick-film resistors of equal value, each connected between a common bus (pin 1) and a separate pin.

### Resistance Tolerance

10 ohms to 49 ohms .....±1 ohm  
50 ohms to 5 megohms .....±2%\*  
Above 5 megohms .....±5%

### Power Rating per Resistor

At 70°C .....0.25 watt

### Power Temperature Derating Curve

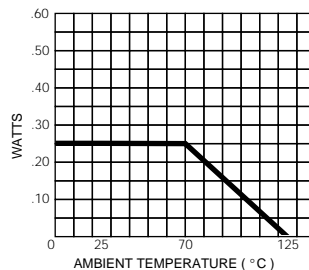

## Dual Terminator (104 Circuit)

Model 4600M-104-R1/R2  
4 through 14 Pin

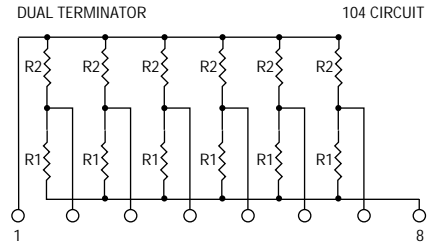

The 4608M-104 (shown above) is an 8-pin configuration and terminates 6 lines. Pins 1 and 8 are common for ground and power, respectively. Twelve thick-film resistors are paired in series between the common lines (pins 1 and 8).

### Resistance Tolerance

Below 100 ohms .....±2 ohms  
100 ohms to 5 megohms .....±2%\*  
Above 5 megohms .....±5%

### Power Rating per Resistor

At 70°C .....0.25 watt

### Power Temperature Derating Curve

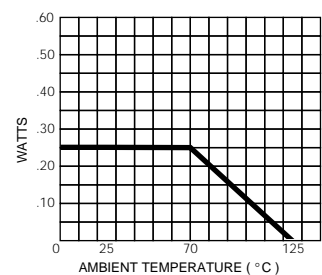

## Popular Resistance Values (101, 102 Circuits)\*\*

Ohms	Code	Ohms	Code	Ohms	Code	Ohms	Code	Ohms	Code
10	100	180	181	1,800	182	15,000	153	120,000	124
22	220	220	221	2,000	202	18,000	183	150,000	154
27	270	270	271	2,200	222	20,000	203	180,000	184
33	330	330	331	2,700	272	22,000	223	220,000	224
39	390	390	391	3,300	332	27,000	273	270,000	274
47	470	470	471	3,900	392	33,000	333	330,000	334
56	560	560	561	4,700	472	39,000	393	390,000	394
68	680	680	681	5,600	562	47,000	473	470,000	474
82	820	820	821	6,800	682	56,000	563	560,000	564
100	101	1,000	102	8,200	822	68,000	683	680,000	684
120	121	1,200	122	10,000	103	82,000	823	820,000	824
150	151	1,500	152	12,000	123	100,000	104	1,000,000	105

\* ±1% TOLERANCE IS AVAILABLE BY ADDING SUFFIX CODE "F" AFTER THE RESISTANCE CODE.

\*\*NON-STANDARD VALUES AVAILABLE, WITHIN RESISTANCE RANGE.

## Popular Resistance Values (104 Circuit)\*\*

Resistance			
(Ohms)		Code	
R <sub>1</sub>	R <sub>2</sub>	R <sub>1</sub>	R <sub>2</sub>
160	240	161	241
180	390	181	391
220	270	221	271
220	330	221	331
330	390	331	391
330	470	331	471
3,000	6,200	302	622

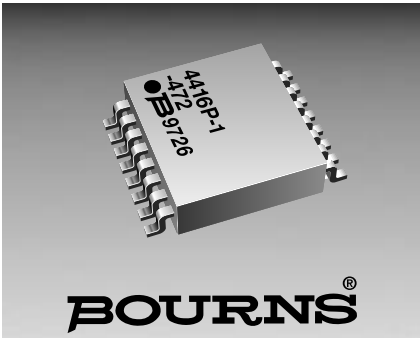

**BOURNS®**

**Features**

- Standard E.I.A. package compatible with automatic placement equipment
- Compliant leads to reduce solder joint fatiguing
- Tape and reel packaging standard (see page 304 for dimensions)
- Marking on contrasting background for permanent identification
- Standard electrical schematics: isolated, bussed, dual terminator
- Custom circuits are available

**4400P Series - Thick Film Surface Mounted Wide Body**

**Product Characteristics**

Resistance Range .....10 ohms to 2.2 megohms  
 Maximum Operating Voltage.....50V  
 Temperature Coefficient of Resistance  
 50 ohms and above.....±100ppm/°C  
 below 50 ohms.....±250ppm/°C  
 TCR Tracking  
 .....50ppm/°C max.; equal values  
 Operating Temperature  
 .....-55°C to +125°C  
 Insulation Resistance  
 .....10,000 megohms min.  
 Dielectric Withstanding Voltage  
 .....200 VRMS  
 Lead Solderability  
 .....Meet requirements of MIL-STD-202 Method 208

**Environmental Characteristics**

TESTS PER MIL-STD-202.....ΔR MAX.  
 Short Time Overload.....±0.25%  
 Load Life .....±1.00%  
 Moisture Resistance .....±0.50%  
 Resistance to Soldering Heat .....±0.25%  
 Thermal Shock.....±0.25%

**Physical Characteristics**

Flammability .....Conforms to UL94V-0  
 Lead Frame Material  
 .....Copper, solder coated  
 Body Material .....Novolac epoxy

**How To Order**

**44 20 P - 1 - 103**

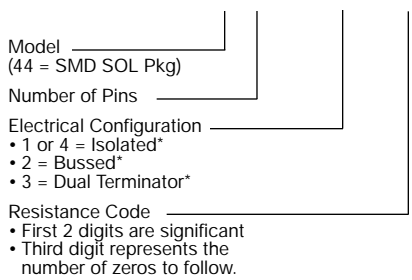

\*For tube packaging, use T01, T02, T03 or T04.  
 Consult factory for other available options.

**Package Power Temp. Derating Curve**

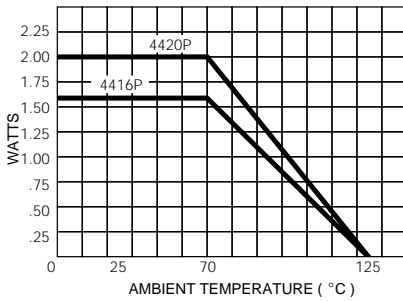

**Package Power Rating at 70°C**

4420P.....2.00 watts  
 4416P.....1.60 watts

**Recommended Land Pattern**

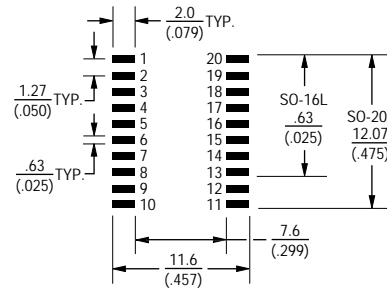

NOTE: Land pattern dimensions are based on design rules established by the Institute for Interconnecting and Packaging Electronic Circuits in IPC-SM-782.

**Product Dimensions**

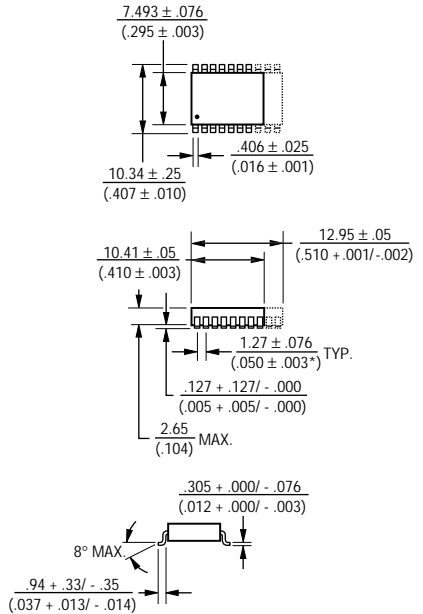

Governing dimensions are in metric. Dimensions in parentheses are inches and are approximate.

\*Terminal centerline to centerline measurements made at point of emergence of the lead from the body.

**Typical Part Marking**

presents total content. Layout may vary.

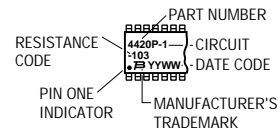



# 4400P Series - Thick Film Surface Mounted Wide Body



## Isolated Resistors (1 And 4 Circuits)

Model 4416P-1  
Model 4420P-1 (Shown)

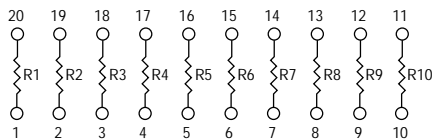

Model 4416P-4  
Model 4420P-4 (Shown)

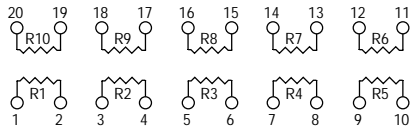

### Resistance Tolerance

10 ohms to 49 ohms .....±1 ohm  
50 ohms to 2.2 megohms.....±2%\*

### Power Rating per Resistor

1 Circuit at 70°C .....0.160 watt  
4 Circuit at 70°C .....0.160 watt

### Resistor Power Temp. Derating Curve

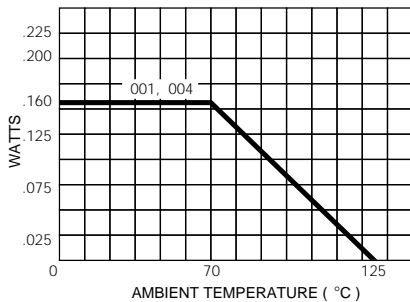

## Bussed Resistors (2 Circuit)

Model 4416P-2  
Model 4420P-2 (Shown)

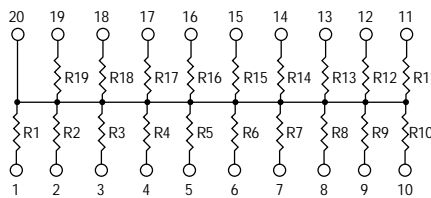

### Resistance Tolerance

10 ohms to 49 ohms .....±1 ohm  
50 ohms to 2.2 megohms .....±2%\*

### Power Rating per Resistor

2 Circuit at 70°C .....0.160 watt

### Resistor Power Temp. Derating Curve

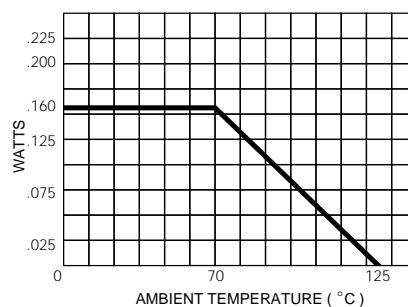

## Dual Terminator (3 Circuit)

Model 4416P-3  
Model 4420P-3 (Shown)

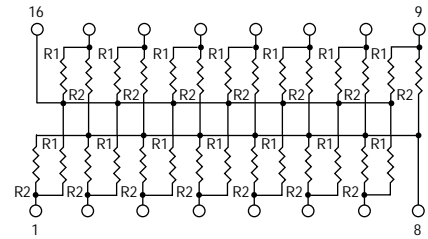

4420P-3 terminates 16 lines,  
convenient for a 16-bit computer bus.

### Resistance Tolerance

Below 100 ohms .....±2 ohms  
100 ohms to 2.2 megohms .....±2%\*

### Power Rating per Resistor

3 Circuit at 70°C .....0.115 watt

### Resistor Power Temp. Derating Curve

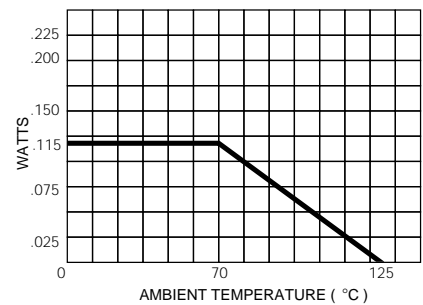

## Popular Resistance Values (1, 4, And 2 Circuits)\*\*

Ohms	Code	Ohms	Code	Ohms	Code	Ohms	Code	Ohms	Code
10	100	180	181	1,800	182	15,000	153	120,000	124
22	220	220	221	2,000	202	18,000	183	150,000	154
27	270	270	271	2,200	222	20,000	203	180,000	184
33	330	330	331	2,700	272	22,000	223	220,000	224
39	390	390	391	3,300	332	27,000	273	270,000	274
47	470	470	471	3,900	392	33,000	333	330,000	334
56	560	560	561	4,700	472	39,000	393	390,000	394
68	680	680	681	5,600	562	47,000	473	470,000	474
82	820	820	821	6,800	682	56,000	563	560,000	564
100	101	1,000	102	8,200	822	68,000	683	680,000	684
120	121	1,200	122	10,000	103	82,000	823	820,000	824
150	151	1,500	152	12,000	123	100,000	104	1,000,000	105

\* ±1% TOLERANCE IS AVAILABLE BY ADDING SUFFIX CODE "F" AFTER THE RESISTANCE CODE.

\*\*NON-STANDARD VALUES AVAILABLE, WITHIN RESISTANCE RANGE.

## Popular Resistance Values (3 Circuit)\*\*

Resistance			
(Ohms)		Code	
R <sub>1</sub>	R <sub>2</sub>	R <sub>1</sub>	R <sub>2</sub>
160	240	161	241
180	390	181	391
220	270	221	271
220	330	221	331
330	390	331	391
330	470	331	471
3,000	6,200	302	622

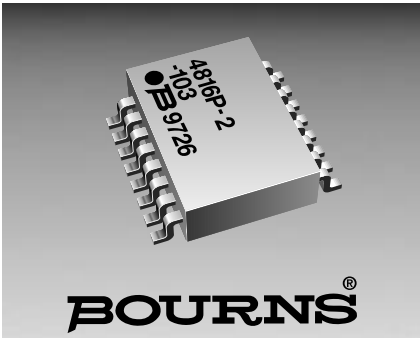

## Features

- Standard E.I.A. package compatible with automatic placement equipment
- Tape and reel packaging standard (see page 304 for dimensions)
- For ordering guidelines, see page 304
- Marking on contrasting background for permanent identification

- Compliant leads to reduce solder joint fatiguing
- Standard electrical schematics: isolated, bussed, dual terminator
- Custom circuits are available

## 4800P Series - Thick Film Surface Mounted Medium Body

### Product Characteristics

Resistance Range .....10 ohms to 2.2 megohms  
 Maximum Operating Voltage.....50V  
 Temperature Coefficient of Resistance  
 50Ω and above.....±100ppm/°C  
 below 50Ω.....±250ppm/°C  
 TCR Tracking  
 .....50ppm/°C max.; equal values  
 100ppm/°C 50W and above  
 Operating Temperature  
 .....-55°C to +125°C  
 Insulation Resistance  
 .....10,000 megohms min.  
 Dielectric Withstanding Voltage  
 .....200 VRMS  
 Lead Solderability  
 ....Meet requirements of MIL-STD-202  
 Method 208

### Environmental Characteristics

TESTS PER MIL-STD-202 .....ΔR MAX.  
 Short Time Overload.....±0.25%  
 Load Life.....±1.00%  
 Moisture Resistance .....±0.50%  
 Resistance to Soldering Heat .....±0.25%  
 Thermal Shock.....±0.25%

### Physical Characteristics

Flammability .....Conforms to UL94V-0  
 Lead Frame Material  
 .....Copper, solder coated  
 Body Material .....Novolac epoxy

### How To Order

48 16 P - 1 - 103

Model \_\_\_\_\_  
 (48 = SOM Pkg)  
 Number of Pins \_\_\_\_\_  
 Electrical Configuration \_\_\_\_\_  
 • 1 or 4 = Isolated\*  
 • 2 = Bussed\*  
 • 3 = Dual Terminator\*  
 Resistance Code \_\_\_\_\_  
 • First 2 digits are significant  
 • Third digit represents the  
 number of zeros to follow.

\*For tube packaging, use T01, T02, T03 or T04.  
 Consult factory for other available options.

### Package Power Temp. Derating Curve

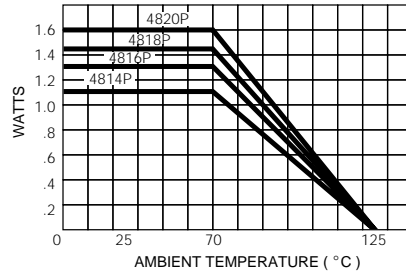

### Package Power Rating at 70°C

4814P	1.12 watts
4816P	1.28 watts
4818P	1.44 watts
4820P	1.60 watts

### Typical Part Marking

Represents total content. Layout may vary.

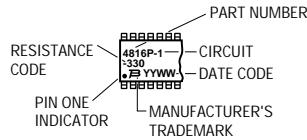

### Recommended Land Pattern

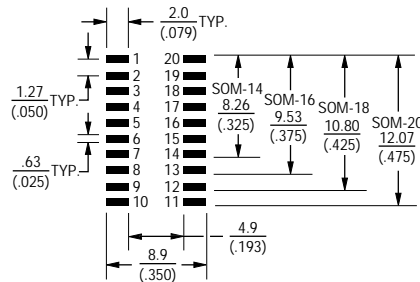

NOTE: Land pattern dimensions are based on design rules established by the Institute for Interconnecting and Packaging Electronic Circuits in IPC-SM-782.

### Product Dimensions

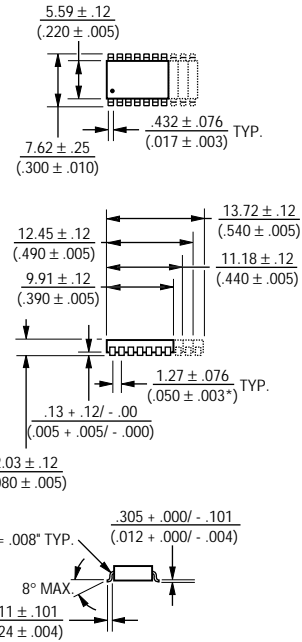

Lead coplanarity .102mm (.004 inch) max. at mounting surface.

Governing dimensions are in metric. Dimensions in parentheses are inches and are approximate.

\*Terminal centerline to centerline measurements made at point of emergence of the lead from the body.

# 4800P Series - Thick Film Surface Mounted Medium Body



## Isolated Resistors (1 And 4 Circuits)

Model 4814P-1  
 Model 4816P-1 (Shown)  
 Model 4818P-1  
 Model 4820P-1

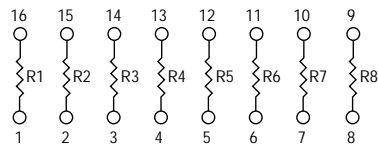

Model 4816P-4 (Shown)  
 Model 4820P-4

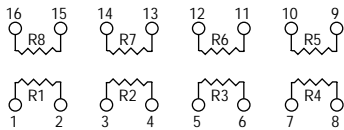

### Resistance Tolerance

10 ohms to 49 ohms .....±1 ohm  
 50 ohms to 2.2 megohms.....±2%\*

### Power Rating per Resistor

1 Circuit at 70°C .....0.160 watt  
 4 Circuit at 70°C .....0.160 watt

### Resistor Power Temp. Derating Curve

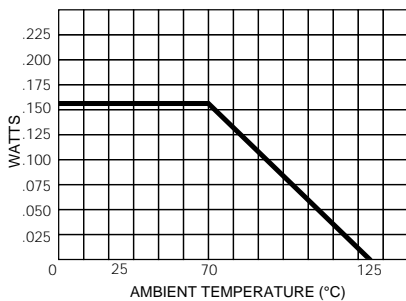

## Bussed Resistors (2 Circuit)

Model 4814P-2  
 Model 4816P-2 (Shown)  
 Model 4818P-2  
 Model 4820P-2

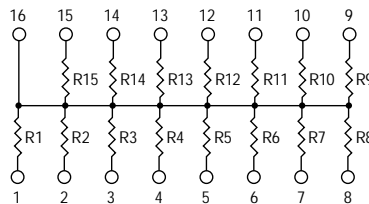

### Resistance Tolerance

10 ohms to 49 ohms .....±1 ohm  
 50 ohms to 2.2 megohms .....±2%\*

### Power Rating per Resistor

2 Circuit at 70°C .....0.080 watt

### Resistor Power Temp. Derating Curve

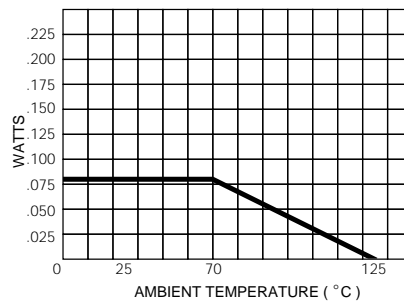

## Dual Terminator (3 Circuit)

Model 4814P-3  
 Model 4816P-3 (Shown)  
 Model 4818P-3  
 Model 4820P-3

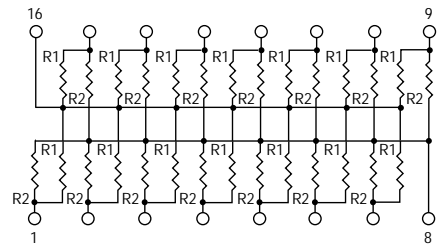

### Resistance Tolerance

Below 100 ohms .....±2 ohms  
 100 ohms to 2.2 megohms .....±2%\*

### Power Rating per Resistor

3 Circuit at 70°C .....0.080 watt

### Resistor Power Temp. Derating Curve

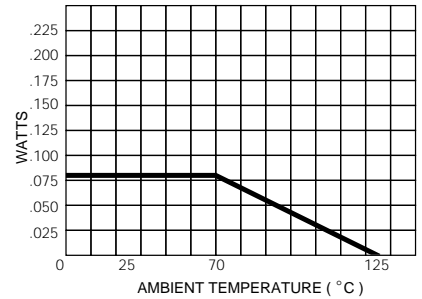

## Popular Resistance Values (1, 4, And 2 Circuits)\*\*

Ohms	Code	Ohms	Code	Ohms	Code	Ohms	Code	Ohms	Code
10	100	180	181	1,800	182	15,000	153	120,000	124
22	220	220	221	2,000	202	18,000	183	150,000	154
27	270	270	271	2,200	222	20,000	203	180,000	184
33	330	330	331	2,700	272	22,000	223	220,000	224
39	390	390	391	3,300	332	27,000	273	270,000	274
47	470	470	471	3,900	392	33,000	333	330,000	334
56	560	560	561	4,700	472	39,000	393	390,000	394
68	680	680	681	5,600	562	47,000	473	470,000	474
82	820	820	821	6,800	682	56,000	563	560,000	564
100	101	1,000	102	8,200	822	68,000	683	680,000	684
120	121	1,200	122	10,000	103	82,000	823	820,000	824
150	151	1,500	152	12,000	123	100,000	104	1,000,000	105

\* ±1% TOLERANCE IS AVAILABLE BY ADDING SUFFIX CODE "F" AFTER THE RESISTANCE CODE.

\*\*NON-STANDARD VALUES AVAILABLE, WITHIN RESISTANCE RANGE.

## Popular Resistance Values (3 Circuit)\*\*

Resistance			
(Ohms)		Code	
R <sub>1</sub>	R <sub>2</sub>	R <sub>1</sub>	R <sub>2</sub>
160	240	161	241
180	390	181	391
220	270	221	271
220	330	221	331
330	390	331	391
330	470	331	471
3,000	6,200	302	622

# Surface Mounted Ordering Guide



Electrical Configuration	*Circuit Codes		Examples
	Tape & Reel	Tubes	
Isolated	1	T01	4816P-1-101
Bussed	2	T02	Isolated Circuit in Tape & Reel Package
Dual Terminated	3	T03	4816P-T01-101
Adj. Isolated	4	T04	Isolated Circuit in Slide Tube Package

\*4816P-X-RC: To specify package type, replace "X" with appropriate "Circuit Code".

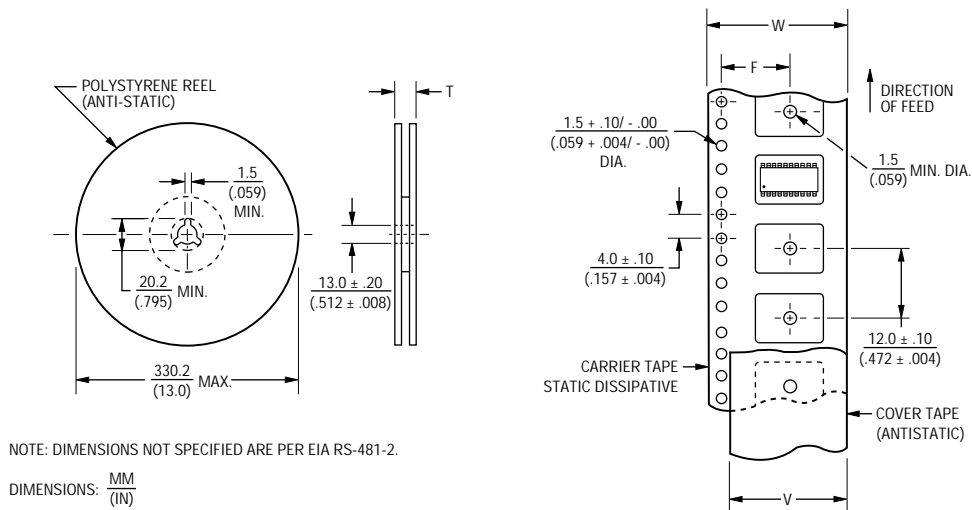

Model	Standard Quantity Per Reel	Carrier Tape Width (W)	Cover Tape Width (V)	Reel Width (T)	Pocket Center (F)
4416P	1,500	$24.0 \pm .30$ (.945 ± .012)	$21.0$ (.827) NOM.	$30.4$ (1.197) MAX.	$11.5 \pm .10$ (.453 ± .004)
4420P	1,500				
4814P 4816P 4818P 4820P	2,000				
4908P 4914P 4916P	2,500	12mm 12mm 16mm	Contact Factory	Contact Factory	8mm 8mm 8mm

Leader Length = 500 min.  
 Trailer Length = 500mm min.

} Empty Component Pockets  
 Sealed with Cover Tape



## Features

- Cost effective R-C construction
- Insulation resistance testing for reliability
- Molded surface mount or DIP packaging
- Compatible with automatic assembly equipment
- Custom value capability

## 601 Series - RC Networks T-Filters

### General Description

Continual advances in digital IC technology are creating stringent demands on EMI/RFI levels in equipment.

EMI/RFI low pass filters are required in personal computers, data terminals, test equipment and process controllers for high frequency suppression into or out of electronic equipment.

For additional information, see application note on pages 320 and 321.

### Electrical Specifications - Resistors

Standard Resistance Range*	10 ohms - 100 ohms
Series Resistance Tolerance	±10%
Temperature Coefficient of Resistance	±300ppm/°C
Operating Voltage	25 volts maximum
Operating Temperatures	+10°C to +85°C

\*Other Resistance Values Available, 10 ohms - 1 megohm

### Electrical Specifications - Capacitors

Standard Capacitance Range	50pF to 200pF
Capacitance Tolerance	±30%
Temperature Characteristic	Z5U
Operating Temperatures	+10°C to +85°C
Voltage Rating	25 volts
Dielectric Withstand Voltage	2.5 x rated voltage
Insulation Resistance	10,000 megohms minimum

### Environmental Specifications - Resistors

	$\Delta R$ MAXIMUM
Thermal Shock	±0.5%
Resistance to Solder Heat	±0.5%
Terminal Strength	±0.5%

### Mechanical Specifications

Flammability	Conforms to UL94 V-0
Leadframe	Copper, solder coated
Body Material	Epoxy/Novolac
Lead Solderability	Meet requirements of MIL-STD-202 Method 208

### 4420P

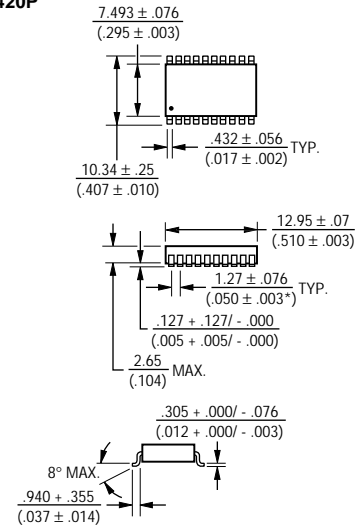

### 4118R AND 4120R

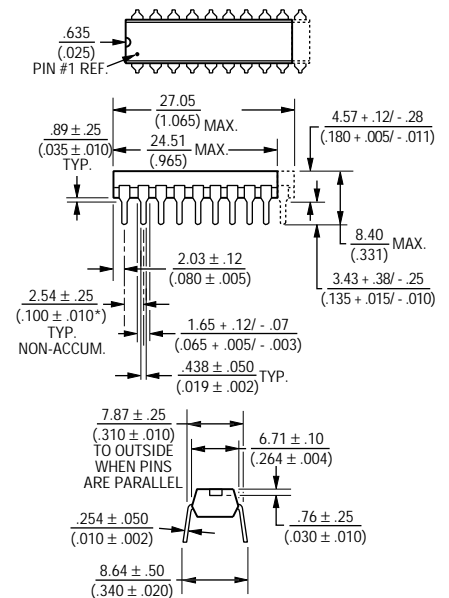

Governing dimensions are metric. Dimensions in parentheses are inches and are approximate.

\*Terminal centerline to centerline measurements made at point of emergence of the lead from the body.

# 601 Series - RC Networks T-Filters



## Attenuation Vs. Frequency - Typical Capacitor Values With R= 25 Ohms

Attenuation vs. Frequency  
 Model 4120R-601-250/500  
 Model 4420-601-250/500  
 50pF - 3dB @ 84 MHz

Attenuation vs. Frequency  
 Model 4120R-601-250/201  
 Model 4420P-601-250/201  
 200pF - 3dB @ 21 MHz

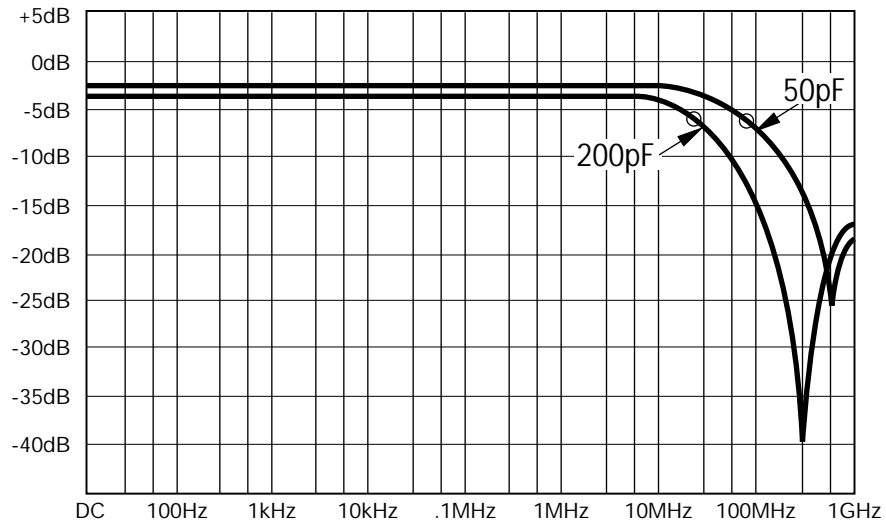

○ indicates - 3dB rolloff frequency ( $f_c$ )

These low-pass filters are ideal for installation between I/O drivers and RS 232 connectors.

## Typical Circuit

4120R-601-RC/CC  
 4420R-601-RC/CC

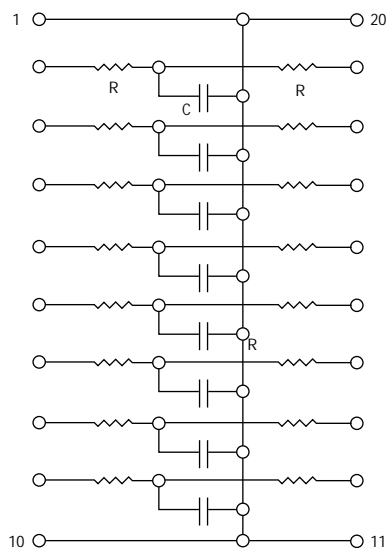

## How To Order EMI/RFI Filter Networks

44 20 P - 601 - RC/CC

Model \_\_\_\_\_  
 (44 = SMD SOIC Pkg)  
 (41 = Molded DIP)

Number of Pins \_\_\_\_\_

Physical Configuration \_\_\_\_\_  
 P = Surface Mount Device (SMD)  
 R = Molded DIP

Resistance/Capacitance Code \_\_\_\_\_  
 • First 2 digits are significant  
 • Third digit represents the number of zeros to follow

Electrical Configuration \_\_\_\_\_

Insert RC/CC Code from table below to form part number.

RC	R	CC	C
250	25Ω	500	50pF
270	27Ω	101	100pF
470	47Ω	181	180pF
820	82Ω	201	200pF
101	100Ω		

CONSULT FACTORY FOR VALUES NOT LISTED

## Packages Available

4420P-601-\*RC/CC-SMD  
 4120R-601-\*RC/CC-DIP  
 4118R-601-\*RC/CC-DIP

\*First two digits are significant. Third digit represents the number of zeros to follow.

Seven circuits in an 18-pin package.  
 Eight circuits in a 20-pin package.

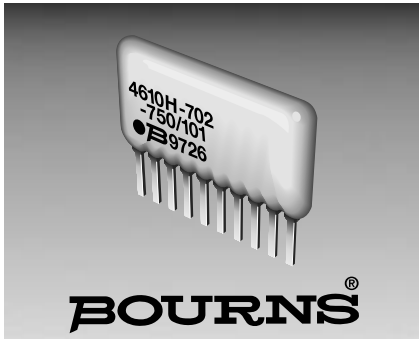

## Features

- Low noise termination for CMOS
- Combined resistors and capacitors in SIP package saves space
- Reduced insertion time
- Insulation resistance testing for reliability
- Pin counts from 4 to 16 available

# 700 Series - RC Terminator Networks

### Electrical Characteristics - Resistors

Standard Resistance Range .....22 ohms to 500K ohms  
 Resistance Tolerance  $\pm 5\%$  .....50 ohms to 1 megohm  
 Operating Voltage .....50 volts maximum

### Electrical Characteristics - Capacitors

Capacitance Range .....39 pF to 47,000 pF  
 Capacitance Range .....470 pF to 47,000 pF X7R  
 Capacitance Range.....39pF to 470pF NPO  
 Capacitance Tolerance ..... $\pm 20\%$   
 Operating Temperature.....-30°C to +85°C  
 Voltage Rating.....50 volts

### Physical Characteristics

Flammability .....Conforms to UL 94 V-0  
 Lead Frame Material.....Copper, solder coated  
 Body Material .....Conformal coat

### Typical Part Marking

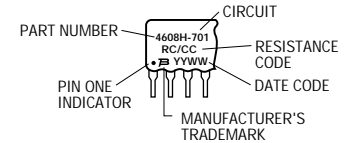

### Product Dimensions

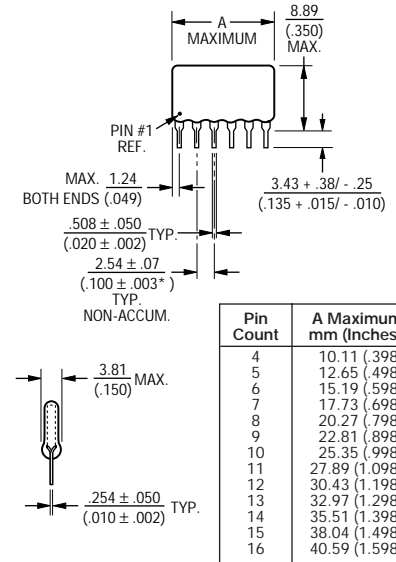

Governing dimensions are metric. Dimensions in parentheses are inches and are approximate.

\*Terminal centerline to centerline measurements made at point of emergence of the lead from the body.

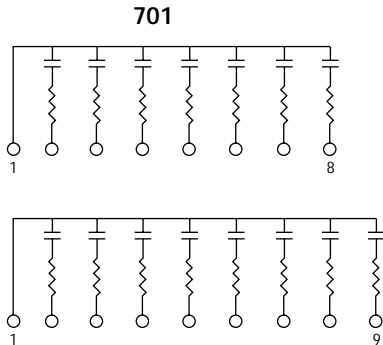

NO. OF LINES	BOURNS P/N	PACKAGE
7	4608H-701-RC/CC	High Profile Conformal SIP
8	4609H-701-RC/CC	
9	4610H-701-RC/CC	

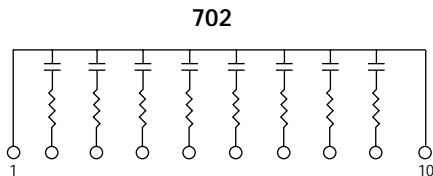

NO. OF LINES	BOURNS P/N	PACKAGE
8	4610H-702-RC/CC	High Profile Conformal SIP

FOR ADDITIONAL INFORMATION, SEE APPLICATION NOTE ON PAGES 322 AND 323.

## Additional Features

- Prevent bus lines and control signals from floating to undefined logic levels.
- Optimize signal transmission in high performance systems through proper termination.
- Eliminate overshoot and ringing, increase noise immunity, minimize signal distortion, and lower EMI/RFI radiation.
- Minimize space and routing problems, and reduce manufacturing cost per installed resistive function.
- Increase board yields and reliability by reducing component count.

# 700 Series - Resistor Networks RC Terminator Networks

# BOURNS®

Standard Resistance Values And Codes

Resistance (Ohms)	Resistance Code	Resistance (Ohms)	Resistance Code
22	220	5,600	562
27	270	6,800	682
33	330	8,200	822
39	390	10,000	103
47	470	12,000	123
56	560	15,000	153
68	680	18,000	183
82	820	20,000	203
100	101	22,000	223
120	121	27,000	273
150	151	33,000	333
180	181	39,000	393
220	221	47,000	473
270	271	56,000	563
330	331	68,000	683
390	391	82,000	823
470	471	100,000	104
560	561	120,000	124
680	681	150,000	154
820	821	180,000	184
1,000	102	220,000	224
1,200	122	270,000	274
1,500	152	330,000	334
1,800	182	390,000	394
2,000	202	470,000	474
2,200	222		
2,700	272		
3,300	332		
3,900	392		

Values not appearing in above tables are available to optimize system performance. Contact Bourns Networks to inquire.

Standard Capacitance Values And Codes

Capacitance	Capacitance Code	Capacitance	Capacitance Code
39pF	390	1000pF	102
47	470	1200	122
56	560	1500	152
68	680	1800	182
82	820	2200	222
100	101	2700	272
120	121	3300	332
150	151	3900	392
180	181	4700	472
220	221	5600	562
270	271	6800	682
330	331	8200	822
390	391	.010µF	103
470	471	.012	123
560	561	.015	153
680	681	.018	183
820	821	.022	223
		.027	273
		.033	333
		.039	393
		.047	473

## How To Order RC Terminator Networks

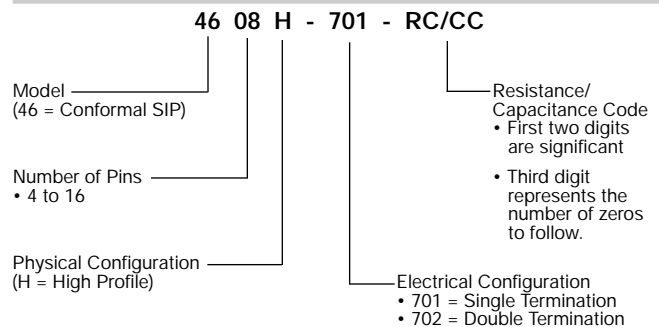



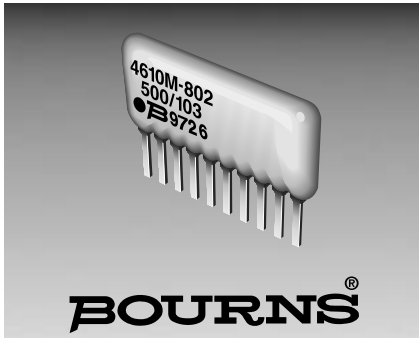

## Features

- Optimize data transmission in ECL systems through proper termination between drivers and receivers
- Minimize overshoot, undershoot, and ringing while increasing noise immunity
- Provide decoupling capacitors

- Minimize space and routing problems, and reduce manufacturing cost per installed resistive function
- Increase board yields and reliability by reducing component count

# 800 Series - RC Networks ECL Terminator Circuits

## General Description

Digital systems incorporating Emitter Coupled Logic (ECL) or other ultra-high switching speed logic families will require signal termination to prevent transmission line effects such as reflections and ringing due to fast transition times.

Bourns 800 series resistor capacitor networks are ideal for termination of high speed transmission lines. Each network is composed of resistors for parallel termination and bypass capacitor(s) for cross talk noise reduction.

The 5 conformal coated SIP circuit variations offered are as follows.

## Electrical Characteristics

Resistance Tolerance .....±5%  
 Resistance Power .....0.1 watt  
 Capacitance Tolerance .....±20%  
 Capacitor Dielectric Type.....X7R  
 Capacitance Voltage Rating .....50 Volts

## Physical Characteristics

Flammability .....Conforms to UL94V-0  
 Leadframe .....Copper (Olin 194)  
 Body Material.....Epoxy/Anhydride  
 (Conformal Material)  
 Custom Resistance Range  
 .....10 ohms to 50K ohms  
 Custom Capacitance Range  
 .....39pF to 100,000pF

NPO and Z5U dielectrics available on a custom basis.

## Product Dimensions

### MEDIUM PROFILE

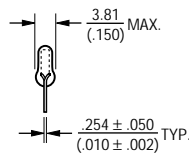
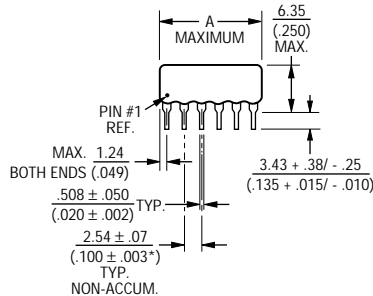

### HIGH PROFILE

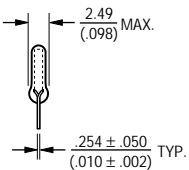
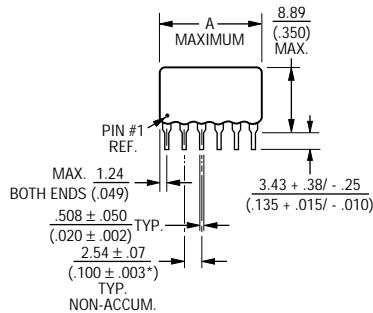

Governing dimensions are metric. Dimensions in parentheses are inches and are approximate.

\*Terminal centerline to centerline measurements made at point of emergence of the lead from the body.

## Typical Part Marking

801 AND 802  
 Represents total content. Layout may vary.

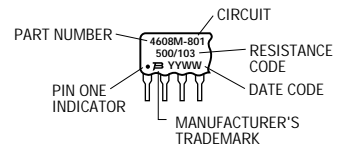

803 AND 805  
 Represents total content. Layout may vary.

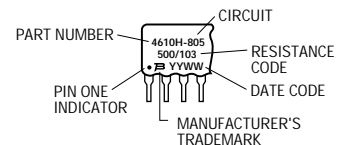

804  
 Represents total content. Layout may vary.

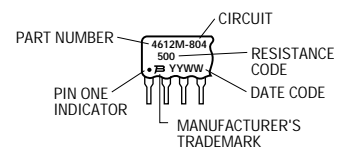

# 800 Series - RC Networks ECL Terminator Circuits



## 801 8, 10 and 12 Pin SIP

(4608M-801-RC/CC)

Designed to terminate 6 to 10 transmission lines using parallel termination techniques. Standard resistance values include 50, 68, 75, 82, 90 or 100 ohms and are chosen to match the characteristic impedance ( $Z_0$ ) of the transmission line. A 0.01 mF capacitor is provided to help maintain a solid power supply level within the network package, mitigating any cross talk or feedthrough effects. Values for R and C not shown in the following table are available on a custom basis.

### Standard 801 Part Numbers

R ±2%	C ±20%	Bourns Part Number
50Ω	0.01μF	4608M-801-500/103
68Ω	0.01μF	4608M-801-680/103
75Ω	0.01μF	4608M-801-750/103
82Ω	0.01μF	4608M-801-820/103
90Ω	0.01μF	4608M-801-900/103
100Ω	0.01μF	4608M-801-101/103

### 801 Electrical Schematic and Application

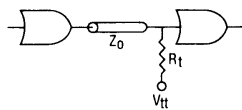
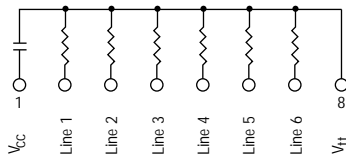

## 802 10 Pin SIP

(4610M-802-RC/CC)

Designed to terminate 6 transmission lines using parallel termination techniques. Popular resistance values include 50, 68, 75, 82, 90 or 100 ohms and are chosen to match the characteristic impedance ( $Z_0$ ) of the transmission line. Two 0.01 μF capacitors are provided to reduce cross talk between lines and to decrease network package inductance. Values for R and C not shown in the following table are available on a custom basis.

### Standard 802 Part Numbers

R ±2%	C ±20%	Bourns Part Number
50Ω	0.01μF	4610M-802-500/103
68Ω	0.01μF	4610M-802-680/103
75Ω	0.01μF	4610M-802-750/103
82Ω	0.01μF	4610M-802-820/103
90Ω	0.01μF	4610M-802-900/103
100Ω	0.01μF	4610M-802-101/103

### 802 Electrical Schematic and Application

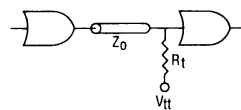
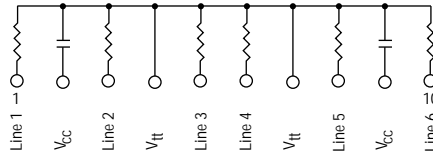

## 803 8, 10 and 12 Pin SIP 10K ECL

(4610H-803-ZoC/CC)

Designed to terminate 6 to 10 transmission lines using Thevenin equivalent parallel termination techniques in systems using 10K ECL. Popular impedance values include 50, 70, 75, 80, 90, 100, 120, 150 or 200 ohms. Standard values for R1 and R2, based on  $Z_0$ , have been chosen to accommodate 10K ECL designs. A 0.1 μF capacitor is provided to reduce cross talk noise within the network package. Values for  $Z_0$  and C not shown in the following table are available on a custom basis. This type of termination is an alternative to parallel termination used when a separate  $V_{tt}$  power supply is not available.

### Standard 803 Part Numbers

$Z_0$ ±2%	R1	R2	C ±20%	Bourns Part No.
50Ω	81Ω	130Ω	0.1μF	4610H-803-500/104
70Ω	113Ω	182Ω	0.1μF	4610H-803-700/104
75Ω	121Ω	195Ω	0.1μF	4610H-803-750/104
80Ω	130Ω	208Ω	0.1μF	4610H-803-800/104
90Ω	146Ω	234Ω	0.1μF	4610H-803-900/104
100Ω	162Ω	260Ω	0.1μF	4610H-803-101/104
120Ω	194Ω	312Ω	0.1μF	4610H-803-121/104
150Ω	243Ω	390Ω	0.1μF	4610H-803-151/104
200Ω	325Ω	520Ω	0.1μF	4610H-803-201/104

### 803 Electrical Schematic and Application

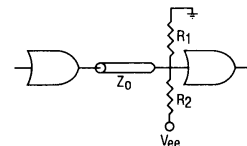
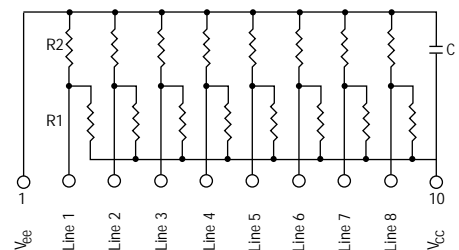

# 800 Series - RC Networks ECL Terminator Circuits



## 804 12 Pin SIP ECL

(4612M-804-RC)

Designed to terminate 6 transmission lines using parallel termination techniques. Popular resistance values include 50 or 100 ohms. A 0.1  $\mu\text{F}$  capacitor is provided for connection to  $V_{\text{ee}}$ . Two 0.01  $\mu\text{F}$  capacitors are provided for connection to  $V_{\text{tt}}$ . Values for R and C not shown in the following table are available on a custom basis.

### Standard 804 Part Numbers

R $\pm 2\%$	Ct $\pm 20\%$	Ce $\pm 20\%$	Bourns Part Number
50 $\Omega$	0.01 $\mu\text{F}$	0.1 $\mu\text{F}$	4612M-804-500
100 $\Omega$	0.01 $\mu\text{F}$	0.1 $\mu\text{F}$	4612M-804-101

### 804 Electrical Schematic and Application

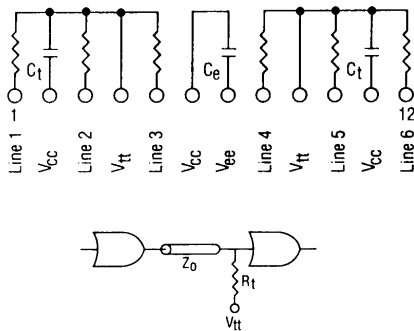

## 805 8, 10 and 12 Pin SIP 100K ECL

(4610H-805-ZoC/CC)

Designed to terminate 6 to 10 transmission lines using Thevenin equivalent parallel termination techniques in systems using 100K ECL. Popular impedance values include 50, 70, 75, 80, 90, 100, 120, 150 or 200 ohms. Standard values for R1 and R2, based on  $Z_0$ , have been chosen to accommodate 100K ECL designs. A 0.1  $\mu\text{F}$  capacitor is provided to reduce cross talk noise within the network package. Values for  $Z_0$  and C not shown in the following table are available on a custom basis. This type of termination is an alternative to parallel termination used when a separate  $V_{\text{tt}}$  power supply is not available.

### Standard 805 Part Numbers

Zo $\pm 2\%$	R1	R2	C $\pm 20\%$	Bourns Part No.
50 $\Omega$	90 $\Omega$	113 $\Omega$	0.1 $\mu\text{F}$	4610H-805-500/104
70 $\Omega$	126 $\Omega$	158 $\Omega$	0.1 $\mu\text{F}$	4610H-805-700/104
75 $\Omega$	135 $\Omega$	169 $\Omega$	0.1 $\mu\text{F}$	4610H-805-750/104
80 $\Omega$	144 $\Omega$	180 $\Omega$	0.1 $\mu\text{F}$	4610H-805-800/104
90 $\Omega$	161 $\Omega$	202 $\Omega$	0.1 $\mu\text{F}$	4610H-805-900/104
100 $\Omega$	180 $\Omega$	225 $\Omega$	0.1 $\mu\text{F}$	4610H-805-101/104
120 $\Omega$	216 $\Omega$	270 $\Omega$	0.1 $\mu\text{F}$	4610H-805-121/104
150 $\Omega$	270 $\Omega$	338 $\Omega$	0.1 $\mu\text{F}$	4610H-805-151/104
200 $\Omega$	360 $\Omega$	450 $\Omega$	0.1 $\mu\text{F}$	4610H-805-201/104

### 805 Electrical Schematic and Application

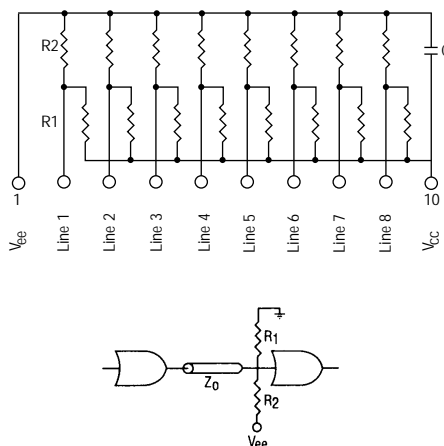

### How To Order 801

46 08 M - 801 - 500 103

Model \_\_\_\_\_  
(46 = Conformal SIP)  
Number of Pins \_\_\_\_\_  
(8, 10, 12)  
Physical Config. \_\_\_\_\_  
•M = Medium Profile  
Electrical Configuration \_\_\_\_\_  
Resistance Code \_\_\_\_\_  
•First 2 digits are significant  
•Third digit represents the number of zeros to follow.  
•Units = ohms  
Capacitance Code \_\_\_\_\_  
•First 2 digits are significant  
•Third digit represents the number of zeros to follow.  
•Units = picofarads  
Consult factory for other available options.

### How To Order 802

46 10 M - 802 - 500 103

Model \_\_\_\_\_  
(46 = Conformal SIP)  
Number of Pins \_\_\_\_\_  
(8, 10, 12)  
Physical Config. \_\_\_\_\_  
•M = Medium Profile  
Electrical Configuration \_\_\_\_\_  
Resistance Code \_\_\_\_\_  
•First 2 digits are significant  
•Third digit represents the number of zeros to follow.  
•Units = ohms  
Capacitance Code \_\_\_\_\_  
•First 2 digits are significant  
•Third digit represents the number of zeros to follow.  
•Units = picofarads  
Consult factory for other available options.

### How To Order 803 and 805

46 08 H - 803 - 101 103

Model \_\_\_\_\_  
(46 = Conformal SIP)  
Number of Pins \_\_\_\_\_  
(8, 10, 12)  
Physical Config. \_\_\_\_\_  
•H = High Profile  
Electrical Configuration \_\_\_\_\_  
•803 •805  
Impedance Code \_\_\_\_\_  
•First 2 digits are significant  
•Third digit represents the number of zeros to follow.  
•Units = ohms  
Capacitance Code \_\_\_\_\_  
•First 2 digits are significant  
•Third digit represents the number of zeros to follow.  
•Units = picofarads  
Consult factory for other available options.

### How To Order 804

46 12 M - 804 - 500

Model \_\_\_\_\_  
(46 = Conformal SIP)  
Number of Pins \_\_\_\_\_  
Physical Config. \_\_\_\_\_  
•M = Medium Profile  
Electrical Configuration \_\_\_\_\_  
Resistance Code \_\_\_\_\_  
•First 2 digits are significant  
•Third digit represents the number of zeros to follow.  
•Units = ohms  
Consult factory for other available options.

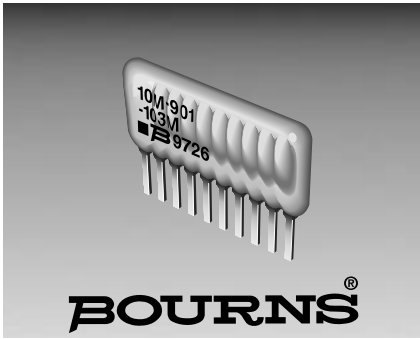

## Features

- Integrates capacitor function in one package
- Design reduces termination noise
- Popular standard capacitance values available
- Isolated and bussed circuits available

- High temperature lead attachment to withstand reflow temperatures up to 260°C

# 900 Series - Capacitor Networks

### Electrical Characteristics

Capacitance Tolerance  
 39 pF - 270 pF.....±10%  
 >270 pF - 0.1 μF.....±20%  
 Circuit Configuration...Isolated & bussed  
 Capacitor Dielectric.....NPO, X7R  
 Capacitance Voltage Rating  
 39 pF - 270 pF  
 .....NPO - 50V @ +25°C  
 >270 pF - 0.047 μF  
 .....X7R - 50V @ +25°C

### Physical Characteristics

Lead Spacing.....0.100" (2.54 mm)  
 Lead Frame Material  
 .....Copper, solder coated  
 Body Material  
 ....Epoxy/Anhydride conformal material

Z5U dielectrics available on a custom basis.

### Standard High Volume Part Numbers

- 4610M-901-103
- 4610M-902-103
- 4610M-901-104
- 4610M-902-104

### How To Order

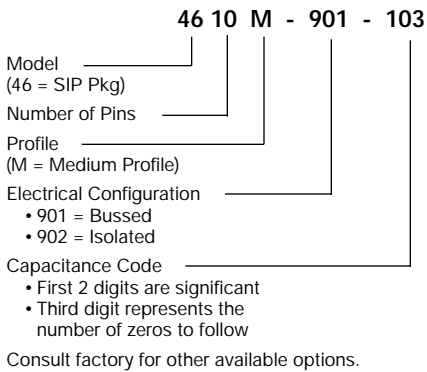

### Product Dimensions

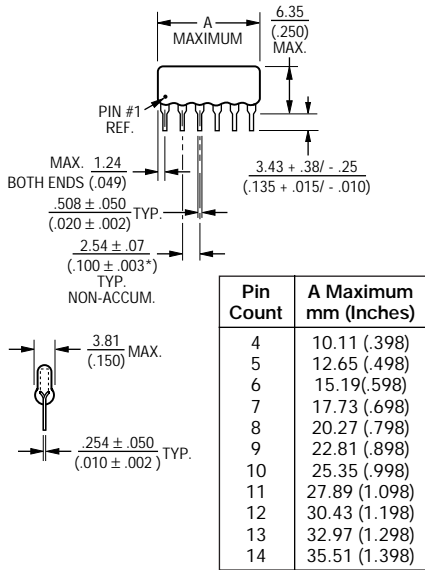

### Typical Part Marking

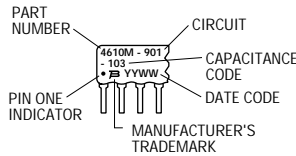

### Standard Capacitance Values and Codes

These are the standard and non-standard capacitance values available. Consult factory for capacitance values and types outside this range. Tolerances of 5%, 10% and 20% are available.

"NPO" DIELECTRICS 10% Tolerance		"X7R" DIELECTRICS 20% Tolerance		"X7R" DIELECTRICS 20% Tolerance	
Capacitance (pF)	Capacitance Code	Capacitance (pF)	Capacitance Code	Capacitance (μF)	Capacitance Code
39	390	330	331	0.01	103
47	470	390	391	0.012	123
56	560	470	471	0.015	153
68	680	560	561	0.018	183
82	820	680	681	0.022	223
100	101	820	820	0.027	273
120	121	1000	102	0.033	333
150	151	1200	122	0.039	393
180	181	1500	152	0.047	473
220	221	1800	182	0.056	563
270	271	2200	222	0.068	683
		2700	272	0.082	823
		3300	332	0.1	104
		3900	392		
		4700	472		
		5600	562		
		6800	682		
		8200	822		

### Isolated Capacitors (902 Circuit)

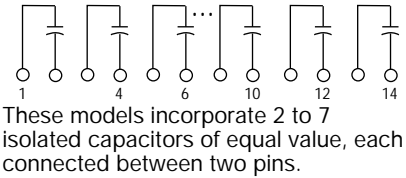

### Bussed Capacitors (901 Circuit)

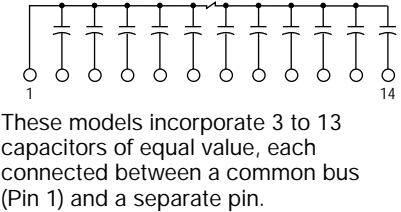

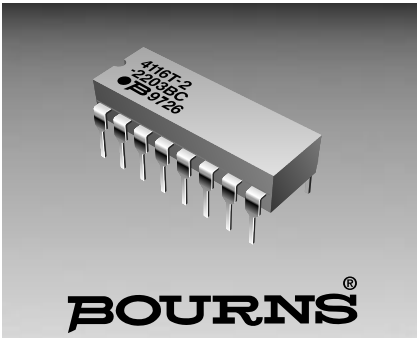

**BOURNS®**

## Features

- Custom circuits available per factory

# 4100T - Thin Film Molded DIP

### Product Characteristics

Resistance Range .....50 to 100K ohms  
 Resistance Tolerance  
 .....±0.1%, ±0.5%, ±1%  
 Temperature Coefficient  
 .....±100ppm/°C, ±50ppm/°C,  
 ±25ppm/°C  
 Temperature Range  
 .....-55°C to +125°C  
 Insulation Resistance  
 .....10,000 megohms minimum  
 TCR Tracking .....±5ppm/°C  
 Maximum Operating Voltage.....50V

### Environmental Characteristics

TESTS PER MIL-STD-202..... ΔR MAX.  
 Thermal Shock ..... 0.1%  
 Low Temperature Operation ..... 0.25%  
 Short Time Overload ..... 0.1%  
 Resistance to Soldering Heat ..... 0.1%  
 Moisture Resistance ..... 0.1%  
 Mechanical Shock..... 0.25%  
 Life ..... 0.5%  
 High Temperature Storage ..... 0.2%  
 Low Temperature Storage..... 0.1%

### Physical Characteristics

Lead Frame Material  
 .....Copper, solder coated  
 Body Material Flammability  
 .....Conforms to UL94V-0  
 Body Material .....Novolac Epoxy

### How To Order

**41 16 T - 2 - 2222 F A B**

Model \_\_\_\_\_  
 (41 = Molded Dip)  
 Number of Pins \_\_\_\_\_  
 Physical Config. \_\_\_\_\_  
 •T = Thin Film  
 Electrical Configuration \_\_\_\_\_  
 •2 = Bussed      •1 = Isolated  
 Resistance Code \_\_\_\_\_  
 •First 3 digits are significant  
 •Fourth digit represents the  
 number of zeros to follow.  
 Absolute Tolerance Code \_\_\_\_\_  
 •B = ±0.1%      •F = ±1%  
 •D = ±0.5%  
 Temperature Coefficient Code \_\_\_\_\_  
 •A = ±100ppm/°C    •C = ±25ppm/°C  
 •B = ±50ppm/°C  
 Ratio Tolerance (Optional) \_\_\_\_\_  
 •A = ±0.05% to R1    •B = ±0.1% to R1  
 •D = ±0.5% to R1  
 Consult factory for other available options.

### PACKAGE POWER TEMPERATURE DERATING CURVE (4100T-1)

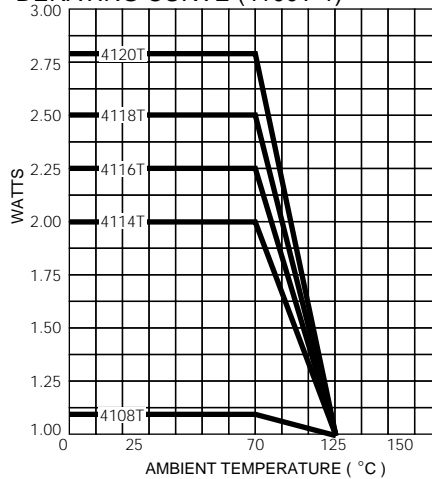

### Package Power Ratings at 70°C

4108T	1.09 watts
4114T	2.00 watts
4116T	2.25 watts
4118T	2.50 watts
4120T	2.80 watts

### Typical Part Marking

Represents total content. Layout may vary.

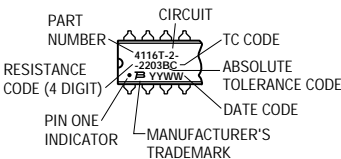

### Isolated Resistors (1 Circuit)

Available in 8, 14, 16, 18, and 20 Pin

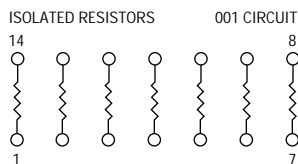

These models incorporate 4, 7, 8, 9, or 10 thin-film resistors of equal value, each connected between a separate pin.

Power Rating per Resistor.....0.2 watt  
 Resistance Range .....50 to 100K ohms

### Product Dimensions

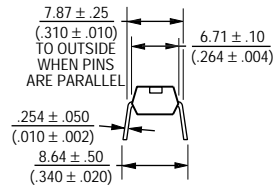
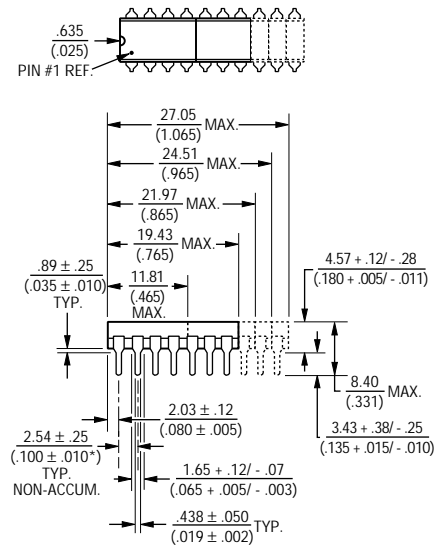

Governing dimensions are in metric. Dimensions in parentheses are inches and are approximate.

\*Terminal centerline to centerline measurements made at point of emergence of the lead from the body.

### Bussed Resistors (2 Circuit)

Available in 8, 14, 16, 18, and 20 Pin

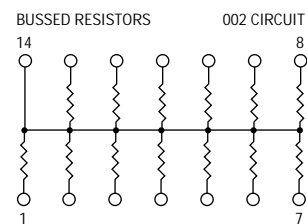

These models incorporate 7, 13, 15, 17, or 19 thin-film resistors of equal value, each connected by a common pin.

Power Rating per Resistor.....0.12 watt  
 Resistance Range .....50 to 50K ohms

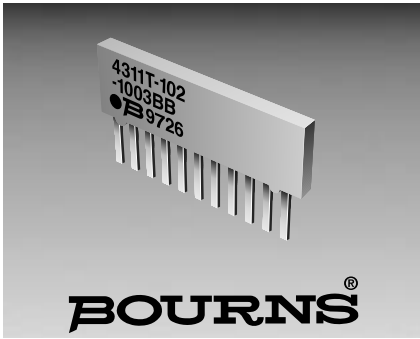

## Features

- Low profile provides compatibility with DIPs
- Also available in medium profile (4300S - .250") and high profile (4300K - .350")
- Marking on contrasting background
- Custom circuits available per factory

## 4300T, S, K Series - Thin Film Molded SIP

### Product Characteristics

Resistance Range  
 Bussed .....49.9 to 100K ohms  
 Isolated .....20 to 200K ohms  
 Series .....20 to 100K ohms

Resistance Tolerance  
 .....±0.1%, ±0.5%, ±1%

Temperature Coefficient  
 .....±100ppm/°C, ±50ppm/°C,  
 .....±25ppm/°C

Temperature Range .....-55°C to +125°C

Insulation Resistance  
 .....10,000 megohms minimum

TCR Tracking .....±5ppm/°C

Maximum Operating Voltage .....50V

### Environmental Characteristics

Thermal Shock and  
 Power Conditioning ..... 0.1%  
 Short Time Overload ..... 0.1%  
 Terminal Strength ..... 0.25%  
 Resistance to Soldering Heat ..... 0.1%  
 Moisture Resistance ..... 0.1%  
 Life ..... 0.50%

### Physical Characteristics

Body Material Flammability  
 .....Conforms to UL94V-0

Lead Frame Material  
 .....Copper, solder coated

Body Material .....Novolac epoxy

### How To Order

**43 11 T - 101 - 2222 F A B**

Model \_\_\_\_\_  
 (43 = Molded SIP)

Number of Pins \_\_\_\_\_

Physical Config.  
 • T = Low Profile Thin Film  
 • S = Medium Profile Thin Film  
 • K = High Profile Thin Film

Electrical Configuration \_\_\_\_\_  
 • 101 = Bussed  
 • 102 = Isolated  
 • 106 = Series

Resistance Code \_\_\_\_\_  
 • First 3 digits are significant  
 • Fourth digit represents the number of zeros to follow.

Absolute Tolerance Code \_\_\_\_\_  
 • B = ±0.1%      • F = ±1%  
 • D = ±0.5%

Temperature Coefficient Code \_\_\_\_\_  
 • A = ±100ppm/°C    • C = ±25ppm/°C  
 • B = ±50ppm/°C

Ratio Tolerance (Optional) \_\_\_\_\_  
 • A = ±0.05% to R1    • D = ±0.5% to R1  
 • B = ±0.1% to R1

Consult factory for other available options.

### Package Power Temp. Derating Curve

(Low Profile, 4300T)

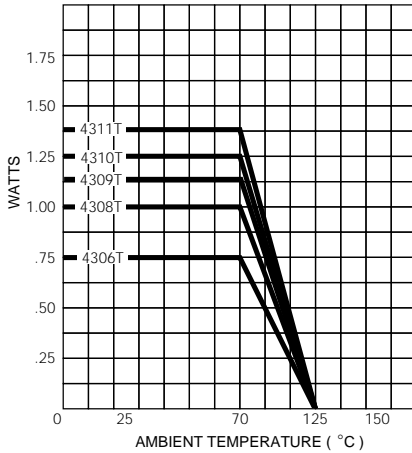

### Package Power Ratings at 70°C

	T	S	K
4304	0.60	0.80	1.00
4306	0.75	0.90	1.20
4308	1.00	1.20	1.60
4309	1.13	1.38	1.80
4310	1.25	1.50	2.00
4311	1.38	1.60	2.00

### Typical Part Marking

Represents total content. Layout may vary.

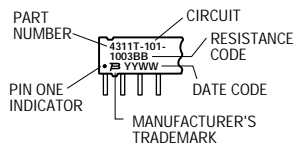

### Product Dimensions

4300T

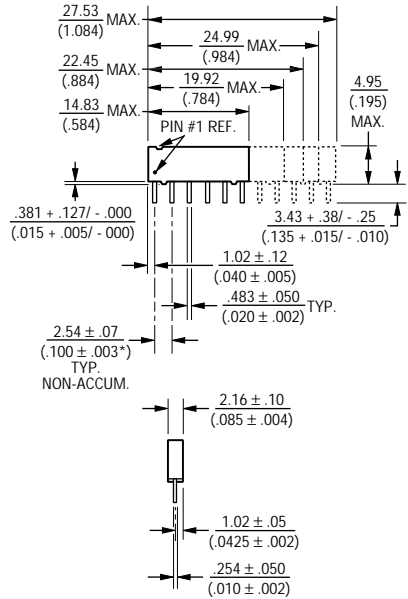

Governing dimensions are in metric. Dimensions in parentheses are inches and are approximate.

\*Terminal centerline to centerline measurements made at point of emergence of the lead from the body.

# 4300T, S, K Series - Thin Film Molded SIP



## Isolated Resistors (102 Circuit)

Available in 6, 8, 10 Pin

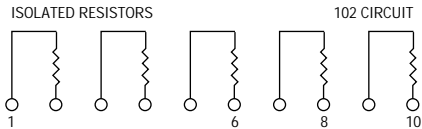

These models incorporate 3, 4, or 5 isolated thin-film resistors of equal value, each connected between a separate pin.

### Power Rating per Resistor

T .....	0.18 watt
S .....	0.20 watt
K .....	0.25 watt
Resistance Range...	20 to 200K ohms

## Bussed Resistors (101 Circuit)

Available in 6, 8, 9, 10, 11 Pin

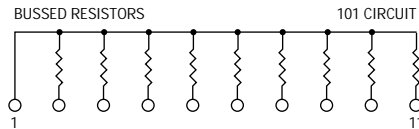

These models incorporate 5, 7, 8, 9, or 10 thin-film resistors of equal value, each connected between a separate pin.

### Power Rating per Resistor

T .....	0.10 watt
S .....	0.12 watt
K .....	0.15 watt
Resistance Range...	49.9 to 100K ohms

## Series Circuit (106 Circuit)

Available in 6, 8, 9, 10, 11 Pin

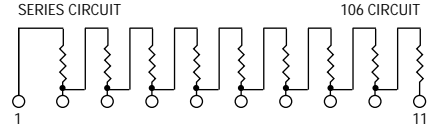

These models incorporate 5, 7, 8, 9, or 10 thin-film resistors of equal value, each connected in a series.

### Power Rating per Resistor

T .....	0.10 watt
S .....	0.12 watt
K .....	0.15 watt
Resistance Range .....	20 to 100K ohms

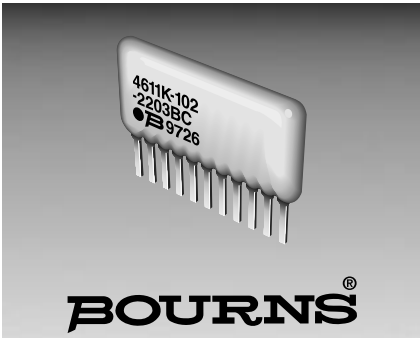

## Features

- Low profile provides compatibility with DIPs
- Also available in medium profile (4600S - .250") and high profile (4600K - .350")
- Marking on contrasting background
- Custom circuits available per factory

# 4600T, S, K Series - Thin Film Conformal SIP

### Product Characteristics

Resistance Range  
 Busse.....49.9 to 100K ohms  
 Isolated.....20 to 200K ohms  
 Series.....20 to 100K ohms

Resistance Tolerance  
 .....±0.1%, ±0.5%, ±1%

Temperature Coefficient  
 .....±100ppm/°C, ±50ppm/°C,  
 ±25ppm/°C

Temperature Range  
 .....-55°C to +125°C

Insulation Resistance  
 .....10,000 megohms minimum

TCR Tracking .....±5ppm/°C

### Environmental Characteristics

Thermal Shock and Power Conditioning .....0.1%  
 Short Time Overload ..... 0.1%  
 Terminal Strength ..... 0.25%  
 Resistance to Soldering Heat ..... 0.1%  
 Moisture Resistance ..... 0.1%  
 Life .....0.5%

### Physical Characteristics

Body Material Flammability  
 .....Conforms to UL94V-0

Body Material.....Epoxy resin

### HOW TO ORDER

**46 11 T - 101 - 2222 F A B**

Model \_\_\_\_\_  
 (46 = Conformal SIP)

Number of Pins \_\_\_\_\_

Physical Config. \_\_\_\_\_  
 • T = Low Profile Thin Film  
 • S = Medium Profile Thin Film  
 • K = High Profile Thin Film

Electrical Configuration \_\_\_\_\_  
 • 101 = Busse  
 • 102 = Isolated  
 • 106 = Series

Resistance Code \_\_\_\_\_  
 • First 3 digits are significant  
 • Fourth digit represents the number of zeros to follow.

Absolute Tolerance Code \_\_\_\_\_  
 • B = ±0.1%      • F = ±1%  
 • D = ±0.5%

Temperature Coefficient Code \_\_\_\_\_  
 • A = ±100ppm/°C    • C = ±25ppm/°C  
 • B = ±50ppm/°C

Ratio Tolerance (Optional) \_\_\_\_\_  
 • A = ±0.05% to R1    • D = ±0.5% to R1  
 • B = ±0.1% to R1

Consult factory for other available options.

### Package Power Temp. Derating Curve

(Low Profile, 4300T)

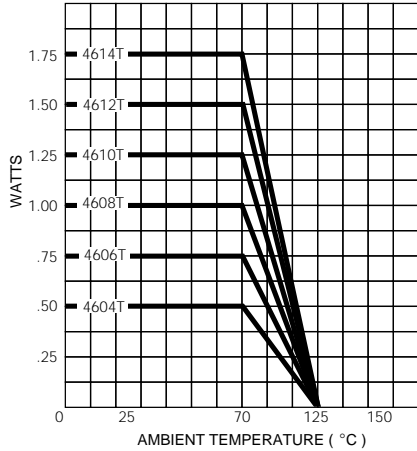

### Package Power Ratings at 70°C

	T	S	K
4604	0.50	0.60	0.8 watts
4605	0.63	0.75	1.0 watts
4606	0.75	0.90	1.2 watts
4607	0.88	1.05	1.4 watts
4608	1.00	1.20	1.6 watts
4609	1.13	1.35	1.8 watts
4610	1.25	1.50	2.0 watts
4611	1.38	1.65	2.2 watts
4612	1.50	1.80	2.4 watts
4613	1.63	1.95	2.6 watts
4614	1.75	2.10	2.8 watts

### TYPICAL PART MARKING

Represents total content. Layout may vary.

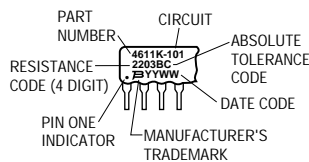

### Product Dimensions

4600T

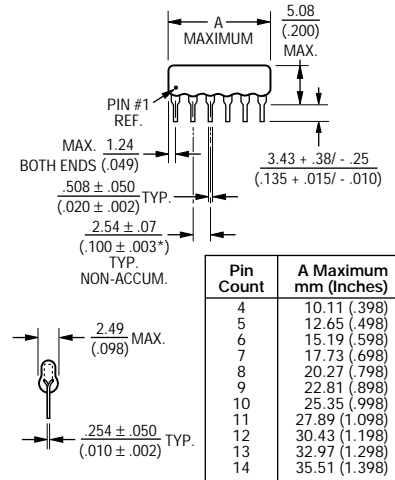

Maximum package length is equal to 2.54mm (.100") times the number of pins, less .005mm (.002").

Governing dimensions are in metric. Dimensions in parentheses are inches and are approximate.

\*Terminal centerline to centerline measurements made at point of emergence of the lead from the body.



# 4600T, S, K Series - Thin Film Conformal SIP



### Isolated Resistors (102 Circuit)

Available in 4, 6, 8, 10, 12, 14, 16 Pin

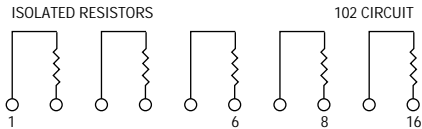

These models incorporate 2 to 8 isolated thin-film resistors of equal value, each connected between a separate pin.

### Power Rating per Resistor

T .....0.18 watt  
 S .....0.20 watt  
 K .....0.25 watt  
 Resistance Range... ..20 to 200K ohms

### Bussed Resistors (101 Circuit)

Available in 4 through 16 Pin

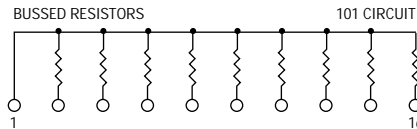

These models incorporate 3 to 15 thin-film resistors of equal value, each connected between a separate pin.

### Power Rating per Resistor

T .....0.10 watt  
 S .....0.12 watt  
 K .....0.15 watt  
 Resistance Range... ..49.9 to 100K ohms

### Series Circuit (106 Circuit)

Available in 4 through 16 Pin

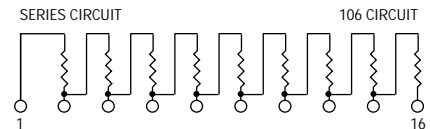

These models incorporate 3 to 15 thin-film resistors of equal value, each connected in a series.

### Power Rating per Resistor

T .....0.10 watt  
 S .....0.12 watt  
 K .....0.15 watt  
 Resistance Range.....20 to 100K ohms

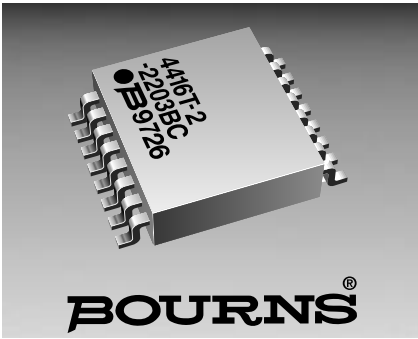

## Features

- Increased lead density
- Custom circuits available per factory

# 4400T - Thin Film Wide Body Gull Wing

### Product Characteristics

Resistance Range .....10 to 150K ohms  
 Resistance Tolerance  
 .....±0.1%, ±0.5%, ±1%  
 Temperature Coefficient  
 .....±100ppm/°C, ±50ppm/°C,  
 ±25ppm/°C  
 Temperature Range  
 .....-55°C to +125°C  
 Insulation Resistance  
 .....10,000 megohms minimum  
 TCR Tracking .....±5ppm/°C  
 Maximum Operating Voltage.....50V

### Environmental Characteristics

TESTS PER MIL-STD-202 .....ΔR MAX  
 Thermal Shock ..... 0.1%  
 Short Time Overload ..... 0.1%  
 Resistance to Soldering Heat ..... 0.1%  
 Moisture Resistance ..... 0.5%  
 Life ..... 0.5%

### Physical Characteristics

Lead Frame Material  
 .....Copper, solder coated  
 Body Material Flammability  
 .....Conforms to UL94V-0  
 Body Material .....Novolac Epoxy

### How To Order

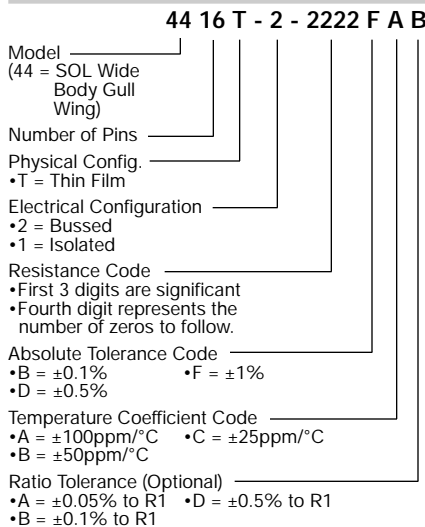

Consult factory for other available options.

### Package Power Temp. Derating Curve



### Package Power Ratings at 70°C

4416T .....1.60 watts  
 4420T .....2.00 watts

### Typical Part Marking

Represents total content. Layout may vary.

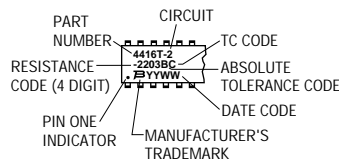

### Isolated Resistors (1 Circuit)

Available in 16 and 20 Pin

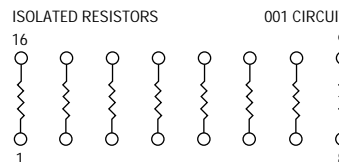

These models incorporate 8 or 10 thin-film resistors of equal value, each connected between a separate pin.

Power Rating per Resistor.....0.15 watt  
 Resistance Range .....10 to 150K ohms

### Product Dimensions

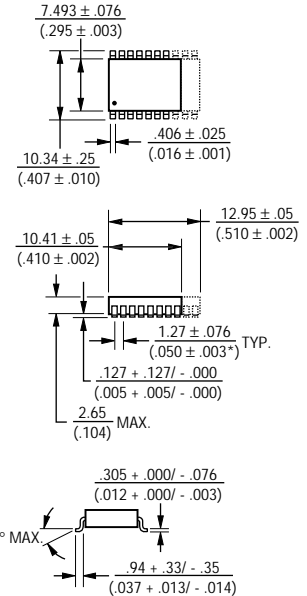

Governing dimensions are in metric. Dimensions in parentheses are inches and are approximate.

\*Terminal centerline to centerline measurements made at point of emergence of the lead from the body.

### Bussed Resistors (2 Circuit)

Available in 16 and 20 Pin

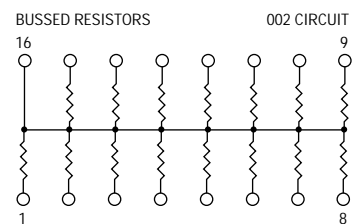

These models incorporate 15 or 19 thin-film resistors of equal value, each connected by a common pin.

Power Rating per Resistor.....0.10 watt  
 Resistance Range .....10 to 75K ohms

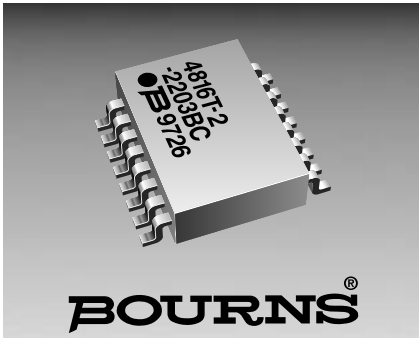

## Features

- Increased lead density
- Custom circuits available per factory

# 4800T - Thin Film Medium Body Gull Wing

### Product Characteristics

Resistance Range .....10 to 100K ohms  
 Resistance Tolerance  
 .....±0.1%, ±0.5%, ±1%  
 Temperature Coefficient  
 .....±100ppm/°C, ±50ppm/°C,  
 .....±25ppm/°C  
 TCR Tracking .....±5ppm/°C  
 Temperature Range  
 .....-55°C to +125°C

Maximum Operating Voltage.....50V

### Environmental Characteristics

TESTS PER MIL-STD-202 .....ΔR MAX  
 Thermal Shock .....0.1%  
 Short Time Overload .....0.1%  
 Resistance to Soldering Heat .....0.1%  
 Moisture Resistance .....0.1%  
 Life .....0.5%

### Physical Characteristics

Lead Frame Material  
 .....Copper, solder coated  
 Body Material Flammability  
 .....Conforms to UL94V-0  
 Body Material .....Novolac Epoxy

### How To Order

**48 16 T - 2 - 2222 F A B**

Model \_\_\_\_\_  
 (48 = SOM Medium Body Gull Wing)  
 Number of Pins \_\_\_\_\_  
 Physical Config. \_\_\_\_\_  
 • T = Thin Film  
 Electrical Configuration \_\_\_\_\_  
 • 2 = Bussed  
 • 1 = Isolated  
 Resistance Code \_\_\_\_\_  
 • First 3 digits are significant  
 • Fourth digit represents the number of zeros to follow.  
 Absolute Tolerance Code \_\_\_\_\_  
 • B = ±0.1%      • F = ±1%  
 • D = ±0.5%  
 Temperature Coefficient Code \_\_\_\_\_  
 • A = ±100ppm/°C      • C = ±25ppm/°C  
 • B = ±50ppm/°C  
 Ratio Tolerance (Optional) \_\_\_\_\_  
 • A = ±0.05% to R1      • D = ±0.5% to R1  
 • B = ±0.1% to R1

Consult factory for other available options.

### Package Power Temp. Derating Curve

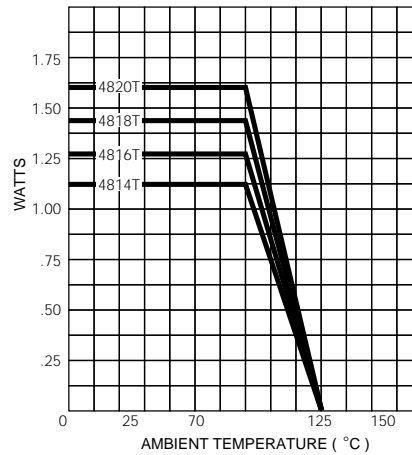

### Package Power Ratings at 70°C

4814T	.....1.12 watts
4816T	.....1.28 watts
4818T	.....1.44 watts
4820T	.....1.60 watts

### Typical Part Marking

Represents total content. Layout may vary.

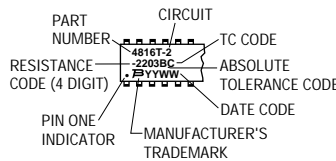

### Isolated Resistors (1 Circuit)

Available in 14, 16, 18, and 20 Pin

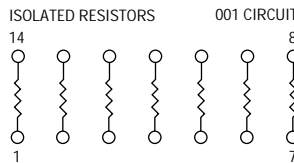

These models incorporate 7, 8, 9, or 10 thin-film resistors of equal value, each connected between a separate pin.

Power Rating per Resistor.....0.10 watt  
 Resistance Range .....10 to 100K ohms

### Product Dimensions

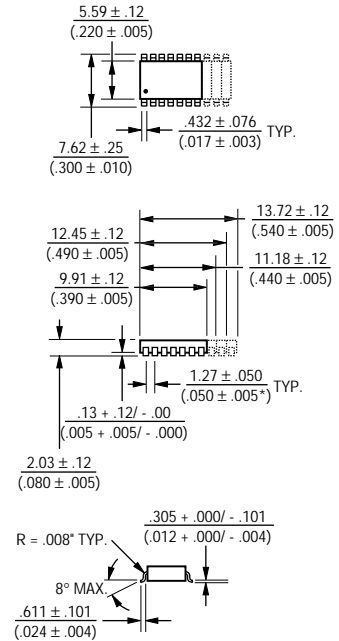

Governing dimensions are metric. Dimensions in parentheses are inches and are approximate.

### Bussed Resistors (2 Circuit)

Available in 14, 16, 18, and 20 Pin

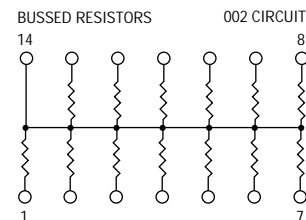

These models incorporate 13, 15, 17 or 19 thin-film resistors of equal value, each connected by a common pin.

Power Rating per Resistor.....0.08 watt  
 Resistance Range .....10 to 50K ohms

## General Description

Continual advances in digital IC technology are creating stringent demands on EMI/RFI levels in equipment.

EMI/RFI low pass filters are required in personal computers, data terminals, test equipment and process controllers for high frequency suppression into or out of electronic equipment.

## Filter Selection and Design Considerations

The “roll-off” frequency  $f_c$ , defined as the frequency at which the filter passes one-half the power it receives at its input terminal, can be specified from the low megahertz range up to about 100MHz. This frequency, also known as the “-3 dB” frequency, will be determined by the R and C values chosen. Custom resistor and capacitor values are available to optimize system performance.

The specification of these values will depend on constraints relating to noise frequencies, system performance and driver loading. The following procedure is suggested to choose appropriate values of R and C.

The first step is to determine the desired roll-off frequency of the filter, which will lie between the signal frequency and the dominant frequencies of the EMI/RFI noise. By determining the pole of the filter (setting the denominator of the transfer function equal to zero), the roll-off frequency can be expressed in terms of R and C:

$$f_c = \frac{R_S + R_L + 2R}{2\pi C(R + R_S)(R + R_L)}$$

Furthermore, the RC combination must be chosen so that the additional RC time delay will not result in exceeding the sampling window of the receiving IC, due to excessive lengthening of signal rise and fall times.

Rise time from 10% to 90% of the waveform amplitude can be calculated in terms of the circuit's RC time constant using the  $1 - \exp(-t/RC)$  relationship for a charging capacitor. At 10%,  $t_L = 0.1$  time constants, and at 90%,  $t_H = 2.3$  time constants. “Time constant” equals  $R_{th}C$ , where  $R_{th}$  is the Thevenin-equivalent resistance as seen by the capacitor.

Therefore, equating the difference in the two times to the maximum tolerable rise (or fall) time:

$$t_{max} = t_H - t_L = 2.2R_{th}C$$

$$t_{max} = 2.2 \frac{(R + R_S)(R + R_L)C}{R_S + R_L + 2R}$$

A final consideration is the insertion loss. As mentioned previously, the voltage drop across the two resistors will attenuate the voltage reaching the load. Normally, logic high and low levels will still be within valid limits. The signal attenuation can be minimized by choosing small R values relative to the load impedance. Typical values for R range from 10 to 50 ohms.

## Bourns Low-pass Filters for EMI/RFI Suppression

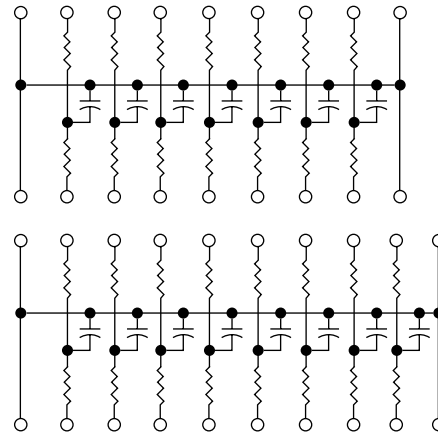

NO. OF LINES	BOURNS P/N	PACKAGE
7	4118R-601-RC/CC	DIP
8	4120R-601-RC/CC	
8	4420P-601-RC/CC	Wide Body SMD

## Standard Resistance/Capacitance Values And Codes

RC	R	CC	C
250	25Ω	500	50pF
270	27Ω	101	100pF
470	47Ω	181	180pF
820	82Ω	201	200pF
101	100Ω		

## Reducing EMI/RFI

The radiation of electromagnetic interference and radio frequency interference (EMI/RFI) to the environment is a pressing concern for many manufacturers of electronic equipment. According to FCC regulations (Parts 15 and 18), emissions must not exceed certain maximum levels depending on whether the equipment is for strictly industrial use or also for residential use. A graphical representation of these limits is shown in Figure 1. Similar restrictions apply to equipment sold in Europe (VDE 0871, a West German standard), Japan (VCCI), and to the military (MIL-STD-461/462.)

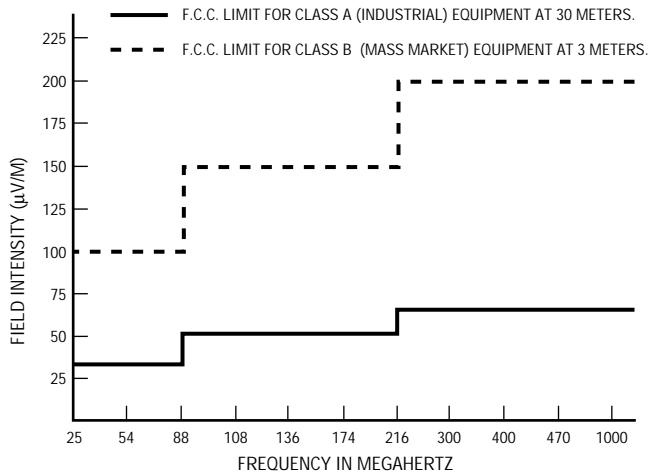

**Figure 1.**  
F.C.C. radiation limits for class A and class B computing devices

Several approaches are available today to control EMI/RFI emissions, including grounded metal enclosures, shielded cables, judicious component placement and interconnect designs, power-supply decoupling, and low-pass filtering of signal lines.

Low-pass filtering can be effective for EMI/RFI filtering when the noise components to be rejected occur at frequencies higher than the signal frequency (to be passed). For these situations, Bourns has developed low-pass resistor-capacitor filter networks which are ideal for board-level EMI/RFI filtering.

A typical application would be to filter signal lines between RS-232 drivers and their corresponding connectors. In such low to medium frequency applications, these networks represent a more useful (and economical) solution than inductive type filters such as ferrite beads. In fact, ferrite beads become mostly ineffective below 10MHz.

The basic "T" configuration (Figure 2) is a standard R-C network available in versions for 7 or 8 input lines. The 8 input-line version is available in both through-hole DIP and surface-mount models.

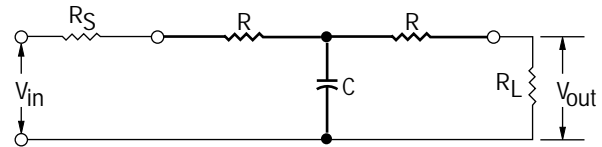

**Figure 2.**  
basic T-Filter configuration

Under steady state conditions, the capacitor C offers an infinite impedance to the DC component of the input waveform (which will be assumed for the moment to be entering from the left side). Thus, the DC component of the signal voltage is passed to the load, but reduced in value by the voltage drop across the two resistors.

The impedance of C becomes lower at higher (noise) frequencies. Thus, the noise component of the signal faces a voltage divider consisting of the first resistor (R) and C. At the high frequencies of the noise component, R will be much greater than the impedance of C, therefore, most of the noise voltage will be dropped across the resistor. Almost no noise current flows through the load and, therefore, will hardly affect the DC voltages (i.e., the signal) across the load.

Since the filter is symmetric, its principle of operation is the same for waveforms traveling in the opposite direction, in which case the voltage divider is formed by the second resistor and the capacitor. Such a symmetrical design is useful for filtering signals on a bidirectional bus.

Assuming purely resistive source and load impedances, the transfer function is given by:

$$\frac{V_{out}}{V_{in}} = \frac{R_L}{j\omega C(R + R_S)(R + R_L) + (R_S + R_L + 2R)}$$

# RC Terminator Networks 700 Series



## General Description

This series of RC Networks is designed to eliminate transmission line effects, such as signal reflections and ringing which influence high speed CMOS. The Networks capacitor blocks DC currents while acting as a short circuit during signal transmissions, thus reducing power consumption. The capacitor also holds the bus at the last logic level to avoid excessive currents.

## Block Diagram Of CPU/BUS Configuration

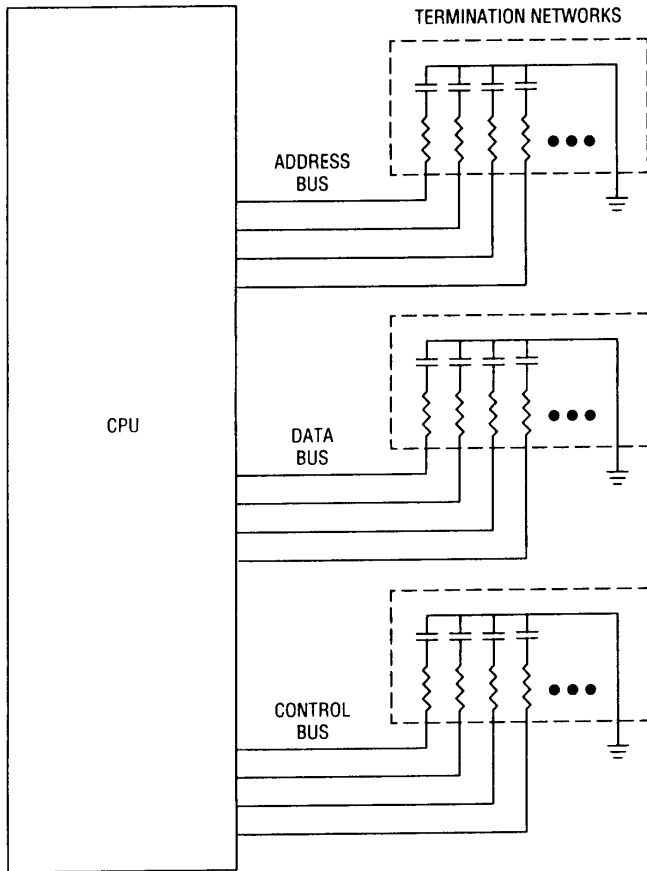

## Bus Termination Applications Of Bourns Networks

At high frequencies, the traces on a printed circuit board act as transmission lines—in which impedance mismatches can cause distortion of signals on that line. Terminating the lines with resistor or resistor-capacitor networks provides the means to match impedances and reduce signal distortion.

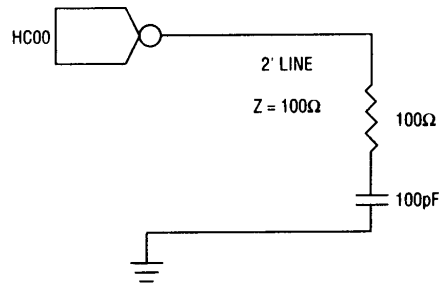
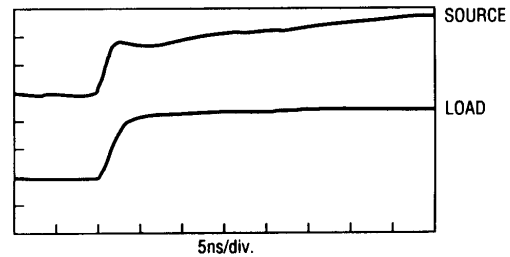

Bus termination (in this case, RC termination technique) considerably reduces overshoots and ringings.

Transmission lines require termination when the time it takes the signal to travel from one end of the line to the other (the propagation delay) amounts to 1/2 or more of the edge rate of the signal (signal rise time or fall time). In other words, termination is required when:

$$T_{pd} > (1/2)T_e \quad \begin{matrix} T_e = \text{edge rate} \\ T_{pd} = \text{propagation delay} \end{matrix}$$

Present high-speed logic families have typical rise times of 2 nanoseconds, while the propagation delay of a common PCB is about 1.77 ns per foot. Applying the above relationship, a transmission line will require termination if it is longer than 7 inches.

High performance systems will commonly need Bourns termination networks for CPU address, data, and control lines. In addition, clock inputs, write and read strobe lines, chip select or output enable lines of high speed devices such as static RAMs, PROMs, and PLDs will also need termination networks.

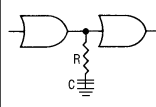
TERMINATION TECHNIQUE	TYPICAL POWER USAGE	ADDS DELAY	RESISTOR VALUE	CAPACITOR VALUE
RC 	MEDIUM	NO	$Z_0$	200-500pF

# RC Terminator Networks 700 Series

**BOURNS®**

For designers developing high performance systems, exact termination resistances which account for line loading may be desirable. This resistance (or equivalent resistance) can be calculated using the formula:

$$R_{\text{term}} = \frac{Z_0}{\sqrt{1 + C_d / C_0}}$$

where  $Z_0$  is the characteristic impedance of the line,  $C_d$  is the total capacitance associated with the receiving devices (typically 5 pF per input gate) or other loads off the line, and  $C_0$  is the intrinsic capacitance of the line.

The series termination technique suppresses reflections at the driving device should any waveforms be reflected back from the driven end of the line. Series termination preserves power since there is no current path to ground or Vcc as in the other methods. However, this technique results in incident signals that transition slowly. It is also not appropriate for distributed loads due to the half-amplitude waveforms which exist at intermediate points along the line.

RC termination represents a compromise between power consumption and effect on performance. Its principle of operation is similar to parallel termination, but the capacitor blocks the DC component of the signal, thus reducing power consumption. However, the effectiveness of this method depends on the frequency and duty cycle of the application. RC termination also can be an expensive technique if implemented using discrete components rather than a network.

### Typical Usage

While not every address, data and control line may require pull-up/pull-down or termination as part of the system's design, the table below shows common practice for some popular devices.

	MICROPROCESSORS				MICRO-CONTROLLERS	
	68000	68020	80286	80386	68HC11	8051
No. address lines	23	32	24	32		
Termination	0	32	0	32		
No. data lines	16	32	16	32		
Termination	0	32	0	32		
No. control lines	21	27	13	15		
Termination	0	27	0	15		
Total I/O lines	60	91	53	79	38	32
Termination	0	91	0	79	0	0

**701**

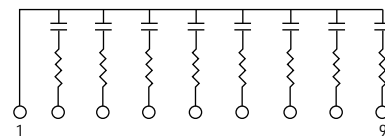
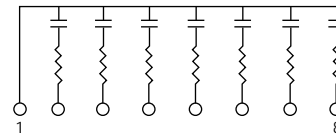

NO. OF LINES	BOURNS P/N	PACKAGE
7	4608H-701-RC/CC	High Profile Conformal SIP
8	4609H-701-RC/CC	
9	4610H-701-RC/CC	

**702**

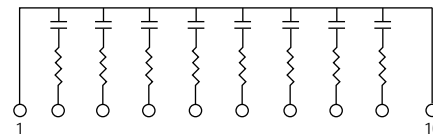

NO. OF LINES	BOURNS P/N	PACKAGE
8	4610H-702-RC/CC	High Profile Conformal SIP

For all RC terminators, standard R values are 50, 68, 75 and 100 ohms. Standard values for C are 47, 100, 500 and 1000pF. See data sheet to select custom combinations of R and C.

### REFERENCES:

1. Blood, W.R., MECL System Design Handbook, Motorola, Inc., 1983.
2. F100K ECL Data Book, Fairchild Semiconductor Corp., 1986.
3. MECL Device Data, Motorola, Inc., 1987.

# Bourns Emitter Coupled Logic Terminator 800 Series **BOURNS**<sup>®</sup>

## Typical Application

A typical application using a Bourns 801 RC Network in conjunction with a 10K ECL design is shown below. V<sub>ee</sub> is typically connected to -5.2 volts (10K ECL) or -4.5 volts (100K ECL). V<sub>CC</sub> is typically connected to GND. V<sub>tt</sub> is typically connected to -2.0 volts. The 801 network shown below can terminate up to 6 transmission lines and provides a 0.01 μF capacitor to reduce cross talk and feedthrough effects.

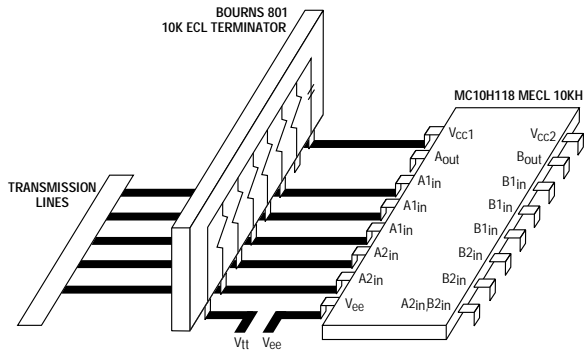

## Transmission Line Considerations

In high speed circuit applications, the signal propagation delay ( $T_{pd}$ ) and characteristic impedance ( $Z_0$ ), along a printed circuit board line must be taken into consideration. In general, if the two-way delay along the line is greater than the rise or fall time of the signal, then controlled impedance techniques (i.e., termination) must be utilized to prevent undesirable ringing or over- and undershoots. The delay and impedance can be calculated by knowing the intrinsic inductance ( $L_0$ ) and capacitance ( $C_0$ ) of the line:

$$T_{pd} = \sqrt{L_0 C_0}$$

$$Z_0 = \sqrt{L_0 / C_0}$$

The actual, effective delay and impedance due to loading from stubs or additional devices off the line will be:

$$T_{pd}' = T_{pd} \sqrt{1 + C_d / C_0}$$

$$Z_0' = \frac{Z_0}{\sqrt{1 + (C_d / C_0)}}$$

Where  $C_0$  = intrinsic capacitance of the line  
 $C_d$  = capacitance due to loading and stubs off the line  
 $T_{pd}$  = basic propagation delay of the line  
 $Z_0$  .... = basic impedance of the line

To formulate a guideline for when line termination is necessary, take the ratio of the rise time or fall time and the two-way delay along the line. The maximum length for unterminated lines will result as follows:

$$L_{max} = \frac{T_r}{2T_{pd}}$$

Where  $T_r$  = rise or fall time  
 $T_{pd}$  = propagation delay per unit length

The above equation implies that the faster the edge rate or the higher the loading on the line (i.e., higher fanout), the more likely that termination will be necessary for a given line length.

## Parallel Termination

For maximum circuit performance or distributed loads, parallel termination is the most appropriate technique. A parallel terminated line uses a resistor connected to -2 volts (ECL application) at the receiving end. The resistor value matches the characteristic impedance of the line ( $Z_0$ ), thereby producing zero reflection at the receiver. In addition, the terminating resistor also provides output pull down, so a separate pull down resistor at the driving end is unnecessary.



## Bourns Emitter Coupled Logic Terminator 800 Series **BOURNS®**

Bourns 801, 802, and 804 conformal coated SIP resistor capacitor networks are designed to terminate 6 transmission lines using the parallel termination technique. A 0.01  $\mu\text{F}$  capacitor(s) is provided in each network to help maintain a solid  $V_{\text{tt}}$  level within the package, mitigating any potential cross talk or feedthrough effects. The 804 circuit also contains a 0.1  $\mu\text{F}$  capacitor for bypassing the  $V_{\text{ee}}$  supply.

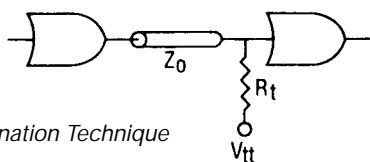

Parallel Termination Technique

### Thevenin Equivalent Parallel Termination

Parallel termination in ECL applications uses -2.0 volts as the terminating voltage. This represents a disadvantage since a separate  $V_{\text{tt}}$  power supply must be available ( $V_{\text{ee}} = -5.2$  volts,  $V_{\text{tt}} = -2.0$  volts). For systems in which a separate -2.0 volt supply is not available, the use of a Thevenin equivalent arrangement, although resulting in higher power consumption, provides a convenient solution.

Bourns 803 and 805 conformal coated SIP resistor capacitor networks are designed to terminate 8 transmission lines using the Thevenin equivalent parallel termination technique. Again, a 0.1  $\mu\text{F}$  capacitor is provided to help maintain a solid  $V_{\text{ee}}$  level within the package, mitigating any potential cross talk or feedthrough effects. The 803 is designed for use with 10K ECL whereas the 805 is designed for use with 100K ECL.

$R_1$  and  $R_2$  are calculated using the following equations:

$$R_2 = (V_{\text{ee}}/V_{\text{tt}}) * Z_0$$

$$R_1 = (R_2 * V_{\text{tt}}) / (V_{\text{ee}} - V_{\text{tt}})$$

For a 10K ECL supply voltage of -5.2V and  $V_{\text{tt}}$  of -2V:

$$R_2 = 2.6 * Z_0$$

$$R_1 = R_2 / 1.6$$

For a 100K ECL supply voltage of -4.5V and  $V_{\text{tt}}$  of -2V:

$$R_2 = 2.25 * Z_0$$

$$R_1 = R_2 / 1.25$$

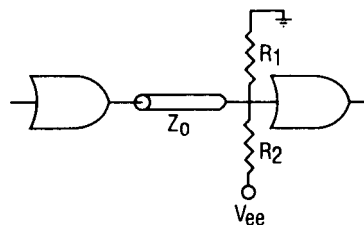

Thevenin Equivalent Parallel Termination Technique

### References:

1. Blood, W.R., MECL System Design Handbook, Motorola, Inc., 1983.
2. F100K ECL Data Book, Fairchild Semiconductor Corp., 1986.
3. MECL Device Data, Motorola, Inc., 1987.
4. ECLinPS Data, Motorola, Inc., 1987.

# Dual Terminator Resistor Network



The Dual Terminator (or Thevenin equivalent) Network is commonly used for TTL dual-line termination and pulse squaring or ECL line terminations. In ECL line terminator, R2 functions as an emitter pull-down resistor and is normally tied to the most negative supply voltage to provide proper line currents. R1 is normally tied to ground and functions as the termination resistor and in parallel with R2 provides the characteristic impedance of the transmission line. This results in a zero reflection coefficient of this line to eliminate reflections.

The Dual Terminator circuit is available in both SIP and DIP configurations, as shown below.

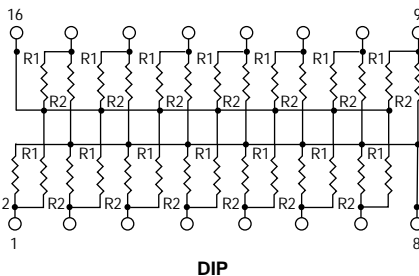
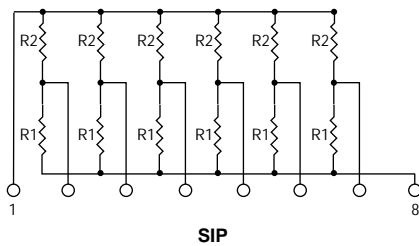

## Testing of Dual Terminators

Since the Dual Terminator circuit has many resistors in parallel, a direct pin-to-pin measurement for the values of R1 and R2 can be made using an ohmmeter with guard capabilities.

The function of the guard pin is to apply and equal voltage across the adjacent (parallel) resistance path. When applied, current flow is eliminated allowing an accurate measurement of the resistor under test.

Using the 8-pin SIP network shown, the testing method would be as follows:

### Test R1 Values

To test the first resistor, connect the ohmmeter measurement leads between pin 8 and pin 2. Connect the guard lead to pin 1.

R1 is now guarded and an accurate measurement can be made.

To test the second R1 resistor, connect the measurement leads between pin 8 and pin 3. Connect the guard to pin 1 and make the resistance measurement.

Continue this testing scheme for the remainder of the R1 resistors, always guarding pin 1.

### Test R2 Values

To test the first R2 resistor, connect the ohmmeter measurement leads between pin 1 and pin 2. Connect the guard lead to pin 8. The first R2 resistor is now guarded and an accurate measurement can be made.

To test the second R2 resistor, connect the ohmmeter measurement leads between pin 1 and pin 3. Connect the guard lead to pin 8 and make the resistance measurement.

Continue this testing scheme for the remainder of the R2 resistors, always guarding pin 8.

An example of the type of ohmmeter to be utilized that incorporates a guarded measurement capability. It must be noted that guarded measurements using ohmmeters are satisfactory measurements up to a ratio of about 10:1 between R1 and R2. Above a 10:1 ratio, accuracy is degraded and measurements can be incorrect because of inadequate guarding capability of the equipment.

### Unguarded Resistance Measurements

In the case where no guarded ohmmeter is available, the individual resistors can be evaluated by comparing the unguarded resistance measurement to the theoretical value of the equivalent series-parallel circuit and determining the percent of error of each resistor.

### Example:

Network 4608X-104-221/331 where R1 values are 220Ω and R2 values are 330Ω.

R<sub>p</sub> = Parallel Resistance of Remaining Circuit (See diagram below.)

R<sub>E</sub> = Equivalent Series - Parallel Resistance Seen by Unguarded Meter

$$R_{E_{R1}} = (P8-P2) = \frac{R1 (R2 + R_p)}{R1 + (R2 + R_p)} = \frac{220 (330 + 110)}{220 + (330 + 110)} = 146.67\Omega \quad 2\% \text{ Tolerance} \approx \pm 1.96\Omega^*$$

$$R_{E_{R2}} = (P1-P2) = \frac{R1 (R2 + R_p)}{R1 + (R2 + R_p)} = \frac{3300 (220 + 110)}{330 + (220 + 110)} = 165\Omega \quad 2\% \text{ Tolerance} \approx \pm 1.65\Omega^*$$

$$R_p = \frac{550}{5} = 110\Omega$$

Utilization of these formulas will enable you to determine the equivalent unguarded resistance to be expected from any values of R1 and R2 for a Dual Terminator Network.

$$*2\% \text{ tolerance} \approx \frac{(R_{E_{R1}})^2}{R1} \times .02 = 1.96\Omega$$

# SCSI Applications

**BOURNS®**

AMERICAN NATIONAL STANDARD X3 131-1986

Peripheral devices such as magnetic-disks, printers, optical-disks, and magnetic-tapes.

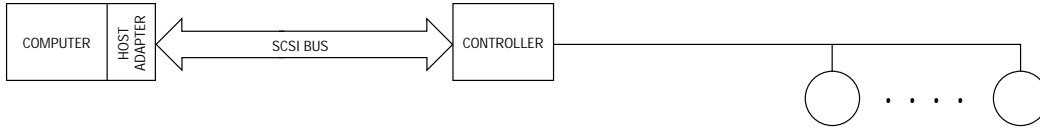

**SINGLE INITIATOR, SINGLE TARGET**

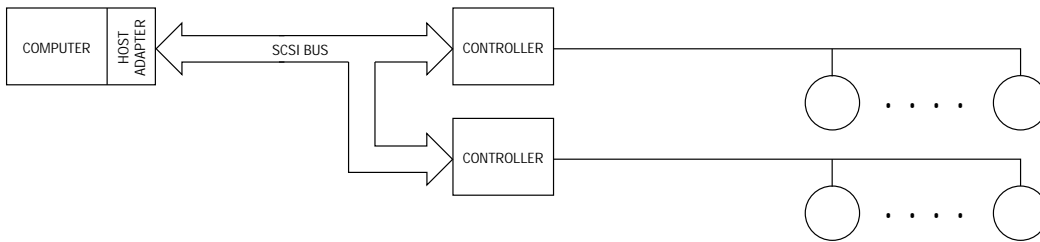

**SINGLE INITIATOR, MULTIPLE TARGET**

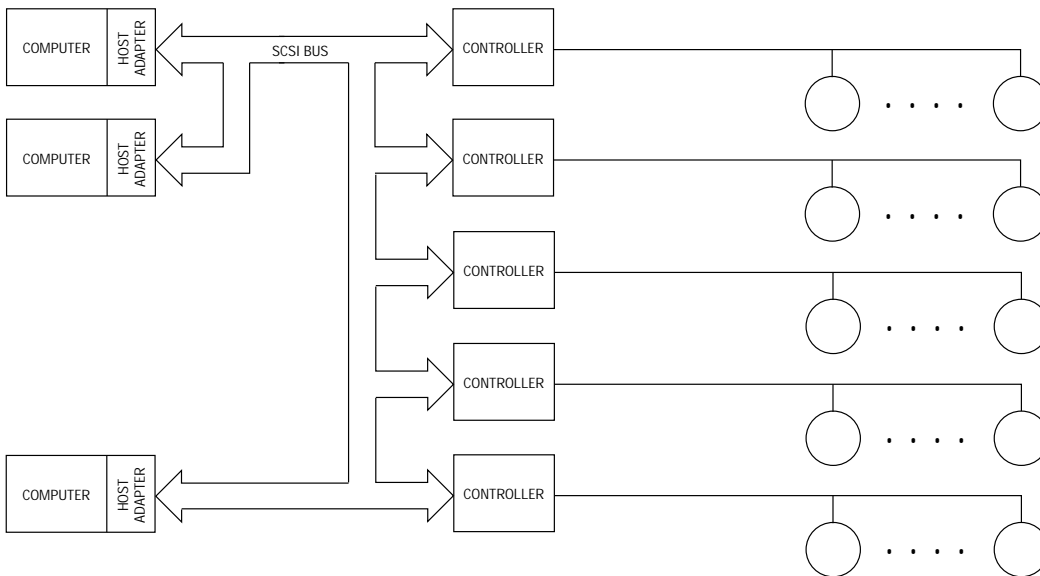

**MULTIPLE INITIATOR, MULTIPLE TARGET**

**BLOCK DIAGRAM OF SCSI SYSTEM**

**Use Bourns Networks to:**

- Provide the terminating resistors required for SCSI implementation.
- Optimize signal transmission by eliminating overshoot and ringing.
- Minimize space and routing problems, and reduce manufacturing cost per installed resistive function.
- Increase board yields and reliability by reducing component count.

**Termination Of The SCSI Bus**

The Small Computer System Interface follows American National Standard which provides the mechanical, electrical, and functional requirements for an input/output bus to connect small computers with a variety of peripheral devices. The most common application of this bus is to connect small computers with disk drive (mass storage) units.

The primary resistor network application in SCSI busses is line termination. The termination method is specified in ANSI X3.131-1986 as either a Thevenin equivalent dual terminator

configuration (Fig. 1) for the single-ended implementation of the SCSI bus, or a three-resistor terminator configuration (Fig. 2) for the differential-line version of the SCSI bus.

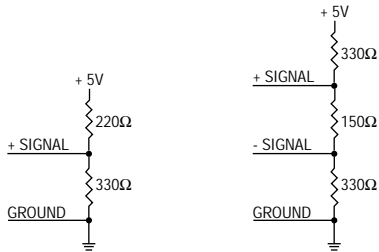

FIGURE 1.

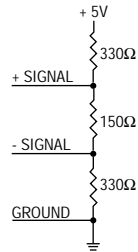

FIGURE 2.

In the single-ended configuration, the SCSI bus is defined for lengths up to 6 meters, while the differential-line version provides for better commonmode noise immunity over cable lengths up to 25 meters.

The signal assignments on the single-ended SCSI bus include 8 data lines, 1 parity line, and 9 control lines. Each of these 18 lines must be terminated, and it is convenient to do this using a resistor network which contains all of the required resistors. An additional 32 lines are ground or power lines which do not require termination (there are 50 lines total in the cable). In a similar fashion, the differential configuration of the SCSI bus uses 18 pairs of lines, each requiring termination.

As of 1989, an extended version of the SCSI standard has been in development by ANSI, called the SCSI-2 bus. This new standard allows for 16-bit to 32-bit wide data transfers, while also allowing a higher bit transfer rate.

Two cables are defined in the SCSI-2 bus, termed Cable A and Cable B, where Cable B is optional ("wide SCSI" option). Cable A is no different than the single cable used in the original SCSI bus, and therefore uses the same number and types of resistive terminators (i.e., dual terminators for single-ended and triple terminators for differential).

Cable B, however, is a 68-line cable, of which 29 lines (single-ended) or 29 line-pairs (differential) require termination.

### Application Guidelines

The principles of transmission-line theory apply to SCSI terminators, and therefore for proper operation their placement must be restricted to the ends of the bus and nowhere else. This implies that the terminators should be placed as close to the SCSI devices as possible. It is permissible to place the terminator inside the SCSI device, but only if that device is located at the end of the bus.

For disk drive applications, SCSI terminators must be present on the host adapter card and at the disk drive end as well. Many disk drive manufacturers have opted to design in removable SCSI terminators into their units to account for the possibility that their unit may not be the one at the end of the cable. For these manufacturers, the combination of a resistor network in a through-hole version plus a matching socket represents the only (and expensive) alternative.

A final consideration is the cable itself. Since the terminators are comprised of 220 ohm and 330 ohm resistors (single-ended), the cable ideally should have a characteristic impedance which

matches the Thevenin equivalent of this resistor combination, that is, 132 ohms. In the differential case, a characteristic impedance of 122 ohms would be ideal.

In addition, it is inadvisable to mix different, unmatched cables in the same bus. Such a practice will result in undesirable signal reflections which may compromise the integrity of the data transfer.

Bourns supplies a number of resistor network models designed for both SCSI and SCSI-2 termination.

### Cable A (SCSI and SCSI-2) Single-ended

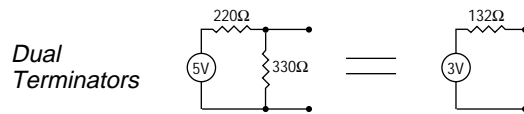

PACKAGE	NO. REQ'D.	BOURNS P/N
DIP	1	4120R-3-221/331
CSIP*	2	4611X-104-221/331
CSIP*	3	4608X-104-221/331
MSIP*	3	4308R-104-221/331

### Differential:

PACKAGE	NO. REQ'D.	BOURNS P/N
DIP	2	4120R-820-1
DIP	3	4120R-820-2
CSIP*	3	4116R-8-2
CSIP*	3	4614M-8-2
MSIP	5	4310M-820-2
		4120P-830-2
		4420P-820-1
		4420P-820-2
		4420P-830-2

### Cable B (SCSI-2 Only) Single-ended

PACKAGE	NO. REQ'D.	BOURNS P/N
DIP	2	4118R-3-221/331
CSIP*	3	4612X-104-221/331
CSIP*	4	4610X-104-221/331
MSIP*	4	4310R-104-221/331

### Differential:

PACKAGE	NO. REQ'D.	BOURNS P/N
DIP	4	4118R-820-2
DIP	5	4116R-8-2
CSIP*	5	4614M-820-2
MSIP*	8	4310M-820-2

\*MEDIUM PROFILE (.250" SEATED HEIGHT) AND HIGH PROFILE (.350" SEATED HEIGHT) ARE AVAILABLE BY PLACING THE LETTER "M" OR "H," RESPECTIVELY, IN THE FIFTH POSITION OF THE PART NUMBER.

# SCSI Applications Representative Terminator Schematics



## Representative Terminator Schematics

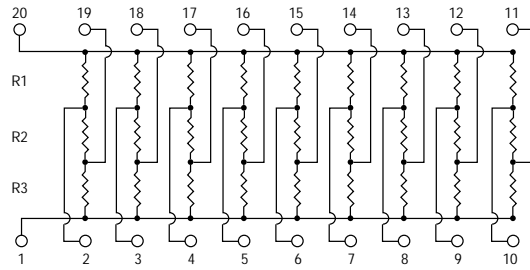
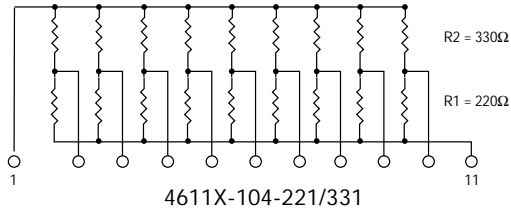

### 830 ELECTRICAL SCHEMATIC

4120R-830-1	4120R-830-2
4420P-830-1	4420P-830-2
R1 = 270Ω	R1 = 330Ω
R2 = 820Ω	R2 = 150Ω
R3 = 180Ω	R3 = 330Ω

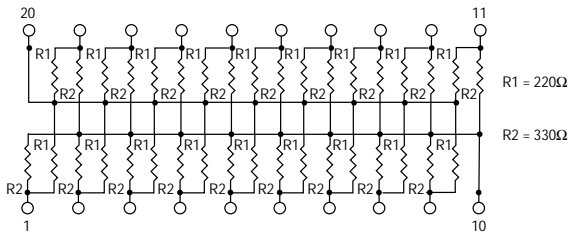

### Abbreviations

- DIP = Dual In-Line Package
- MSIP = Molded Single In-Line Package
- CSIP = Conformal Coated Single In-Line Package
- PCC = Plastic Chip Carrier
- SOM = Small Outline Surface Mount Package, Medium Body (.220")
- SOL = Small Outline Surface Mount Package, Wide Body (.300")
- SON = Small Outline Surface Mount Package, Narrow Body (.154")

### References

1. "Small Computer System Interface", (ANSI X3.131-1986), American National Standards Institute Inc., 1986.
2. "Small Computer System Interface 2" (working draft proposal), Revision 5, American National Standards Institute Inc., August 9, 1988.
3. Standard Products Data Book, NCR Corporation, 1988.

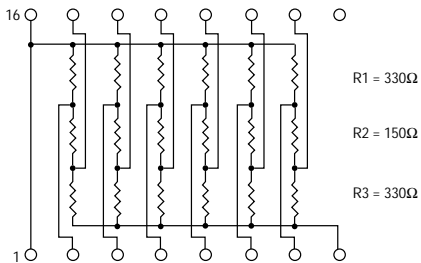

\*MEDIUM PROFILE (.250" SEATED HEIGHT) AND HIGH PROFILE (.350" SEATED HEIGHT) ARE AVAILABLE BY PLACING THE LETTER "M" OR "H," RESPECTIVELY, IN THE FIFTH POSITION OF THE PART NUMBER.

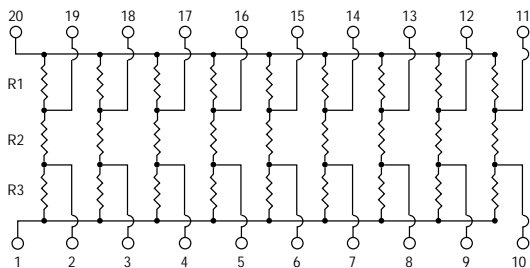

### 820 ELECTRICAL SCHEMATIC

4120R-820-1	4120R-820-2
4420P-820-1	4420P-820-2
R1 = 270Ω	R1 = 330Ω
R2 = 820Ω	R2 = 150Ω
R3 = 180Ω	R3 = 330Ω

# R/2R Ladder Networks



R/2R Ladder Networks are available in both DIP and SIP (Molded or Conformal) configurations.

taken from the R/2R ladder. This terminal (OUT) is commonly used to drive an operational amplifier.  $R_T$  (the terminating resistor) is always connected to ground.

Standard R/2R Ladder Networks have a resistance tolerance of  $\pm 2.0\%$  ( $\pm 1.0\%$  available on all but low profile SIPs).

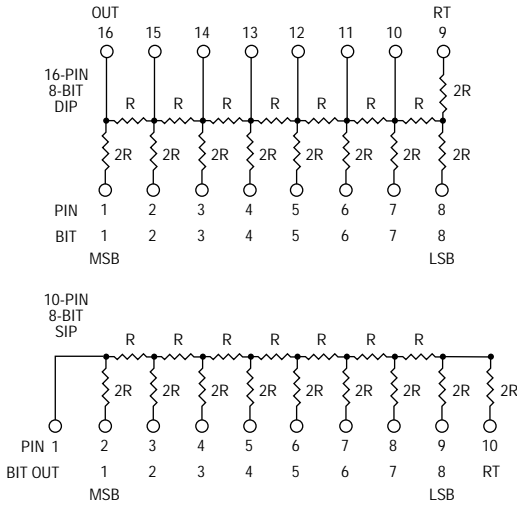

### Standard R/2R Ladder Networks

Availability is as follows:

DIP/SMD	SIP-CONFORMAL	SIP MOLDED
14 Pin - 7 Bit	6 Pin - 4 Bit	6 Pin - 4 Bit
16 Pin - 8 Bit	7 Pin - 5 Bit	8 Pin - 6 Bit
	8 Pin - 6 Bit	10 Pin - 8 Bit
	9 Pin - 7 Bit	
	10 Pin - 8 Bit	
	11 Pin - 9 Bit	
	12 Pin - 10 Bit	
	14 Pin - 12 Bit	

### Resistor Power Ratings @ 70° C

Low Profile SIP & DIP	.125W
Medium Profile SIP	.170W
High Profile SIP	.200W

The R/2R Ladder Network is commonly used for Digital to Analog (D/A) conversions and Analog to Digital (A/D) conversion by successive approximations. The bits of the ladder are the points at which input signals are presented to the ladder and the output terminal (OUT) is the point at which the output is

### How To Order R/2R Ladder Networks

41 16 R - R2R - 503

Model \_\_\_\_\_  
 (41 = Molded DIP)  
 (43 = Molded SIP)  
 (44 = Wide Body SMD)  
 (46 = Conformal SIP)  
 (48 = SMD)

Number of Pins \_\_\_\_\_

Physical Configuration \_\_\_\_\_  
 (R = Low Profile - Molded)  
 (X = Low Profile - Conformal)  
 (M = Medium Profile)  
 (H = High Profile)  
 (P = Medium Body SOIC)

Resistance/Capacitance Code  
 (For value of R). 2R is double this value.  
 • First 2 digits are significant.  
 • Third digit represents the number of zeros to follow.

Electrical Configuration \_\_\_\_\_  
 • R2R = R/2R Ladder Network

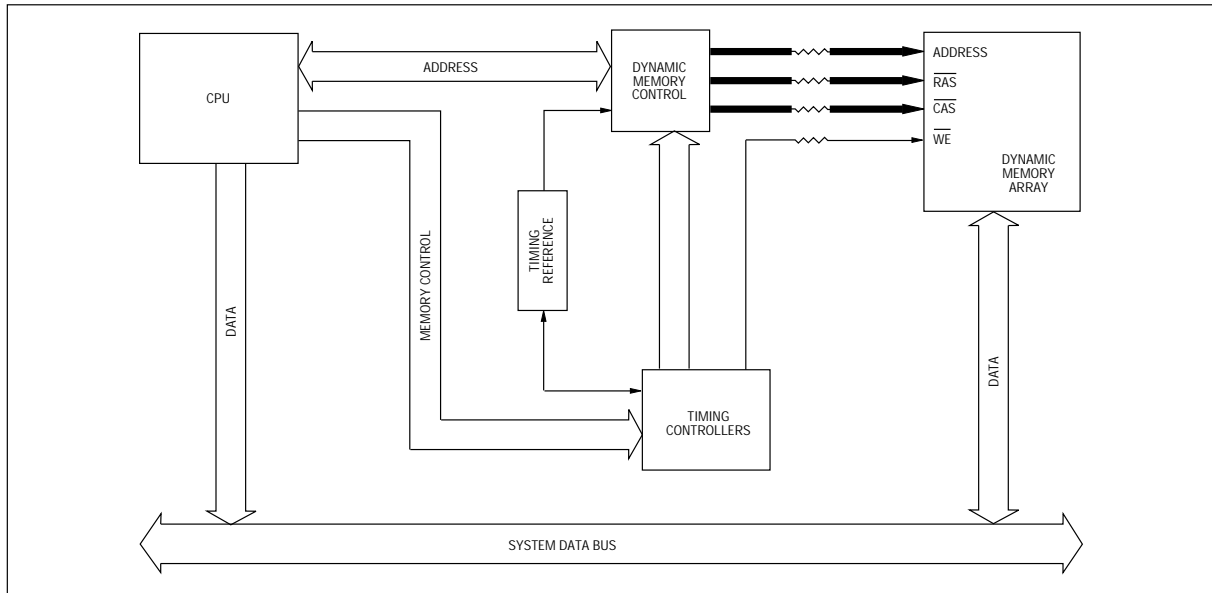

BLOCK DIAGRAM OF DRAM SYSTEM

### Use Bourns Networks To:

- Match impedance between memory driver and the DRAM array.
- Minimize reflections and ringing in DRAM inputs.
- Prevent undershoot of  $\overline{RAS}$ ,  $\overline{CAS}$ , and  $\overline{WE}$  signals which may result in latch-up of DRAM inputs
- Improve system performance by allowing faster settling times for DRAM inputs.

### Need For Damping

The address lines ( $\overline{RAS}$ ,  $\overline{CAS}$ ) and control lines ( $\overline{WE}$ ) of dynamic RAM arrays are driven in parallel, causing significant loading on the driver of the DRAM arrays. Each DRAM control input ( $\overline{WE}$ ) has capacitive loading between 5pF to 7pF, while each address line input has about a 10pF load.

Thus each DRAM input can be modeled as a transmission line with distributed inductance and capacitance. If not properly terminated, signal reflections and ringing on the line will result, adversely affecting the performance of the memory system. The effects on signal transitions will be:

1. Increased settling time delay on low-to-high transitions.
2. Voltage undershoot on high-to-low transitions.

### EFFECT OF DAMPING RESISTOR

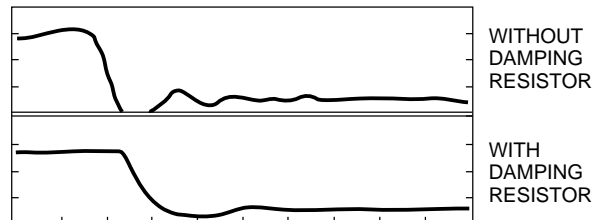

Courtesy of B. Narasimhan and J. Shaffer, Micron Technology Corporation.

Increased settling time due to ringing reduces system performance because the design has to allow for the settling delay before sampling the signal. Undershoot, by bringing the input voltage below 0 volts, can damage the driver IC as well as alter the DRAM's internal address register contents, causing potential loss of data.

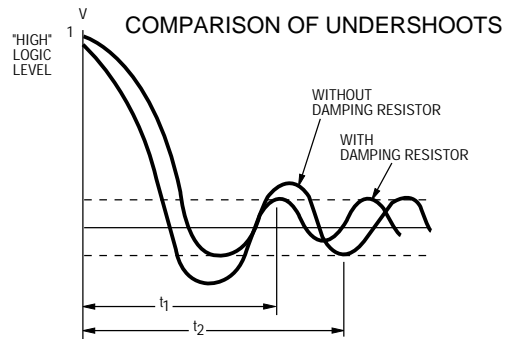

$t_1$  - TIME TO ACCEPTABLE "LOW" LOGIC LEVEL FOR DRIVER WITHOUT DAMPING RESISTOR  
 $t_2$  - TIME TO ACCEPTABLE "LOW" LOGIC LEVEL WITH DAMPING RESISTOR

## Application Guidelines

Termination of address and control lines is typically accomplished with low-valued resistors placed in series at the driver output. Selection of the proper resistance value is performed in two steps: approximation of the proper resistance using transmission line equations, and secondly, through trial and error, changing the resistance value to account for real world deviations such as PCB vias and bends.

The appropriate transmission line equations are as follows:

$$Z_0 = \text{characteristic line impedance (microstrip)}$$

$$= \sqrt{\frac{87}{\epsilon_r + 1.41}} \ln \left( \frac{5.98h}{0.8w + t} \right) \text{ ohms}$$

$$T_d = \text{propagation delay of the line}$$

$$= 1.017 \sqrt{0.475\epsilon_r + 0.67} \text{ ns/in.}$$

$$C_0 = \text{trace capacitance} = 1000 (T_d/Z_0) \text{ pF/in.}$$

$$C_d = \text{equivalent trace capacitance associated with each DRAM. It takes 0.5 inch to interconnect one DRAM.}$$

$$= 3.5\text{pF}/0.5 \text{ in.} = 7 \text{ pF/in.}$$

$$Z_0' = \text{effective characteristic impedance, accounting for capacitive loading of the DRAMs.}$$

$$= \frac{Z_0}{\sqrt{1 + C_d/C_0}}$$

$$T_d' = \text{effective propagation delay, accounting for the capacitive loading of the DRAMs}$$

$$T_d = T_d' \sqrt{1 + C_d/C_0}$$

where  $\epsilon_r$  = relative dielectric constant of the PCB's glass epoxy layer

$h$  = distance from the trace to the ground plane

$w$  = width of trace

$t$  = thickness of trace

For example, for a trace with the following characteristics:

$$\epsilon_r = 5 \text{ (for G10 glass epoxy)}$$

$$h = 30 \text{ mils}$$

$$w = 15 \text{ mils}$$

$$t = 3 \text{ mils}$$

$$\text{then, } Z_0 = 85 \text{ ohms}$$

$$T_d = 0.15 \text{ ns/in.}$$

$$C_0 = 1.76 \text{ pF/in.}$$

$$Z_0' = 38 \text{ ohms}$$

$$T_d' = 0.35 \text{ ns/in.}$$

Thus on a theoretical basis, the design will require the resistance of 38 ohms to match the trace impedance of the PCB.

However, the actual impedance will differ from this theoretical value due to the non-ideal characteristics of the PCB trace geometry (i.e., bends, curves and vias in the trace), as well as the manufacturing variations inherent in the components and materials. Therefore, a trial-and-error process must be employed in order to optimize the value of the damping resistor.

The procedure involves selecting various values around the calculated value and observing the resulting waveforms on an oscilloscope. Choose the value that best balances the reduction in ringing/reflection and the reduction in speed: a large resistance value provides better damping, but will also add delay by slowing the edge rate. Typically, resistance values for memory damping will be in the range of 10 ohms to 50 ohms, with the most common values in the 20 ohm to 30 ohm range.

Since memory damping is a type of series termination, distributed loading along the line will not be possible. That is, the entire lumped load must be located at the end of the line, with no other loads along the signal path. This will guarantee that the waveform will remain undisturbed as it travels along the line. For related reasons, the placement of the series damping resistor should be as close to the driving device as possible.

(Ref. MMI Systems Design Handbook, pp. 10-5 and 10-6.)



## Bourns Networks For Memory Damping

Bourns can supply a wide range of standard resistor networks for memory damping applications. Standard resistance values (see below) are normally in stock. However, any intermediate value within the range 10 ohms to 10 megohms can be supplied.

The following package and pin count options are available:

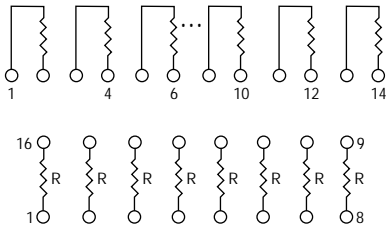

NUMBER OF LINES				
	2	3	4	5
MSIP*	4304M-102-RC	4306R-102-RC	4308R-102-RC	4310R-102-RC
CSIP*	4604X-102-RC	4606X-102-RC	4608X-102-RC	4610X-102-RC
PCC				4210P-102-RC
<b>6</b>				
MSIP*	4612X-102-RC			
CSIP*				
PCC				
	7	8	9	10
DIP	4114R-1-RC	4116R-1-RC	4118R-1-RC	4120R-1-RC
CSIP*	4614X-102-RC			
SOM	4814P-1-RC	4816P-1-RC		
SOL		4416P-1-RC		4420P-1-RC
SOL-J		4416J-1-RC		4420J-1-RC
PCC				4420P-102-RC

\*MEDIUM PROFILE (.250" SEATED HEIGHT) AND HIGH PROFILE (.350" SEATED HEIGHT) ARE AVAILABLE BY PLACING THE LETTER "M" OR "H," RESPECTIVELY, IN THE FIFTH POSITION OF THE PART NUMBER.

# Thin Film Applications



Thin film is the preferred generic description for the field of micro-electronics in which conductive, resistive, and/or insulating films are deposited or sputtered on a ceramic or other insulating substrate. The films can be deposited either in a required pattern or as a complete film layer and photoprocessed and etched to form the required pattern.

The term "thin film" is derived from the fact that the deposited films are of the order of a few micrometers in thickness compared with the 10 to 50 micrometers for thick film. Often, thin film conductors are plated to improve conductivity.

## Thin Film Applications

Thin film resistor networks typically find application in the analog world. The number one use of thin film is in controlling the gain on operational amplifiers. Some other applications are as a stable reference, stable voltage division, stable feedback loops and analog to digital or digital to analog conversion. These networks may also be used for "wire-OR" pull-up, ECL output pull-down, TTL input pull-down, power down pull-up, open collector pull-up, digital pulse squaring, current summing amplifiers, TTL unused gate pull-up, TTL/MOS interfacing, coding and decoding, and telemetry.

Thin film resistors in a network form offer additional benefits in performance. The resistors in a network are more closely matched in resistance and TCR and actually see reduced differentials of temperature in the end use application. These combine to provide improved tracking in networks. This improved tracking would be an advantage to the instrumentation and industrial control markets.

Potential target markets for thin film include harsh environmental conditions as well as the need for precision resistors. The improved ability to be stable at extended temperatures and the increased ability to handle moist environments are both benefits of the thin film offering. Target applications such as automotive and telecommunications will benefit from these capabilities.

## Thin Film Vs. Thick Film

The basic distinction between thick film and thin film is the method of deposition of the metallization. In thick film, specially formulated pastes are applied and fired onto a substrate. The pastes are usually applied with a silk screen method and the substrate is of 96% alumina ceramic. In thin film, a layer of metallization is sputtered onto a substrate and then a pattern is etched into the previously applied metal layer, the substrates are often 99.5% alumina ceramic, silicon, or glass. Thick film is an additive process where layers of termination and resistor material are added to the substrate, while thin film is a subtractive process where the unwanted material is etched away in a succession of selective photoetching processes. The use of photolithographic processes to form thin film patterns produce much

finer lines and traces than thick film processes. Thin film is very appropriate for high density and high frequency applications.

Thick and thin film technologies are well suited for low to medium volume custom circuits. Thick film has the advantages of lower cost (both of tooling up new designs and of production runs), of being able to handle more power, and of being able to service a higher range of ohmic values. Thin film has the advantages of tighter absolute and ratio tolerances and more environmentally stable components with lower noise and tighter TCR than thick film.

Thin film technology is used wherever precision resistors are needed.

## Differential Op-amp Input

Differential Op Amps are needed in electrically dirty environments to reject noise transients that are picked up by wires. The differential Op Amps subtracts the noise out of the two signal wires.

Thin film tracking capabilities are needed in these circuits to ensure that the input resistors do not affect the contents of the incoming signal.

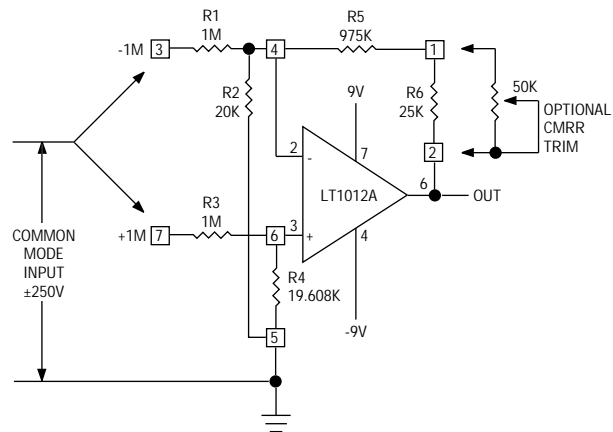

TYPICAL PERFORMANCE:  
 COMMON MODE REJECTION RATIO = 74dB (RESISTOR LIMITED)  
 WITH OPTIONAL TRIM = 130dB  
 OUTPUT OFFSET (TRIMMABLE TO ZERO) = 500µV  
 OUTPUT OFFSET DRIFT = 10µV/°C  
 INPUT RESISTANCE = 1M (CM)  
 2M (DIFF)  
 BANDWIDTH = 13KHz  
 BATTERY CURRENT = 370µA

±250V Common Mode Range Instrumentation Amplifier ( $A_v=1$ )

# Thin Film Applications



## Voltage Divider

Voltage dividers are used to step down voltages for analog processing. Applications are found in multi-meters, oscilloscopes, oscillator stage of voltage control oscillators, etc. The application needs precise resistors to ensure that errors are not added during the conversion process.

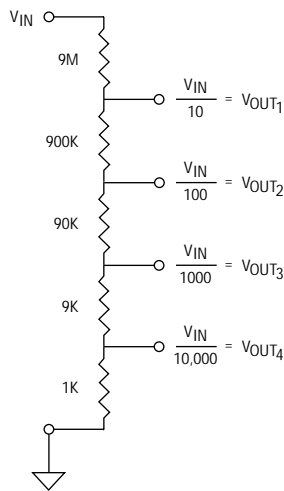

## THICK FILM VS. THIN FILM STANDARD VS. PRECISION

Parameter	Thick Film Circuits	Thin Film Circuits
Resistance	3 Ω to 20MΩ	10Ω to 100KΩ
Resistance Tolerance	.5%, 1%, 2%, 5%	.1%, .2%, .5%
TCR	±100ppm/°C	±25ppm/°C
TCR Tracking	100ppm/°C	5ppm/°C
Operating Temperature	-55°C to +125°C	-55°C to +125°C
Max. Operating Voltage	100 volts	50 volts
Resistor Power	.125W to .5W	.1W to .2W

## Data Conversion

Data converters are used to convert digital data to analog signals or vice versa. The precision of the high bit affects the overall precision of the data converter. Thus, thick film resistors are used in the lower bits while the thin film or bulk foil resistors are used in the high order bits.

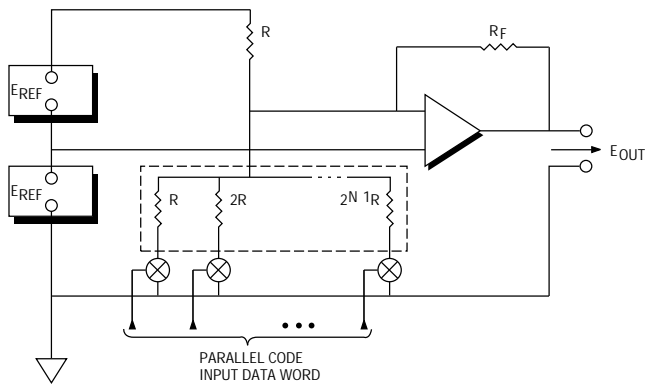

Parallel bit conductance switching D/A converter.

This application note is designed to provide step-by-step processing recommendations. It covers the popular soldering process currently in use and provides recommendations and cautions for each step. Since many variations of time, temperature, processes, cleaning agents and board types in use, you will want to verify your own system. Bourns does not recommend the backside mounting of passive components.

The process steps, recommendations and cautions are based on Bourns surveys of users, equipment manufacturers and materials suppliers. No warranty expressed or implied is made in regards to the following recommendations.

## 1



### Solder Paste Printing

Reflow; Convection, IR and Vapor Phase

#### GENERAL

Use the optimum solder paste for the pattern, printing process, and solder joint quality.

#### RECOMMENDED

Typical solder paste alloy is 63Sn/37Pb. RMA, No-Clean or Halide Free Water Soluble fluxes should be used.

#### CAUTION

Since solder paste usually contains a high percentage of activators, you must ensure adequate cleaning to remove all residues. Consult your solder paste supplier for cleaning methods. When cleaning additives are needed, only those that are Halide Free should be used.

## 2



### Adhesive Application

#### GENERAL

The adhesive must hold the unit in correct orientation upon placement and maintain the correct position during any physical handling before the final soldering process.

#### RECOMMENDED

To assure positional stability, place a single dot of epoxy under the unit.

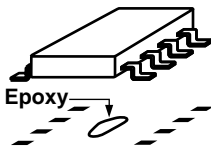

#### CAUTION

Use sufficient adhesive to assure stability through the cure process.

Avoid overflow of epoxy onto solder pads and terminal areas.

Excessive curing before placement may not allow full seating of the part causing incomplete solder connections.

## 3

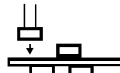

### Network Placement

#### GENERAL

Use pick-and-place equipment with a vacuum nozzle ID that allows adequate suction to pick the unit out of the pocket cavity.

#### RECOMMENDED

Ensure nozzle inside diameter and vacuum levels are adequate to maintain suction and part alignment.

#### CAUTION

Ensure parts are placed so that all leads are centered on the solder pads.

Align the leads with the solder belt direction of travel to avoid the part body creating a thermal shadowing effect.

Excessive placement force to the part should be avoided to minimize the risk of package damage.

## 4

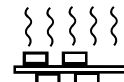

### Adhesive Cure

#### GENERAL

Heat/time cure should be accomplished using either an infrared radiation or a convection oven.

#### RECOMMENDED

Cure using the temperature profile specified by the adhesive manufacturer.

#### CAUTION

Use sufficient cure time to ensure complete adhesive transition from fluid to solid.

Care should be taken to assure the placed units are not exposed to temperatures in excess of the manufacturer's maximum.

Do not exceed the maximum temperature rating of the component.

## 5



### Flux Application

Flow (Wave)

#### GENERAL

Use the correct flux to remove surface oxides, prevent re-oxidation and promote wetting.

#### RECOMMENDED

RMA (Rosin Mildly Activated) flux or Halide Free Water Soluble flux is recommended.

#### CAUTION

Avoid fluxes with Halide activators.



These are the common methods, materials and maximum temperature/time parameters for soldering and cleaning processes:

Process Step	Soldering/Cleaning Methods				Material
	REFLOW		FLOW		
	Hot Air, Infrared (Solvent)	Vapor Phase (Solvent)	Wave (Solvent)	Wave (Aqueous)	
1. Solder Paste Printing	X	X			RMA
2. Adhesive Application			X	X	Epoxy
3. Switch Placement	X	X	X	X	
4. Adhesive Cure			X	X	
5. Flux Application			X		Rosin
5. Flux Application				X	Organic Acid
6. Solder (Reflow)	X	X			63/37 Sn/Pb
7. Solder (Flow)			X	X	63/37 Sn/Pb
8. Wash (Solvent)	X	X	X		ODS Free
9. Wash (Aqueous)				X	DI H <sub>2</sub> O; Detergent
High Pressure Fluids				X	
Ultrasonics	X	X	X		
Max. Temp.(°C)/Time (Seconds)	240/30	215/180	260/5	260/5	

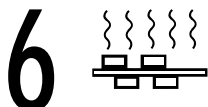

## Solder

Reflow; Convection, IR and Vapor Phase

### GENERAL

Preheat sufficiently using both time and temp. to bring the flux to activation and minimize thermal shock. Consult your solder paste supplier for the recommended profile.

### RECOMMENDED

Typical IR/Convection profile.

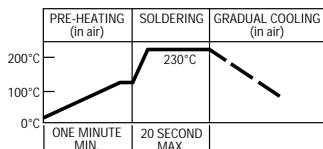

Use convection or Vapor Phase when possible and minimize the time above reflow temperature.

### CAUTION

Do not exceed time and temperature reflow profile of 240°C for 30 sec. for Hot Air/IR reflow and 215°C for 3 minutes for vapor phase reflow.

Minimize thermal shock by limiting temperature ramps to 3°C/sec. and by stabilizing board and component temperature during preheating.

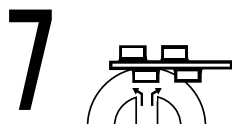

## Solder

Flow (Wave)

### GENERAL

For maximum component reliability and performance, minimize the time of temp. exposure above 200°C.

### RECOMMENDED

Typical alloy is Sn63/Pb37. A typical wave solder zone profile is 245°C for 5 sec.

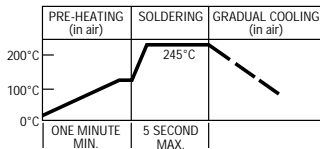

### CAUTION

Always preheat before the solder wave using the temperature for flux activation recommended by the manufacturer.

Do not exceed 240°C peak temperature for dual wave solder process with a flow zone totaling 5 seconds.

Minimize thermal shock by limiting temperature ramps to 3°C/sec. and by stabilizing board and component temperature during preheating.

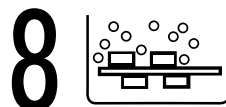

## Wash

Solvent

### GENERAL

Use solvent cleaning primarily for nonpolar contaminants such as rosin based flux residues.

### RECOMMENDED

Use any suitable washing solvents that meet ODS requirements.

### CAUTION

Limit excessive direct spray pressure to 60 psi.

Allow the assembly to sufficiently cool prior to the washing operation for minimized thermal stress.

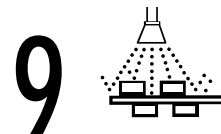

## Wash

Aqueous

### GENERAL

Use aqueous cleaning primarily for polar contaminants such as organic flux residues.

### RECOMMENDED

Use De-ionized or Reverse Osmosis water with multistage rinsing. Post bake at 100°C for 30 minutes to remove any residual moisture.

### CAUTION

Limit excessive direct spray pressure to 60 psi.

Allow the assembly to sufficiently cool prior to the washing operation for minimized thermal stress.

## Board Rework Technique

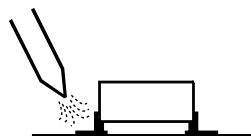

### GENERAL

Excessive and/or repeated high temperature exposure may affect the component performance and reliability.

### RECOMMENDED

Hot air reflow technique is preferred. Use No Clean or Rosin based fluxes only, OA fluxes are recommended.

### CAUTION

Avoid the use of wave soldering or soldering irons as a rework technique. Avoid repeated and excessive temperature exposure.

