

PLEASE CHECK WWW.MOLEX.COM FOR LATEST PART INFORMATION

Part Number: [0781271138](#)
Status: **Active**
Overview: ffc_fpc_smt
Description: 0.50mm (.020") Pitch FFC/FPC Connector, SMT, Non ZIF, Vertical, Reverse, Gold Plating, 13 Circuits, Lead Free

Documents:

[3D Model](#) [Product Specification PS-78119-001 \(PDF\)](#)
[Drawing \(PDF\)](#) [RoHS Certificate of Compliance \(PDF\)](#)

Agency Certification

CSA LR19980
 UL E29179

General

Product Family FFC/FPC Connectors
 Series [78127](#)
 Overview [ffc_fpc_smt](#)
 Product Name N/A

Physical

Circuits (Loaded) 13
 Circuits (maximum) 13
 Color - Resin Natural
 Contact Position N/A
 Durability (mating cycles max) 20
 Entry Angle Vertical
 Flammability 94V-0
 Mated Height (in) 0.161 In
 Mated Height (mm) 4.10 mm
 Material - Metal Copper Alloy
 Material - Plating Mating Gold, Nickel
 Number of Rows 1
 Orientation Vertical
 PCB Locator No
 PCB Retention None
 Packaging Type Embossed Tape on Reel
 Pitch - Mating Interface (in) 0.020 In
 Pitch - Mating Interface (mm) 0.50 mm
 Pitch - Term. Interface (in) 0.020 In
 Pitch - Term. Interface (mm) 0.50 mm
 Polarized to PCB No
 Stackable No
 Temperature Range - Operating -40°C to +85°C
 Termination Interface: Style Surface Mount
 Wire/Cable Type FFC/FPC

Electrical

Current - Maximum per Contact 0.5A
 Voltage - Maximum 50V AC

Material Info

Reference - Drawing Numbers

Product Specification PS-78119-001
 Sales Drawing SD-78127-001

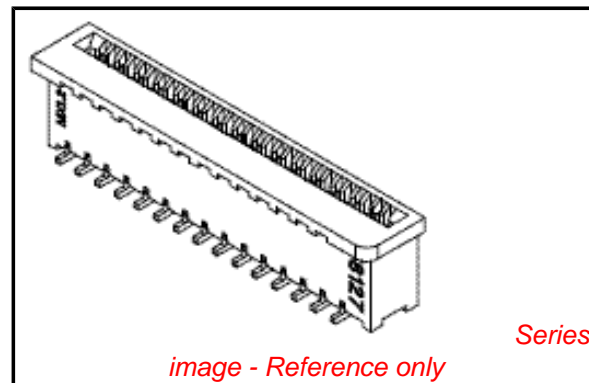

image - Reference only

EU RoHS

**ELV and RoHS
 Compliant**
**REACH SVHC
 Contains SVHC: No**
**Halogen-Free
 Status
 Not Reviewed**

China RoHS



**Need more information on product
 environmental compliance?**

Email productcompliance@molex.com
 For a multiple part number RoHS Certificate of Compliance, [click here](#)

Please visit the [Contact Us](#) section for any non-product compliance questions.

Search Parts in this Series

78127Series

Mates With

Standard FFC/FPC Cables

This document was generated on 06/07/2010

PLEASE CHECK WWW.MOLEX.COM FOR LATEST PART INFORMATION

10 9 8 7 6 5 4 3 2 1

F

E

D

C

B

A

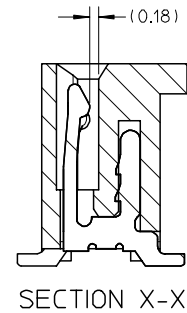
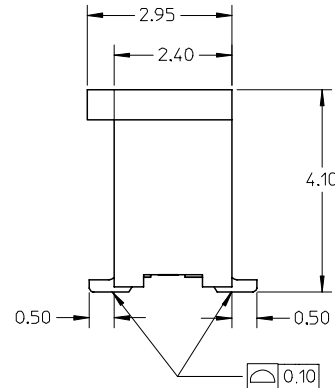
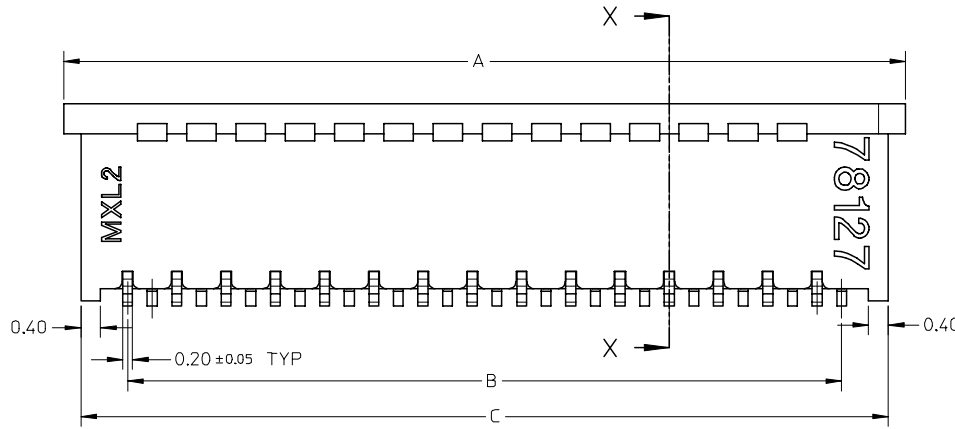
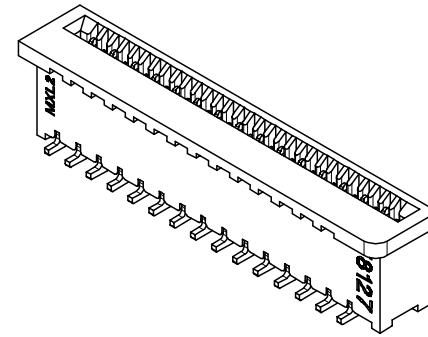
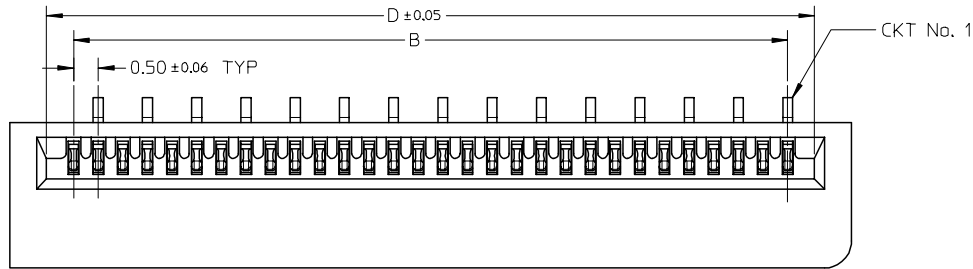

NOTE:

1. MATERIAL:
HOUSING: PA46 GLASS FILLED, UL94V-0, COLOR: NATURAL
TERMINAL: COPPER ALLOY
2. PLATING:
1) 0.10 μm MIN. GOLD PLATING OVER NICKEL PLATING OVERALL
2) 1-3 μm TIN-BISMUTH PLATING OVER NICKEL PLATING OVERALL
3. PRODUCT SPECIFICATION: PS-78119-001
4. PRODUCT ARE PACKED IN TAPE & REEL.

REVISED	DESCRIPTION
EC NO: S2007-0721	2007/03/05
DRWN: BOKOK	2007/03/05
CHKD: CGOH	
APPR: KCLING	2007/03/05
A1	REV

QUALITY SYMBOLS	▽=0
	∇=0

GENERAL TOLERANCES (UNLESS SPECIFIED)	
	mm INCH
4 PLACES	± --- ± ---
3 PLACES	± --- ± ---
2 PLACES	± 0.15 ± ---
1 PLACE	± --- ± ---
ANGULAR ± 3 °	
DRAFT WHERE APPLICABLE MUST REMAIN WITHIN DIMENSIONS	

DIMENSION STYLE	
MM ONLY	
DRAWN BY	DATE
YLQ1A0	2006/05/05
CHECKED BY	DATE
BOKOK	2006/06/06
APPROVED BY	DATE
PTL IM	2006/06/06
MATERIAL NO.	
SEE TABLE	
SIZE	
A3	

SCALE	DESIGN UNITS	THIRD ANGLE PROJECTION
NTS	METRIC	
TITLE		
0.50MM PITCH, FPC CONN. NON-ZIF, SMT		
MOLEX INCORPORATED		
DOCUMENT NO.	SHEET NO.	
SD-78127-001	1 OF 7	

9 8 7 6 5 4 3 2 1

10 9 8 7 6 5 4 3 2 1

F

E

D

C

B

A

F

E

D

C

B

A

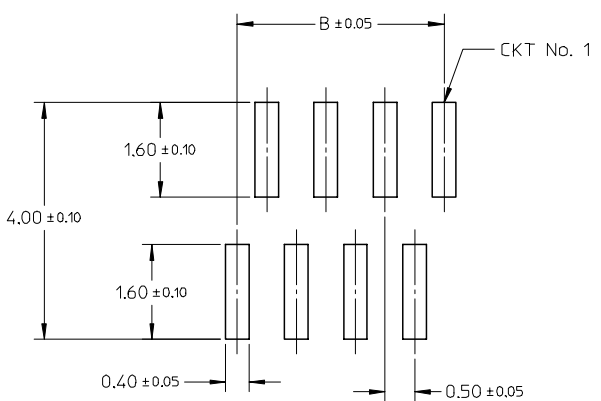

RECOMMENDED PCB LAYOUT

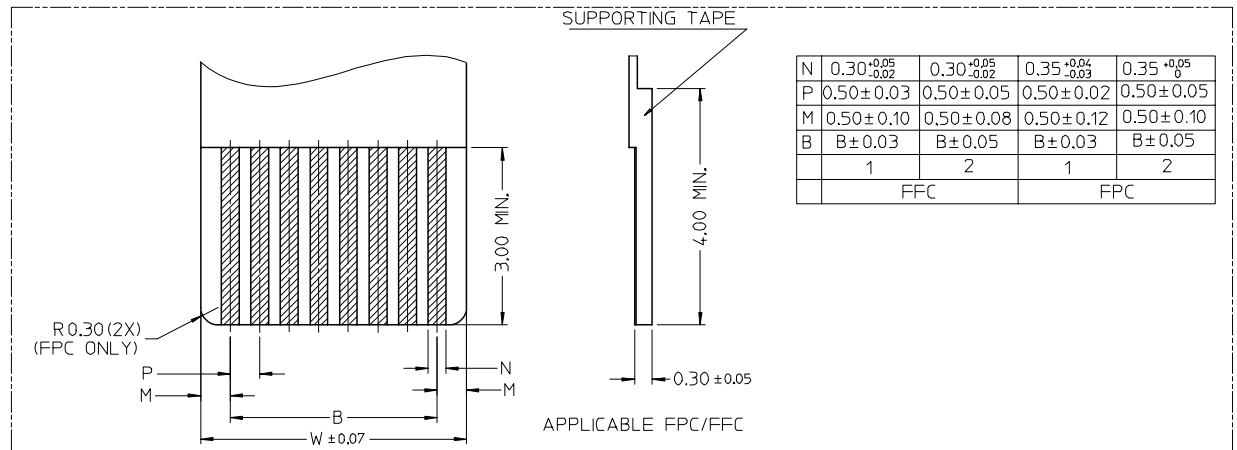

N	0.30 ^{+0.05} _{-0.02}	0.30 ^{+0.05} _{-0.02}	0.35 ^{+0.04} _{-0.03}	0.35 ^{+0.05} ₀
P	0.50 ± 0.03	0.50 ± 0.05	0.50 ± 0.02	0.50 ± 0.05
M	0.50 ± 0.10	0.50 ± 0.08	0.50 ± 0.12	0.50 ± 0.10
B	B ± 0.03	B ± 0.05	B ± 0.03	B ± 0.05
	1	2	1	2
	FFC		FPC	

REVISED EC NO: S2007-0721 DRWN: BOKOK CHKD: CGOH APPR: KCLING	2007/03/05 2007/03/05 2007/03/05	QUALITY SYMBOLS ▽=0 ▽=0	GENERAL TOLERANCES (UNLESS SPECIFIED)		DIMENSION STYLE MM ONLY		SCALE NTS	DESIGN UNITS METRIC	THIRD ANGLE PROJECTION	
	4 PLACES ± --- ± --- 3 PLACES ± --- ± --- 2 PLACES ± 0.15 ± --- 1 PLACE ± --- ± ---		mm INCH	DRAWN BY YLQ1A0	DATE 2006/05/05	TITLE 0.50MM PITCH, FPC CONN. NON-ZIF, SMT				
	ANGULAR ± 3 °		CHECKED BY BOKOK	DATE 2006/06/06	MOLEX INCORPORATED					
	DRAFT WHERE APPLICABLE MUST REMAIN WITHIN DIMENSIONS		APPROVED BY PTLIM	DATE 2006/06/06	MATERIAL NO. SEE TABLE	DOCUMENT NO. SD-78127-001	SHEET NO. 2 OF 7			
A1	REV				SIZE A3	THIS DRAWING CONTAINS INFORMATION THAT IS PROPRIETARY TO MOLEX INCORPORATED AND SHOULD NOT BE USED WITHOUT WRITTEN PERMISSION				

9 8 7 6 5 4 3 2 1

GOLD PLATING TERMINAL ASSEMBLY PART NUMBERS

ASSY P/N W/O PACKAGING	CKT	DIM A	DIM B	DIM C	DIM D	PLATING TYPE
78127-0068	6	5.10	2.50	4.40	3.60	1
78127-0078	7	5.60	3.00	4.90	4.10	
78127-0088	8	6.10	3.50	5.40	4.60	
78127-0098	9	6.60	4.00	5.90	5.10	
78127-0108	10	7.10	4.50	6.40	5.60	
78127-0118	11	7.60	5.00	6.90	6.10	
78127-0128	12	8.10	5.50	7.40	6.60	
78127-0138	13	8.60	6.00	7.90	7.10	
78127-0148	14	9.10	6.50	8.40	7.60	
78127-0158	15	9.60	7.00	8.90	8.10	
78127-0168	16	10.10	7.50	9.40	8.60	
78127-0178	17	10.60	8.00	9.90	9.10	
78127-0188	18	11.10	8.50	10.40	9.60	
78127-0198	19	11.60	9.00	10.90	10.10	
78127-0208	20	12.10	9.50	11.40	10.60	
78127-0218	21	12.60	10.00	11.90	11.10	
78127-0228	22	13.10	10.50	12.40	11.60	
78127-0238	23	13.60	11.00	12.90	12.10	
78127-0248	24	14.10	11.50	13.40	12.60	
78127-0258	25	14.60	12.00	13.90	13.10	
78127-0268	26	15.10	12.50	14.40	13.60	
78127-0278	27	15.60	13.00	14.90	14.10	
78127-0288	28	16.10	13.50	15.40	14.60	
78127-0298	29	16.60	14.00	15.90	15.10	
78127-0308	30	17.10	14.50	16.40	15.60	

ASSY P/N W/O PACKAGING	CKT	DIM A	DIM B	DIM C	DIM D	PLATING TYPE
78127-0318	31	17.60	15.00	16.90	16.10	1
78127-0328	32	18.10	15.50	17.40	16.60	
78127-0338	33	18.60	16.00	17.90	17.10	
78127-0348	34	19.10	16.50	18.40	17.60	
78127-0358	35	19.60	17.00	18.90	18.10	
78127-0368	36	20.10	17.50	19.40	18.60	
78127-0378	37	20.60	18.00	19.90	19.10	
78127-0388	38	21.10	18.50	20.40	19.60	
78127-0398	39	21.60	19.00	20.90	20.10	
78127-0408	40	22.10	19.50	21.40	20.60	
78127-0418	41	22.60	20.00	21.90	21.10	
78127-0428	42	23.10	20.50	22.40	21.60	

REVISED EC NO: S2007-0721 DRWN: BOKOK CHKD: CGOH APPR: KCLING 2007/03/05 2007/03/05 2007/03/05	QUALITY SYMBOLS ▽=0 ▽=0	GENERAL TOLERANCES (UNLESS SPECIFIED)		DIMENSION STYLE MM ONLY		SCALE NTS	DESIGN UNITS METRIC	THIRD ANGLE PROJECTION			
		4 PLACES ± --- ± --- 3 PLACES ± --- ± --- 2 PLACES ± 0.15 ± --- 1 PLACE ± --- ± ---		mm INCH		DRAWN BY DATE YLQ1A0 2006/05/05		TITLE 0.50MM PITCH, FPC CONN. NON-ZIF, SMT			
		ANGULAR ± 3 °		DRAFT WHERE APPLICABLE MUST REMAIN WITHIN DIMENSIONS		CHECKED BY DATE BOKOK 2006/06/06		APPROVED BY DATE PTL IM 2006/06/06			
		MATERIAL NO.		SEE TABLE		DOCUMENT NO. SD-78127-001		SHEET NO. 3 OF 7			

10 9 8 7 6 5 4 3 2 1

F

F

TIN-BISMUTH PLATING TERMINAL ASSEMBLY PART NUMBERS

ASSY P/N W/O PACKAGING	CKT	DIM A	DIM B	DIM C	DIM D	PLATING TYPE
78127-0069	6	5.10	2.50	4.40	3.60	2
78127-0079	7	5.60	3.00	4.90	4.10	
78127-0089	8	6.10	3.50	5.40	4.60	
78127-0099	9	6.60	4.00	5.90	5.10	
78127-0109	10	7.10	4.50	6.40	5.60	
78127-0119	11	7.60	5.00	6.90	6.10	
78127-0129	12	8.10	5.50	7.40	6.60	
78127-0139	13	8.60	6.00	7.90	7.10	
78127-0149	14	9.10	6.50	8.40	7.60	
78127-0159	15	9.60	7.00	8.90	8.10	
78127-0169	16	10.10	7.50	9.40	8.60	
78127-0179	17	10.60	8.00	9.90	9.10	
78127-0189	18	11.10	8.50	10.40	9.60	
78127-0199	19	11.60	9.00	10.90	10.10	
78127-0209	20	12.10	9.50	11.40	10.60	
78127-0219	21	12.60	10.00	11.90	11.10	
78127-0229	22	13.10	10.50	12.40	11.60	
78127-0239	23	13.60	11.00	12.90	12.10	
78127-0249	24	14.10	11.50	13.40	12.60	
78127-0259	25	14.60	12.00	13.90	13.10	
78127-0269	26	15.10	12.50	14.40	13.60	
78127-0279	27	15.60	13.00	14.90	14.10	
78127-0289	28	16.10	13.50	15.40	14.60	
78127-0299	29	16.60	14.00	15.90	15.10	
78127-0309	30	17.10	14.50	16.40	15.60	

ASSY P/N W/O PACKAGING	CKT	DIM A	DIM B	DIM C	DIM D	PLATING TYPE
78127-0319	31	17.60	15.00	16.90	16.10	2
78127-0329	32	18.10	15.50	17.40	16.60	
78127-0339	33	18.60	16.00	17.90	17.10	
78127-0349	34	19.10	16.50	18.40	17.60	
78127-0359	35	19.60	17.00	18.90	18.10	
78127-0369	36	20.10	17.50	19.40	18.60	
78127-0379	37	20.60	18.00	19.90	19.10	
78127-0389	38	21.10	18.50	20.40	19.60	
78127-0399	39	21.60	19.00	20.90	20.10	
78127-0409	40	22.10	19.50	21.40	20.60	
78127-0419	41	22.60	20.00	21.90	21.10	
78127-0429	42	23.10	20.50	22.40	21.60	

E

E

D

D

C

C

B

B

A

A

REVISED
EC NO: S2007-0721
DRWN: BOKOK
CHKD: CGOH
APPR: KCLING

QUALITY SYMBOLS
▽=0
▽C=0

GENERAL TOLERANCES (UNLESS SPECIFIED)

	mm	INCH
4 PLACES	± ---	± ---
3 PLACES	± ---	± ---
2 PLACES	± 0.15	± ---
1 PLACE	± ---	± ---

ANGULAR ± 3 °

DRAFT WHERE APPLICABLE
MUST REMAIN WITHIN DIMENSIONS

DIMENSION STYLE
MM ONLY

DRAWN BY YLQIAO
DATE 2006/05/05

CHECKED BY BOKOK
DATE 2006/06/06

APPROVED BY PTL IM
DATE 2006/06/06

MATERIAL NO.

SIZE A3

SCALE NTS
DESIGN UNITS METRIC

THIRD ANGLE PROJECTION

TITLE 0.50MM PITCH, FPC CONN.
NON-ZIF, SMT

MOLEX INCORPORATED

DOCUMENT NO. SD-78127-001

SHEET NO. 4 OF 7

THIS DRAWING CONTAINS INFORMATION THAT IS PROPRIETARY TO MOLEX INCORPORATED AND SHOULD NOT BE USED WITHOUT WRITTEN PERMISSION

9 8 7 6 5 4 3 2 1

EMBOSSED TYPE A

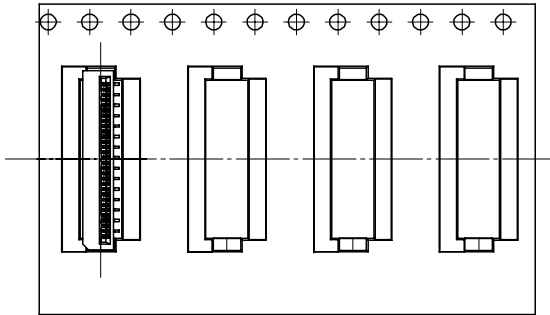

CUSTOMER
PULL OUT DIRECTION

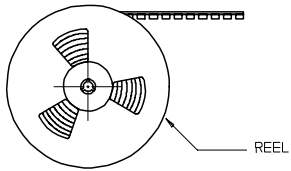

REEL

NOTES:

1. LEADER AND TRAILER TAPE

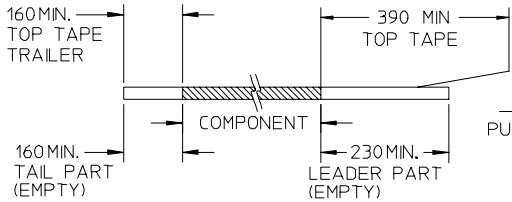

PULL OUT DIRECTION

2. PEELING OFF FORCE OF THE TOP TAPE: 20-80gf.
(PEELING DIRECTION AS SHOWN IN FOLLOWING FIGURE)

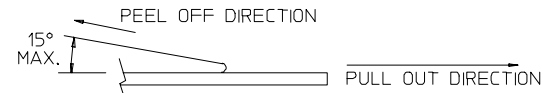

3. PACKAGING STANDARD IS AS PER EIA-481.

4. TAPE & REEL QUANTITY = 1000 PCS/REEL

EMBOSSED TYPE B

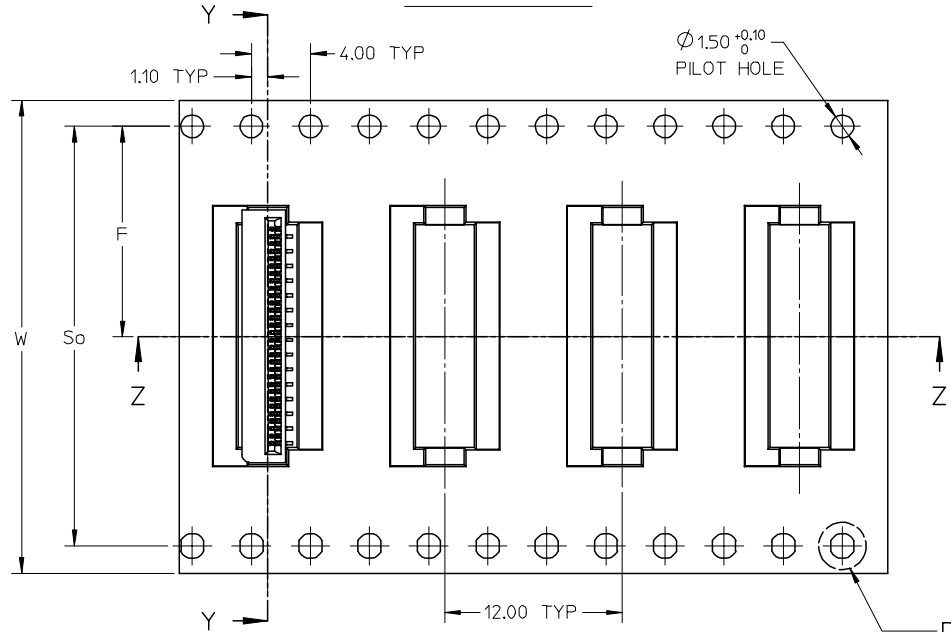

DETAIL 1

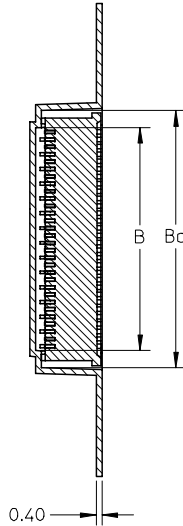

SECTION Y-Y

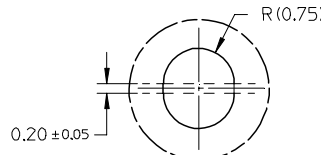

DETAIL 1

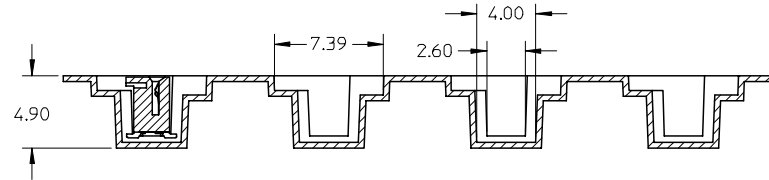

SECTION Z-Z

REVISED	QUALITY SYMBOLS	DESCRIPTION
EC NO: S2007-0721	▽=0	
2007/03/05	▽=0	
DRWN:80K0K		
2007/03/05		
CHKD:CGH		
2007/03/05		
APPR:KCLING		
2007/03/05		
A1		

GENERAL TOLERANCES (UNLESS SPECIFIED)	
mm	INCH
4 PLACES ± ---	± ---
3 PLACES ± ---	± ---
2 PLACES ± 0.15	± ---
1 PLACE ± ---	± ---
ANGULAR ± 3°	
DRAFT WHERE APPLICABLE MUST REMAIN WITHIN DIMENSIONS	

DIMENSION STYLE	
MM ONLY	
DRAWN BY	DATE
YLQ1A0	2006/05/05
CHECKED BY	DATE
BOKOK	2006/06/06
APPROVED BY	DATE
PTL IM	2006/06/06
MATERIAL NO.	
SEE TABLE	
SIZE	
A3	

SCALE	DESIGN UNITS	THIRD ANGLE PROJECTION	
NTS	METRIC		
TITLE		0.50MM PITCH, FPC CONN. NON-ZIF, SMT	
MOLEX INCORPORATED			
DOCUMENT NO.		SHEET NO.	
SD-78127-001		5 OF 7	
THIS DRAWING CONTAINS INFORMATION THAT IS PROPRIETARY TO MOLEX INCORPORATED AND SHOULD NOT BE USED WITHOUT WRITTEN PERMISSION			

10 9 8 7 6 5 4 3 2 1

GOLD PLATING TERMINAL ASSEMBLY PART NUMBERS

ASSY P/N PACKED IN T&R	ASSY P/N W/O PACKAGING	CKT	W	So	F	Bo	B	EMBOSSED TYPE
78127-1068	78127-0068	6	24.00	-	11.50	5.40	3.10	A
78127-1078	78127-0078	7	24.00	-	11.50	5.90	3.60	
78127-1088	78127-0088	8	24.00	-	11.50	6.40	4.10	
78127-1098	78127-0098	9	24.00	-	11.50	6.90	4.60	
78127-1108	78127-0108	10	24.00	-	11.50	7.40	5.10	
78127-1118	78127-0118	11	24.00	-	11.50	7.90	5.60	
78127-1128	78127-0128	12	24.00	-	11.50	8.40	6.10	
78127-1138	78127-0138	13	24.00	-	11.50	8.90	6.60	
78127-1148	78127-0148	14	24.00	-	11.50	9.40	7.10	
78127-1158	78127-0158	15	24.00	-	11.50	9.90	7.60	
78127-1168	78127-0168	16	24.00	-	11.50	10.40	8.10	
78127-1178	78127-0178	17	24.00	-	11.50	10.90	8.60	
78127-1188	78127-0188	18	24.00	-	11.50	11.40	9.10	
78127-1198	78127-0198	19	24.00	-	11.50	11.90	9.60	
78127-1208	78127-0208	20	24.00	-	11.50	12.40	10.10	
78127-1218	78127-0218	21	32.00	28.40	14.20	12.90	10.60	B
78127-1228	78127-0228	22	32.00	28.40	14.20	13.40	11.10	
78127-1238	78127-0238	23	32.00	28.40	14.20	13.90	11.60	
78127-1248	78127-0248	24	32.00	28.40	14.20	14.40	12.10	
78127-1258	78127-0258	25	32.00	28.40	14.20	14.90	12.60	
78127-1268	78127-0268	26	32.00	28.40	14.20	15.40	13.10	
78127-1278	78127-0278	27	32.00	28.40	14.20	15.90	13.60	
78127-1288	78127-0288	28	32.00	28.40	14.20	16.40	14.10	
78127-1298	78127-0298	29	32.00	28.40	14.20	16.90	14.60	
78127-1308	78127-0308	30	32.00	28.40	14.20	17.40	15.10	

ASSY P/N PACKED IN T&R	ASSY P/N W/O PACKAGING	CKT	W	So	F	Bo	B	EMBOSSED TYPE
78127-1318	78127-0318	31	32.00	28.40	14.20	17.90	15.60	B
78127-1328	78127-0328	32	32.00	28.40	14.20	18.40	16.10	
78127-1338	78127-0338	33	32.00	28.40	14.20	18.90	16.60	
78127-1348	78127-0348	34	32.00	28.40	14.20	19.40	17.10	
78127-1358	78127-0358	35	32.00	28.40	14.20	19.90	17.60	
78127-1368	78127-0368	36	32.00	28.40	14.20	20.40	18.10	
78127-1378	78127-0378	37	32.00	28.40	14.20	20.90	18.60	
78127-1388	78127-0388	38	32.00	28.40	14.20	21.40	19.10	
78127-1398	78127-0398	39	44.00	40.40	20.20	21.90	19.60	
78127-1408	78127-0408	40	44.00	40.40	20.20	22.40	20.10	
78127-1418	78127-0418	41	44.00	40.40	20.20	22.90	20.60	
78127-1428	78127-0428	42	44.00	40.40	20.20	23.40	21.10	

REVISED EC NO: S2007-0721 DRWN: BOKOK CHKD: CGOH APPR: KCLING 2007/03/05 2007/03/05 2007/03/05	QUALITY SYMBOLS ▽=0 ▽=0	GENERAL TOLERANCES (UNLESS SPECIFIED)		DIMENSION STYLE	SCALE	DESIGN UNITS	THIRD ANGLE PROJECTION		
				MM ONLY	NTS	METRIC			
				mm	INCH				
				4 PLACES ± ---	± ---				
		3 PLACES ± ---	± ---						
		2 PLACES ± 0.15	± ---						
		1 PLACE ± ---	± ---						
		ANGULAR ± 3 °							
		DRAFT WHERE APPLICABLE MUST REMAIN WITHIN DIMENSIONS		SEE TABLE					
				DRAWN BY YLQ1A0		DATE 2006/05/05			
				CHECKED BY BOKOK		DATE 2006/06/06			
				APPROVED BY PTL IM		DATE 2006/06/06			
				MATERIAL NO.		DOCUMENT NO.			
				SD-78127-001		SHEET NO. 6 OF 7			
				THIS DRAWING CONTAINS INFORMATION THAT IS PROPRIETARY TO MOLEX INCORPORATED AND SHOULD NOT BE USED WITHOUT WRITTEN PERMISSION					

9 8 7 6 5 4 3 2 1

10 9 8 7 6 5 4 3 2 1

TIN-BISMUTH PLATING TERMINAL ASSEMBLY PART NUMBERS

ASSY P/N PACKED IN T&R	ASSY P/N W/O PACKAGING	CKT	W	So	F	Bo	B	EMBOSSED TYPE	ASSY P/N PACKED IN T&R	ASSY P/N W/O PACKAGING	CKT	W	So	F	Bo	B	EMBOSSED TYPE		
78127-1069	78127-0069	6	24.00	-	11.50	5.40	3.10	A	78127-1319	78127-0319	31	32.00	28.40	14.20	17.90	15.60	B		
78127-1079	78127-0079	7	24.00	-	11.50	5.90	3.60		78127-1329	78127-0329	32	32.00	28.40	14.20	18.40	16.10			
78127-1089	78127-0089	8	24.00	-	11.50	6.40	4.10		78127-1339	78127-0339	33	32.00	28.40	14.20	18.90	16.60			
78127-1099	78127-0099	9	24.00	-	11.50	6.90	4.60		78127-1349	78127-0349	34	32.00	28.40	14.20	19.40	17.10			
78127-1109	78127-0109	10	24.00	-	11.50	7.40	5.10		78127-1359	78127-0359	35	32.00	28.40	14.20	19.90	17.60			
78127-1119	78127-0119	11	24.00	-	11.50	7.90	5.60		78127-1369	78127-0369	36	32.00	28.40	14.20	20.40	18.10			
78127-1129	78127-0129	12	24.00	-	11.50	8.40	6.10		78127-1379	78127-0379	37	32.00	28.40	14.20	20.90	18.60			
78127-1139	78127-0139	13	24.00	-	11.50	8.90	6.60		78127-1389	78127-0389	38	32.00	28.40	14.20	21.40	19.10			
78127-1149	78127-0149	14	24.00	-	11.50	9.40	7.10		78127-1399	78127-0399	39	44.00	40.40	20.20	21.90	19.60			
78127-1159	78127-0159	15	24.00	-	11.50	9.90	7.60		78127-1409	78127-0409	40	44.00	40.40	20.20	22.40	20.10			
78127-1169	78127-0169	16	24.00	-	11.50	10.40	8.10		78127-1419	78127-0419	41	44.00	40.40	20.20	22.90	20.60			
78127-1179	78127-0179	17	24.00	-	11.50	10.90	8.60		78127-1429	78127-0429	42	44.00	40.40	20.20	23.40	21.10			
78127-1189	78127-0189	18	24.00	-	11.50	11.40	9.10												
78127-1199	78127-0199	19	24.00	-	11.50	11.90	9.60												
78127-1209	78127-0209	20	24.00	-	11.50	12.40	10.10												
78127-1219	78127-0219	21	32.00	28.40	14.20	12.90	10.60												
78127-1229	78127-0229	22	32.00	28.40	14.20	13.40	11.10												
78127-1239	78127-0239	23	32.00	28.40	14.20	13.90	11.60												
78127-1249	78127-0249	24	32.00	28.40	14.20	14.40	12.10												
78127-1259	78127-0259	25	32.00	28.40	14.20	14.90	12.60												
78127-1269	78127-0269	26	32.00	28.40	14.20	15.40	13.10												
78127-1279	78127-0279	27	32.00	28.40	14.20	15.90	13.60												
78127-1289	78127-0289	28	32.00	28.40	14.20	16.40	14.10												
78127-1299	78127-0299	29	32.00	28.40	14.20	16.90	14.60												
78127-1309	78127-0309	30	32.00	28.40	14.20	17.40	15.10												

REVISED EC NO: S2007-0721 DRWN: BOKOK CHKD: CGOH APPR: KCLING 2007/03/05 2007/03/05 2007/03/05	QUALITY SYMBOLS ▽=0 ▽=0	GENERAL TOLERANCES (UNLESS SPECIFIED)		DIMENSION STYLE MM ONLY		SCALE NTS	DESIGN UNITS METRIC	THIRD ANGLE PROJECTION		
		4 PLACES ± --- ± ---	mm INCH	DRAWN BY YLQ1A0	DATE 2006/05/05	TITLE 0.50MM PITCH, FPC CONN. NON-ZIF, SMT				
		3 PLACES ± --- ± ---		CHECKED BY BOKOK	DATE 2006/06/06	MOLEX INCORPORATED				
		2 PLACES ± 0.15 ± ---		APPROVED BY PTL IM	DATE 2006/06/06	MATERIAL NO. SEE TABLE	DOCUMENT NO. SD-78127-001	SHEET NO. 7 OF 7		
1 PLACE ± --- ± ---		ANGULAR ± 3 °		DRAFT WHERE APPLICABLE MUST REMAIN WITHIN DIMENSIONS		THIS DRAWING CONTAINS INFORMATION THAT IS PROPRIETARY TO MOLEX INCORPORATED AND SHOULD NOT BE USED WITHOUT WRITTEN PERMISSION				
A1	REV									

9 8 7 6 5 4 3 2 1