

Stereo CODEC for Portable Audio Applications

DESCRIPTION

The WM8971L is a low power, high quality stereo codec designed for portable digital audio applications.

The device integrates complete interfaces to stereo or mono microphones and a stereo headphone. External component requirements are drastically reduced as no separate microphone or headphone amplifiers are required. Advanced on-chip digital signal processing performs graphic equaliser, and automatic level control for the microphone or line input.

The WM8971L can operate as a master or a slave, with various master clock frequencies including 12 or 24MHz for USB devices, or standard 256f_s rates like 12.288MHz and 24.576MHz. Different audio sample rates such as 96kHz, 48kHz, 44.1kHz are generated directly from the master clock without the need for an external PLL.

The WM8971L operates at supply voltages down to 1.8V, although the digital core can operate at voltages down to 1.42V to save power, and the maximum for all supplies is 3.6 Volts. Different sections of the chip can also be powered down under software control.

The WM8971L is supplied in a very small and thin 5x5mm QFN package, ideal for use in hand-held and portable systems.

FEATURES

- DAC SNR 98dB ('A' weighted), THD -84dB at 48kHz, 3.3V
- ADC SNR 95dB ('A' weighted), THD -82dB at 48kHz, 3.3V
- Complete Stereo / Mono Microphone Interface
 - Programmable ALC / Noise Gate
- On-chip 400mW BTL Speaker Driver (mono)
- On-chip Headphone Driver
 - >40mW output power on 16Ω / 3.3V
 - THD -80dB at 20mW, SNR 90dB with 16Ω load
 - No DC blocking capacitors required (capless mode)
- Separately mixed mono output
- Digital Graphic Equaliser
- Low Power
 - 7mW stereo playback (1.8V / 1.5V supplies)
 - 14mW record and playback (1.8V / 1.5V supplies)
- Low Supply Voltages
 - Analogue 1.8V to 3.6V
 - Digital core: 1.42V to 3.6V
 - Digital I/O: 1.8V to 3.6V
- 256fs / 384fs or USB master clock rates: 12MHz, 24MHz
- Audio sample rates: 8, 11.025, 16, 22.05, 24, 32, 44.1, 48, 88.2, 96kHz generated internally from master clock
- 5x5x0.9mm QFN package

APPLICATIONS

- Digital Still Cameras
- MP3 Player / Recorders
- Minidisc Player / Recorders
- Portable Digital Music Systems

BLOCK DIAGRAM

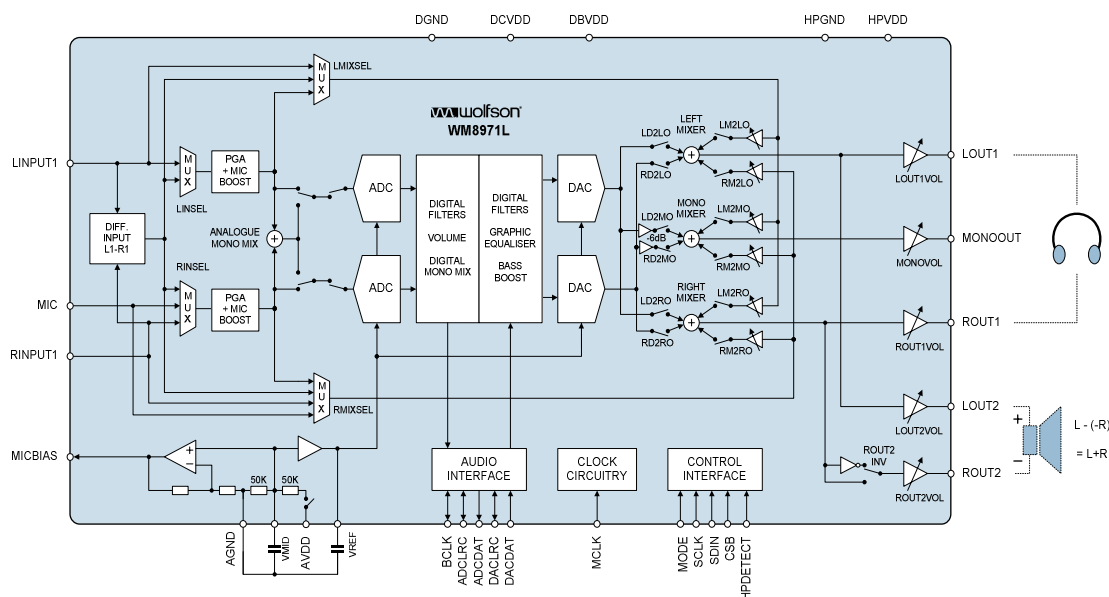
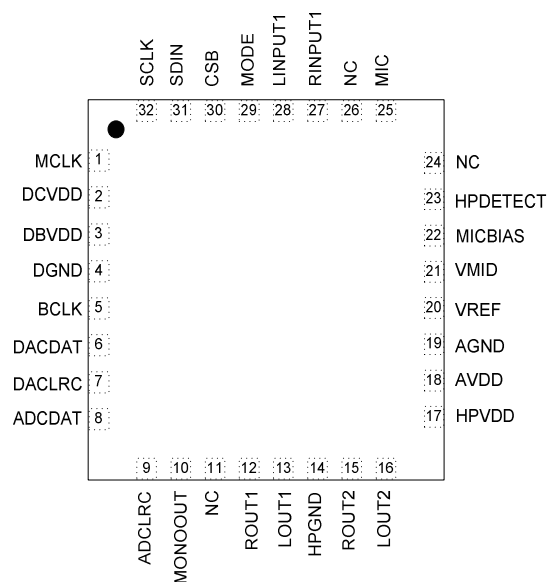

TABLE OF CONTENTS

| | |
|--|-----------|
| DESCRIPTION | 1 |
| FEATURES..... | 1 |
| APPLICATIONS | 1 |
| BLOCK DIAGRAM | 1 |
| TABLE OF CONTENTS | 2 |
| PIN CONFIGURATION..... | 4 |
| ORDERING INFORMATION | 4 |
| PIN DESCRIPTION | 5 |
| ABSOLUTE MAXIMUM RATINGS..... | 6 |
| RECOMMENDED OPERATION CONDITIONS | 6 |
| ELECTRICAL CHARACTERISTICS | 7 |
| OUTPUT PGA'S LINEARITY | 9 |
| HEADPHONE OUTPUT THD VERSUS POWER..... | 10 |
| SPEAKER THD AND NOISE VERSUS POWER | 11 |
| POWER CONSUMPTION | 12 |
| SIGNAL TIMING REQUIREMENTS | 13 |
| SYSTEM CLOCK TIMING..... | 13 |
| AUDIO INTERFACE TIMING – MASTER MODE | 13 |
| AUDIO INTERFACE TIMING – SLAVE MODE | 14 |
| INTERNAL POWER ON RESET CIRCUIT | 17 |
| DEVICE DESCRIPTION..... | 18 |
| INTRODUCTION..... | 18 |
| INPUT SIGNAL PATH..... | 18 |
| AUTOMATIC LEVEL CONTROL (ALC) | 25 |
| OUTPUT SIGNAL PATH..... | 28 |
| ANALOGUE OUTPUTS | 33 |
| ENABLING THE OUTPUTS..... | 35 |
| HEADPHONE SWITCH | 35 |
| THERMAL SHUTDOWN..... | 37 |
| HEADPHONE OUTPUT | 37 |
| DIGITAL AUDIO INTERFACE..... | 38 |
| AUDIO INTERFACE CONTROL | 42 |
| CLOCKING AND SAMPLE RATES..... | 44 |
| CONTROL INTERFACE | 46 |
| POWER SUPPLIES | 47 |
| POWER MANAGEMENT | 47 |
| REGISTER MAP..... | 50 |
| DIGITAL FILTER CHARACTERISTICS | 51 |
| TERMINOLOGY..... | 51 |
| DAC FILTER RESPONSES | 52 |
| ADC FILTER RESPONSES | 53 |
| DE-EMPHASIS FILTER RESPONSES | 54 |
| HIGHPASS FILTER | 55 |
| APPLICATIONS INFORMATION | 56 |
| RECOMMENDED EXTERNAL COMPONENTS..... | 56 |
| LINE INPUT CONFIGURATION..... | 57 |
| MICROPHONE INPUT CONFIGURATION | 57 |
| MINIMISING POP NOISE AT THE ANALOGUE OUTPUTS | 57 |
| POWER MANAGEMENT EXAMPLES | 58 |

| | |
|-------------------------------|-----------|
| IMPORTANT NOTICE | 60 |
| ADDRESS:..... | 60 |

PIN CONFIGURATION



ORDERING INFORMATION

| ORDER CODE | TEMPERATURE RANGE | PACKAGE | MOISTURE SENSITIVITY LEVEL | PEAK SOLDERING TEMPERATURE |
|---------------|-------------------|---|----------------------------|----------------------------|
| WM8971LGEFL | -25°C to +85°C | 32-lead QFN (5x5x0.9mm) (Pb-free) | MSL1 | 260°C |
| WM8971LGEFL/R | -25°C to +85°C | 32-lead QFN (5x5x0.9mm) (Pb-free, tape and reel) | MSL1 | 260°C |

Note:

Reel quantity = 3500

PIN DESCRIPTION

| PIN NO | NAME | TYPE | DESCRIPTION |
|--------|----------|------------------------|---|
| 1 | MCLK | Digital Input | Master Clock |
| 2 | DCVDD | Supply | Digital Core Supply |
| 3 | DBVDD | Supply | Digital Buffer (I/O) Supply |
| 4 | DGND | Supply | Digital Ground (return path for both DCVDD and DBVDD) |
| 5 | BCLK | Digital Input / Output | Audio Interface Bit Clock |
| 6 | DACDAT | Digital Input | DAC Digital Audio Data |
| 7 | DACLRC | Digital Input / Output | Audio Interface Left / Right Clock/Clock Out |
| 8 | ADCDAT | Digital Output | ADC Digital Audio Data |
| 9 | ADCLRC | Digital Input / Output | Audio Interface Left / Right Clock |
| 10 | MONOOUT | Analogue Output | Mono Output |
| 11 | NC | No Connect | No Connect |
| 12 | ROUT1 | Analogue Output | Right Output 1 (Line or Headphone) |
| 13 | LOUT1 | Analogue Output | Left Output 1 (Line or Headphone) |
| 14 | HPGND | Supply | Supply for Analogue Output Drivers (LOUT1/2, ROUT1/2) |
| 15 | ROUT2 | Analogue Output | Right Output 1 (Line or Headphone or Speaker) |
| 16 | LOUT2 | Analogue Output | Left Output 1 (Line or Headphone or Speaker) |
| 17 | HPVDD | Supply | Supply for Analogue Output Drivers (LOUT1/2, ROUT1/2, MONOUT) |
| 18 | AVDD | Supply | Analogue Supply |
| 19 | AGND | Supply | Analogue Ground (return path for AVDD) |
| 20 | VREF | Analogue Output | Reference Voltage Decoupling Capacitor |
| 21 | VMID | Analogue Output | Midrail Voltage Decoupling Capacitor |
| 22 | MICBIAS | Analogue Output | Microphone Bias |
| 23 | HPDETECT | Analogue Input | Headphone Plug-in Detection |
| 24 | NC | No Connect | No Connect |
| 25 | MIC | Analogue Input | Single Ended Microphone Input |
| 26 | NC | No Connect | No Connect |
| 27 | RINPUT1 | Analogue Input | Right Channel Input 1 |
| 28 | LINPUT1 | Analogue Input | Left Channel Input 1 |
| 29 | MODE | Digital Input | Control Interface Selection |
| 30 | CSB | Digital Input | Chip Select / Device Address Selection |
| 31 | SDIN | Digital Input/Output | Control Interface Data Input / 2-wire Acknowledge output |
| 32 | SCLK | Digital Input | Control Interface Clock Input |

Note:

It is recommended that the QFN ground paddle should be connected to analogue ground on the application PCB.

ABSOLUTE MAXIMUM RATINGS

Absolute Maximum Ratings are stress ratings only. Permanent damage to the device may be caused by continuously operating at or beyond these limits. Device functional operating limits and guaranteed performance specifications are given under Electrical Characteristics at the test conditions specified.



ESD Sensitive Device. This device is manufactured on a CMOS process. It is therefore generically susceptible to damage from excessive static voltages. Proper ESD precautions must be taken during handling and storage of this device.

Wolfson tests its package types according to IPC/JEDEC J-STD-020B for Moisture Sensitivity to determine acceptable storage conditions prior to surface mount assembly. These levels are:

MSL1 = unlimited floor life at <30°C / 85% Relative Humidity. Not normally stored in moisture barrier bag.

MSL2 = out of bag storage for 1 year at <30°C / 60% Relative Humidity. Supplied in moisture barrier bag.

MSL3 = out of bag storage for 168 hours at <30°C / 60% Relative Humidity. Supplied in moisture barrier bag.

The Moisture Sensitivity Level for each package type is specified in Ordering Information.

| CONDITION | MIN | MAX |
|---|------------|-------------|
| Supply voltages | -0.3V | +3.63V |
| Voltage range digital inputs | DGND -0.3V | DBVDD +0.3V |
| Voltage range analogue inputs | AGND -0.3V | AVDD +0.3V |
| Operating temperature range, T _A | -25°C | +85°C |
| Storage temperature after soldering | -65°C | +150°C |

Notes

1. Analogue and digital grounds must always be within 0.3V of each other.
2. All digital and analogue supplies are completely independent from each other.
3. DCVDD must be less than or equal to AVDD and DBVDD.

RECOMMENDED OPERATION CONDITIONS

| PARAMETER | SYMBOL | MIN | TYP | MAX | UNIT |
|-------------------------------|-------------------|------|-----|-----|------|
| Digital supply range (Core) | DCVDD | 1.42 | 2.0 | 3.6 | V |
| Digital supply range (Buffer) | DBVDD | 1.7 | 2.0 | 3.6 | V |
| Analogue supplies range | AVDD, HPVDD | 1.8 | 2.0 | 3.6 | V |
| Ground | DGND, AGND, HPGND | | 0 | | V |

ELECTRICAL CHARACTERISTICS

Test Conditions

DCVDD = 1.5V, DBVDD = 3.3V, AVDD = HPVDD = 3.3V, T_A = +25°C, 1kHz signal, f_s = 48kHz, PGA gain = 0dB, 24-bit audio data unless otherwise stated.

| PARAMETER | SYMBOL | TEST CONDITIONS | MIN | TYP | MAX | UNIT |
|--|------------|--|-----|--------------|-----|------------|
| Analogue Inputs (LINPUT1, RINPUT1, MIC) to ADC | | | | | | |
| Full Scale Input Signal Level (for ADC 0dB Input at 0dB Gain) | V_{INFS} | AVDD = 3.3V | | 1.0 | | V rms |
| | | AVDD = 1.8V | | 0.545 | | |
| Input Resistance | | L/RINPUT1 to ADC, PGA gain = 0dB | | 22 | | k Ω |
| | | L/RINPUT1 to ADC, PGA gain = +30dB | | 1.5 | | |
| | | L/RINPUT1 DC measurement | | 16 | | |
| | | L/RINPUT1 unused | | 17 | | |
| Input Capacitance | | | | 10 | | pF |
| Signal to Noise Ratio (A-weighted) | SNR | AVDD = 3.3V | 80 | 95 | | dB |
| | | AVDD = 1.8V | | 90 | | |
| Dynamic Range | | -60dBFS | 90 | 95 | | dB |
| Total Harmonic Distortion | THD | -1dBFS input, AVDD = 3.3V | | -82 0.008 | | dB % |
| | | -1dBFS input, AVDD = 1.8V | | -74 0.02 | | |
| ADC Channel Separation | | 1kHz signal | | 85 | | dB |
| Channel Matching | | 1kHz signal | | 0.2 | | dB |
| Analogue Outputs (LOUT1/2, ROUT1/2, MONOOUT) | | | | | | |
| 0dB Full scale output voltage | | | | AVDD/3.3 | | Vrms |
| Mute attenuation | | 1kHz, full scale signal | | 90 | | dB |
| | | MONOOUT pin | | 81 | | |
| Channel Separation | | analogue in to analogue out | | 85 | | dB |
| DAC to Line-Out (L/ROUT2 with 10kΩ / 50pF load) | | | | | | |
| Signal to Noise Ratio (A-weighted) | SNR | AVDD=3.3V | 90 | 98 | | dB |
| | | AVDD=1.8V | | 93 | | |
| Total Harmonic Distortion | THD | AVDD=3.3V | | -84 | | dB |
| | | AVDD=1.8V | | -80 | | |
| Channel Separation | | 1kHz signal | | 100 | | dB |
| Headphone Output (LOUT1/ROUT1, using capacitors) | | | | | | |
| Output Power per channel | P_O | Output power is very closely correlated with THD; see below. | | | | |
| Total Harmonic Distortion | THD | HPVDD=1.8V, $R_L=32\Omega$ $P_O=5mW$ | | 0.016 -76 | | % dB |
| | | HPVDD=1.8V, $R_L=16\Omega$ $P_O=5mW$ | | 0.022 -73 | | |
| | | HPVDD=3.3V, $R_L=32\Omega$, $P_O=20mW$ | | 0.013 -78 | | |
| | | HPVDD=3.3V, $R_L=16\Omega$, $P_O=20mW$ | | 0.018 -75 | | |
| Signal to Noise Ratio (A-weighted) | SNR | HPVDD = 3.3V | 92 | 96 | | dB |
| | | HPVDD = 1.8V | | 96 | | |

Test Conditions

DCVDD = 1.5V, DBVDD = 3.3V, AVDD = HPVDD = 3.3V, T_A = +25°C, 1kHz signal, f_s = 48kHz, PGA gain = 0dB, 24-bit audio data unless otherwise stated.

| PARAMETER | SYMBOL | TEST CONDITIONS | MIN | TYP | MAX | UNIT |
|--|----------------------|--|-----------|-------------|-----------|----------|
| Speaker Output (LOUT2/ROUT2 with 8Ω bridge tied load, ROUT2INV=1) | | | | | | |
| Output Power at 1% THD | P _O | THD = 1% | | 330 | | mW (rms) |
| Abs. Max Power Output | P _{Omax} | | | 500 | | mW (rms) |
| Total Harmonic Distortion | THD | P _O =200mW, R _L =8Ω, HPVDD=3.3V | | -63 0.07 | | dB % |
| Signal to Noise Ratio (A-weighted) | SNR | HPVDD=3.3V, R _L =8Ω | | 95 | | dB |
| Analogue Reference Levels | | | | | | |
| Midrail Reference Voltage | VMID | | -3% | AVDD/2 | +3% | V |
| Buffered Reference Voltage | VREF | | -3% | AVDD/2 | +3% | V |
| Microphone Bias | | | | | | |
| Bias Voltage | V _{MICBIAS} | 3mA load current | -5% | 0.9×AVDD | + 5% | V |
| Bias Current Source | I _{MICBIAS} | | | | 3 | mA |
| Output Noise Voltage | V _n | 1K to 20kHz | | 15 | | nV/√Hz |
| Digital Input / Output | | | | | | |
| Input HIGH Level | V _{IH} | | 0.7×DBVDD | | | V |
| Input LOW Level | V _{IL} | | | | 0.3×DBVDD | V |
| Output HIGH Level | V _{OH} | I _{OH} = +1mA | 0.9×DBVDD | | | V |
| Output LOW Level | V _{OL} | I _{OL} = -1mA | | | 0.1×DBVDD | V |
| HPDETECT (pin 23) | | | | | | |
| Input HIGH Level | V _{IH} | | 0.7×AVDD | | | V |
| Input LOW Level | V _{IL} | | | | 0.3×AVDD | V |

OUTPUT PGA'S LINEARITY

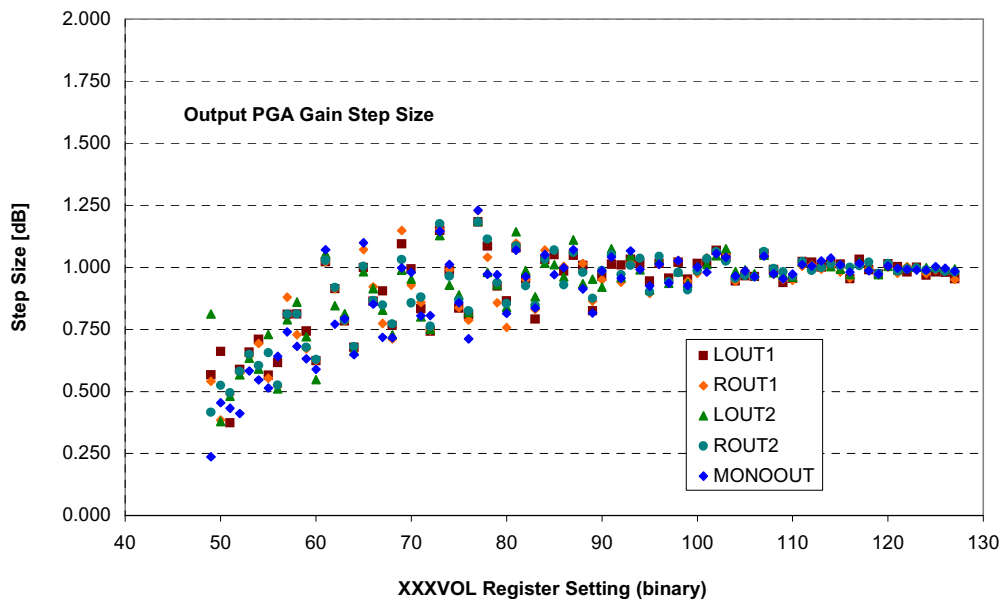
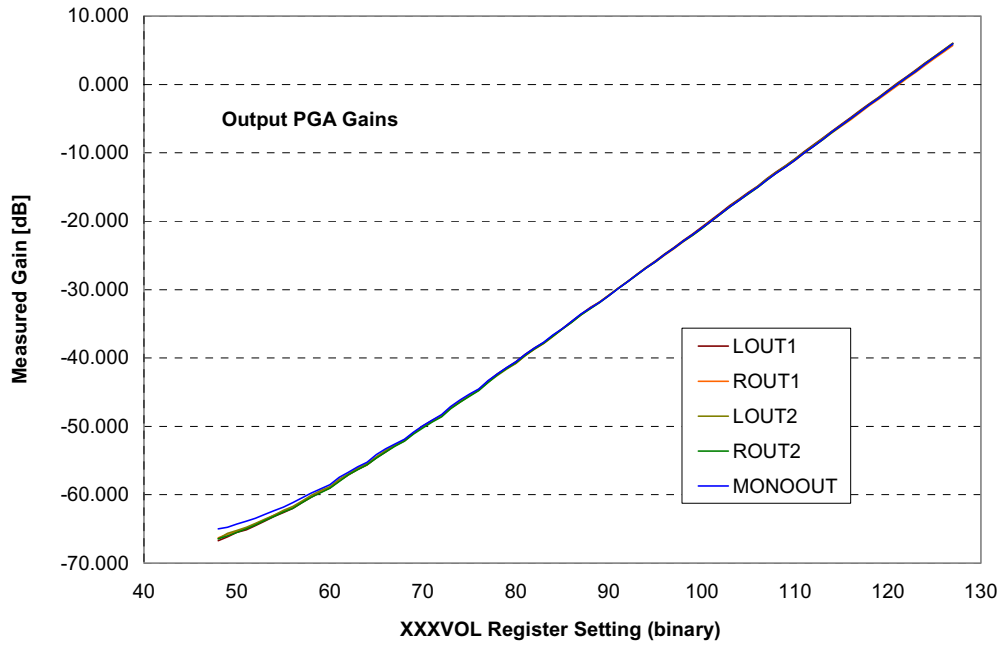

HEADPHONE OUTPUT THD VERSUS POWER

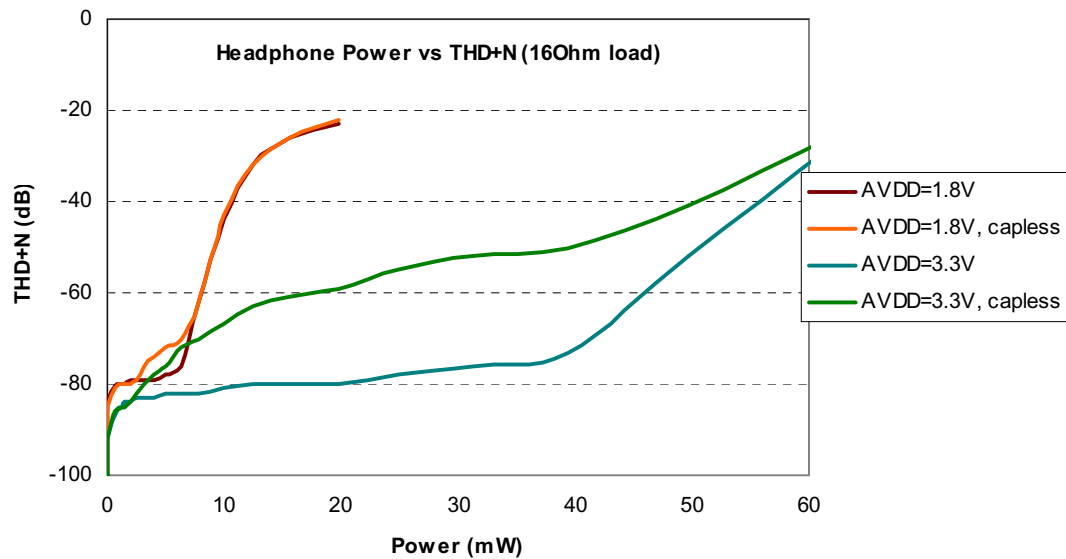
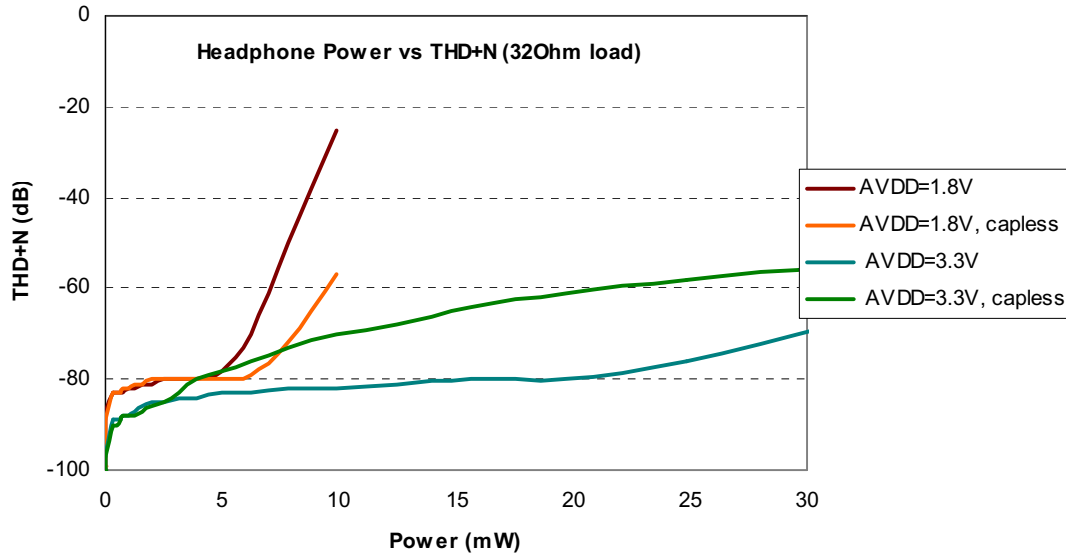

SPEAKER THD AND NOISE VERSUS POWER

THD referenced to 0.95Vrms

WM8971 L/ROUT2 8R BTL Speaker Load THD+NvPo

AVDD=HPVDD=DBVDD=3.3V DCVDD=1.42V
1.013kHz sinewave input signal, A-weighted

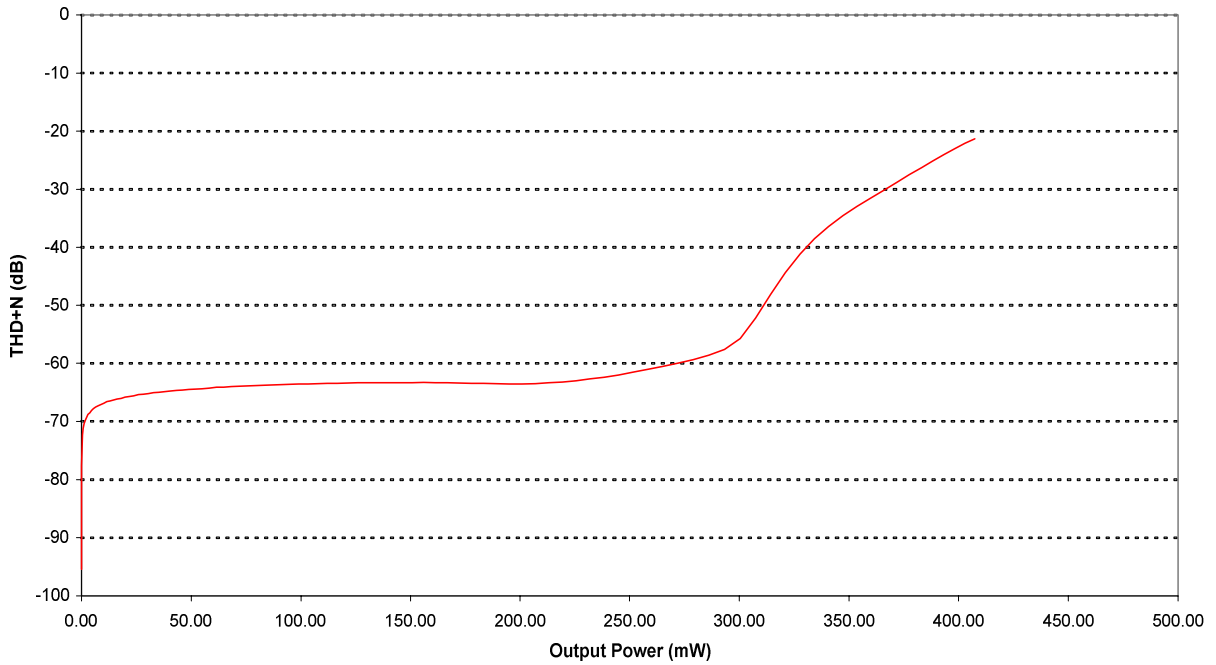

POWER CONSUMPTION

The power consumption of the WM8971L depends on the following factors.

- Supply voltages: Reducing the supply voltages also reduces supply currents, and therefore results in significant power savings, especially in the digital sections of the WM8971L.
- Operating mode: Significant power savings can be achieved by always disabling parts of the WM8971L that are not used (e.g. mic pre-amps, unused outputs, DAC, ADC, etc.)

| Control Register | R25 (19h) | | | | R26 (1Ah) | | | | R24 | R23 | Other settings | AVDD | | DCVDD | | DBVDD | | HPVDD | | Tot. Power | | | | | |
|--|-----------|---------|------|------|-----------|------|------|------|------|------|----------------|-------|-------|-------|-------|-------------------|------|--------|--------|------------|-----|--------|-----|--------|---------|
| | Bit | VMIDSEL | VREF | AINL | AINR | ADCL | ADCR | MICB | DACL | DACR | | LOUT1 | LOUT2 | MONO | ADCSR | DACOSR | VSEL | V | I (mA) | | V | I (mA) | V | I (mA) | V |
| OFF | 00 | 0 | 0 | 0 | 0 | 0 | 0 | 0 | 0 | 0 | 0 | 0 | 0 | 0 | 11 | Clocks stopped | 3.3 | 0.0016 | 3.3 | 0.0190 | 3.3 | 0.0080 | 3.3 | 0.0002 | 0.0950 |
| | | | | | | | | | | | | | | | | | 2.5 | 0.0008 | 2.5 | 0.0170 | 2.5 | 0.0050 | 2.5 | 0.0000 | 0.0570 |
| | | | | | | | | | | | | | | | | | 1.8 | 0.0005 | 1.5 | 0.0120 | 1.5 | 0.0029 | 1.8 | 0.0000 | 0.0233 |
| Standby (500 KOhm VMID string) | 10 | 1 | 0 | 0 | 0 | 0 | 0 | 0 | 0 | 0 | 0 | 0 | 0 | 0 | 11 | Interface Stopped | 3.3 | 0.3900 | 3.3 | 0.0390 | 3.3 | 0.0080 | 3.3 | 0.0000 | 1.4421 |
| | | | | | | | | | | | | | | | | | 2.5 | 0.2880 | 2.5 | 0.0170 | 2.5 | 0.0050 | 2.5 | 0.0000 | 0.7750 |
| | | | | | | | | | | | | | | | | | 1.8 | 0.1970 | 1.5 | 0.0120 | 1.5 | 0.0030 | 1.8 | 0.0000 | 0.3771 |
| Playback to Line-out | 01 | 1 | 0 | 0 | 0 | 0 | 0 | 1 | 1 | 0 | 0 | 1 | 1 | 0 | 11 | | 3.3 | 3.7310 | 3.3 | 5.6600 | 3.3 | 0.3000 | 3.3 | 0.2370 | 32.7624 |
| | | | | | | | | | | | | | | | | | 2.5 | 2.6940 | 2.5 | 3.8600 | 2.5 | 0.2200 | 2.5 | 0.2100 | 17.4600 |
| | | | | | | | | | | | | | | | | | 1.8 | 1.8820 | 1.5 | 2.1400 | 1.5 | 0.1240 | 1.8 | 0.1500 | 7.0536 |
| Playback to Line-out (64x oversampling mode) | 01 | 1 | 0 | 0 | 0 | 0 | 0 | 1 | 1 | 1 | 1 | 0 | 0 | 1 | 11 | | 3.3 | 3.5170 | 3.3 | 4.6470 | 3.3 | 0.3000 | 3.3 | 0.9500 | 31.0662 |
| | | | | | | | | | | | | | | | | | 2.5 | 2.5760 | 2.5 | 3.2030 | 2.5 | 0.2200 | 2.5 | 0.6480 | 16.6175 |
| | | | | | | | | | | | | | | | | | 1.8 | 1.7760 | 1.5 | 1.7590 | 1.5 | 0.1240 | 1.8 | 0.4130 | 6.7647 |
| Playback to 16 Ohm Headphone | 01 | 1 | 0 | 0 | 0 | 0 | 0 | 1 | 1 | 1 | 1 | 0 | 0 | 0 | 11 | | 3.3 | 3.7260 | 3.3 | 5.6700 | 3.3 | 0.3000 | 3.3 | 0.9530 | 35.1417 |
| | | | | | | | | | | | | | | | | | 2.5 | 2.7530 | 2.5 | 3.9250 | 2.5 | 0.2200 | 2.5 | 0.6570 | 18.8875 |
| | | | | | | | | | | | | | | | | | 1.8 | 1.8900 | 1.5 | 2.1410 | 1.5 | 0.1240 | 1.8 | 0.4150 | 7.5465 |
| Playback to 8 Ohm BTL Speaker | 01 | 1 | 0 | 0 | 0 | 0 | 0 | 1 | 1 | 0 | 0 | 1 | 1 | 0 | 11 | R24, ROUT2INV=1 | 3.3 | 3.8820 | 3.3 | 5.6470 | 3.3 | 0.3000 | 3.3 | 0.2830 | 33.3696 |
| | | | | | | | | | | | | | | | | | 2.5 | 2.8780 | 2.5 | 3.9390 | 2.5 | 0.2200 | 2.5 | 0.2100 | 18.1175 |
| | | | | | | | | | | | | | | | | | 1.8 | 1.9800 | 1.5 | 2.1630 | 1.5 | 0.1240 | 1.8 | 0.1510 | 7.2663 |
| Headphone Amp (line-in to 16 Ohm headphone) | 01 | 1 | 0 | 0 | 0 | 0 | 0 | 0 | 0 | 1 | 1 | 0 | 0 | 0 | 11 | Clocks Stopped | 3.3 | 1.8400 | 3.3 | 0.0200 | 3.3 | 0.0080 | 3.3 | 0.9540 | 9.3126 |
| | | | | | | | | | | | | | | | | | 2.5 | 1.3300 | 2.5 | 0.0190 | 2.5 | 0.0050 | 2.5 | 0.6400 | 4.9850 |
| | | | | | | | | | | | | | | | | | 1.8 | 0.9300 | 1.5 | 0.0130 | 1.5 | 0.0030 | 1.8 | 0.4100 | 2.4360 |
| Speaker Amp (line-in to 8 Ohm speaker) | 01 | 1 | 0 | 0 | 0 | 0 | 0 | 0 | 0 | 0 | 1 | 1 | 0 | 0 | 11 | Clocks Stopped | 3.3 | 1.9780 | 3.3 | 0.0200 | 3.3 | 0.0080 | 3.3 | 0.3310 | 7.7121 |
| | | | | | | | | | | | | | | | | | 2.5 | 1.4300 | 2.5 | 0.0190 | 2.5 | 0.0050 | 2.5 | 0.2430 | 4.2425 |
| | | | | | | | | | | | | | | | | | 1.8 | 0.9860 | 1.5 | 0.0130 | 1.5 | 0.0030 | 1.8 | 0.1760 | 2.1156 |
| Phone Call (mono line-in to headphone, mic to MONOOUT) | 01 | 1 | 0 | 0 | 0 | 0 | 0 | 0 | 0 | 1 | 1 | 1 | 0 | 0 | 11 | Clocks Stopped | 3.3 | 2.5230 | 3.3 | 0.0370 | 3.3 | 0.0080 | 3.3 | 0.4420 | 9.9330 |
| | | | | | | | | | | | | | | | | | 2.5 | 1.8520 | 2.5 | 0.0190 | 2.5 | 0.0050 | 2.5 | 0.3200 | 5.4900 |
| | | | | | | | | | | | | | | | | | 1.8 | 1.2900 | 1.5 | 0.0130 | 1.5 | 0.0030 | 1.8 | 0.2240 | 2.7492 |
| Record from Line-in | 01 | 1 | 1 | 1 | 1 | 1 | 0 | 0 | 0 | 0 | 0 | 0 | 0 | 0 | 11 | | 3.3 | 8.6600 | 3.3 | 6.5700 | 3.3 | 0.3330 | 3.3 | 0.0000 | 51.3579 |
| | | | | | | | | | | | | | | | | | 2.5 | 7.7100 | 2.5 | 4.2800 | 2.5 | 0.2320 | 2.5 | 0.0000 | 30.5550 |
| | | | | | | | | | | | | | | | | | 1.8 | 6.8000 | 1.5 | 2.2100 | 1.5 | 0.1350 | 1.8 | 0.0000 | 15.7575 |
| Record from Line-in (64x oversampling mode) | 01 | 1 | 1 | 1 | 1 | 1 | 0 | 0 | 0 | 0 | 0 | 0 | 0 | 1 | 11 | | 3.3 | 5.0720 | 3.3 | 5.9100 | 3.3 | 0.3390 | 3.3 | 0.0000 | 37.3593 |
| | | | | | | | | | | | | | | | | | 2.5 | 4.2550 | 2.5 | 3.7500 | 2.5 | 0.2320 | 2.5 | 0.0000 | 20.5925 |
| | | | | | | | | | | | | | | | | | 1.8 | 3.5900 | 1.5 | 1.9100 | 1.5 | 0.1350 | 1.8 | 0.0000 | 9.5295 |
| Record from mono microphone | 01 | 1 | 1 | 0 | 1 | 0 | 1 | 0 | 0 | 0 | 0 | 0 | 0 | 0 | 11 | R23, DATSEL=01 | 3.3 | 4.9330 | 3.3 | 6.5400 | 3.3 | 0.3390 | 3.3 | 0.0000 | 38.9796 |
| | | | | | | | | | | | | | | | | | 2.5 | 4.2970 | 2.5 | 4.2500 | 2.5 | 0.2400 | 2.5 | 0.0000 | 21.9675 |
| | | | | | | | | | | | | | | | | | 1.8 | 3.7210 | 1.5 | 2.2200 | 1.5 | 0.1370 | 1.8 | 0.0000 | 10.2333 |
| Stereo Record & Playback | 01 | 1 | 1 | 1 | 1 | 1 | 1 | 1 | 1 | 0 | 0 | 1 | 1 | 0 | 11 | | 3.3 | 11.927 | 3.3 | 10.870 | 3.3 | 0.3320 | 3.3 | 0.2820 | 77.2563 |
| | | | | | | | | | | | | | | | | | 2.5 | 10.112 | 2.5 | 7.3600 | 2.5 | 0.2340 | 2.5 | 0.2060 | 44.7800 |
| | | | | | | | | | | | | | | | | | 1.8 | 7.3910 | 1.5 | 4.0610 | 1.5 | 0.1320 | 1.8 | 0.1480 | 19.8597 |
| Stereo Record & Playback (64x oversampling mode) | 01 | 1 | 1 | 1 | 1 | 1 | 1 | 1 | 1 | 0 | 0 | 1 | 1 | 1 | 11 | | 3.3 | 8.1090 | 3.3 | 9.3300 | 3.3 | 0.3330 | 3.3 | 0.2820 | 59.5782 |
| | | | | | | | | | | | | | | | | | 2.5 | 6.5500 | 2.5 | 6.3020 | 2.5 | 0.2340 | 2.5 | 0.2070 | 33.2325 |
| | | | | | | | | | | | | | | | | | 1.8 | 4.7000 | 1.5 | 3.3800 | 1.5 | 0.1320 | 1.8 | 0.1490 | 13.9962 |

Table 1 Supply Current Consumption

Notes:

1. All figures are at T_A = +25°C, Slave Mode, fs = 48kHz, MCLK = 12.288 MHz (256fs), with zero signal (quiescent)
2. The power dissipated in the headphone or speaker is not included in the above table.

SIGNAL TIMING REQUIREMENTS

SYSTEM CLOCK TIMING

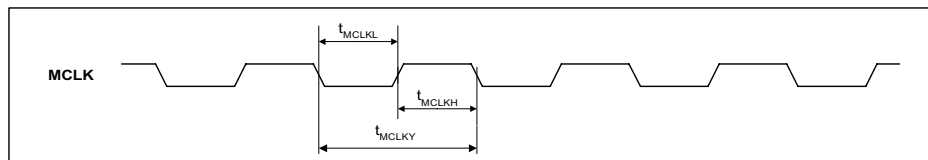

Figure 1 System Clock Timing Requirements

Test Conditions

CLKDIV2=0, DCVDD = 1.42V, DBVDD = 3.3V, DGND = 0V, T_A = +25°C, Slave Mode fs = 48kHz, MCLK = 384fs, 24-bit data, unless otherwise stated.

| PARAMETER | SYMBOL | MIN | TYP | MAX | UNIT |
|--|---------------------|-------|-----|-------|------|
| System Clock Timing Information | | | | | |
| MCLK System clock pulse width high | T _{MCLKL} | 21 | | | ns |
| MCLK System clock pulse width low | T _{MCLKH} | 21 | | | ns |
| MCLK System clock cycle time | T _{MCLKY} | 54 | | | ns |
| MCLK duty cycle | T _{MCLKDS} | 60:40 | | 40:60 | |

Test Conditions

CLKDIV2=1, DCVDD = 1.42V, DBVDD = 3.3V, DGND = 0V, T_A = +25°C, Slave Mode fs = 48kHz, MCLK = 384fs, 24-bit data, unless otherwise stated.

| PARAMETER | SYMBOL | MIN | TYP | MAX | UNIT |
|--|--------------------|-----|-----|-----|------|
| System Clock Timing Information | | | | | |
| MCLK System clock pulse width high | T _{MCLKL} | 10 | | | ns |
| MCLK System clock pulse width low | T _{MCLKH} | 10 | | | ns |
| MCLK System clock cycle time | T _{MCLKY} | 27 | | | ns |

AUDIO INTERFACE TIMING – MASTER MODE

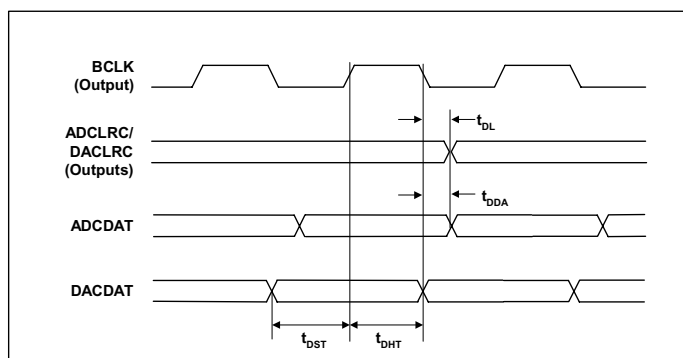

Figure 2 Digital Audio Data Timing – Master Mode (see Control Interface)

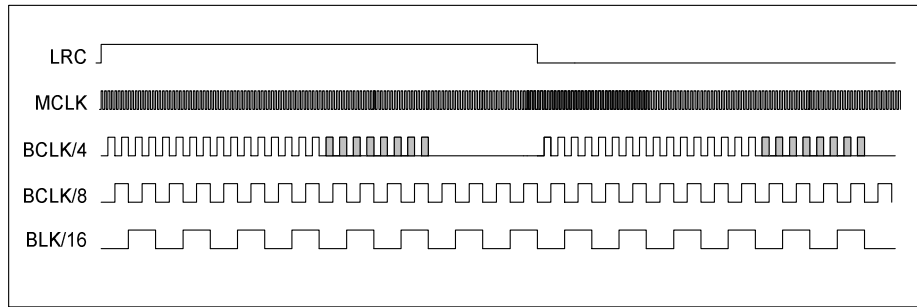

Figure 3 Bit Clock Mode

Test Conditions

DCVDD = 1.42V, DBVDD = 3.3V, DGND = 0V, T_A = +25°C, Slave Mode, fs = 48kHz, MCLK = 256fs, 24-bit data, unless otherwise stated.

| PARAMETER | SYMBOL | MIN | TYP | MAX | UNIT |
|--|---------------------|-----|---------------------|-----|------|
| Bit Clock Timing Information | | | | | |
| BCLK rise time (10pF load) | t _{BCLKR} | | | 3 | ns |
| BCLK fall time (10pF load) | t _{BCLKF} | | | 3 | ns |
| BCLK duty cycle (normal mode, BCLK = MCLK/n) | t _{BCLKDS} | | 50:50 | | |
| BCLK duty cycle (USB mode, BCLK = MCLK) | t _{BCLKDS} | | T _{MCLKDS} | | |
| Audio Data Input Timing Information | | | | | |
| ADCLRC/DACLRC propagation delay from BCLK falling edge | t _{DL} | | | 10 | ns |
| ADCDAT propagation delay from BCLK falling edge | t _{DDA} | | | 10 | ns |
| DACDAT setup time to BCLK rising edge | t _{DST} | 10 | | | ns |
| DACDAT hold time from BCLK rising edge | t _{DHT} | 10 | | | ns |

AUDIO INTERFACE TIMING – SLAVE MODE

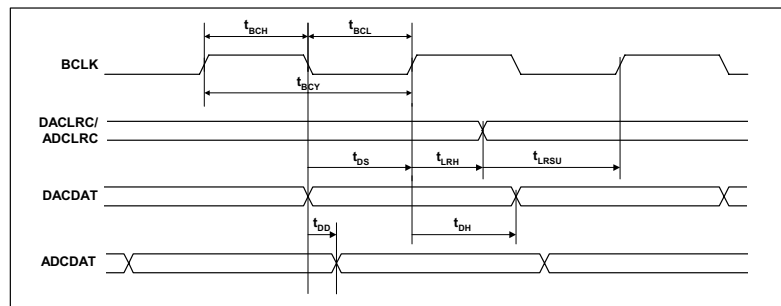

Figure 4 Digital Audio Data Timing – Slave Mode

Test Conditions

DCVDD = 1.42V, DBVDD = 3.3V, DGND = 0V, T_A = +25°C, Slave Mode, fs = 48kHz, MCLK = 256fs, 24-bit data, unless otherwise stated.

| PARAMETER | SYMBOL | MIN | TYP | MAX | UNIT |
|---|-------------------|-----|-----|-----|------|
| Audio Data Input Timing Information | | | | | |
| BCLK cycle time | t _{BCY} | 50 | | | ns |
| BCLK pulse width high | t _{BCH} | 20 | | | ns |
| BCLK pulse width low | t _{BCL} | 20 | | | ns |
| ADCLRC/DACLRC set-up time to BCLK rising edge | t _{LRSU} | 10 | | | ns |
| ADCLRC/DACLRC hold time from BCLK rising edge | t _{LRH} | 10 | | | ns |
| DACDAT hold time from BCLK rising edge | t _{DH} | 10 | | | ns |
| ADCDAT propagation delay from BCLK falling edge | t _{DD} | | | 10 | ns |

Note:

BCLK period should always be greater than or equal to MCLK period.

CONTROL INTERFACE TIMING – 3-WIRE MODE

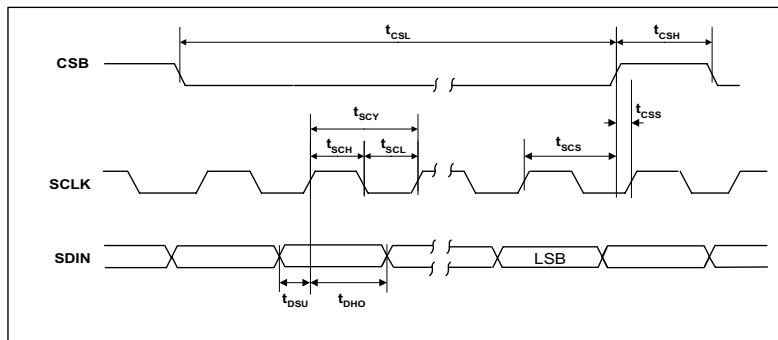

Figure 5 Control Interface Timing – 3-Wire Serial Control Mode

Test Conditions

DCVDD = 1.42V, DBVDD = 3.3V, DGND = 0V, T_A = +25°C, Slave Mode, fs = 48kHz, MCLK = 256fs, 24-bit data, unless otherwise stated.

| PARAMETER | SYMBOL | MIN | TYP | MAX | UNIT |
|---|-----------|-----|-----|-----|------|
| Program Register Input Information | | | | | |
| SCLK rising edge to CSB rising edge | t_{SCS} | 80 | | | ns |
| SCLK pulse cycle time | t_{SCY} | 200 | | | ns |
| SCLK pulse width low | t_{SCL} | 80 | | | ns |
| SCLK pulse width high | t_{SCH} | 80 | | | ns |
| SDIN to SCLK set-up time | t_{DSU} | 40 | | | ns |
| SCLK to SDIN hold time | t_{DHO} | 40 | | | ns |
| CSB pulse width low | t_{CSL} | 40 | | | ns |
| CSB pulse width high | t_{CSH} | 40 | | | ns |
| CSB rising to SCLK rising | t_{CSS} | 40 | | | ns |
| Pulse width of spikes that will be suppressed | t_{PS} | 0 | | 5 | ns |

CONTROL INTERFACE TIMING – 2-WIRE MODE

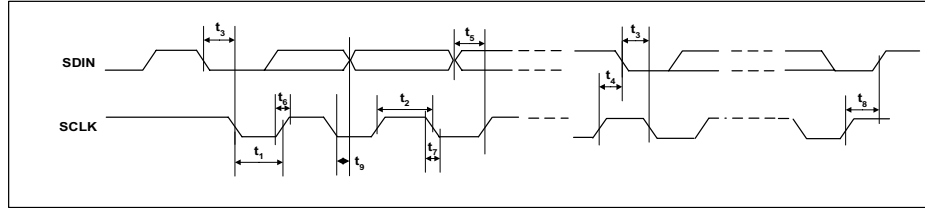

Figure 6 Control Interface Timing – 2-Wire Serial Control Mode

Test Conditions

DCVDD = 1.42V, DBVDD = 3.3V, DGND = 0V, T_A = +25°C, Slave Mode, f_s = 48kHz, MCLK = 256fs, 24-bit data, unless otherwise stated.

| PARAMETER | SYMBOL | MIN | TYP | MAX | UNIT |
|---|----------|-----|-----|-----|------|
| Program Register Input Information | | | | | |
| SCLK Frequency | | 0 | | 400 | kHz |
| SCLK Low Pulse-Width | t_1 | 1.3 | | | us |
| SCLK High Pulse-Width | t_2 | 600 | | | ns |
| Hold Time (Start Condition) | t_3 | 600 | | | ns |
| Setup Time (Start Condition) | t_4 | 600 | | | ns |
| Data Setup Time | t_5 | 100 | | | ns |
| SDIN, SCLK Rise Time | t_6 | | | 300 | ns |
| SDIN, SCLK Fall Time | t_7 | | | 300 | ns |
| Setup Time (Stop Condition) | t_8 | 600 | | | ns |
| Data Hold Time | t_9 | | | 900 | ns |
| Pulse width of spikes that will be suppressed | t_{ps} | 0 | | 5 | ns |

INTERNAL POWER ON RESET CIRCUIT

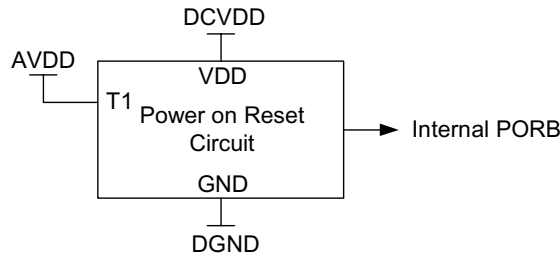

Figure 7 Internal Power on Reset Circuit Schematic

The WM8971 includes an internal Power-On-Reset Circuit, as shown in Figure 7, which is used to reset the digital logic into a default state after power up. The power on reset circuit is powered from DCVDD and monitors DCVDD and AVDD. It asserts PORB low if DCVDD or AVDD are below a minimum threshold.

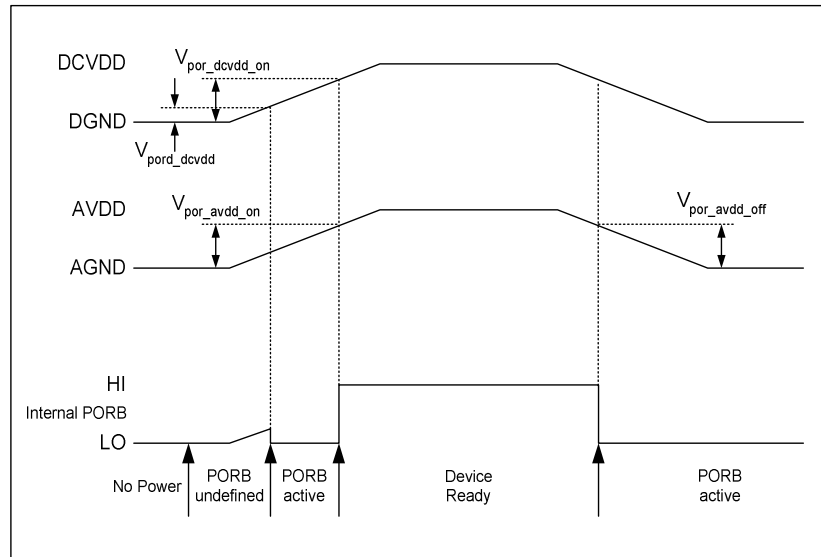

Figure 8 Typical Power-Up Sequence

Figure 8 shows a typical power-up sequence. When DCVDD and AVDD go above the minimum thresholds, V_{por_dcavdd} and V_{por_avdd} , there is enough voltage for the circuit to guarantee the Power on Reset is asserted low and the chip is held in reset. In this condition, all writes to the control interface are ignored. When DCVDD rises to $V_{por_dcavdd_on}$ and AVDD rises to $V_{por_avdd_on}$, PORB is released high and all registers are in their default state and writes to the control interface may take place. If DCVDD and AVDD rise at different rates then PORB will only be released when DCVDD and AVDD have both exceeded the $V_{por_dcavdd_on}$ and $V_{por_avdd_on}$ thresholds.

On power down, PORB is asserted low whenever DCVDD drops below the minimum threshold $V_{por_dcavdd_off}$ or AVDD drops below the minimum threshold $V_{por_avdd_off}$.

| SYMBOL | MIN | TYP | MAX | UNIT |
|-----------------------|-----|------|-----|------|
| V_{por_dcavdd} | 0.4 | 0.6 | 0.8 | V |
| $V_{por_dcavdd_on}$ | 0.9 | 1.26 | 1.6 | V |
| $V_{por_avdd_on}$ | 0.5 | 0.7 | 0.9 | V |
| $V_{por_avdd_off}$ | 0.4 | 0.6 | 0.8 | V |

Table 2 Typical POR Operation (typical values, not tested)

DEVICE DESCRIPTION

INTRODUCTION

The WM8971L is a low power audio codec offering a combination of high quality audio, advanced features, low power and small size. These characteristics make it ideal for portable digital audio applications such as Digital Still Cameras, MP3 and minidisk player / recorders. Stereo 24-bit multi-bit delta sigma ADCs and DACs are used with oversampling digital interpolation and decimation filters.

The device includes a stereo analogue input which can be switched internally. This input can be used as either a line level input, as a microphone input or be selected as a mono differential input. A mono input is also included which can be configured as a microphone or line input.

When recording a programmable gain amplifier with automatic level control (ALC) keeps the recording volume constant. The on-chip stereo ADC and DAC are of a high quality using a multi-bit, low-order oversampling architecture to deliver optimum performance with low power consumption.

The DAC output signal first enters an analogue mixer where an analogue input and/or the post-ALC signal can be added to it. This mix is available on line and headphone outputs.

The WM8971L has a configurable digital audio interface where ADC data can be read and digital audio playback data fed to the DAC. It supports a number of audio data formats including I²S, DSP Mode (a burst mode in which frame sync plus 2 data packed words are transmitted), MSB-First, left justified and MSB-First, right justified, and can operate in master or slave modes.

The WM8971L uses a unique clocking scheme that can generate many commonly used audio sample rates from either a 12.00MHz USB clock or an industry standard 256/384 f_s clock. This feature eliminates the common requirement for an external phase-locked loop (PLL) in applications where the master clock is not an integer multiple of the sample rate. Sample rates of 8kHz, 11.025kHz, 12kHz, 16kHz, 22.05kHz, 24kHz, 32kHz, 44.1kHz, 48kHz, 88.2kHz and 96kHz can be generated. The digital filters used for recording and playback are optimised for each sampling rate used.

To allow full software control over all its features, the WM8971L offers a choice of 2 or 3 wire MPU control interface. It is fully compatible and an ideal partner for a wide range of industry standard microprocessors, controllers and DSPs.

The design of the WM8971L has given much attention to power consumption without compromising performance. It operates at very low voltages, and includes the ability to power off parts of the circuitry under software control, including standby and power off modes.

INPUT SIGNAL PATH

The input signal path for each channel consists of a switch to select between three analogue inputs, followed by a PGA (programmable gain amplifier) and an optional microphone gain boost. A differential input of (LINPUT1 – RINPUT1) may also be selected. The gain of the PGA can be controlled either by the user or by the on-chip ALC function (see Automatic Level Control).

The signal then enters an ADC where it is digitised. Alternatively, the two channels can also be mixed in the analogue domain and digitised in one ADC while the other ADC is switched off. The mono-mix signal appears on both digital output channels.

SIGNAL INPUTS

The WM8971L has three high impedance, low capacitance AC coupled analogue inputs, LINPUT1, RINPUT1, and MIC. The LINSEL and RINSEL control bits select between them. These inputs can be configured as microphone or line inputs by enabling or disabling the microphone gain boost. A differential input, LINPUT1-RINPUT1 may also be selected using L/RINSEL.

The signal inputs are biased internally to the reference voltage VREF. Whenever the line inputs are muted or the device placed into standby mode, the inputs are kept biased to VREF using special anti-thump circuitry. This reduces any audible clicks that may otherwise be heard when changing inputs.

| REGISTER ADDRESS | BIT | LABEL | DEFAULT | DESCRIPTION |
|--|-----|-----------|---------|---|
| R32 (20h) ADC Signal Path Control (Left) | 7:6 | LINSEL | 00 | Left Channel Input Select 00 = LINPUT1 11 = Differential |
| | 5:4 | LMICBOOST | 00 | Left Channel Microphone Gain Boost 00 = Boost off (bypassed) 01 = 13dB boost 10 = 20dB boost 11 = 29dB boost |
| R33 (21h) ADC Signal Path Control (Right) | 7:6 | RINSEL | 00 | Right Channel Input Select 00 = RINPUT1 01 = MIC 11 = Differential |
| | 5:4 | RMICBOOST | 00 | Right Channel Microphone Gain Boost 00 = Boost off (bypassed) 01 = 13dB boost 10 = 20dB boost 11 = 29dB boost |

Table 3 Input Software Control

MONO MIXING

The stereo ADC can operate as a stereo or mono device, or the two channels can be mixed to mono, either in the analogue domain (i.e. before the ADC) or in the digital domain (after the ADC). MONOMIX selects the mode of operation. The user also has the flexibility to select the data output from the audio interface using DATSEL. The default is for left and right channel ADC data to be output, but the interface may also be configured so that e.g. left channel ADC data is output as both left and right data for when an analogue mono mix is selected.

| REGISTER ADDRESS | BIT | LABEL | DEFAULT | DESCRIPTION |
|-----------------------------|-----|---------------|---------|---|
| R31 (1Fh) ADC input Mode | 7:6 | MONOMIX [1:0] | 00 | 00: Stereo 01: Analogue Mono Mix (using left ADC) 10: Analogue Mono Mix (using right ADC) 11: Digital Mono Mix |

Table 4 Mono Mixing

| REGISTER ADDRESS | BIT | LABEL | DEFAULT | DESCRIPTION |
|-------------------------------------|-----|--------------|---------|---|
| R23 (17h) Additional Control (1) | 3:2 | DATSEL [1:0] | 00 | 00: left data=left ADC; right data =right ADC 01: left data =left ADC; right data = left ADC 10: left data = right ADC; right data =right ADC 11: left data = right ADC; right data = left ADC |

Table 5 ADC Data Output Configuration

The MICBIAS output provides a low noise reference voltage suitable for biasing electret type microphones and the associated external resistor biasing network. Refer to the Applications Information section for recommended external components. The output can be enabled or disabled using the MICB control bit (see also the “Power Management” section).

| REGISTER ADDRESS | BIT | LABEL | DEFAULT | DESCRIPTION |
|-----------------------------------|-----|-------|---------|---|
| R25 (19h) Power Management (1) | 1 | MICB | 0 | Microphone Bias Enable 0 = OFF (high impedance output) 1 = ON |

Table 6 Microphone Bias Control

The internal MICBIAS circuitry is shown below. Note that the maximum source current capability for MICBIAS is 3mA. The external biasing resistors therefore must be large enough to limit the MICBIAS current to 3mA.

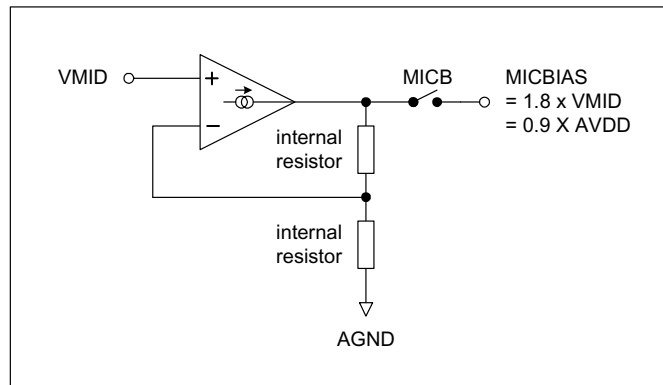

Figure 9 Microphone Bias Schematic

PGA CONTROL

The PGA matches the input signal level to the ADC input range. The PGA gain is logarithmically adjustable from +30dB to -17.25dB in 0.75dB steps. Each PGA can be controlled either by the user or by the ALC function (see Automatic Level Control). When ALC is enabled for one or both channels, then writing to the corresponding PGA control register has no effect.

The gain is independently adjustable on both Right and Left Line Inputs. However, by setting the LIVU or RIVU bits whilst programming the PGA gain, both channels are simultaneously updated. This reduces the required number of software writes required. Setting the LZCEN and RZCEN bits enables a zero-cross detector which ensures that PGA gain changes only occur when the signal is at zero, eliminating any zipper noise. If zero cross is enabled a timeout is also available to update the gain if a zero cross does not occur. This function may be enabled by setting TOEN in register R23 (17h).

The inputs can also be muted in the analogue domain under software control. The software control registers are shown in Table 7. If zero crossing is enabled, it is necessary to enable zero cross timeout to un-mute the input PGAs. This is because their outputs will not cross zero when muted. Alternatively, zero cross can be disabled before sending the un-mute command.

| REGISTER ADDRESS | BIT | LABEL | DEFAULT | DESCRIPTION |
|--|-----|-----------------|-------------------|---|
| R0 (00h) Left Channel PGA | 8 | LIVU | 0 | Left Volume Update 0 = Store LINVOL in intermediate latch (no gain change) 1 = Update left and right channel gains (left = LINVOL, right = intermediate latch) |
| | 7 | LINMUTE | 1 | Left Channel Input Analogue Mute 1 = Enable Mute 0 = Disable Mute Note: LIVU must be set to un-mute. |
| | 6 | LZCEN | 0 | Left Channel Zero Cross Detector 1 = Change gain on zero cross only 0 = Change gain immediately |
| | 5:0 | LINVOL [5:0] | 010111 (0dB) | Left Channel Input Volume Control 111111 = +30dB 111110 = +29.25dB .. 0.75dB steps down to 000000 = -17.25dB |
| R1 (01h) Right Channel PGA | 8 | RIVU | 0 | Right Volume Update 0 = Store RINVOL in intermediate latch (no gain change) 1 = Update left and right channel gains (right = RINVOL, left = intermediate latch) |
| | 7 | RINMUTE | 1 | Right Channel Input Analogue Mute 1 = Enable Mute 0 = Disable Mute Note: RIVU must be set to un-mute. |
| | 6 | RZCEN | 0 | Right Channel Zero Cross Detector 1 = Change gain on zero cross only 0 = Change gain immediately |
| | 5:0 | RINVOL [5:0] | 010111 (0dB) | Right Channel Input Volume Control 111111 = +30dB 111110 = +29.25dB .. 0.75dB steps down to 000000 = -17.25dB |
| R23 (17h) Additional Control (1) | 0 | TOEN | 0 | Timeout Enable 0 : Timeout Disabled 1 : Timeout Enabled |

Table 7 Input PGA Software Control

ANALOGUE TO DIGITAL CONVERTER (ADC)

The WM8971L uses a multi-bit, oversampled sigma-delta ADC for each channel. The use of multi-bit feedback and high oversampling rates reduces the effects of jitter and high frequency noise. The ADC Full Scale input level is proportional to AVDD. With a 3.3V supply voltage, the full scale level is 1.0 Volts r.m.s. Any voltage greater than full scale may overload the ADC and cause distortion.

ADC DIGITAL FILTER

The ADC filters perform true 24 bit signal processing to convert the raw multi-bit oversampled data from the ADC to the correct sampling frequency to be output on the digital audio interface. The digital filter path is illustrated in Figure 10.

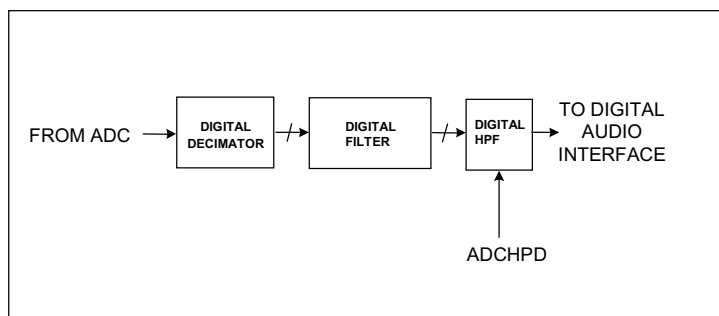

Figure 10 ADC Digital Filter

The ADC digital filters contain a digital high pass filter, selectable via software control. The high-pass filter response is detailed in the Digital Filter Characteristics section. When the high-pass filter is enabled the dc offset is continuously calculated and subtracted from the input signal. By setting HPOR, the last calculated dc offset value is stored when the high-pass filter is disabled and will continue to be subtracted from the input signal. If the DC offset is changed, the stored and subtracted value will not change unless the high-pass filter is enabled. This feature can be used for calibration purposes. In addition the high-pass filter may be enabled separately on the left and right channels (see Table 9).

The output data format can be programmed by the user to accommodate stereo or monophonic recording on both inputs. The polarity of the output signal can also be changed under software control. The software control is shown in Table 8.

| REGISTER ADDRESS | BIT | LABEL | DEFAULT | DESCRIPTION |
|------------------------------------|-----|-----------------|---------|---|
| R5 (05h) ADC and DAC Control | 6:5 | ADCPOL [1:0] | 00 | 00 = Polarity not inverted 01 = L polarity invert 10 = R polarity invert 11 = L and R polarity invert |
| | 4 | HPOR | 0 | Store dc offset when high-pass Filter disabled 1 = store offset 0 = clear offset |
| | 0 | ADCHPD | 0 | ADC high-pass filter enable (Digital) HPFLREN = 0 1 = Disable High-pass filter on left and right channels 0 = Enable High-pass filter on left and right channels HPFLREN = 1 0 = High-pass enabled on left, disabled on right 1 = High-pass enabled on right, disabled on left |
| R27 (1Bh) | 5 | HPFLREN | 0 | ADC high-pass filter left or right enable 0 = High-pass filter enable/disable on left and right channels controlled by ADCHPD 1 = High-pass filter enabled on left or right channel, as selected by ADCHPD |

Table 8 ADC Signal Path Control

| HPFLREN | ADCHPD | HIGH PASS MODE |
|---------|--------|--|
| 0 | 0 | High-pass filter enabled on left and right channels |
| 0 | 1 | High-pass filter disabled on left and right channels |
| 1 | 0 | High-pass filter enabled on left channel, disabled on right channel |
| 1 | 1 | High-pass filter disabled on left channel, enabled on right channel |

Table 9 ADC High Pass Filter Enable Modes

DIGITAL ADC VOLUME CONTROL

The output of the ADCs can be digitally amplified or attenuated over a range from -97dB to +30dB in 0.5dB steps. The volume of each channel can be controlled separately. The gain for a given eight-bit code X is given by:

$$0.5 \times (X-195) \text{ dB for } 1 \leq X \leq 255; \quad \text{MUTE for } X = 0$$

The LAVU and RAVU control bits control the loading of digital volume control data. When LAVU or RAVU are set to 0, the LADCVOL or RADCVOL control data will be loaded into the respective control register, but will not actually change the digital gain setting. Both left and right gain settings are updated when either LAVU or RAVU are set to 1. This makes it possible to update the gain of both channels simultaneously.

| REGISTER ADDRESS | BIT | LABEL | DEFAULT | DESCRIPTION |
|--|-----|------------------|---------------------|---|
| R21 (15h) Left ADC Digital Volume | 7:0 | LADCVOL [7:0] | 11000011 (0dB) | Left ADC Digital Volume Control 0000 0000 = Digital Mute 0000 0001 = -97dB 0000 0010 = -96.5dB ... 0.5dB steps up to 1111 1111 = +30dB |
| | 8 | LAVU | 0 | Left ADC Volume Update 0 = Store LADCVOL in intermediate latch (no gain change) 1 = Update left and right channel gains (left = LADCVOL, right = intermediate latch) |
| R22 (16h) Right ADC Digital Volume | 7:0 | RADCVOL [7:0] | 11000011 (0dB) | Right ADC Digital Volume Control 0000 0000 = Digital Mute 0000 0001 = -97dB 0000 0010 = -96.5dB ... 0.5dB steps up to 1111 1111 = +30dB |
| | 8 | RAVU | 0 | Right ADC Volume Update 0 = Store RADCVOL in intermediate latch (no gain change) 1 = Update left and right channel gains (left = intermediate latch, right = RADCVOL) |

Table 10 ADC Digital Volume Control

AUTOMATIC LEVEL CONTROL (ALC)

The WM8971L has an automatic level control that aims to keep a constant recording volume irrespective of the input signal level. This is achieved by continuously adjusting the PGA gain so that the signal level at the ADC input remains constant. A digital peak detector monitors the ADC output and changes the PGA gain if necessary. Note that when the ALC function is enabled, the settings of registers 0 and 1 (LINVOL, LIVU, LIZC, LINMUTE, RINVOL, RIVU, RIZC and RINMUTE) are ignored.

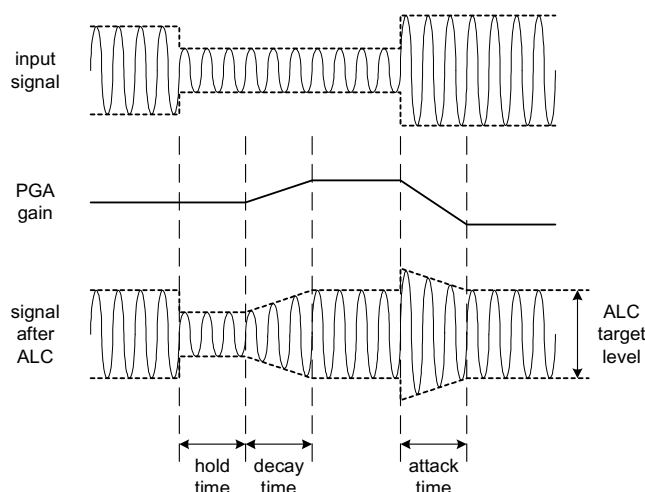

Figure 11 ALC Operation

The ALC function is enabled using the ALCSEL control bits. When enabled, the recording volume can be programmed between -6dB and -28.5dB (relative to ADC full scale) using the ALCL register bits. An upper limit for the PGA gain can be imposed by setting the MAXGAIN control bits.

HLD, DCY and ATK control the hold, decay and attack times, respectively:

Hold time is the time delay between the peak level detected being below target and the PGA gain beginning to ramp up. It can be programmed in power-of-two (2^n) steps, e.g. 2.67ms, 5.33ms, 10.67ms etc. up to 43.7s. Alternatively, the hold time can also be set to zero. The hold time only applies to gain ramp-up, there is no delay before ramping the gain down when the signal level is above target.

Decay (Gain Ramp-Up) Time is the time that it takes for the PGA gain to ramp up across 90% of its range (e.g. from -15B up to 27.75dB). The time it takes for the recording level to return to its target value therefore depends on both the decay time and on the gain adjustment required. If the gain adjustment is small, it will be shorter than the decay time. The decay time can be programmed in power-of-two (2^n) steps, from 24ms, 48ms, 96ms, etc. to 24.58s.

Attack (Gain Ramp-Down) Time is the time that it takes for the PGA gain to ramp down across 90% of its range (e.g. from 27.75dB down to -15B gain). The time it takes for the recording level to return to its target value therefore depends on both the attack time and on the gain adjustment required. If the gain adjustment is small, it will be shorter than the attack time. The attack time can be programmed in power-of-two (2^n) steps, from 6ms, 12ms, 24ms, etc. to 6.14s.

When operating in stereo, the peak detector takes the maximum of left and right channel peak values, and any new gain setting is applied to both left and right PGAs, so that the stereo image is preserved. However, the ALC function can also be enabled on one channel only. In this case, only one PGA is controlled by the ALC mechanism, while the other channel runs independently with its PGA gain set through the control register.

When one ADC channel is unused, the peak detector disregards that channel. The ALC function can also operate when the two ADC outputs are mixed to mono in the digital domain, but not if they are mixed to mono in the analogue domain, before entering the ADCs.

| REGISTER ADDRESS | BIT | LABEL | DEFAULT | DESCRIPTION |
|----------------------------|-----|------------------|--------------------|--|
| R17 (11h) ALC Control 1 | 8:7 | ALCSEL [1:0] | 00 (OFF) | ALC function select 00 = ALC off (PGA gain set by register) 01 = Right channel only 10 = Left channel only 11 = Stereo (PGA registers unused) Note: ensure that LINVOL and RINVOL settings (reg. 0 and 1) are the same before entering this mode. |
| | 6:4 | MAXGAIN [2:0] | 111 (+30dB) | Set Maximum Gain of PGA 111 : +30dB 110 : +24dB ...(-6dB steps) 001 : -6dB 000 : -12dB |
| | 3:0 | ALCL [3:0] | 1011 (-12dB) | ALC target – sets signal level at ADC input 0000 = -28.5dB FS 0001 = -27.0dB FS ... (1.5dB steps) 1110 = -7.5dB FS 1111 = -6dB FS |
| R18 (12h) ALC Control 2 | 7 | ALCZC | 0 (zero cross off) | ALC uses zero cross detection circuit. |
| | 3:0 | HLD [3:0] | 0000 (0ms) | ALC hold time before gain is increased. 0000 = 0ms 0001 = 2.67ms 0010 = 5.33ms ... (time doubles with every step) 1111 = 43.691s |
| R19 (13h) ALC Control 3 | 7:4 | DCY [3:0] | 0011 (192ms) | ALC decay (gain ramp-up) time 0000 = 24ms 0001 = 48ms 0010 = 96ms ... (time doubles with every step) 1010 or higher = 24.58s |
| | 3:0 | ATK [3:0] | 0010 (24ms) | ALC attack (gain ramp-down) time 0000 = 6ms 0001 = 12ms 0010 = 24ms ... (time doubles with every step) 1010 or higher = 6.14s |

Table 11 ALC Control

PEAK LIMITER

To prevent clipping when a large signal occurs just after a period of quiet, the ALC circuit includes a limiter function. If the ADC input signal exceeds 87.5% of full scale (-1.16dB), the PGA gain is ramped down at the maximum attack rate (as when ATK = 0000), until the signal level falls below 87.5% of full scale. This function is automatically enabled whenever the ALC is enabled.

Note:

If ATK = 0000, then the limiter makes no difference to the operation of the ALC. It is designed to prevent clipping when long attack times are used.

NOISE GATE

When the signal is very quiet and consists mainly of noise, the ALC function may cause “noise pumping”, i.e. loud hissing noise during silence periods. The WM8971L has a noise gate function that prevents noise pumping by comparing the signal level at the LINPUT1/2/3 and/or RINPUT1/2/3 pins against a noise gate threshold, NGTH. The noise gate cuts in when:

- Signal level at ADC [dB] < NGTH [dB] + PGA gain [dB] + Mic Boost gain [dB]

This is equivalent to:

- Signal level at input pin [dB] < NGTH [dB]

The ADC output can then either be muted or digitally attenuated by 18dB. Alternatively, the PGA gain can be held constant (preventing it from ramping up as it normally would when the signal is quiet).

The table below summarises the noise gate control register. The NGTH control bits set the noise gate threshold with respect to the ADC full-scale range. The threshold is adjusted in 1.5dB steps. Levels at the extremes of the range may cause inappropriate operation, so care should be taken with set-up of the function. Note that the noise gate only works in conjunction with the ALC function, and always operates on the same channel(s) as the ALC (left, right, both, or none).

| REGISTER ADDRESS | BIT | LABEL | DEFAULT | DESCRIPTION |
|---------------------------------|-----|---------------|---------|--|
| R20 (14h) Noise Gate Control | 7:3 | NGTH [4:0] | 00000 | Noise gate threshold 00000 -76.5dBfs 00001 -75dBfs ... 1.5 dB steps 11110 -31.5dBfs 11111 -30dBfs |
| | 2:1 | NGG [1:0] | 00 | Noise gate type X0 = PGA gain held constant 01 = mute ADC output 10 = reserved (do not use this setting) 11 = reserved (do not use this setting) |
| | 0 | NGAT | 0 | Noise gate function enable 1 = enable 0 = disable |

Table 12 Noise Gate Control

Note:

The performance of the ADC may degrade at high input signal levels if the monitor bypass mux is selected with MIC boost and ALC enabled.

| REGISTER ADDRESS | BIT | LABEL | DEFAULT | DESCRIPTION |
|---------------------------------|-----|---------|---------|--|
| R5 (05h) ADC and DAC control | 8 | ADCDIV2 | 0 | ADC 6dB attenuate enable 0 = disabled (0dB) 1 = -6dB enabled |
| | 7 | DACDIV2 | 0 | DAC 6dB attenuate enable 0 = disabled (0dB) 1 = -6dB enabled |

Table 13 ADC and DAC 6dB Attenuation Select

OUTPUT SIGNAL PATH

The WM8971L output signal paths consist of digital filters, DACs, analogue mixers and output drivers. The digital filters and DACs are enabled when the WM8971L is in 'playback only' or 'record and playback' mode. The mixers and output drivers can be separately enabled by individual control bits (see Analogue Outputs). Thus it is possible to utilise the analogue mixing and amplification provided by the WM8971L, irrespective of whether the DACs are running or not.

The WM8971L receives digital input data on the DACDAT pin. The digital filter block processes the data to provide the following functions:

- Digital volume control
- Graphic equaliser and Dynamic Bass Boost
- Sigma-Delta Modulation

Two high performance sigma-delta audio DACs convert the digital data into two analogue signals (left and right). These can then be mixed with analogue signals from the LINPUT1/2/3 and RINPUT1/2/3 pins, and the mix is fed to the output drivers, LOUT1/ROUT1, LOUT2/ROUT2 and MONOOUT.

- LOUT1/ROUT1: can drive a 16Ω or 32Ω stereo headphone or stereo line output.
- LOUT2/ROUT2: can drive a 16Ω or 32Ω stereo headphone or stereo line output, or an 8Ω mono speaker.
- MONOOUT: can drive a mono line output or other load down to 10kΩ

DIGITAL DAC VOLUME CONTROL

The signal volume from each DAC can be controlled digitally, in the same way as the ADC volume (see Digital ADC Volume Control). The gain and attenuation range is -127dB to 0dB in 0.5dB steps. The level of attenuation for an eight-bit code X is given by:

$$0.5 \times (X-255) \text{ dB for } 1 \leq X \leq 255; \quad \text{MUTE for } X = 0$$

The LDVU and RDVU control bits control the loading of digital volume control data. When LDVU or RDVU are set to 0, the LDACVOL or RDACVOL control data is loaded into an intermediate register, but the actual gain does not change. Both left and right gain settings are updated simultaneously when either LDVU or RDVU are set to 1.

| REGISTER ADDRESS | BIT | LABEL | DEFAULT | DESCRIPTION |
|--|-----|------------------|---------------------|---|
| R10 (0Ah) Left Channel Digital Volume | 8 | LDVU | 0 | Left DAC Volume Update 0 = Store LDACVOL in intermediate latch (no gain change) 1 = Update left and right channel gains (left = LDACVOL, right = intermediate latch) |
| | 7:0 | LDACVOL [7:0] | 11111111 (0dB) | Left DAC Digital Volume Control 0000 0000 = Digital Mute 0000 0001 = -127dB 0000 0010 = -126.5dB ... 0.5dB steps up to 1111 1111 = 0dB |
| R11 (0Bh) Right Channel Digital Volume | 8 | RDVU | 0 | Right DAC Volume Update 0 = Store RDACVOL in intermediate latch (no gain change) 1 = Update left and right channel gains (left = intermediate latch, right = RDACVOL) |
| | 7:0 | RDACVOL [7:0] | 11111111 (0dB) | Right DAC Digital Volume Control similar to LDACVOL |

Table 14 Digital Volume Control

GRAPHIC EQUALISER

The WM8971L has a digital graphic equaliser and adaptive bass boost function. This function operates on digital audio data before it is passed to the audio DACs. Bass enhancement can take two different forms:

- Linear bass control: bass signals are amplified or attenuated by a user programmable gain. This is independent of signal volume, and very high bass gains on loud signals may lead to signal clipping.
- Adaptive bass boost: The bass volume is amplified by a variable gain. When the bass volume is low, it is boosted more than when the bass volume is high. This method is recommended because it prevents clipping, and usually sounds more pleasant to the human ear.

Treble control applies a user programmable gain, without any adaptive boost function. Bass and treble control are completely independent with separately programmable gains and filter characteristics.

| REGISTER ADDRESS | BIT | LABEL | DEFAULT | DESCRIPTION | | |
|-----------------------------|--------------|---------------|--------------------|--|--------|----------|
| R12 (0Ch) Bass Control | 7 | BB | 0 | Bass Boost 0 = Linear bass control 1 = Adaptive bass boost | | |
| | 6 | BC | 0 | Bass Filter Characteristic 0 = Low Cutoff (130Hz at 48kHz sampling) 1 = High Cutoff (200Hz at 48kHz sampling) | | |
| | 3:0 | BASS [3:0] | 1111 (Disabled) | Bass Intensity | | |
| | | | | Code | BB=0 | BB=1 |
| | | | | 0000 | +9dB | 15 (max) |
| | | | | 0001 | +9dB | 14 |
| | | | | 0010 | +7.5dB | 13 |
| | | | | 0011 | +6dB | 12 |
| | | | | 0100 | +4.5dB | 11 |
| | | | | 0101 | +3dB | 10 |
| | | | | 0110 | +1.5dB | 9 |
| | | | | 0111 | 0dB | 8 |
| | | | | 1000 | -1.5dB | 7 |
| | | | | 1001 | -3dB | 6 |
| | | | | 1010 | -4.5dB | 5 |
| 1011 | -6dB | 4 | | | | |
| 1100 | -6dB | 3 | | | | |
| 1101 | -6dB | 2 | | | | |
| 1110 | -6dB | 1 | | | | |
| 1111 | Bypass (OFF) | | | | | |
| R13 (0Dh) Treble Control | 6 | TC | 0 | Treble Filter Characteristic 0 = High Cutoff (8kHz at 48kHz sampling) 1 = Low Cutoff (4kHz at 48kHz sampling) | | |
| | 3:0 | TRBL [3:0] | 1111 (Disabled) | Treble Intensity 0000 or 0001 = +9dB 0010 = +7.5dB ... (1.5dB steps) 1011 to 1110 = -6dB 1111 = Disable | | |

Table 15 Graphic Equaliser

DIGITAL TO ANALOGUE CONVERTER (DAC)

After passing through the graphic equaliser filters, digital 'de-emphasis' can be applied to the audio data if necessary (e.g. when the data comes from a CD with pre-emphasis used in the recording). De-emphasis filtering is available for sample rates of 48kHz, 44.1kHz and 32kHz.

The WM8971L also has a Soft Mute function, which gradually attenuates the volume of the digital signal to zero. When removed, the gain will ramp back up to the digital gain setting. This function is enabled by default. To play back an audio signal, it must first be disabled by setting the DACMU bit to zero.

| REGISTER ADDRESS | BIT | LABEL | DEFAULT | DESCRIPTION |
|---------------------------------|-----|----------------|---------|--|
| R5 (05h) ADC and DAC Control | 2:1 | DEEMP [1:0] | 00 | De-emphasis Control 11 = 48kHz sample rate 10 = 44.1kHz sample rate 01 = 32kHz sample rate 00 = No De-emphasis |
| | 3 | DACMU | 1 | Digital Soft Mute 1 = mute 0 = no mute (signal active) |

Table 16 DAC Control

The digital audio data is converted to oversampled bit streams in the on-chip, true 24-bit digital interpolation filters. The bitstream data enters two multi-bit, sigma-delta DACs, which convert them to high quality analogue audio signals. The multi-bit DAC architecture reduces high frequency noise and sensitivity to clock jitter. It also uses a Dynamic Element Matching technique for high linearity and low distortion.

In normal operation, the left and right channel digital audio data is converted to analogue in two separate DACs. However, it is also possible to disable one channel, so that the same signal (left or right) appears on both analogue output channels. Additionally, there is a mono-mix mode where the two audio channels are mixed together digitally and then converted to analogue using only one DAC, while the other DAC is switched off. The mono-mix signal can be selected to appear on both analogue output channels.

The DAC output defaults to non-inverted. Setting DACINV will invert the DAC output phase on both left and right channels.

| REGISTER ADDRESS | BIT | LABEL | DEFAULT | DESCRIPTION |
|-------------------------------------|-----|-------------------|---------|---|
| R23 (17h) Additional Control (1) | 5:4 | DMONOMIX [1:0] | 00 | DAC mono mix 00: stereo 01: mono ((L+R)/2) into DACL, '0' into DACR 10: mono ((L+R)/2) into DACR, '0' into DACL 11: mono ((L+R)/2) into DACL and DACR |
| | 1 | DACINV | 0 | DAC phase invert 0 : non-inverted 1 : inverted |

Table 17 DAC Mono Mix and Phase Invert Select

OUTPUT MIXERS

The WM8971L provides the option to mix the DAC output signal with analogue line-in signals from the LINPUT1, RINPUT1, MIC pins or a mono differential input (LINPUT1 – RINPUT1). The level of the mixed-in signals can be controlled with PGAs (Programmable Gain Amplifiers).

The mono mixer is designed to allow a number of signal combinations to be mixed, including the possibility of mixing both the right and left channels together to produce a mono output. To prevent overloading of the mixer when full-scale DAC left and right signals are input, the mixer inputs from the DAC outputs each have a fixed gain of -6dB. The bypass path inputs to the mono mixer have variable gain as determined by R38/R39 bits [6:4].

| REGISTER ADDRESS | BIT | LABEL | DEFAULT | DESCRIPTION |
|------------------------------|-----|---------|---------|---|
| R34 (22h) Left Mixer (1) | 2:0 | LMIXSEL | 000 | Left Input Selection for Output Mix 000 = LINPUT1 011 = Left ADC Input (after PGA / MICBOOST) 100 = Differential input |
| R36 (24h) Right Mixer (1) | 2:0 | RMIXSEL | 000 | Right Input Selection for Output Mix 000 = RINPUT1 001 = MIC 010 = Reserved (do not use) 011 = Right ADC Input (after PGA / MICBOOST) 100 = Differential input |

Table 18 Output Mixer Signal Selection

| REGISTER ADDRESS | BIT | LABEL | DEFAULT | DESCRIPTION |
|-------------------------------------|-----|----------------|------------|---|
| R34 (22h) Left Mixer Control (1) | 8 | LD2LO | 0 | Left DAC to Left Mixer 0 = Disable (Mute) 1 = Enable Path |
| | 7 | LI2LO | 0 | LMIXSEL Signal to Left Mixer 0 = Disable (Mute) 1 = Enable Path |
| | 6:4 | LI2LOVOL [2:0] | 101 (-9dB) | LMIXSEL Signal to Left Mixer Volume 000 = +6dB ... (3dB steps) 111 = -15dB |
| R35 (23h) Left Mixer Control (2) | 8 | RD2LO | 0 | Right DAC to Left Mixer 0 = Disable (Mute) 1 = Enable Path |
| | 7 | RI2LO | 0 | RMIXSEL Signal to Left Mixer 0 = Disable (Mute) 1 = Enable Path |
| | 6:4 | RI2LOVOL [2:0] | 101 (-9dB) | RMIXSEL Signal to Left Mixer Volume 000 = +6dB ... (3dB steps) 111 = -15dB |

Table 19 Left Output Mixer Control

| REGISTER ADDRESS | BIT | LABEL | DEFAULT | DESCRIPTION |
|--------------------------------------|-----|----------------|------------|--|
| R36 (24h) Right Mixer Control (1) | 8 | LD2RO | 0 | Left DAC to Right Mixer 0 = Disable (Mute) 1 = Enable Path |
| | 7 | LI2RO | 0 | LMIXSEL Signal to Right Mixer 0 = Disable (Mute) 1 = Enable Path |
| | 6:4 | LI2ROVOL [2:0] | 101 (-9dB) | LMIXSEL Signal to Right Mixer Volume 000 = +6dB ... (3dB steps) 111 = -15dB |
| R37 (25h) Right Mixer Control (2) | 8 | RD2RO | 0 | Right DAC to Right Mixer 0 = Disable (Mute) 1 = Enable Path |
| | 7 | RI2RO | 0 | RMIXSEL Signal to Right Mixer 0 = Disable (Mute) 1 = Enable Path |
| | 6:4 | RI2ROVOL [2:0] | 101 (-9dB) | RMIXSEL Signal to Right Mixer Volume 000 = +6dB ... (3dB steps) 111 = -15dB |

Table 20 Right Output Mixer Control

| REGISTER ADDRESS | BIT | LABEL | DEFAULT | DESCRIPTION |
|-------------------------------------|-----|----------------|------------|---|
| R38 (26h) Mono Mixer Control (1) | 8 | LD2MO | 0 | Left DAC to Mono Mixer 0 = Disable (Mute) 1 = Enable Path |
| | 7 | LI2MO | 0 | LMIXSEL Signal to Mono Mixer 0 = Disable (Mute) 1 = Enable Path |
| | 6:4 | LI2MOVOL [2:0] | 101 (-9dB) | LMIXSEL Signal to Mono Mixer Volume 000 = +6dB ... (3dB steps) 111 = -15dB |
| R39 (27h) Mono Mixer Control (2) | 8 | RD2MO | 0 | Right DAC to Mono Mixer 0 = Disable (Mute) 1 = Enable Path |
| | 7 | RI2MO | 0 | RMIXSEL Signal to Mono Mixer 0 = Disable (Mute) 1 = Enable Path |
| | 6:4 | RI2MOVOL [2:0] | 101 (-9dB) | RMIXSEL Signal to Mono Mixer Volume 000 = +6dB ... (3dB steps) 111 = -15dB |

Table 21 Mono Output Mixer Control

ANALOGUE OUTPUTS

LOUT1/ROUT1 OUTPUTS

The LOUT1 and ROUT1 pins can drive a 16Ω or 32Ω headphone or a line output (see Headphone Output and Line Output sections, respectively). The signal volume on LOUT1 and ROUT1 can be independently adjusted under software control by writing to LOUT1VOL and ROUT1VOL, respectively. Note that gains over 0dB may cause clipping if the signal is large. Any gain setting below 0101111 (minimum) mutes the output driver. The corresponding output pin remains at the same DC level (the reference voltage on the VREF pin), so that no click noise is produced when muting or un-muting.

A zero cross detect on the analogue output may also be enabled when changing the gain setting to minimize audible clicks and zipper noise as the gain updates. If zero cross is enabled a timeout is also available to update the gain if a zero cross does not occur. This function may be enabled by setting TOEN in register R23 (17h).

| REGISTER ADDRESS | BIT | LABEL | DEFAULT | DESCRIPTION |
|-----------------------------|-----|-------------------|------------------|---|
| R2 (02h) LOUT1 Volume | 8 | LO1VU | 0 | Left Volume Update 0 = Store LOUT1VOL in intermediate latch (no gain change) 1 = Update left and right channel gains (left = LOUT1VOL, right = intermediate latch) |
| | 7 | LO1ZC | 0 | Left zero cross enable 1 = Change gain on zero cross only 0 = Change gain immediately |
| | 6:0 | LOUT1VOL [6:0] | 1111001 (0dB) | LOUT1 Volume 1111111 = +6dB ... (80 steps) 0110000 = -67dB 0101111 to 0000000 = Analogue MUTE |
| R3 (03h) ROUT1 Volume | 8 | RO1VU | 0 | Right Volume Update 0 = Store ROUT1VOL in intermediate latch (no gain change) 1 = Update left and right channel gains (left = intermediate latch, right = ROUT1VOL) |
| | 7 | RO1ZC | 0 | Right zero cross enable 1 = Change gain on zero cross only 0 = Change gain immediately |
| | 6:0 | ROUT1VOL [6:0] | 1111001 | ROUT1 Volume Similar to LOUT1VOL |

Table 22 LOUT1/ROUT1 Volume Control

LOUT2/ROUT2 OUTPUTS

The LOUT2 and ROUT2 output pins are essentially similar to LOUT1 and ROUT1, but they are independently controlled and can also drive an 8Ω mono speaker (see Speaker Output section). For speaker drive, the ROUT2 signal must be inverted (ROUT2INV = 1), so that the left and right channel are mixed to mono in the speaker [L-(R) = L+R].

| REGISTER ADDRESS | BIT | LABEL | DEFAULT | DESCRIPTION |
|--|-----|-------------------|------------------|--|
| R40 (28h) LOUT2 Volume | 6:0 | LOUT2VOL [6:0] | 1111001 (0dB) | Similar to LOUT1VOL |
| | 7 | LO2ZC | 0 | Left zero cross enable 1 = Change gain on zero cross only 0 = Change gain immediately |
| | 8 | LO2VU | 0 | Same as LO1VU |
| R41 (29h) ROUT2 Volume | 6:0 | ROUT2VOL [6:0] | 1111001 (0dB) | Similar ROUT1VOL |
| | 7 | RO2ZC | 0 | Right zero cross enable 1 = Change gain on zero cross only 0 = Change gain immediately |
| | 8 | RO2VU | 0 | Same as RO1VU |
| R24 (18h) Additional Control (2) | 4 | ROUT2INV | 0 | ROUT2 Invert 0 = No Inversion (0° phase shift) 1 = Signal inverted (180° phase shift) |

Table 23 LOUT2/ROUT2 Volume Control**MONO OUTPUT**

The MONOOUT pin can drive a mono line output. The signal volume on MONOOUT can be adjusted under software control by writing to MONOOUTVOL.

| REGISTER ADDRESS | BIT | LABEL | DEFAULT | DESCRIPTION |
|--------------------------------|-----|----------------------|------------------|---|
| R42 (2Ah) MONOOUT Volume | 6:0 | MONOOUT VOL [6:0] | 1111001 (0dB) | MONOOUT Volume 1111111 = +6dB ... (80 steps) 0110000 = -67dB 0101111 to 0000000 = Analogue MUTE |
| | 7 | MOZC | 0 | MONOOUT zero cross enable 1 = Change gain on zero cross only 0 = Change gain immediately |

Table 24 MONOOUT Volume Control

ENABLING THE OUTPUTS

Each analogue output of the WM8971L can be separately enabled or disabled. The analogue mixer associated with each output is powered on or off along with the output pin. All outputs are disabled by default. To save power, unused outputs should remain disabled.

Outputs can be enabled at any time, except when VREF is disabled (VR=0), as this may cause pop noise (see "Power Management" and "Applications Information" sections)

| REGISTER ADDRESS | BIT | LABEL | DEFAULT | DESCRIPTION |
|---|-----|-------|---------|----------------|
| R26 (1Ah) Power Management (2) | 6 | LOUT1 | 0 | LOUT1 Enable |
| | 5 | ROUT1 | 0 | ROUT1 Enable |
| | 4 | LOUT2 | 0 | LOUT2 Enable |
| | 3 | ROUT2 | 0 | ROUT2 Enable |
| | 2 | MONO | 0 | MONOOUT Enable |
| Note: All "Enable" bits are 1 = ON, 0 = OFF | | | | |

Table 25 Analogue Output Control

Whenever an analogue output is disabled, it remains connected to VREF (pin 20) through a resistor. This helps to prevent pop noise when the output is re-enabled. The resistance between VREF and each output can be controlled using the VROI bit in register 27. The default is low (1.5kΩ), so that any capacitors on the outputs can charge up quickly at start-up. If a high impedance is desired for disabled outputs, VROI can then be set to 1, increasing the resistance to about 40kΩ.

| REGISTER ADDRESS | BIT | LABEL | DEFAULT | DESCRIPTION |
|-----------------------------|-----|-------|---------|---|
| R27 (1Bh) Additional (1) | 6 | VROI | 0 | VREF to analogue output resistance 0: 1.5 kΩ 1: 40 kΩ |

Table 26 Disabled Outputs to VREF Resistance

HEADPHONE SWITCH

The HPDETECT pin can be used as a headphone switch control input to automatically disable the speaker output and enable the headphone output e.g. when a headphone is plugged into a jack socket. In this mode, enabled by setting HPSWEN, HPDETECT switches between headphone and speaker outputs (e.g. when the pin is connected to a mechanical switch in the headphone socket to detect plug-in). The HPSWPOL bit reverses the pin's polarity. Note that the LOUT1, ROUT1, LOUT2 and ROUT2 bits in register 26 must also be set for headphone and speaker output (see Table 27 and Table 28).

| HPSWEN | HPSWPOL | HPDETECT (PIN23) | L/ROUT1 (REG. 26) | L/ROUT2 (REG. 26) | HEADPHONE ENABLED | SPEAKER ENABLED |
|--------|---------|------------------|-------------------|-------------------|-------------------|-----------------|
| 0 | X | X | 0 | 0 | no | no |
| 0 | X | X | 0 | 1 | no | yes |
| 0 | X | X | 1 | 0 | yes | no |
| 0 | X | X | 1 | 1 | yes | yes |
| 1 | 0 | 0 | X | 0 | no | no |
| 1 | 0 | 0 | X | 1 | no | yes |
| 1 | 0 | 1 | 0 | X | no | no |
| 1 | 0 | 1 | 1 | X | yes | no |
| 1 | 1 | 0 | 0 | X | no | no |
| 1 | 1 | 0 | 1 | X | yes | no |
| 1 | 1 | 1 | X | 0 | no | no |
| 1 | 1 | 1 | X | 1 | no | yes |

Table 27 Headphone Switch Operation

| REGISTER ADDRESS | BIT | LABEL | DEFAULT | DESCRIPTION |
|-------------------------------------|-----|---------|---------|---|
| R24 (18h) Additional Control (2) | 6 | HPSWEN | 0 | Headphone Switch Enable 0 : Headphone switch disabled 1 : Headphone switch enabled |
| | 5 | HPSWPOL | 0 | Headphone Switch Polarity 0 : HPDETECT high = headphone 1 : HPDETECT high = speaker |

Table 28 Headphone Switch

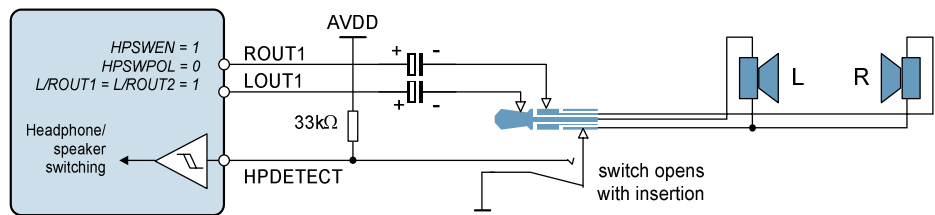

Figure 12 Example Headset Detection Circuit Using Normally-Open Switch

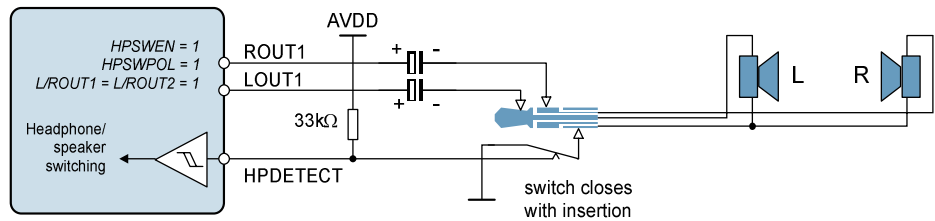

Figure 13 Example Headset Detection Circuit Using Normally-Closed Switch

THERMAL SHUTDOWN

The speaker and headphone outputs can drive very large currents. To protect the WM8971L from overheating a thermal shutdown circuit is included. If the device temperature reaches approximately 150°C and the thermal shutdown circuit is enabled (TSDEN = 1) then the analogue outputs (OUT1L/R, OUT2L/R) will be disabled.

| REGISTER ADDRESS | BIT | LABEL | DEFAULT | DESCRIPTION |
|-------------------------------------|-----|-------|---------|--|
| R23 (17h) Additional Control (1) | 8 | TSDEN | 0 | Thermal Shutdown Enable 0 : thermal shutdown disabled 1 : thermal shutdown enabled |

Table 29 Thermal Shutdown

HEADPHONE OUTPUT

Analogue outputs LOUT1/ROUT1 and LOUT2/ROUT2, can drive a 16Ω or 32Ω headphone load, through DC blocking capacitors.

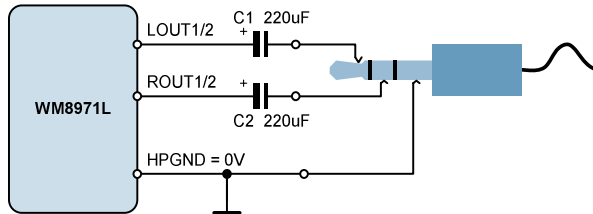

Figure 14 Recommended Headphone Output Configuration

The DC blocking capacitors and the load resistance together determine the lower cut-off frequency, f_c . Increasing the capacitance lowers f_c , improving the bass response. Smaller capacitance values will diminish the bass response. Assuming a 16 Ohm load and $C_1, C_2 = 220\mu\text{F}$:

$$f_c = 1 / 2\pi R_L C_1 = 1 / (2\pi \times 16\Omega \times 220\mu\text{F}) = 45 \text{ Hz}$$

SPEAKER OUTPUT

LOUT2 and ROUT2 can differentially drive a mono 8Ω speaker as shown below.

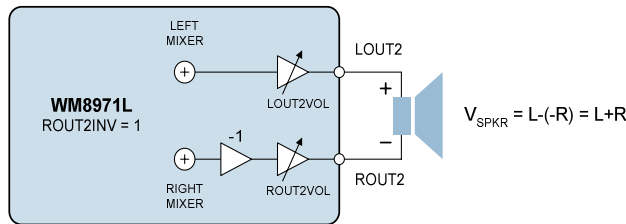

Figure 15 Speaker Output Connection

The right channel is inverted by setting the ROUT2INV bit, so that the signal across the loudspeaker is the sum of left and right channels.

LINE OUTPUT

The analogue outputs, LOUT1/ROUT1 and LOUT2/ROUT2, can be used as line outputs. Recommended external components are shown below.

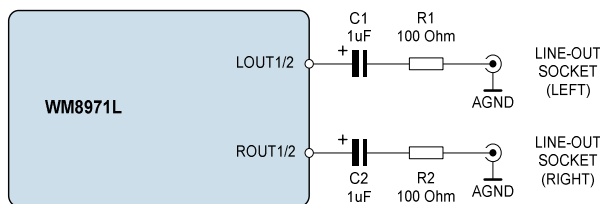

Figure 16 Recommended Circuit for Line Output

The DC blocking capacitors and the load resistance together determine the lower cut-off frequency, f_c . Assuming a 10 kOhm load and $C_1, C_2 = 1\mu\text{F}$:

$$f_c = 1 / 2\pi (R_L + R_1) C_1 = 1 / (2\pi \times 10.1\text{k}\Omega \times 1\mu\text{F}) = 16 \text{ Hz}$$

Increasing the capacitance lowers f_c , improving the bass response. Smaller values of C_1 and C_2 will diminish the bass response. The function of R_1 and R_2 is to protect the line outputs from damage when used improperly.

DIGITAL AUDIO INTERFACE

The digital audio interface is used for inputting DAC data into the WM8971L and outputting ADC data from it. It uses five pins:

- ADCDAT: ADC data output
- ADCLRC: ADC data alignment clock
- DACDAT: DAC data input
- DACLRC: DAC data alignment clock
- BCLK: Bit clock, for synchronisation

The clock signals BCLK, ADCLRC and DACLRC can be outputs when the WM8971L operates as a master, or inputs when it is a slave (see Master and Slave Mode Operation, below).

Four different audio data formats are supported:

- Left justified
- Right justified
- I²S
- DSP mode

All four of these modes are MSB first. They are described in Audio Data Formats, below. Refer to the Electrical Characteristic section for timing information.

MASTER AND SLAVE MODE OPERATION

The WM8971L can be configured as either a master or slave mode device. As a master device the WM8971L generates BCLK, ADCLRC and DACLRC and thus controls sequencing of the data transfer on ADCDAT and DACDAT. In slave mode, the WM8971L responds with data to clocks it receives over the digital audio interface. The mode can be selected by writing to the MS bit (see Table 23). Master and slave modes are illustrated below.

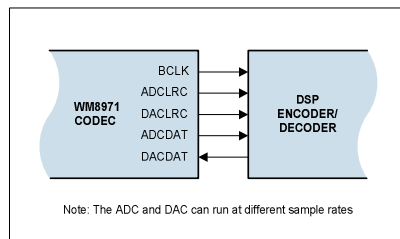

Figure 17 Master Mode

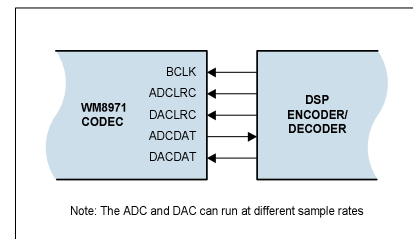

Figure 18 Slave Mode

AUDIO DATA FORMATS

In Left Justified mode, the MSB is available on the first rising edge of BCLK following a LRCLK transition. The other bits up to the LSB are then transmitted in order. Depending on word length, BCLK frequency and sample rate, there may be unused BCLK cycles before each LRCLK transition.

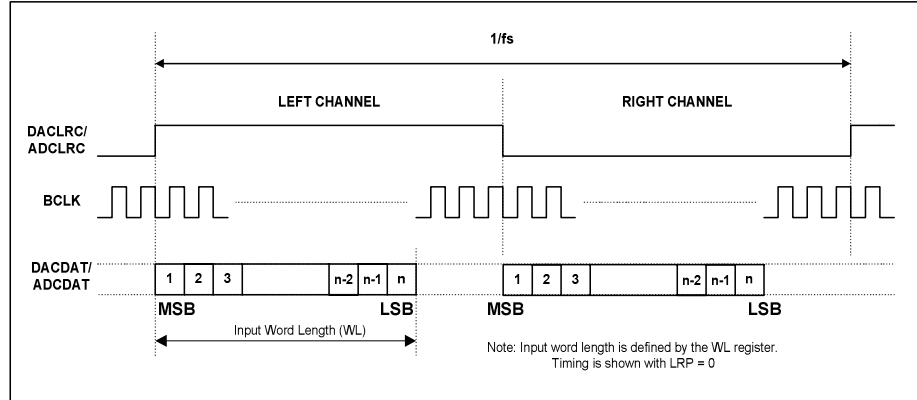

Figure 19 Left Justified Audio Interface (assuming n-bit word length)

In Right Justified mode, the LSB is available on the last rising edge of BCLK before a LRCLK transition. All other bits are transmitted before (MSB first). Depending on word length, BCLK frequency and sample rate, there may be unused BCLK cycles after each LRCLK transition.

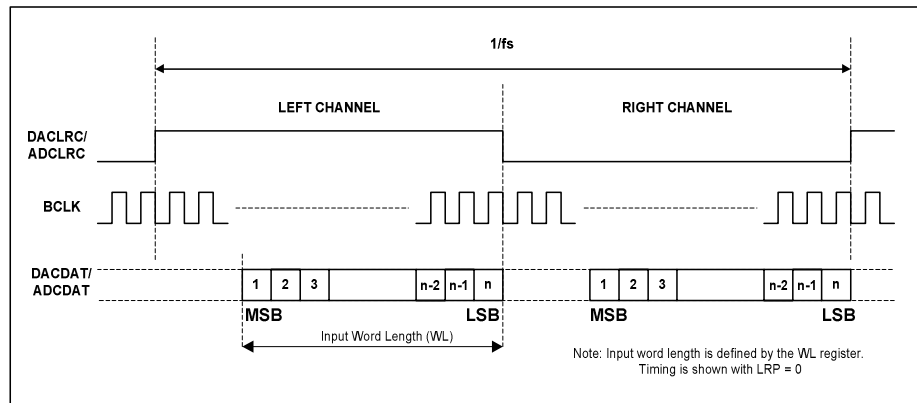

Figure 20 Right Justified Audio Interface (assuming n-bit word length)

In I²S mode, the MSB is available on the second rising edge of BCLK following a LRCLK transition. The other bits up to the LSB are then transmitted in order. Depending on word length, BCLK frequency and sample rate, there may be unused BCLK cycles between the LSB of one sample and the MSB of the next.

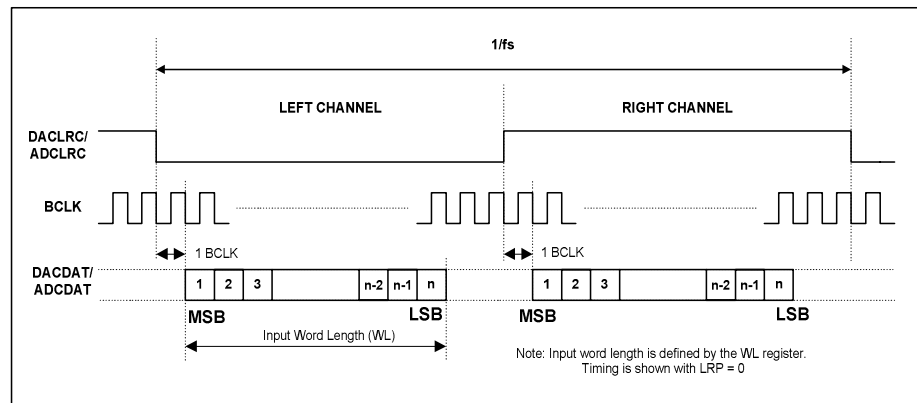

Figure 21 I²S Justified Audio Interface (assuming n-bit word length)

In DSP/PCM mode, the left channel MSB is available on either the 1st (mode B) or 2nd (mode A) rising edge of BCLK (selectable by LRP) following a rising edge of LRC. Right channel data immediately follows left channel data. Depending on word length, BCLK frequency and sample rate, there may be unused BCLK cycles between the LSB of the right channel data and the next sample.

In device master mode, the LRC output will resemble the frame pulse shown in Figure 22 and Figure 23. In device slave mode, Figure 24 and Figure 25, it is possible to use any length of frame pulse less than 1/fs, providing the falling edge of the frame pulse occurs greater than one BCLK period before the rising edge of the next frame pulse.

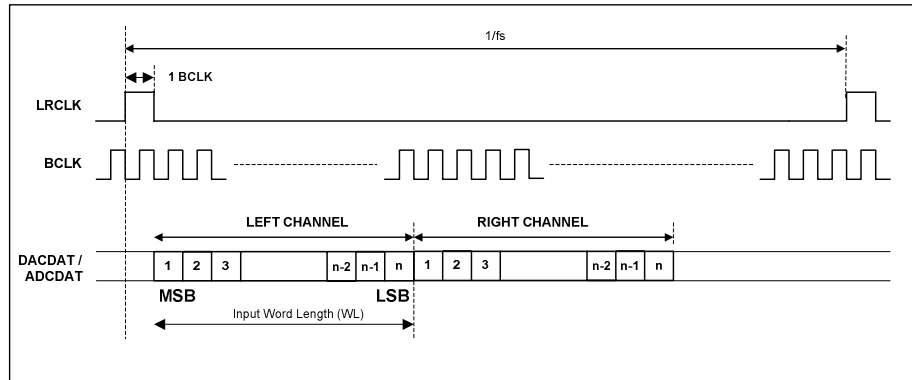

Figure 22 DSP/PCM Mode Audio Interface (mode A, LRP=0, Master)

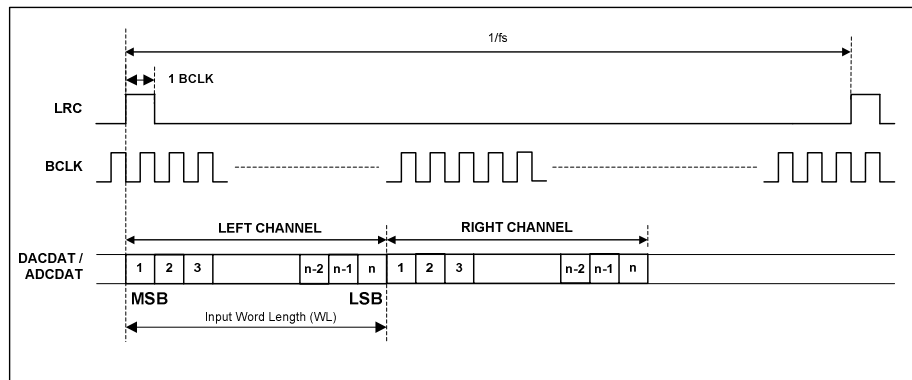

Figure 23 DSP/PCM Mode Audio Interface (mode B, LRP=1, Master)

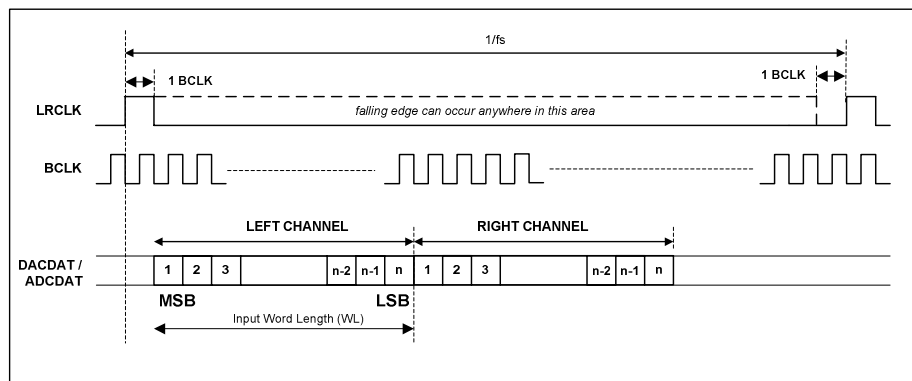

Figure 24 DSP/PCM Mode Audio Interface (mode A, LRP=0, Slave)

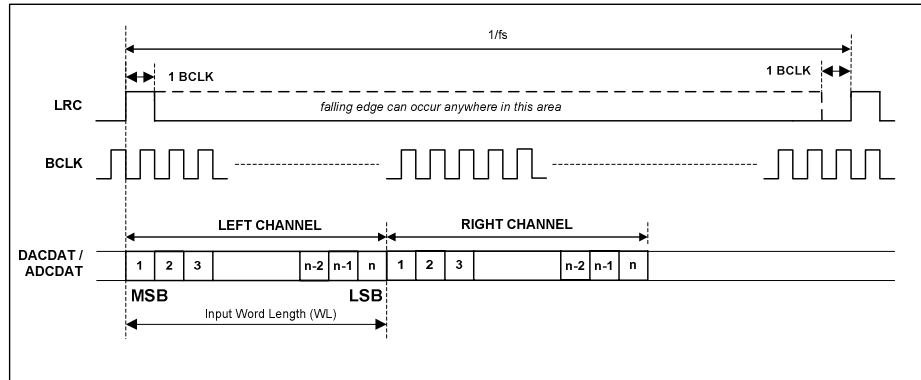

Figure 25 DSP/PCM Mode Audio Interface (mode B, LRP=0, Slave)

AUDIO INTERFACE CONTROL

The register bits controlling audio format, word length and master / slave mode are summarised in Table 30. MS selects audio interface operation in master or slave mode. In Master mode BCLK, ADCLRC and DACLRC are outputs. The frequency of ADCLRC and DACLRC is set by the sample rate control bits SR[4:0] and USB. In Slave mode BCLK, ADCLRC and DACLRC are inputs.

| REGISTER ADDRESS | BIT | LABEL | DEFAULT | DESCRIPTION |
|--|-----|-------------|---------|--|
| R7 (07h) Digital Audio Interface Format | 7 | BCLKINV | 0 | BCLK invert bit (for master and slave modes) 0 = BCLK not inverted 1 = BCLK inverted |
| | 6 | MS | 0 | Master / Slave Mode Control 1 = Enable Master Mode 0 = Enable Slave Mode |
| | 5 | LRSWAP | 0 | Left/Right channel swap 1 = swap left and right DAC data in audio interface 0 = output left and right data as normal |
| | 4 | LRP | 0 | right, left and i2s modes – LRCLK polarity 1 = invert LRCLK polarity 0 = normal LRCLK polarity DSP Mode – mode A/B select 1 = MSB is available on 1st BCLK rising edge after LRC rising edge (mode B) 0 = MSB is available on 2nd BCLK rising edge after LRC rising edge (mode A) |
| | 3:2 | WL[1:0] | 10 | Audio Data Word Length 11 = 32 bits (see Note) 10 = 24 bits 01 = 20 bits 00 = 16 bits |
| | 1:0 | FORMAT[1:0] | 10 | Audio Data Format Select 11 = DSP Mode 10 = I ² S Format 01 = Left justified 00 = Right justified |

Table 30 Audio Data Format Control

Note: Right Justified mode does not support 32-bit data.

AUDIO INTERFACE OUTPUT TRISTATE

Register bit TRI, register 24(18h) bit[3] can be used to tristate the ADCDAT pin and switch ADCLRC, DACLRC and BCLK to inputs. In Slave mode (MASTER=0) ADCLRC, DACLRC and BCLK are by default configured as inputs and only ADCDAT will be tri-stated, (see Table 31).

| REGISTER ADDRESS | BIT | LABEL | DEFAULT | DESCRIPTION |
|------------------------------------|-----|-------|---------|--|
| R24(18h) Additional Control (2) | 3 | TRI | 0 | Tristates ADCDAT and switches ADCLRC, DACLRC and BCLK to inputs. 0 = ADCDAT is an output, ADCLRC, DACLRC and BCLK are inputs (slave mode) or outputs (master mode) 1 = ADCDAT is tristated, ADCLRC, DACLRC and BCLK are inputs |

Table 31 Tri-stating the Audio Interface

MASTER MODE ADCLRC AND DACLRC ENABLE

In Master mode, by default ADCLRC is disabled when the ADC is disabled and DACLRC is disabled when the DAC is disabled. Register bit LRCM, register 24(18h) bit[2] changes the control so that the ADCLRC and DACLRC are disabled only when ADC and DAC are disabled. This enables the user to use e.g. ADCLRC for both ADC and DAC LRCLK and disable the ADC when DAC only operation is required, (see Table 32).

| REGISTER ADDRESS | BIT | LABEL | DEFAULT | DESCRIPTION |
|------------------------------------|-----|-------|---------|---|
| R24(18h) Additional Control (2) | 2 | LRCM | 0 | Selects disable mode for ADCLRC and DACLRC 0 = ADCLRC disabled when ADC (Left and Right) disabled, DACLRC disabled when DAC (Left and Right) disabled. 1 = ADCLRC and DACLRC disabled only when ADC (Left and Right) and DAC (Left and Right) are disabled. |

Table 32 ADCLRC/DACLRC Enable**BIT CLOCK MODE**

The default master mode bit clock generator produces a bit clock frequency based on the sample rate and input MCLK frequency as shown in Table 36. When enabled by setting the appropriate BCM[1:0] bits, the bit clock mode (BCM) function overrides the default master mode bit clock generator to produce the bit clock frequency shown in the table below:

| REGISTER ADDRESS | BIT | LABEL | DEFAULT | DESCRIPTION |
|--|-----|----------|---------|--|
| R8 (08h) Clocking and Sample Rate Control | 8:7 | BCM[1:0] | 00 | BCLK Frequency 00 = BCM function disabled 01 = MCLK/4 10 = MCLK/8 11 = MCLK/16 |

Table 33 Master Mode BCLK Frequency Control

The BCM mode bit clock generator produces 16 or 24 bit clock cycles per sample. The number of bit clock cycles per sample in this mode is determined by the word length bits (WL[1:0]) in the Digital Audio Interface Format register (R7). When these bits are set to 00, there will be 16 bit clock cycles per sample. When these bits are set to 01, 10 or 11, there will be 24 bit clock cycles per sample. Please refer to Figure 26.

The BCM generator uses the ADCLRC signal, hence the ADCLRC signal must be enabled when using bit clock mode. To enable the ADCLRC signal, either the ADC must be powered up or, if the ADC is not in use, the LRCM bit must be set to enable both the ADCLRC and DACLRC signals when either the ADC or the DAC is enabled.

When the BCM function is enabled, the following restrictions apply:

1. The bit clock invert (BCLKINV) function is not available.
2. The DAC and ADC must be operated at the same sample rate.
3. DSP late digital audio interface mode is not available and must not be enabled.

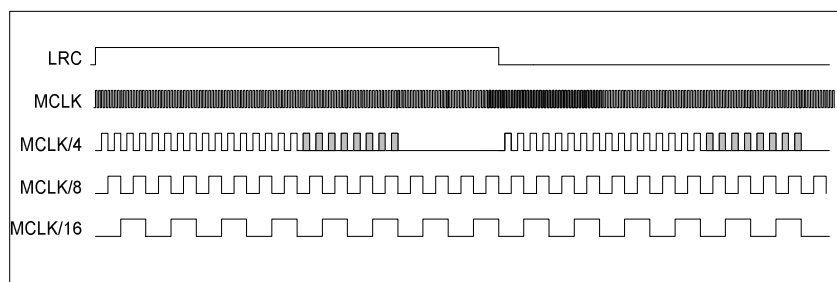
**Figure 26 Bit Clock Mode**

Note: The shaded bit clock cycles are present only when 24-bit mode is selected. Please refer to the "Bit Clock Mode" description for details.

CLOCK OUTPUT

By default ADCLRC (pin 9) is the ADC word clock input/output. Under the control of ADCLRM[1:0], register 27(1Bh) bits [8:7] the ADCLRC pin may be configured as a clock output. If ADCLRM is 01, 10 or 11 then ADCLRC pin is always an output even in slave mode or when TRI = '1', (see Table 34). The ADC then uses the ADCLRC pin as its LRCLK in both master and slave modes.

| REGISTER ADDRESS | BIT | LABEL | DEFAULT | DESCRIPTION |
|------------------------------------|-------|-----------------|---------|--|
| R27(1Bh) Additional Control (3) | [8:7] | ADCLRM [1:0] | 00 | Configures ADCLRC pin 00 = ADCLRC is ADC word clock input (slave mode) or ADCLRC output (master mode) 01 = ADCLRC pin is MCLK output 10 = ADCLRC pin is MCLK / 5.5 output 11 = ADCLRC pin is MCLK / 6 output |

Table 34 ADCLRC Clock Output

CLOCKING AND SAMPLE RATES

The WM8971L supports a wide range of master clock frequencies on the MCLK pin, and can generate many commonly used audio sample rates directly from the master clock. The ADC and DAC do not need to run at the same sample rate; several different combinations are possible.

There are two clocking modes:

- 'Normal' mode supports master clocks of $128f_s$, $192f_s$, $256f_s$, $384f_s$, and their multiples (Note: f_s refers to the ADC or DAC sample rate, whichever is faster)
- USB mode supports 12MHz or 24MHz master clocks. This mode is intended for use in systems with a USB interface, and eliminates the need for an external PLL to generate another clock frequency for the audio codec.

| REGISTER ADDRESS | BIT | LABEL | DEFAULT | DESCRIPTION |
|--|-----|----------|---------|---|
| R8 (08h) Clocking and Sample Rate Control | 6 | CLKDIV2 | 0 | Master Clock Divide by 2 1 = MCLK is divided by 2 0 = MCLK is not divided |
| | 5:1 | SR [4:0] | 00000 | Sample Rate Control |
| | 0 | USB | 0 | Clocking Mode Select 1 = USB Mode 0 = 'Normal' Mode |

Table 35 Clocking and Sample Rate Control

The clocking of the WM8971L is controlled using the CLKDIV2, USB, and SR control bits. Setting the CLKDIV2 bit divides MCLK by two internally. The USB bit selects between 'Normal' and USB mode. Each value of SR[4:0] selects one combination of MCLK division ratios and hence one combination of sample rates (see next page). Since all sample rates are generated by dividing MCLK, their accuracy depends on the accuracy of MCLK. If MCLK changes, the sample rates change proportionately.

Note that some sample rates (e.g. 44.1kHz in USB mode) are approximated, i.e. they differ from their target value by a very small amount. This is not audible, as the maximum deviation is only 0.27% (8.0214kHz instead of 8kHz in USB mode). By comparison, a half-tone step corresponds to a 5.9% change in pitch.

The SR[4:0] bits must be set to configure the appropriate ADC and DAC sample rates in both master and slave mode.

| MCLK CLKDIV2=0 | MCLK CLKDIV2=1 | ADC SAMPLE RATE (ADCLRC) | DAC SAMPLE RATE (DACLRC) | USB | SR [4:0] | FILTER TYPE | BCLK (MS=1) |
|--|-------------------|-----------------------------|-----------------------------|-----|----------|----------------|----------------|
| 'Normal' Clock Mode (** indicates backward compatibility with WM8731) | | | | | | | |
| 12.288 MHz | 24.576 MHz | 8 kHz (MCLK/1536) | 8 kHz (MCLK/1536) | 0 | 00110 * | 1 | MCLK/4 |
| | | 8 kHz (MCLK/1536) | 48 kHz (MCLK/256) | 0 | 00100 * | 1 | MCLK/4 |
| | | 12 kHz (MCLK/1024) | 12 kHz (MCLK/1024) | 0 | 01000 | 1 | MCLK/4 |
| | | 16 kHz (MCLK/768) | 16 kHz (MCLK/768) | 0 | 01010 | 1 | MCLK/4 |
| | | 24 kHz (MCLK/512) | 24 kHz (MCLK/512) | 0 | 11100 | 1 | MCLK/4 |
| | | 32 kHz (MCLK/384) | 32 kHz (MCLK/384) | 0 | 01100 * | 1 | MCLK/4 |
| | | 48 kHz (MCLK/256) | 8 kHz (MCLK/1536) | 0 | 00010 * | 1 | MCLK/4 |
| | | 48 kHz (MCLK/256) | 48 kHz (MCLK/256) | 0 | 00000 * | 1 | MCLK/4 |
| 11.2896MHz | 22.5792MHz | 96 kHz (MCLK/128) | 96 kHz (MCLK/128) | 0 | 01110 * | 3 | MCLK/2 |
| | | 8.0182 kHz (MCLK/1408) | 8.0182 kHz (MCLK/1408) | 0 | 10110 * | 1 | MCLK/4 |
| | | 8.0182 kHz (MCLK/1408) | 44.1 kHz (MCLK/256) | 0 | 10100 * | 1 | MCLK/4 |
| | | 11.025 kHz (MCLK/1024) | 11.025 kHz (MCLK/1024) | 0 | 11000 | 1 | MCLK/4 |
| | | 22.05 kHz (MCLK/512) | 22.05 kHz (MCLK/512) | 0 | 11010 | 1 | MCLK/4 |
| | | 44.1 kHz (MCLK/256) | 8.0182 kHz (MCLK/1408) | 0 | 10010 * | 1 | MCLK/4 |
| | | 44.1 kHz (MCLK/256) | 44.1 kHz (MCLK/256) | 0 | 10000 * | 1 | MCLK/4 |
| 18.432MHz | 36.864MHz | 88.2 kHz (MCLK/128) | 88.2 kHz (MCLK/128) | 0 | 11110 * | 3 | MCLK/2 |
| | | 8 kHz (MCLK/2304) | 8 kHz (MCLK/2304) | 0 | 00111 * | 1 | MCLK/6 |
| | | 8 kHz (MCLK/2304) | 48 kHz (MCLK/384) | 0 | 00101 * | 1 | MCLK/6 |
| | | 12 kHz (MCLK/1536) | 12 kHz (MCLK/1536) | 0 | 01001 | 1 | MCLK/6 |
| | | 16kHz (MCLK/1152) | 16 kHz (MCLK/1152) | 0 | 01011 | 1 | MCLK/6 |
| | | 24kHz (MCLK/768) | 24 kHz (MCLK/768) | 0 | 11101 | 1 | MCLK/6 |
| | | 32 kHz (MCLK/576) | 32 kHz (MCLK/576) | 0 | 01101 * | 1 | MCLK/6 |
| | | 48 kHz (MCLK/384) | 48 kHz (MCLK/384) | 0 | 00001 * | 1 | MCLK/6 |
| 16.9344MHz | 33.8688MHz | 48 kHz (MCLK/384) | 8 kHz (MCLK/2304) | 0 | 00011 * | 1 | MCLK/6 |
| | | 96 kHz (MCLK/192) | 96 kHz (MCLK/192) | 0 | 01111 * | 3 | MCLK/3 |
| | | 8.0182 kHz (MCLK/2112) | 8.0182 kHz (MCLK/2112) | 0 | 10111 * | 1 | MCLK/6 |
| | | 8.0182 kHz (MCLK/2112) | 44.1 kHz (MCLK/384) | 0 | 10101 * | 1 | MCLK/6 |
| | | 11.025 kHz (MCLK/1536) | 11.025 kHz (MCLK/1536) | 0 | 11001 | 1 | MCLK/6 |
| | | 22.05 kHz (MCLK/768) | 22.05 kHz (MCLK/768) | 0 | 11011 | 1 | MCLK/6 |
| | | 44.1 kHz (MCLK/384) | 8.0182 kHz (MCLK/2112) | 0 | 10011 * | 1 | MCLK/6 |
| | | 44.1 kHz (MCLK/384) | 44.1 kHz (MCLK/384) | 0 | 10001 * | 1 | MCLK/6 |
| USB Mode (** indicates backward compatibility with WM8731) | | | | | | | |
| 12.000MHz | 24.000MHz | 88.2 kHz (MCLK/192) | 88.2 kHz (MCLK/192) | 0 | 11111 * | 3 | MCLK/3 |
| | | 8 kHz (MCLK/1500) | 8 kHz (MCLK/1500) | 1 | 00110 * | 0 | MCLK |
| | | 8 kHz (MCLK/1500) | 48 kHz (MCLK/250) | 1 | 00100 * | 0 | MCLK |
| | | 8.0214 kHz (MCLK/1496) | 8.0214kHz (MCLK/1496) | 1 | 10111 * | 1 | MCLK |
| | | 8.0214 kHz (MCLK/1496) | 44.118 kHz (MCLK/272) | 1 | 10101 * | 1 | MCLK |
| | | 11.0259 kHz (MCLK/1088) | 11.0259kHz (MCLK/1088) | 1 | 11001 | 1 | MCLK |
| | | 12 kHz (MCLK/1000) | 12 kHz (MCLK/1000) | 1 | 01000 | 0 | MCLK |
| | | 16kHz (MCLK/750) | 16kHz (MCLK/750) | 1 | 01010 | 0 | MCLK |
| | | 22.0588kHz (MCLK/544) | 22.0588kHz (MCLK/544) | 1 | 11011 | 1 | MCLK |
| | | 24kHz (MCLK/500) | 24kHz (MCLK/500) | 1 | 11100 | 0 | MCLK |
| | | 32 kHz (MCLK/375) | 32 kHz (MCLK/375) | 1 | 01100 * | 0 | MCLK |
| | | 44.118 kHz (MCLK/272) | 8.0214kHz (MCLK/1496) | 1 | 10011 * | 1 | MCLK |
| | | 44.118 kHz (MCLK/272) | 44.118 kHz (MCLK/272) | 1 | 10001 * | 1 | MCLK |
| | | 48 kHz (MCLK/250) | 8 kHz (MCLK/1500) | 1 | 00010 * | 0 | MCLK |
| | | 48 kHz (MCLK/250) | 48 kHz (MCLK/250) | 1 | 00000 * | 0 | MCLK |
| | | 88.235kHz (MCLK/136) | 88.235kHz (MCLK/136) | 1 | 11111 * | 3 | MCLK |
| 96 kHz (MCLK/125) | 96 kHz (MCLK/125) | 1 | 01110 * | 2 | MCLK | | |

Table 36 Master Clock and Sample Rates

CONTROL INTERFACE

SELECTION OF CONTROL MODE

The WM8971L is controlled by writing to registers through a serial control interface. A control word consists of 16 bits. The first 7 bits (B15 to B9) are address bits that select which control register is accessed. The remaining 9 bits (B8 to B0) are data bits, corresponding to the 9 bits in each control register. The control interface can operate as either a 3-wire or 2-wire MPU interface. The MODE pin selects the interface format.

| MODE | INTERFACE FORMAT |
|------|------------------|
| Low | 2 wire |
| High | 3 wire |

Table 37 Control Interface Mode Selection

3-WIRE SERIAL CONTROL MODE

In 3-wire mode, every rising edge of SCLK clocks in one data bit from the SDIN pin. A rising edge on CSB latches in a complete control word consisting of the last 16 bits.

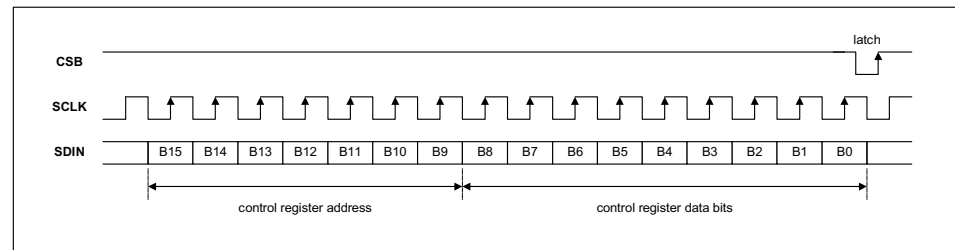

Figure 27 3-Wire Serial Control Interface

2-WIRE SERIAL CONTROL MODE

The WM8971L supports software control via a 2-wire serial bus. Many devices can be controlled by the same bus, and each device has a unique 7-bit address (this is not the same as the 7-bit address of each register in the WM8971L).

The WM8971L operates as a slave device only. The controller indicates the start of data transfer with a high to low transition on SDIN while SCLK remains high. This indicates that a device address and data will follow. All devices on the 2-wire bus respond to the start condition and shift in the next eight bits on SDIN (7-bit address + Read/Write bit, MSB first). If the device address received matches the address of the WM8971L and the R/W bit is '0', indicating a write, then the WM8971L responds by pulling SDIN low on the next clock pulse (ACK). If the address is not recognised or the R/W bit is '1', the WM8971L returns to the idle condition and wait for a new start condition and valid address.

Once the WM8971L has acknowledged a correct address, the controller sends the first byte of control data (B15 to B8, i.e. the WM8971L register address plus the first bit of register data). The WM8971L then acknowledges the first data byte by pulling SDIN low for one clock pulse. The controller then sends the second byte of control data (B7 to B0, i.e. the remaining 8 bits of register data), and the WM8971L acknowledges again by pulling SDIN low.

The transfer of data is complete when there is a low to high transition on SDIN while SCLK is high. After receiving a complete address and data sequence the WM8971L returns to the idle state and waits for another start condition. If a start or stop condition is detected out of sequence at any point during data transfer (i.e. SDIN changes while SCLK is high), the device jumps to the idle condition.

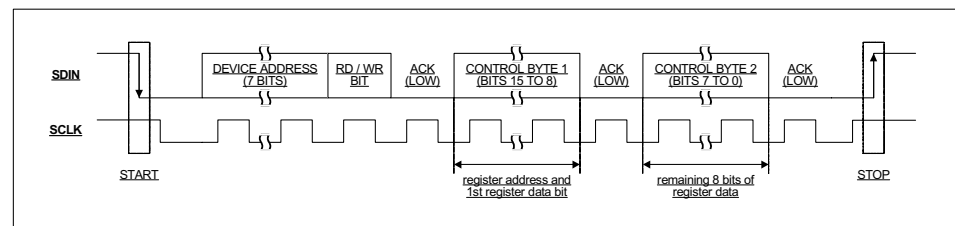

Figure 28 2-Wire Serial Control Interface

The WM8971L has two possible device addresses, which can be selected using the CSB pin.

| CSB STATE | DEVICE ADDRESS |
|-----------|-------------------|
| Low | 0011010 (0 x 34h) |
| High | 0011011 (0 x 36h) |

Table 38 2-Wire MPU Interface Address Selection

POWER SUPPLIES

The WM8971L can use up to four separate power supplies:

- AVDD / AGND: Analogue supply, powers all analogue functions except the headphone drivers. AVDD can range from 1.8V to 3.6V and has the most significant impact on overall power consumption (except for power consumed in the headphone). A large AVDD slightly improves audio quality.
- HPVDD / HPGND: Headphone supply, powers analogue outputs L/ROUT1, L/ROUT2 and MONOOUT. HPVDD is normally tied to AVDD, but requires separate layout and decoupling capacitors to curb harmonic distortion. If HPVDD is lower than AVDD, the output signal may be clipped.
- DCVDD: Digital core supply, powers all digital functions except the audio and control interfaces. DCVDD can range from 1.42V to 3.6V, and has no effect on audio quality. The return path for DCVDD is DGND, which is shared with DBVDD.
- DBVDD: Digital buffer supply, powers the audio and control interface buffers. This makes it possible to run the digital core at very low voltages, saving power, while interfacing to other digital devices using a higher voltage. DBVDD draws much less power than DCVDD, and has no effect on audio quality. DBVDD can range from 1.8V to 3.6V. The return path for DBVDD is DGND, which is shared with DCVDD.

It is possible to use the same supply voltage on all four. However, digital and analogue supplies should be routed and decoupled separately to keep digital switching noise out of the analogue signal paths.

POWER MANAGEMENT

The WM8971L has two control registers that allow users to select which functions are active. For minimum power consumption, unused functions should be disabled. To avoid any pop or click noise, it is important to enable or disable functions in the correct order (see Applications Information). VMIDSEL is the enable for the Vmid reference, which defaults to disabled and can be enabled as a 50kOhm potential divider or, for low power maintenance of Vref when all other blocks are disabled, as a 500kOhm potential divider.

| REGISTER ADDRESS | BIT | LABEL | DEFAULT | DESCRIPTION |
|--|-----|---------|---------|--|
| R25 (19h) Power Management (1) | 8:7 | VMIDSEL | 00 | Vmid divider enable and select 00 – Vmid disabled (for OFF mode) 01 – 50kΩ divider enabled (for playback/record) 10 – 500kΩ divider enabled (for low-power standby) 11 – 5kΩ divider enabled (for fast start-up) |
| | 6 | VREF | 0 | VREF (necessary for all other functions) Power down = 0 Power up = 1 |
| | 5 | AINL | 0 | Analogue in PGA Left Power down = 0 Power up = 1 |
| | 4 | AINR | 0 | Analogue in PGA Right Power down = 0 Power up = 1 |
| | 3 | ADCL | 0 | ADC Left Power down = 0 Power up = 1 |
| | 2 | ADCR | 0 | ADC Right Power down = 0 Power up = 1 |
| | 1 | MICB | 0 | MICBIAS Power down = 0 Power up = 1 |
| R26 (1Ah) Power Management (2) | 8 | DACL | 0 | DAC Left Power down = 0 Power up = 1 |
| | 7 | DACR | 0 | DAC Right Power down = 0 Power up = 1 |
| | 6 | LOUT1 | 0 | LOUT1 Output Buffer* Power down = 0 Power up = 1 |
| | 5 | ROUT1 | 0 | ROUT1 Output Buffer* Power down = 0 Power up = 1 |
| | 4 | LOUT2 | 0 | LOUT2 Output Buffer* Power down = 0 Power up = 1 |
| | 3 | ROUT2 | 0 | ROUT2 Output Buffer* Power down = 0 Power up = 1 |
| | 2 | MONO | 0 | MONOOUT Output Buffer and Mono Mixer Power down = 0 Power up = 1 |
| * The left mixer is enabled when LOUT1=1 or LOUT2=1. The right mixer is enabled when ROUT1=1 or ROUT2=1. | | | | |

Table 39 Power Management

STOPPING THE MASTER CLOCK

In order to minimise power consumed in the digital core of the WM8971L, the master clock may be stopped in Standby and OFF modes. If this cannot be done externally at the clock source, the DIGENB bit (R25, bit 0) can be set to stop the MCLK signal from propagating into the device core. In Standby mode, setting DIGENB will typically provide an additional power saving on DCVDD of 20uA. However, since setting DIGENB has no effect on the power consumption of other system components external to the WM8971L, it is preferable to disable the master clock at its source wherever possible.

| REGISTER ADDRESS | BIT | LABEL | DEFAULT | DESCRIPTION |
|--|-----|--------|---------|---|
| R25 (19h) Additional Control (1) | 0 | DIGENB | 0 | Master clock disable 0: master clock enabled 1: master clock disabled |

Table 40 ADC and DAC Oversampling Rate Selection

Note: Before DIGENB can be set, the control bits ADCL, ADCR, DACL and DACR must be set to zero and a waiting time of 1ms must be observed. Any failure to follow this procedure may prevent DACs and ADCs from re-starting correctly.

SAVING POWER BY REDUCING OVERSAMPLING RATE

The default mode of operation of the ADC and DAC digital filters is in 128x oversampling mode. Under the control of ADCOSR and DACOSR the oversampling rate may be halved. This will result in a slight decrease in noise performance but will also reduce the power consumption of the device.

| REGISTER ADDRESS | BIT | LABEL | DEFAULT | DESCRIPTION |
|--|-----|--------|---------|---|
| R24 (18h) Additional Control (2) | 1 | ADCOSR | 0 | ADC oversample rate select 1 = 64x (lowest power) 0 = 128x (best SNR) |
| | 0 | DACOSR | 0 | DAC oversample rate select 1 = 64x (lowest power) 0 = 128x (best SNR) |

Table 41 ADC and DAC Oversampling Rate Selection

Note: ADCOSR set to 1, 64x oversample mode, is not supported in USB mode (USB=1)

SAVING POWER AT HIGHER SUPPLY VOLTAGES

The analogue supplies to the WM8971L can run from 1.8V to 3.6V. By default, all analogue circuitry on the device is optimized to run at 3.3V. This set-up is also good for all other supply voltages down to 1.8V. At lower voltages, performance can be improved by increasing the bias current. If low power operation is preferred the bias current can be left at the default setting. This is controlled as shown below.

| REGISTER ADDRESS | BIT | LABEL | DEFAULT | DESCRIPTION |
|------------------------------------|-----|---------------|---------|--|
| R23 (17h) Additional Control(1) | 7:6 | VSEL [1:0] | 11 | Analogue Bias optimization 00: Highest bias current, optimized for AVDD=1.8V 01: Bias current, optimized for AVDD=2.5V 1X: Lowest bias current, optimized for AVDD=3.3V |

REGISTER MAP

| REGISTER | ADDRESS (Bit 15 – 9) | remarks | Bit[8] | Bit[7] | Bit[6] | Bit[5] | Bit[4] | Bit[3] | Bit[2] | Bit[1] | Bit[0] | default | page ref |
|-----------|-------------------------|------------------------|--|--------------|---------------|----------------|----------|-------------|--------------|-------------|-----------|-----------|-------------|
| R0 (00h) | 0000000 | Left Input volume | LIVU | LINMUTE | LIZC | LINVOL | | | | | | 010010111 | 21 |
| R1 (01h) | 0000001 | Right Input volume | RIVU | RINMUTE | RIZC | RINVOL | | | | | | 010010111 | 21 |
| R2 (02h) | 0000010 | LOUT1 volume | LO1VU | LO1ZC | LOUT1VOL[6:0] | | | | | | 001111001 | 33 | |
| R3 (03h) | 0000011 | ROUT1 volume | RO1VU | RO1ZC | ROUT1VOL[6:0] | | | | | | 001111001 | 33 | |
| R4 (04h) | 0000100 | Reserved | 0 | 0 | 0 | 0 | 0 | 0 | 0 | 0 | 0 | 000000000 | - |
| R5 (05h) | 0000101 | ADC and DAC Control | ADCDIV2 | DACDIV2 | ADCPOL[1:0] | | HPOR | DACMU | DEEMPH[1:0] | | ADCHPD | 000001000 | 21,27,30 |
| R6 (06h) | 0000110 | Reserved | 0 | 0 | 0 | 0 | 0 | 0 | 0 | 0 | 0 | 000000000 | - |
| R7 (07h) | 0000111 | Audio Interface | 0 | BCLKINV | MS | LRSWAP | LRP | WL[1:0] | | FORMAT[1:0] | | 000001010 | 42 |
| R8 (08h) | 0001000 | Sample rate | BCM[1:0] | | CLKDIV2 | SR[4:0] | | | | USB | 000000000 | 44 | |
| R9 (09h) | 0001001 | Reserved | 0 | 0 | 0 | 0 | 0 | 0 | 0 | 0 | 0 | 000000000 | - |
| R10 (0Ah) | 0001010 | Left DAC volume | LDVU | LDACVOL[7:0] | | | | | | 011111111 | 28 | | |
| R11 (0Bh) | 0001011 | Right DAC volume | RDVU | RDACVOL[7:0] | | | | | | 011111111 | 28 | | |
| R12 (0Ch) | 0001100 | Bass control | 0 | BB | BC | 0 | 0 | BASS[3:0] | | | 000001111 | 29 | |
| R13 (0Dh) | 0001101 | Treble control | 0 | 0 | TC | 0 | 0 | TRBL[3:0] | | | 000001111 | 29 | |
| R15 (0Fh) | 0001111 | Reset | writing to this register resets all registers to their default state | | | | | | | | | not reset | - |
| R16 (10h) | 0010000 | Reserved | 0 | 0 | 0 | 0 | 0 | 0 | 0 | 0 | 0 | 000000000 | - |
| R17 (11h) | 0010001 | ALC1 | ALCSEL[1:0] | | MAXGAIN[2:0] | | | ALCL[3:0] | | | 001111011 | 26 | |
| R18 (12h) | 0010010 | ALC2 | 0 | ALCZC | 0 | 0 | 0 | HLD[3:0] | | | 000000000 | 26 | |
| R19 (13h) | 0010011 | ALC3 | 0 | DCY[3:0] | | | ATK[3:0] | | | 000110010 | 26 | | |
| R20 (14h) | 0010100 | Noise Gate | 0 | NGTH[4:0] | | | | NGG[1:0] | | NGAT | 000000000 | 27 | |
| R21 (15h) | 0010101 | Left ADC volume | LAVU | LADCVOL[7:0] | | | | | | 011000011 | 24 | | |
| R22 (16h) | 0010110 | Right ADC volume | RAVU | RADCVOL[7:0] | | | | | | 011000011 | 24 | | |
| R23 (17h) | 0010111 | Additional control(1) | TSDEN | VSEL[1:0] | | DMONOMIX[1:0] | | DATSEL[1:0] | | DACINV | TOEN | 011000000 | 19,21,30,37 |
| R24 (18h) | 0011000 | Additional control(2) | 0 | 0 | HPSWEN | HPSWPOL | ROUT2INV | TRI | LRCM | ADCOSR | DACOSR | 000000000 | 34, 36,50 |
| R25 (19h) | 0011001 | Pwr Mgmt (1) | VMIDSEL[1:0] | | VREF | AINL | AINR | ADCL | ADCR | MICB | DIGENB | 000000000 | 48 |
| R26 (1Ah) | 0011010 | Pwr Mgmt (2) | DACL | DACR | LOUT1 | ROUT1 | LOUT2 | ROUT2 | MONO | 0 | 0 | 000000000 | 48 |
| R27 (1Bh) | 0011011 | Additional Control (3) | ADCLRM[1:0] | | VROI | HPFLREN | 0 | 0 | 0 | 0 | 0 | 000000000 | 35 |
| R31 (1Fh) | 0011111 | ADC input mode | DS | MONOMIX[1:0] | | 0 | 0 | 0 | 0 | 0 | 0 | 000000000 | 19 |
| R32 (20h) | 0100000 | ADCL signal path | 0 | LINSEL[1:0] | | LMICBOOST[1:0] | | 0 | 0 | 0 | 0 | 000000000 | 19 |
| R33 (21h) | 0100001 | ADCR signal path | 0 | RINSEL[1:0] | | RMICBOOST[1:0] | | 0 | 0 | 0 | 0 | 000000000 | 19 |
| R34 (22h) | 0100010 | Left out Mix (1) | LD2LO | LI2LO | LI2LOVOL[2:0] | | | 0 | LMIXSEL[2:0] | | | 001010000 | 31 |
| R35 (23h) | 0100011 | Left out Mix (2) | RD2LO | RI2LO | RI2LOVOL[2:0] | | | 0 | 0 | 0 | 0 | 001010000 | 31 |
| R36 (24h) | 0100100 | Right out Mix (1) | LD2RO | LI2RO | LI2ROVOL[2:0] | | | 0 | RMIXSEL[2:0] | | | 001010000 | 32 |
| R37 (25h) | 0100101 | Right out Mix (2) | RD2RO | RI2RO | RI2ROVOL[2:0] | | | 0 | 0 | 0 | 0 | 001010000 | 32 |
| R38 (26h) | 0100110 | Mono out Mix (1) | LD2MO | LI2MO | LI2MOVOL[2:0] | | | 0 | 0 | 0 | 0 | 001010000 | 32 |
| R39 (27h) | 0100111 | Mono out Mix (2) | RD2MO | RI2MO | RI2MOVOL[2:0] | | | 0 | 0 | 0 | 0 | 001010000 | 32 |
| R40 (28h) | 0101000 | LOUT2 volume | LO2VU | LO2ZC | LOUT2VOL[6:0] | | | | | | 001111001 | 34 | |
| R41 (29h) | 0101001 | ROUT2 volume | RO2VU | RO2ZC | ROUT2VOL[6:0] | | | | | | 001111001 | 34 | |
| R42 (2Ah) | 0101010 | MONOOUT volume | 0 | MOZC | MOUTVOL[6:0] | | | | | | 001111001 | 34 | |

Note:

- All unused register bits must be set to '0' when writing to WM8971L.

DIGITAL FILTER CHARACTERISTICS

The ADC and DAC employ different digital filters. There are 4 types of digital filter, called Type 0, 1, 2 and 3. The performance of Types 0 and 1 is listed in the table below, the responses of all filters is shown in the proceeding pages.

| PARAMETER | TEST CONDITIONS | MIN | TYP | MAX | UNIT |
|---|-----------------|----------|-------|----------|------|
| ADC Filter Type 0 (USB Mode, 250fs operation) | | | | | |
| Passband | +/- 0.05dB | 0 | | 0.416fs | |
| | -6dB | | 0.5fs | | |
| Passband Ripple | | | | +/- 0.05 | dB |
| Stopband | | 0.584fs | | | |
| Stopband Attenuation | f > 0.584fs | -60 | | | dB |
| ADC Filter Type 1 (USB mode, 272fs or Normal mode operation) | | | | | |
| Passband | +/- 0.05dB | 0 | | 0.4535fs | |
| | -6dB | | 0.5fs | | |
| Passband Ripple | | | | +/- 0.05 | dB |
| Stopband | | 0.5465fs | | | |
| Stopband Attenuation | f > 0.5465fs | -60 | | | dB |
| High Pass Filter Corner Frequency | -3dB | | 3.7 | | Hz |
| | -0.5dB | | 10.4 | | |
| | -0.1dB | | 21.6 | | |
| DAC Filter Type 0 (USB mode, 250fs operation) | | | | | |
| Passband | +/- 0.03dB | 0 | | 0.416fs | |
| | -6dB | | 0.5fs | | |
| Passband Ripple | | | | +/-0.03 | dB |
| Stopband | | 0.584fs | | | |
| Stopband Attenuation | f > 0.584fs | -50 | | | dB |
| DAC Filter Type 1 (USB mode, 272fs or Normal mode operation) | | | | | |
| Passband | +/- 0.03dB | 0 | | 0.4535fs | |
| | -6dB | | 0.5fs | | |
| Passband Ripple | | | | +/- 0.03 | dB |
| Stopband | | 0.5465fs | | | |
| Stopband Attenuation | f > 0.5465fs | -50 | | | dB |

Table 42 Digital Filter Characteristics

| DAC FILTERS | | ADC FILTERS | |
|----------------------------|-------------|----------------------------|-------------|
| Mode | Group Delay | Mode | Group Delay |
| 0 (250 USB) | 11/FS | 0 (250 USB) | 13/FS |
| 1 (256/272) | 16/FS | 1 (256/272) | 23/FS |
| 2 (250 USB, 96k mode) | 4/FS | 2 (250 USB, 96k mode) | 4/FS |
| 3 (256/272, 88.2/96k mode) | 3/FS | 3 (256/272, 88.2/96k mode) | 5/FS |

Table 43 ADC/DAC Digital Filters Group Delay

TERMINOLOGY

1. Stop Band Attenuation (dB) – the degree to which the frequency spectrum is attenuated (outside audio band)
2. Pass-band Ripple – any variation of the frequency response in the pass-band region

DAC FILTER RESPONSES

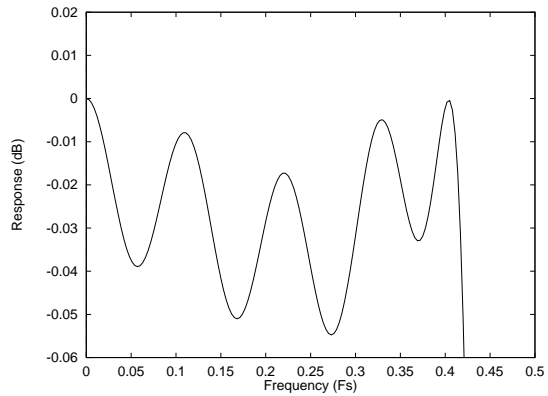
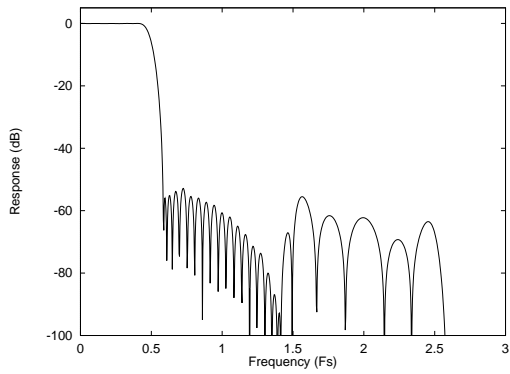

Figure 29 DAC Digital Filter Frequency Response – Type 0 Figure 30 DAC Digital Filter Ripple – Type 0

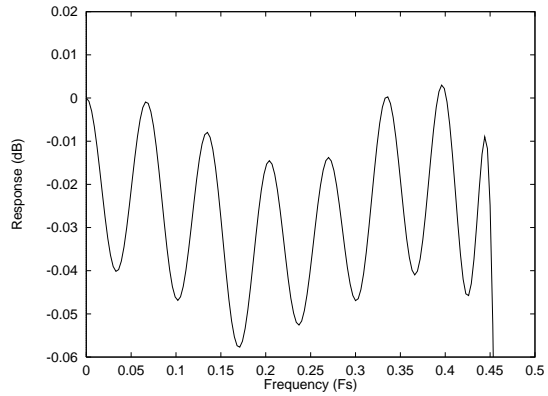
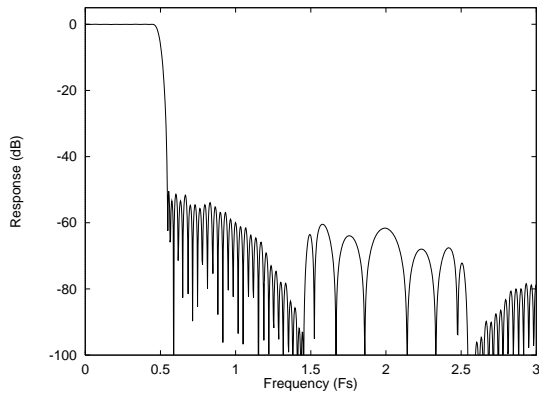

Figure 31 DAC Digital Filter Frequency Response – Type 1 Figure 32 DAC Digital Filter Ripple – Type 1

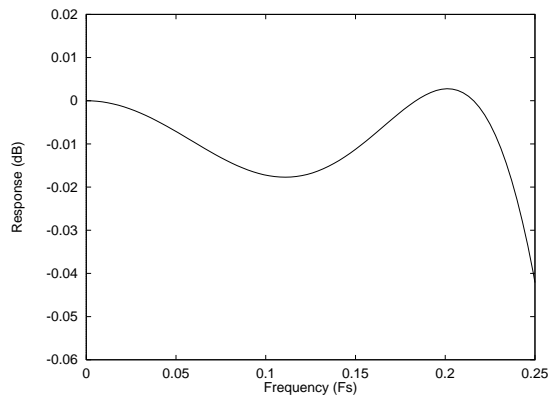
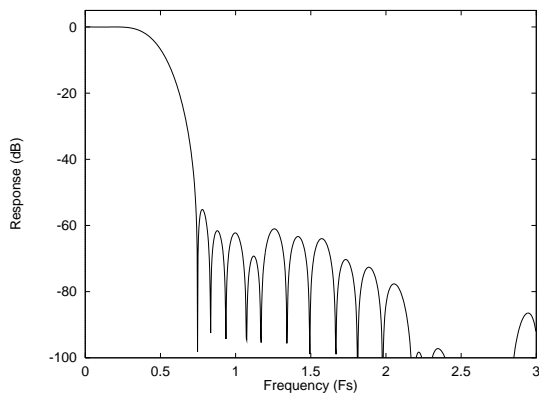

Figure 33 DAC Digital Filter Frequency Response – Type 2 Figure 34 DAC Digital Filter Ripple – Type 2

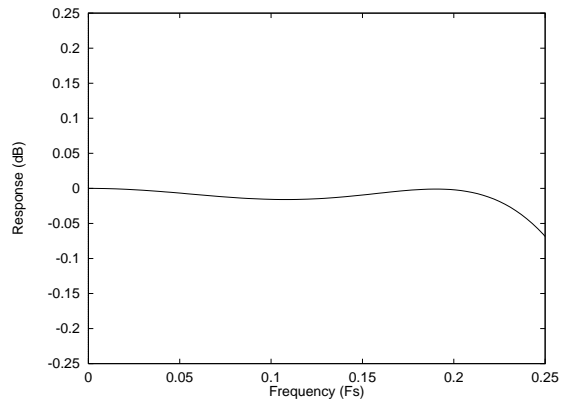
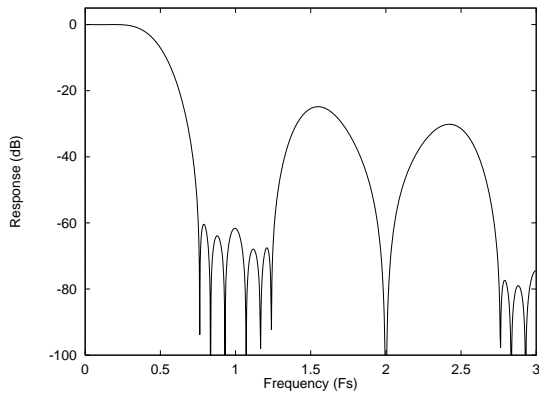

Figure 35 DAC Digital Filter Frequency Response – Type 3 Figure 36 DAC Digital Filter Ripple – Type 3

ADC FILTER RESPONSES

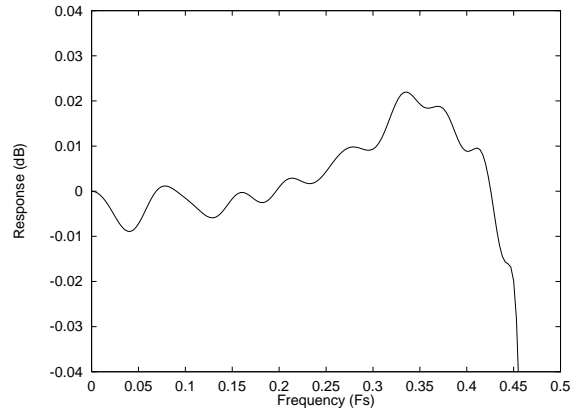
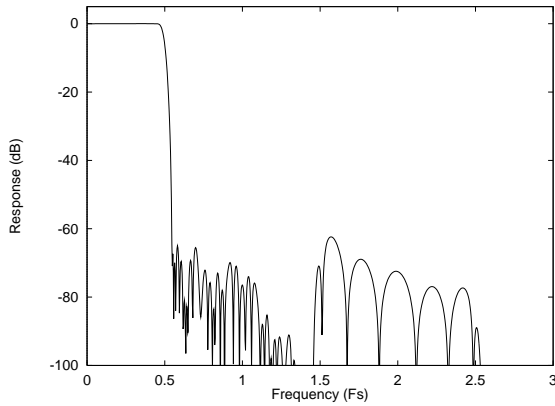

Figure 37 ADC Digital Filter Frequency Response – Type 0

Figure 38 ADC Digital Filter Ripple – Type 0

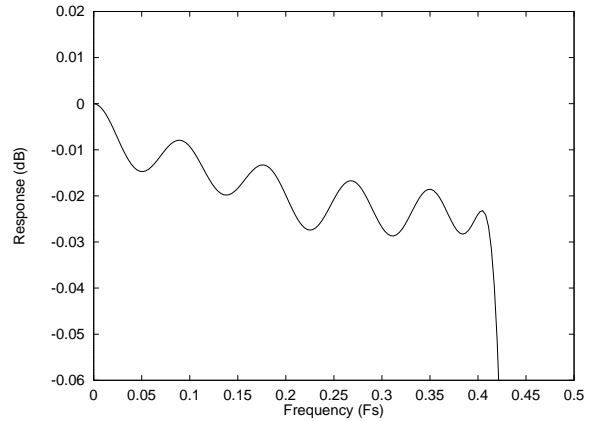
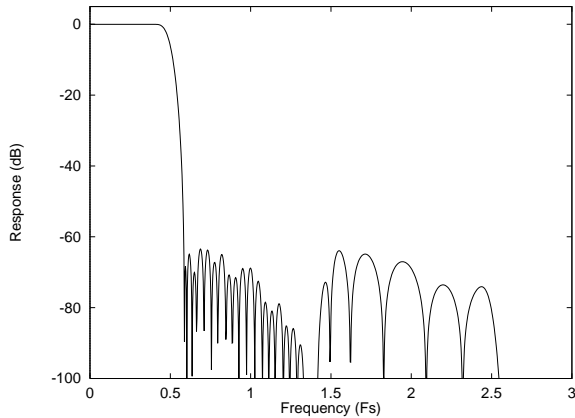

Figure 39 ADC Digital Filter Frequency Response – Type 1

Figure 40 ADC Digital Filter Ripple – Type 1

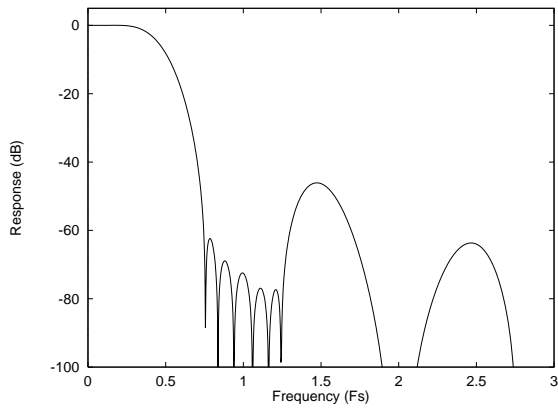

Figure 41 ADC Digital Filter Frequency Response – Type 2

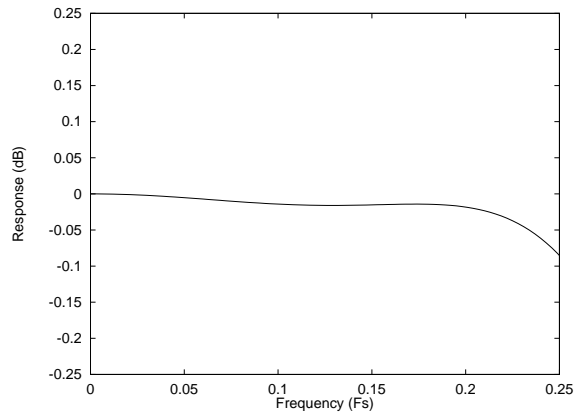

Figure 42 ADC Digital Filter Ripple – Type 2

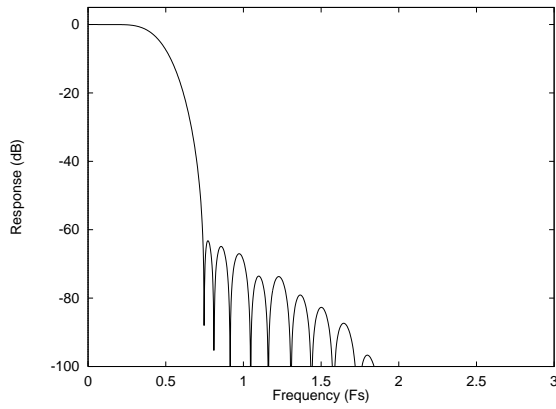

Figure 43 ADC Digital Filter Frequency Response – Type 3

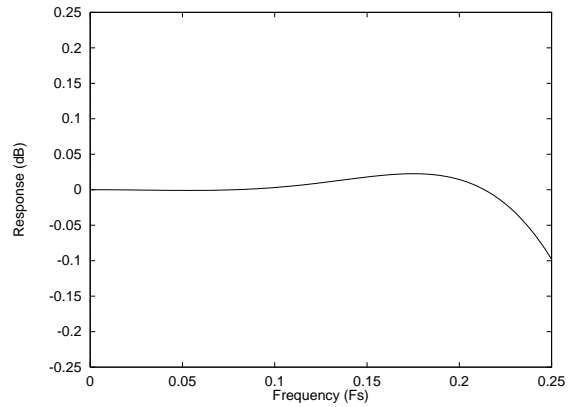

Figure 44 ADC Digital Filter Ripple – Type 3

DE-EMPHASIS FILTER RESPONSES

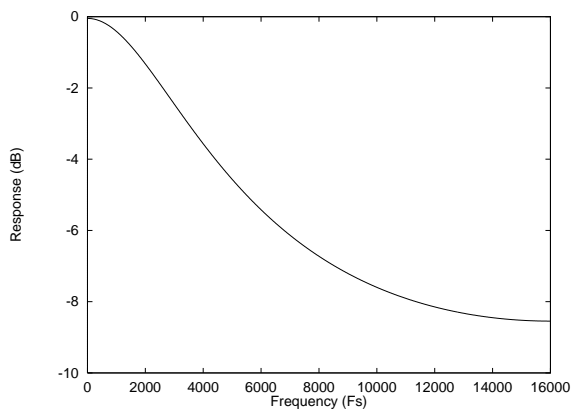

Figure 45 De-emphasis Frequency Response (32kHz)

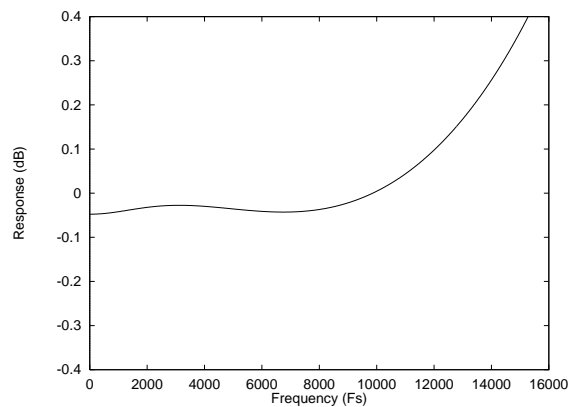

Figure 46 De-emphasis Error (32kHz)

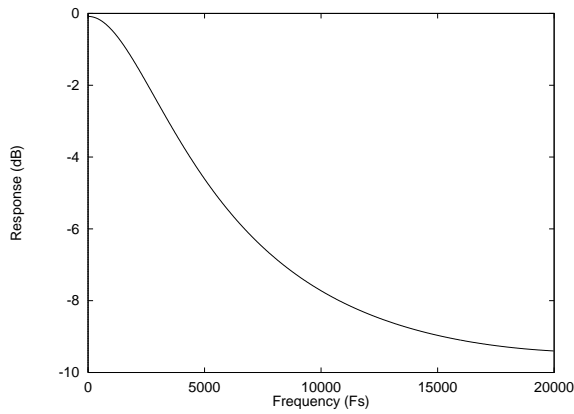

Figure 47 De-emphasis Frequency Response (44.1kHz)

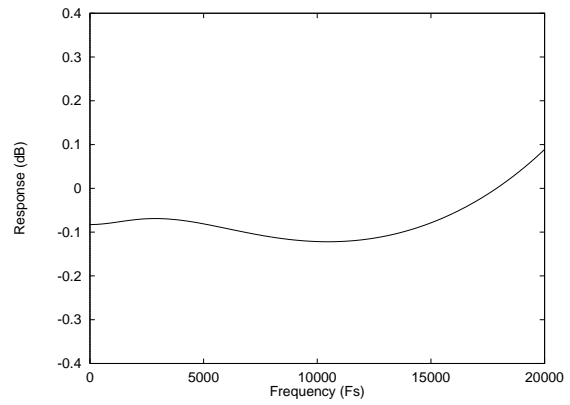

Figure 48 De-emphasis Error (44.1kHz)

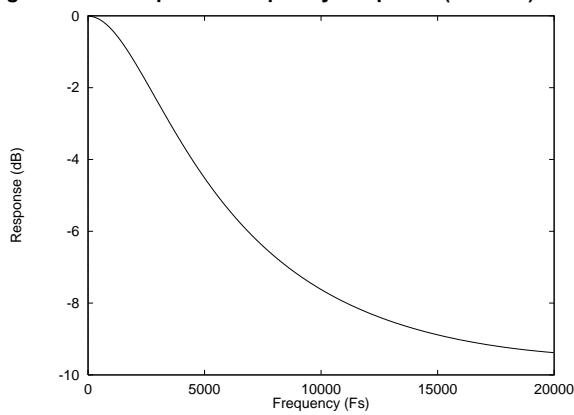

Figure 49 De-emphasis Frequency Response (48kHz)

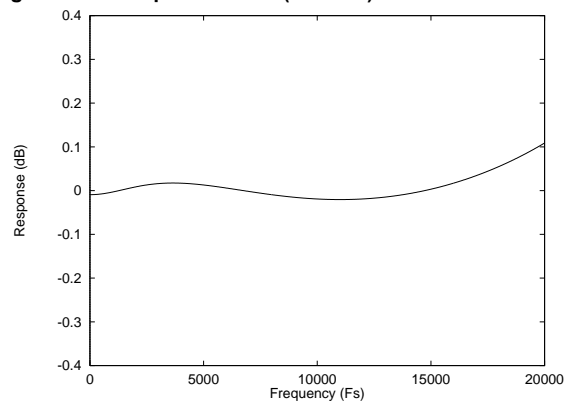

Figure 50 De-emphasis Error (48kHz)

HIGHPASS FILTER

The WM8971L has a selectable digital highpass filter in the ADC filter path to remove DC offsets. The filter response is characterised by the following polynomial:

$$H(z) = \frac{1 - z^{-1}}{1 - 0.9995z^{-1}}$$

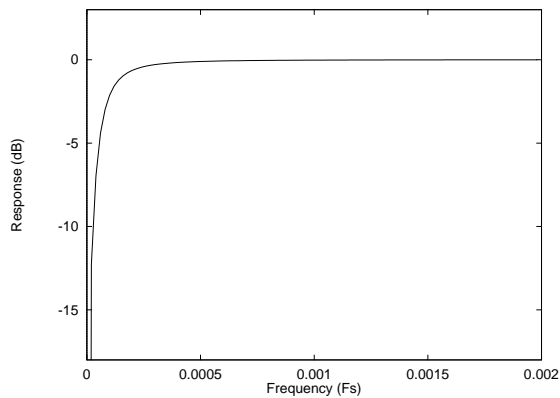

Figure 51 ADC Highpass Filter Response

APPLICATIONS INFORMATION

RECOMMENDED EXTERNAL COMPONENTS

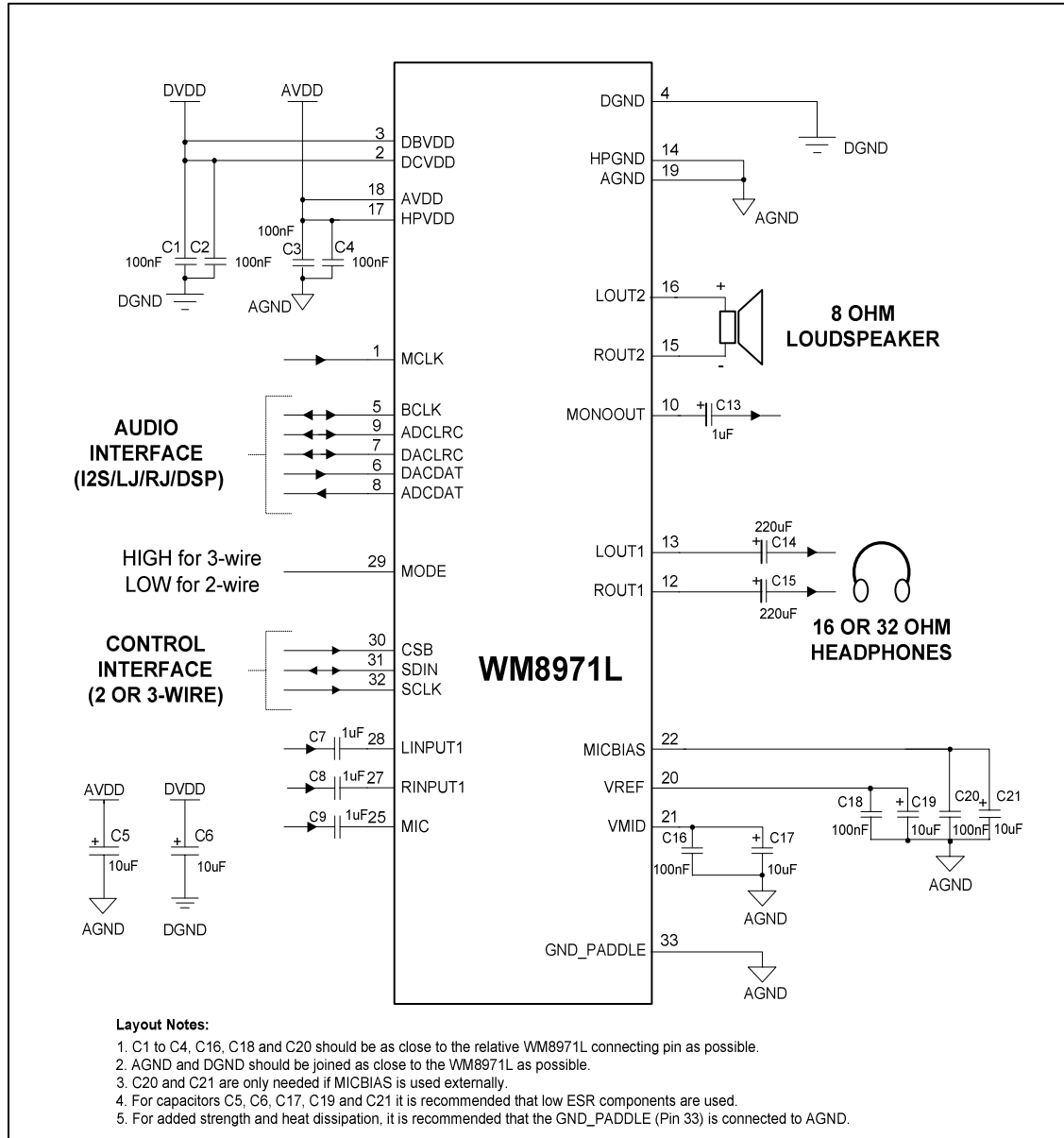

Figure 52 Recommended External Components Diagram

LINE INPUT CONFIGURATION

When LINPUT1/RINPUT1 or MIC are used as line inputs, the microphone boost and ALC functions should normally be disabled.

In order to avoid clipping, the user must ensure that the input signal does not exceed AVDD. This may require a potential divider circuit in some applications. It is also recommended to remove RF interference picked up on any cables using a simple first-order RC filter, as high-frequency components in the input signal may otherwise cause aliasing distortion in the audio band. AC signals with no DC bias should be fed to the WM8971L through a DC blocking capacitor, e.g. 1 μ F.

MICROPHONE INPUT CONFIGURATION

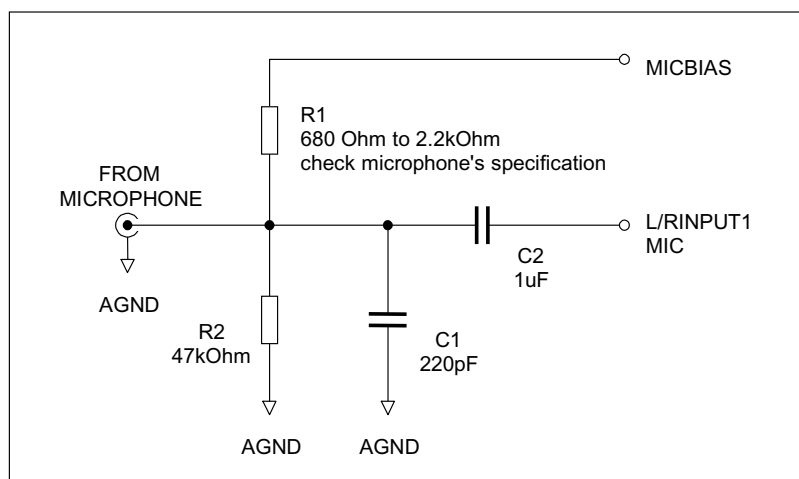

Figure 53 Recommended Circuit for Line Input

For interfacing to a microphone, the ALC function should be enabled and the microphone boost switched on. Microphones held close to a speaker's mouth would normally use the 13dB gain setting, while tabletop or room microphones would need a 29dB boost.

The recommended application circuit is shown above. R1 and R2 form part of the biasing network (refer to Microphone Bias section). R1 connected to MICBIAS is necessary only for electret type microphones that require a voltage bias. R2 should always be present to prevent the microphone input from charging to a high voltage which may damage the microphone on connection. R1 and R2 should be large so as not to attenuate the signal from the microphone, which can have source impedance greater than 2kOhm. C1 together with the source impedance of the microphone and the WM8971L input impedance forms an RF filter. C2 is a DC blocking capacitor to allow the microphone to be biased at a different DC voltage to the MICIN signal.

MINIMISING POP NOISE AT THE ANALOGUE OUTPUTS

To minimise any pop or click noise when the system is powered up or down, the following procedures are recommended.

POWER UP

- Switch on power supplies. By default the WM8971L is in Standby Mode, the DAC is digitally muted and the Audio Interface, Line outputs and Headphone outputs are all OFF (DACMU = 1 Power Management registers 1 and 2 are all zeros).
- Enable Vmid and VREF.
- Enable DACs as required
- Enable line and / or headphone output buffers as required.
- Set DACMU = 0 to soft-un-mute the audio DACs.

POWER DOWN

- Set DACMU = 1 to soft-mute the audio DACs.
- Disable all output buffers.
- Switch off the power supplies.

POWER MANAGEMENT EXAMPLES

| OPERATION MODE | POWER MANAGEMENT (1) | | | | | | | POWER MANAGEMENT (2) | | | | | | |
|---|----------------------|--------|------|-----|------|-----|-----|----------------------|-----|----------------|-----|-----|-----|----|
| | VREF | AINL/R | PGAs | | ADCs | | MBI | DACs | | Output Buffers | | | | |
| | | | PGL | PGR | ADL | ADR | | DAL | DAR | LO1 | RO1 | LO2 | RO2 | MO |
| Stereo Headphone Playback | 1 | 0 | 0 | 0 | 0 | 0 | 0 | 1 | 1 | 1 | 1 | 0 | 0 | 0 |
| Stereo Line-in Record | 1 | 1 | 1 | 1 | 1 | 1 | 0 | 0 | 0 | 0 | 0 | 0 | 0 | 0 |
| Stereo Microphone Record | 1 | 1 | 1 | 1 | 1 | 1 | 1 | 0 | 0 | 0 | 0 | 0 | 0 | 0 |
| Mono Microphone Record | 1 | 1 | 1 | 0 | 1 | 0 | 1 | 0 | 0 | 0 | 0 | 0 | 0 | 0 |
| Stereo Line-in to Headphone Out | 1 | 1 | 0 | 0 | 0 | 0 | 0 | 0 | 0 | 1 | 1 | 0 | 0 | 0 |
| Phone Call | 1 | 1 | 1 | 0 | 0 | 0 | 1 | 0 | 0 | 1 | 1 | 0 | 0 | 1 |
| Speaker Phone Call [ROUT2INV = 1] | 1 | 1 | 1 | 0 | 0 | 0 | 1 | 0 | 0 | 0 | 0 | 1 | 1 | 1 |
| Record Phone Call [L channel = mic with boost, R channel = RX, enable mono mix] | 1 | 1 | 1 | 1 | 1 | 1 | 1 | 0 | 0 | 1 | 1 | 0 | 0 | 1 |

Table 44 Register Settings for Power Management

PACKAGE DIMENSIONS

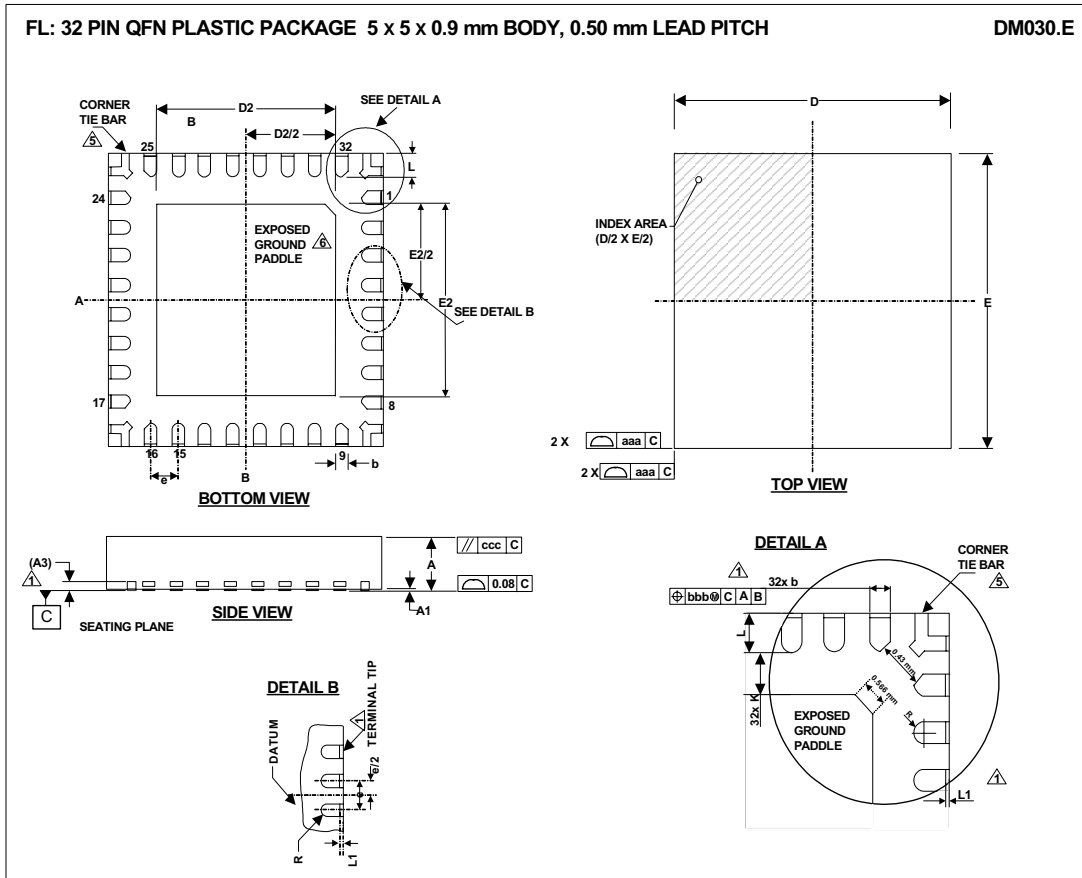

| Symbols | Dimensions (mm) | | | NOTE |
|--|---------------------------------|---------|------|------|
| | MIN | NOM | MAX | |
| A | 0.85 | 0.90 | 1.00 | |
| A1 | 0 | 0.02 | 0.05 | |
| A3 | | 0.2 REF | | |
| b | 0.18 | 0.23 | 0.30 | 1 |
| D | 4.90 | 5.00 | 5.10 | |
| D2 | 3.2 | 3.3 | 3.4 | 2 |
| E | 4.90 | 5.00 | 5.10 | |
| E2 | 3.2 | 3.3 | 3.4 | 2 |
| e | | 0.5 BSC | | |
| L | 0.35 | 0.4 | 0.45 | |
| L1 | | | 0.1 | 1 |
| R | b(min)/2 | | | |
| K | 0.20 | | | |
| Tolerances of Form and Position | | | | |
| aaa | 0.15 | | | |
| bbb | 0.10 | | | |
| ccc | 0.10 | | | |
| REF: | JEDEC, MO-220, VARIATION VHHD-2 | | | |

- NOTES:
- DIMENSION b APPLIED TO METALLIZED TERMINAL AND IS MEASURED BETWEEN 0.25 mm AND 0.30 mm FROM TERMINAL TIP. DIMENSION L1 REPRESENTS TERMINAL PULL BACK FROM PACKAGE SIDE WALL. MAXIMUM OF 0.1mm IS ACCEPTABLE. WHERE TERMINAL PULL BACK EXISTS, ONLY UPPER HALF OF LEAD IS VISIBLE ON PACKAGE SIDE WALL DUE TO HALF ETCHING OF LEADFRAME.
 - FALLS WITHIN JEDEC, MO-220 WITH THE EXCEPTION OF D2, E2.
 - D2,E2: LARGER PAD SIZE CHOSEN WHICH IS JUST OUTSIDE JEDEC SPECIFICATION
 - ALL DIMENSIONS ARE IN MILLIMETRES
 - THIS DRAWING IS SUBJECT TO CHANGE WITHOUT NOTICE.
 - SHAPE AND SIZE OF CORNER TIE BAR MAY VARY WITH PACKAGE TERMINAL COUNT. CORNER TIE BAR IS CONNECTED TO EXPOSED PAD INTERNALLY.
 - REFER TO APPLICATION NOTE WAN_0118 FOR FURTHER INFORMATION REGARDING PCB FOOTPRINTS AND QFN PACKAGE SOLDERING.

IMPORTANT NOTICE

Wolfson Microelectronics plc (WM) reserve the right to make changes to their products or to discontinue any product or service without notice, and advise customers to obtain the latest version of relevant information to verify, before placing orders, that information being relied on is current. All products are sold subject to the WM terms and conditions of sale supplied at the time of order acknowledgement, including those pertaining to warranty, patent infringement, and limitation of liability.

WM warrants performance of its products to the specifications applicable at the time of sale in accordance with WM's standard warranty. Testing and other quality control techniques are utilised to the extent WM deems necessary to support this warranty. Specific testing of all parameters of each device is not necessarily performed, except those mandated by government requirements.

In order to minimise risks associated with customer applications, adequate design and operating safeguards must be used by the customer to minimise inherent or procedural hazards. Wolfson products are not authorised for use as critical components in life support devices or systems without the express written approval of an officer of the company. Life support devices or systems are devices or systems that are intended for surgical implant into the body, or support or sustain life, and whose failure to perform when properly used in accordance with instructions for use provided, can be reasonably expected to result in a significant injury to the user. A critical component is any component of a life support device or system whose failure to perform can be reasonably expected to cause the failure of the life support device or system, or to affect its safety or effectiveness.

WM assumes no liability for applications assistance or customer product design. WM does not warrant or represent that any license, either express or implied, is granted under any patent right, copyright, mask work right, or other intellectual property right of WM covering or relating to any combination, machine, or process in which such products or services might be or are used. WM's publication of information regarding any third party's products or services does not constitute WM's approval, license, warranty or endorsement thereof.

Reproduction of information from the WM web site or datasheets is permissible only if reproduction is without alteration and is accompanied by all associated warranties, conditions, limitations and notices. Representation or reproduction of this information with alteration voids all warranties provided for an associated WM product or service, is an unfair and deceptive business practice, and WM is not responsible nor liable for any such use.

Resale of WM's products or services with statements different from or beyond the parameters stated by WM for that product or service voids all express and any implied warranties for the associated WM product or service, is an unfair and deceptive business practice, and WM is not responsible nor liable for any such use.

ADDRESS:

Wolfson Microelectronics plc
26 Westfield Road
Edinburgh
EH11 2QB
United Kingdom

Tel :: +44 (0)131 272 7000

Fax :: +44 (0)131 272 7001

Email :: sales@wolfsonmicro.com

Revision History

| DATE | RELEASE | DESCRIPTION OF CHANGES | PAGES |
|----------|---------|--|-------|
| 14/08/03 | 2.0 | Initial Release | |
| 30/03/04 | 3.0 | Pin Configuration – Pins 11, 24 and 26 renamed | 4 |
| | | Ordering Information – Peak Soldering Temp added and order codes changed | 5 |
| | | Pin Description – Pin Descriptions for 11, 24 and 26 changed | 8 |
| | | Speaker Output Power updated | |
| 12/05/04 | 4.0 | Updated to Production Data | |
| | | Block Diagram ROUT2 updated to show inverting buffer, buffer added to LD2MO and RD2MO | 1 |
| | | Pin Diagram rotated | 4 |
| | | Pin Description, Ground padded note added | 5 |
| | | Recommended Operating Conditions, DBVDD to 1.7 | 6 |
| | | Electrical Characteristics updated, Speaker Output | 8 |
| | | Speaker THD and Noise Versus Power added | 11 |
| | | Fig 3, Bit Clock Mode added | 14 |
| | | Control Interface Timing 3-wire mode test conditions table updated | 16 |
| | | Power on Reset added | 17 |
| | | Speaker Output THD Versus Power removed | |
| | | PGA Control text updated | 21 |
| | | Automatic Level Control text updated | 25 |
| | | Note added to Noise Gate Control table | 27 |
| | | Output Mixers, mono mixer para added | 31 |
| | | Timing Diagrams, Figs, 17, 18 and 19 updated LRP = 1 changed to LRP = 0 | 39 |
| | | DSP diagrams updated, Figs 20, 21 | 41 |
| | | Bit Clock added | 43 |
| | | Clock Output table and text updated | 44 |
| | | Updates to Table 38 Power Management | 48 |
| | | Register Map HPFLREN added to R27, R8, Bit 8 & 7 BCM[1:0] added | 50 |
| | | Group Delay added | 51 |
| | | Recommended External Component diagram updated to show component values, ground paddle added | 56 |
| | | External component values table deleted | 57 |
| | | Ref updated in Package Drawing | 59 |
| 16/08/05 | 4.2 | Ordering information – leaded parts removed | 4 |
| | | Pin description - Changed pin 19 description | 5 |
| | | Electrical Characteristics – ADC THD max values removed | 7 |
| | | Updated Operation Mode table (Stereo Headphone playback, AINL/UR changed from 1 to 0) | 58 |
| | | Package Drawing updated to DM030.E to include ground paddle info | 59 |