

Optocoupler, Phototransistor Output, AC Input, With Base Connection

Features

- AC or Polarity Insensitive Input
- Built-in Reverse Polarity Input Protection
- Improved CTR Symmetry
- Industry Standard DIP Package
- Lead-free component
- Component in accordance to RoHS 2002/95/EC and WEEE 2002/96/EC

Single Channel

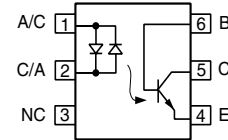
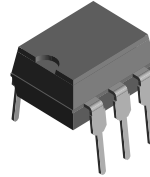

Dual Channel

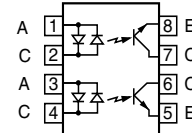
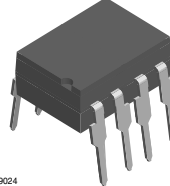

1179024



Agency Approvals

- UL1577, File No. E52744 System Code H or J, Double Protection
- CSA 93751
- BSI IEC60950 IEC60065
- DIN EN 60747-5-2 (VDE0884)
DIN EN 60747-5-5 pending
Available with Option 1

Applications

Ideal for AC signal detection and monitoring.

Description

The IL250/ 251/ 252/ ILD250/ 251/ 252 are bidirectional input optically coupled isolators consisting of two Gallium Arsenide infrared LEDs coupled to a silicon NPN phototransistor per channel.

The IL250/ ILD250 has a minimum CTR of 50 %, the IL251/ ILD251 has a minimum CTR of 20 %, and the IL252/ ILD252 has a minimum CTR of 100 %.

The IL250/ IL251/ IL252 are single channel optocouplers. The ILD250/ ILD251/ ILD252 has two isolated channels in a single DIP package.

Order Information

Part	Remarks
IL250	CTR > 50 %, Single Channel DIP-6
IL251	CTR > 20 %, Single Channel DIP-6
IL252	CTR > 100 %, Single Channel DIP-6
ILD250	CTR > 50 %, Dual Channel DIP-8
ILD251	CTR > 20 %, Dual Channel DIP-8
ILD252	CTR > 100 %, Dual Channel DIP-8
IL250-X007	CTR > 50 %, Single Channel SMD-6 (option 7)
IL250-X009	CTR > 50 %, Single Channel SMD-6 (option 9)
IL251-X009	CTR > 20 %, Single Channel SMD-6 (option 9)
IL252-X007	CTR > 100 %, Single Channel SMD-6 (option 7)
IL252-X009	CTR > 100 %, Single Channel SMD-6 (option 9)
ILD250-X009	CTR > 50 %, Dual Channel SMD-6 (option 9)
ILD251-X006	CTR > 20 %, Dual Channel DIP-8 400 mil (option 6)
ILD251-X007	CTR > 20 %, Dual Channel SMD-6 (option 7)
ILD251-X009	CTR > 20 %, Dual Channel SMD-6 (option 9)
ILD252-X009	CTR > 100 %, Dual Channel SMD-6 (option 9)

For additional information on the available options refer to Option Information.

Absolute Maximum Ratings

$T_{amb} = 25\text{ °C}$, unless otherwise specified

Stresses in excess of the absolute Maximum Ratings can cause permanent damage to the device. Functional operation of the device is not implied at these or any other conditions in excess of those given in the operational sections of this document. Exposure to absolute Maximum Rating for extended periods of the time can adversely affect reliability.

Input

Parameter	Test condition	Symbol	Value	Unit
Forward continuous current		I_F	60	mA
Power dissipation		P_{diss}	100	mW
Derate linearly from 25 °C			1.33	mw/°C

Output

Parameter	Test condition	Symbol	Value	Unit
Collector-emitter breakdown voltage		BV_{CEO}	30	V
Emitter-base breakdown voltage		BV_{EBO}	5.0	V
Collector-base breakdown voltage		BV_{CBO}	70	V
Power dissipation single channel		P_{diss}	200	mW
Power dissipation dual channel		P_{diss}	150	mW
Derate linearly from 25 °C single channel			2.6	mW/°C
Derate linearly from 25 °C dual channel			2.0	mW/°C

Coupler

Parameter	Test condition	Symbol	Value	Unit
Isolation test voltage (between emitter and detector referred to standard climate 23 °C/50 %RH, DIN 50014)		V_{ISO}	5300	V_{RMS}
Creepage			≥ 7.0	mm
Clearance			≥ 7.0	mm
Isolation resistance	$V_{IO} = 500\text{ V}, T_{amb} = 25\text{ °C}$	R_{IO}	10^{12}	Ω
	$V_{IO} = 500\text{ V}, T_{amb} = 100\text{ °C}$	R_{IO}	10^{11}	Ω
Total dissipation single channel		P_{tot}	250	mW
Total dissipation dual channel		P_{tot}	400	mW
Derate linearly from 25 °C single channel			3.3	mW/°C
Derate linearly from 25 °C dual channel			5.3	mW/°C
Storage temperature		T_{stg}	- 55 to + 150	°C
Operating temperature		T_{amb}	- 55 to + 100	°C
Lead soldering time at 260 °C			10	sec.

Electrical Characteristics

$T_{amb} = 25\text{ }^{\circ}\text{C}$, unless otherwise specified

Minimum and maximum values are testing requirements. Typical values are characteristics of the device and are the result of engineering evaluation. Typical values are for information only and are not part of the testing requirements.

Input

Parameter	Test condition	Symbol	Min	Typ.	Max	Unit
Forward voltage	$I_F = \pm 10\text{ mA}$	V_F		1.2	1.5	V

Output

Parameter	Test condition	Symbol	Min	Typ.	Max	Unit
Collector-emitter breakdown voltage	$I_C = 1.0\text{ mA}$	BV_{CEO}	30	50		V
Emitter-base breakdown voltage	$I_E = 100\text{ }\mu\text{A}$	BV_{EBO}	7.0	10		V
Collector-base breakdown voltage	$I_C = 10\text{ }\mu\text{A}$	BV_{CBO}	70	90		V
Collector-emitter leakage current	$V_{CE} = 10\text{ V}$	I_{CEO}		5.0	50	nA

Coupler

Parameter	Test condition	Symbol	Min	Typ.	Max	Unit
Collector-emitter saturation voltage	$I_F = \pm 16\text{ mA}$, $I_C = 2.0\text{ mA}$	V_{CEsat}			0.4	V

Current Transfer Ratio

Parameter	Test condition	Part	Symbol	Min	Typ.	Max	Unit
DC Current Transfer Ratio	$I_F = \pm 10\text{ mA}$, $V_{CE} = 10\text{ V}$	IL250/ILD250	CTR_{DC}	50			%
		IL251/ILD251	CTR_{DC}	20			%
		IL252/ILD252	CTR_{DC}	100			%
Symmetry (CTR @ +10 mA)/ (CTR @ -10 mA)				0.50	1.0	2.0	

Typical Characteristics ($T_{amb} = 25\text{ }^{\circ}\text{C}$ unless otherwise specified)

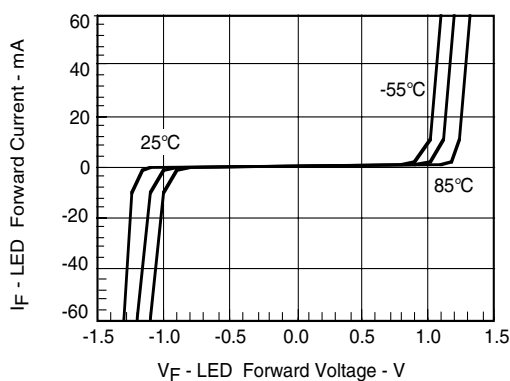

il250_01

Figure 1. LED Forward Current vs. Forward Voltage

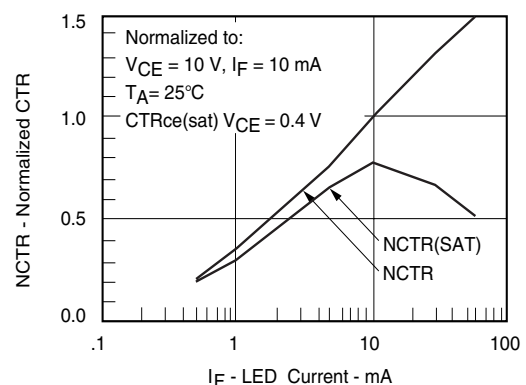

il250_02

Figure 2. Normalized Non-Saturated and Saturated CTR vs. LED Current

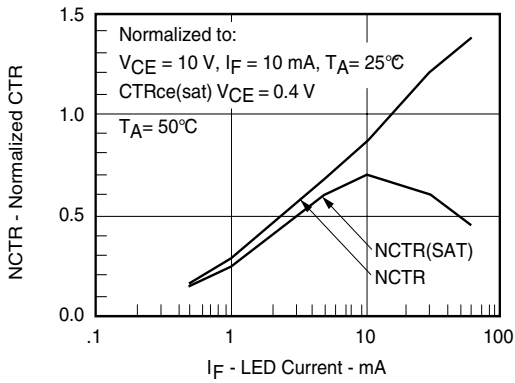

#250_03

Figure 3. Normalized Non-saturated and Saturated CTR vs. LED Current

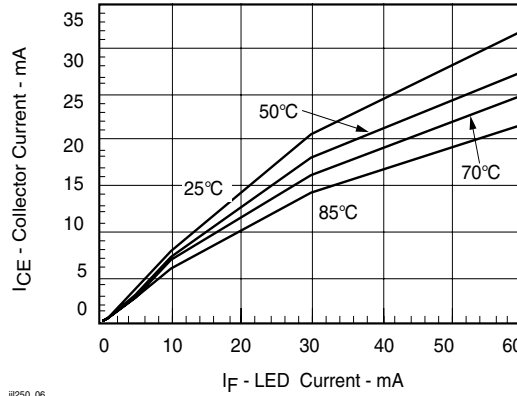

#250_06

Figure 6. Collector-Emitter Current vs. Temperature and LED Current

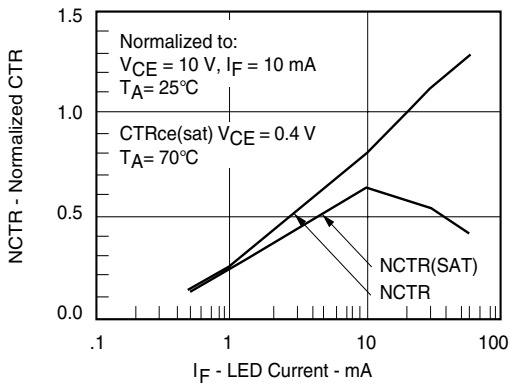

#250_04

Figure 4. Normalized Non-saturated and saturated CTR vs. LED Current

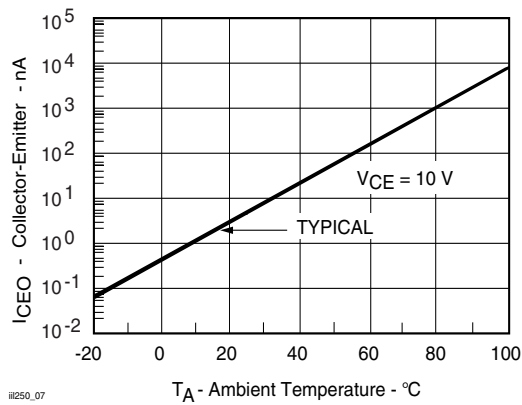

#250_07

Figure 7. Collector-Emitter Leakage Current vs. Temp.

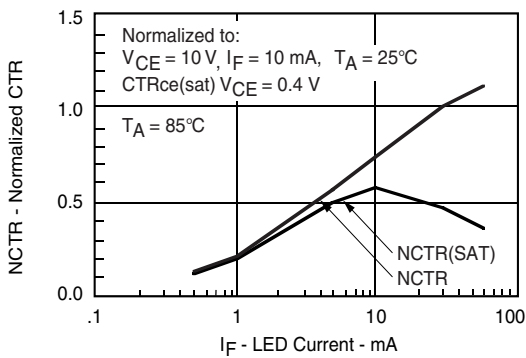

#250_05

Figure 5. Normalized Non-saturated and saturated CTR vs. LED Current

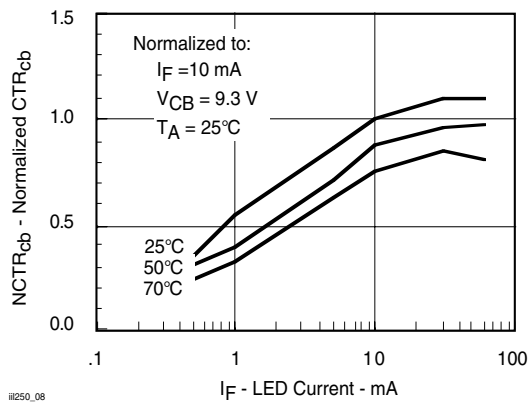

#250_08

Figure 8. Normalized CTR_{cb} vs. LED Current and Temperature

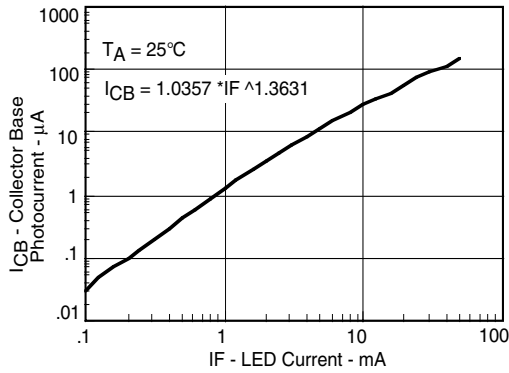

#250_09

Figure 9. Collector-Base Photocurrent vs. LED Current

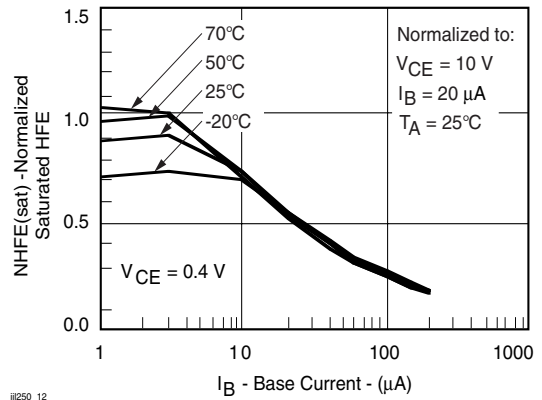

#250_12

Figure 12. Normalized Saturated HFE vs. Base Current and Temperature

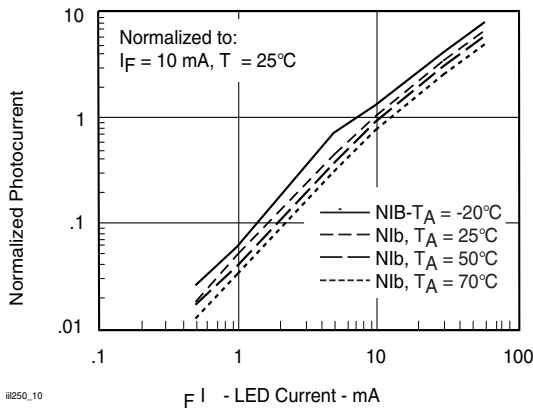

#250_10

Figure 10. Normalized Photocurrent vs. I_F and Temp.

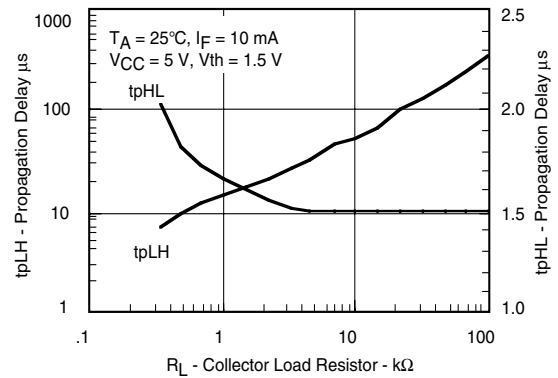

#250_13

Figure 13. Propagation Delay vs. Collector Load Resistor

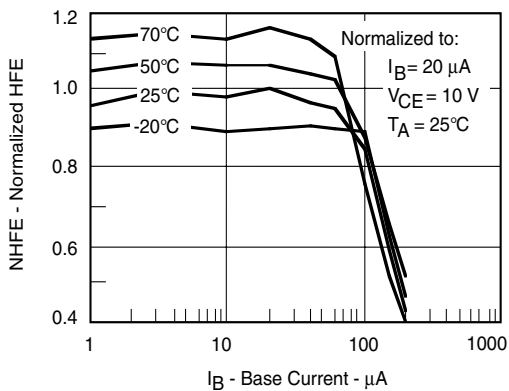

#250_11

Figure 11. Normalized Non-saturated HFE vs. Base Current and Temperature

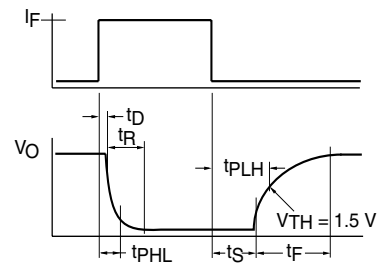

#250_14

Figure 14. Switching Timing

Figure 15. Switching Schematic

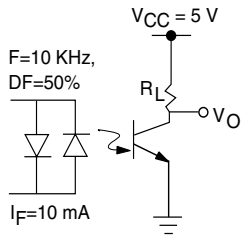

il250_15

Package Dimensions in Inches (mm)

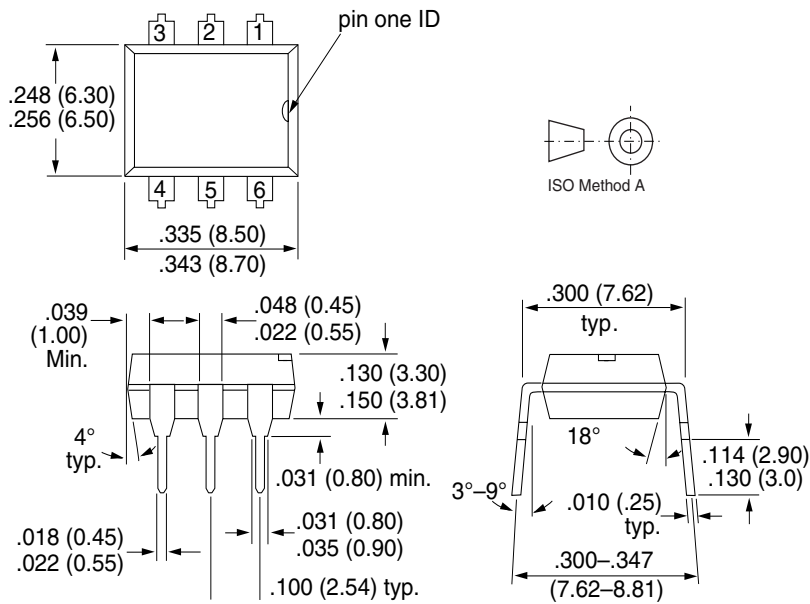



Package Dimensions in Inches (mm)

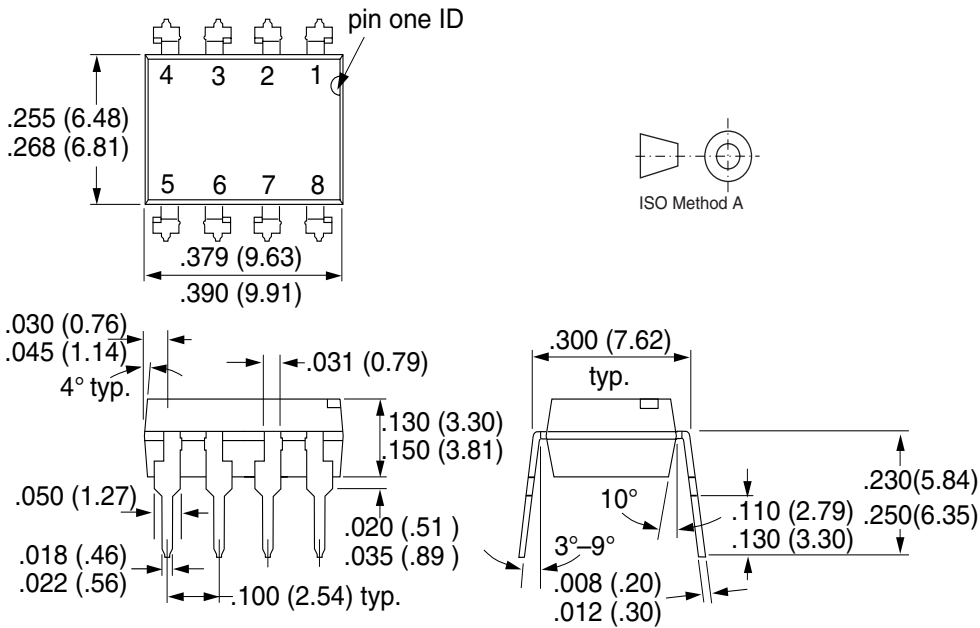

i178006

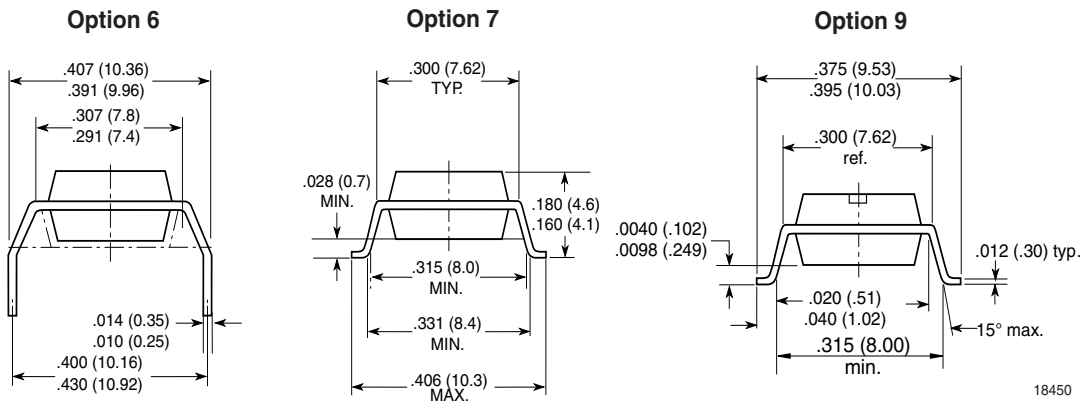

18450

Ozone Depleting Substances Policy Statement

It is the policy of Vishay Semiconductor GmbH to

1. Meet all present and future national and international statutory requirements.
2. Regularly and continuously improve the performance of our products, processes, distribution and operating systems with respect to their impact on the health and safety of our employees and the public, as well as their impact on the environment.

It is particular concern to control or eliminate releases of those substances into the atmosphere which are known as ozone depleting substances (ODSs).

The Montreal Protocol (1987) and its London Amendments (1990) intend to severely restrict the use of ODSs and forbid their use within the next ten years. Various national and international initiatives are pressing for an earlier ban on these substances.

Vishay Semiconductor GmbH has been able to use its policy of continuous improvements to eliminate the use of ODSs listed in the following documents.

1. Annex A, B and list of transitional substances of the Montreal Protocol and the London Amendments respectively
2. Class I and II ozone depleting substances in the Clean Air Act Amendments of 1990 by the Environmental Protection Agency (EPA) in the USA
3. Council Decision 88/540/EEC and 91/690/EEC Annex A, B and C (transitional substances) respectively.

Vishay Semiconductor GmbH can certify that our semiconductors are not manufactured with ozone depleting substances and do not contain such substances.

We reserve the right to make changes to improve technical design
and may do so without further notice.

Parameters can vary in different applications. All operating parameters must be validated for each customer application by the customer. Should the buyer use Vishay Semiconductors products for any unintended or unauthorized application, the buyer shall indemnify Vishay Semiconductors against all claims, costs, damages, and expenses, arising out of, directly or indirectly, any claim of personal damage, injury or death associated with such unintended or unauthorized use.

Vishay Semiconductor GmbH, P.O.B. 3535, D-74025 Heilbronn, Germany
Telephone: 49 (0)7131 67 2831, Fax number: 49 (0)7131 67 2423