

PLEASE CHECK WWW.MOLEX.COM FOR LATEST PART INFORMATION

Part Number: [0197084011](#)
Status: **Active**
Description: PCB Tab Quick Disconnect, Male, for Wire, Box, Tab 4.75mm (.187") x 0.81mm (.032")

Documents:

[Drawing \(PDF\)](#) [RoHS Certificate of Compliance \(PDF\)](#)
[Product Specification PS-19708-001 \(PDF\)](#)

Agency Certification

UL E79133

General

Product Family Quick Disconnects
 Series [19708](#)
 Crimp Quality Equipment Yes
 Product Name PCB Tab
 Type Quick Disconnect

Physical

Barrel Type N/A
 Gender Male
 Glow-Wire Compliant No
 Insulation None
 Lock to Mating Part None
 Material - Metal Brass
 Orientation PCB Straight Tab
 Packaging Type Bag
 Polarized to Mating Part No
 Tab Thickness 0.81mm (.032")
 Tab Width 4.75mm (.187")
 Wire Insulation Diameter N/A
 Wire Size AWG N/A

Electrical

Voltage - Maximum N/A

Material Info

Old Part Number 1640-3020

Reference - Drawing Numbers

Product Specification PS-19708-001
 Sales Drawing SD-19708-400

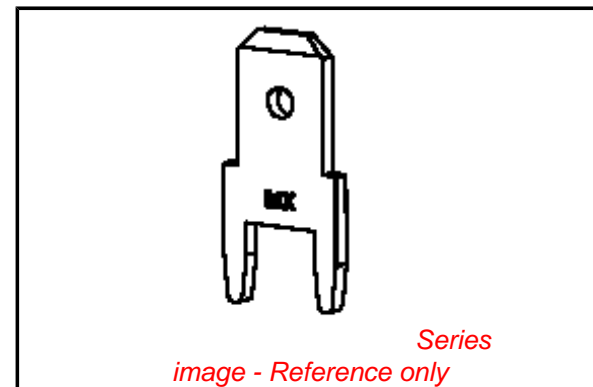

EU RoHS

**ELV and RoHS
Compliant**
REACH SVHC
 Not Reviewed
**Halogen-Free
Status**

China RoHS



**Need more information on product
environmental compliance?**

Email productcompliance@molex.com
 For a multiple part number RoHS Certificate of
 Compliance, [click here](#)

Please visit the [Contact Us](#) section for any
 non-product compliance questions.

Search Parts in this Series
[19708Series](#)

MATERIAL NUMBER	ENGINEERING NUMBER	CARRIER	TAB THICKNESS	LOGO ORIENTATION
197084003	19708-4003	STRIP	.020/0.51	IN
197084013	19708-4013	STRIP	.032/0.81	
197084015	19708-4015	STRIP	.032/0.81	
197084001	19708-4001	LOOSE	.020/0.51	-
197084011	19708-4011	LOOSE	.032/0.81	-

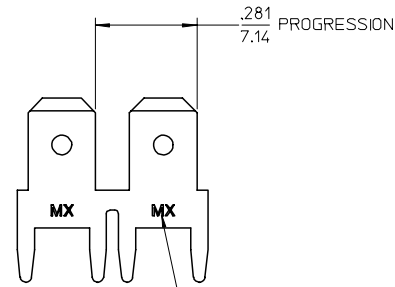
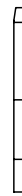
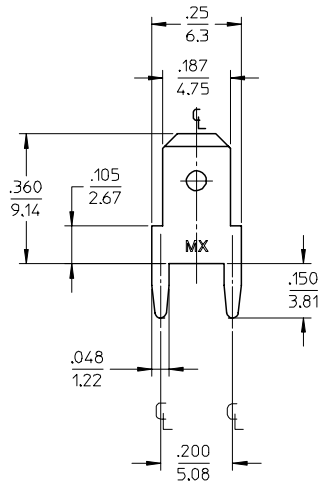
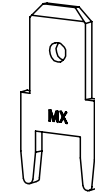

LOGO OPTIONS:
MX, ETC. OR MX-ETC

RECOMMENDED PCB
HOLE LAYOUT

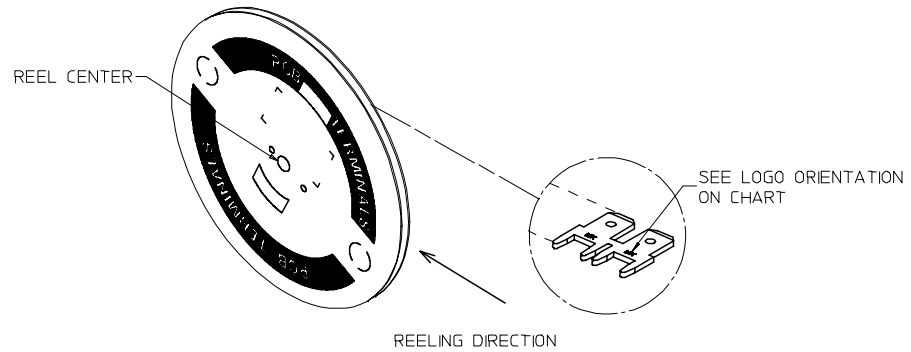
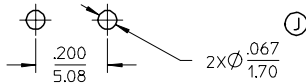

NOTES:

1. BARE EDGES PERMISSIBLE AT CARRIER CUT OFF.
2. MATERIAL: BRASS C26000
3. MATERIAL THICKNESS: SEE CHART
4. TAB CONFORMS TO NEMA SPECIFICATIONS.
5. ALL DIMENSIONS AND NOTES REFERENCE UNLESS OTHERWISE NOTED.
6. PLATING: MATTE TIN, 150μIN/3.81μmm MINIMUM THICKNESS OVER NICKEL 50μIN/1.25μmm MINIMUM THICKNESS.
7. REF.: 15,000 MINIMUM PARTS PER REEL, REEL HAS 14" DIAMETER REEL WITH A 1.25" DIAMETER CENTER HOLE.
8. PART IS ROHS COMPLIANT.

ADD LOOSE PC - REV PCB HOLE EC NO: ETC2007-0403 DRAWN BY: DRWNEHLE CHKD: JMAGNELL APPR: JMAGNELL 2007/05/14 2007/05/14 2007/05/15	QUALITY SYMBOLS ▽=0 ▽=0	GENERAL TOLERANCES (UNLESS SPECIFIED)		DIMENSION STYLE IN/MM		SCALE 4:1	DESIGN UNITS INCH	THIRD ANGLE PROJECTION			
		4 PLACES ± .005 ± .005	3 PLACES ± .005 ± .005	2 PLACES ± 0.13 ± .01	1 PLACE ± 0.25 ± .01	DRAWN BY JH	DATE 10/18/96	QUICK DISCONNECT PCB MOUNTABLE .187 X .032/.020 TAB			
		ANGULAR ± 1 °				CHECKED BY RWD	DATE 10/18/96				
		DRAFT WHERE APPLICABLE MUST REMAIN WITHIN DIMENSIONS				SEE CHART		APPROVED BY RWD	DATE 10/18/96	MOLEX INCORPORATED MATERIAL NO. SD-19708-400 DOCUMENT NO.	