

DATA SHEET

PM87/70
PM cores

Supersedes data of September 2004

2008 Sep 01

CORE SETS

Effective core parameters

SYMBOL	PARAMETER	VALUE	UNIT
$\Sigma(l/A)$	core factor (C1)	0.161	mm ⁻¹
V_e	effective volume	133000	mm ³
l_e	effective length	146	mm
A_e	effective area	910	mm ²
A_{min}	minimum area	700	mm ²
m	mass of set	≈ 770	g

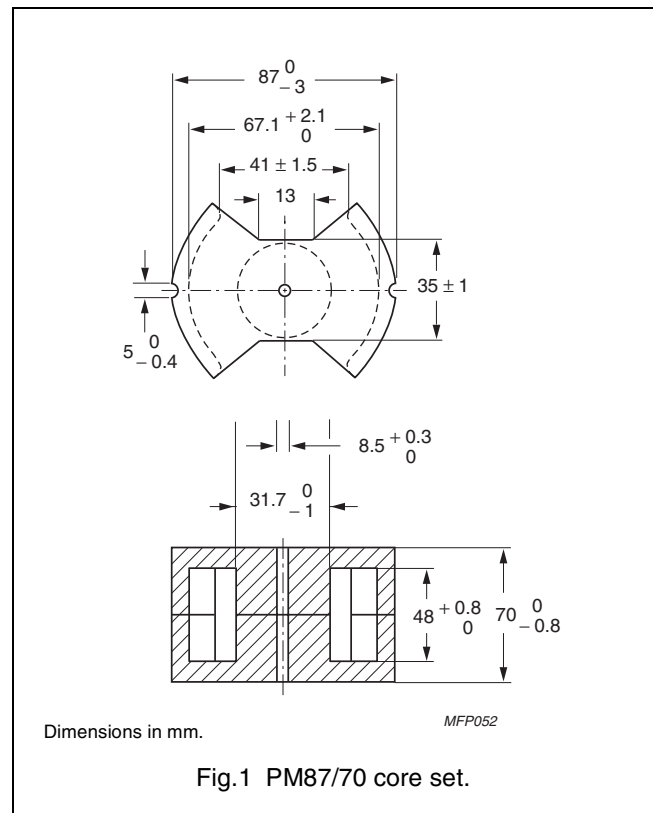

Core sets for general purpose transformers and power applications

Clamping force for A_L measurements, 1250 ± 250 N.

GRADE	A_L (nH)	μ_e	AIR GAP (μm)	TYPE NUMBER
3C90	15000 ± 25 %	≈ 1770	≈ 0	PM87/70-3C90
3C94	15000 ± 25 %	≈ 1770	≈ 0	PM87/70-3C94

Properties of core sets under power conditions

GRADE	B (mT) at	CORE LOSS (W) at
	H = 250 A/m; f = 25 kHz; T = 100 °C	f = 25 kHz; B = 200 mT; T = 100 °C
3C90	≥ 320	≤ 20
3C94	≥ 315	≤ 16



DATA SHEET STATUS DEFINITIONS

DATA SHEET STATUS	PRODUCT STATUS	DEFINITIONS
Preliminary specification	Development	This data sheet contains preliminary data. Ferroxcube reserves the right to make changes at any time without notice in order to improve design and supply the best possible product.
Product specification	Production	This data sheet contains final specifications. Ferroxcube reserves the right to make changes at any time without notice in order to improve design and supply the best possible product.

DISCLAIMER

Life support applications — These products are not designed for use in life support appliances, devices, or systems where malfunction of these products can reasonably be expected to result in personal injury. Ferroxcube customers using or selling these products for use in such applications do so at their own risk and agree to fully indemnify Ferroxcube for any damages resulting from such application.

PRODUCT STATUS DEFINITIONS

STATUS	INDICATION	DEFINITION
Prototype		These are products that have been made as development samples for the purposes of technical evaluation only. The data for these types is provisional and is subject to change.
Design-in		These products are recommended for new designs.
Preferred		These products are recommended for use in current designs and are available via our sales channels.
Support		These products are not recommended for new designs and may not be available through all of our sales channels. Customers are advised to check for availability.