

DataSheet4U.com

DataShee

## Metal Oxide Varistors Transient/Surge Absorbers



**Transient/Surge Absorbers  
Transient Voltage Surge Suppressors**

**CeNtRa Varistor**

Varistor are voltage dependent, nonlinear device which have an electrical behavior similar to back-to-back zender diodes. CNR series zinc oxide varistor are nonlinear resistors, consisting main of zinc oxide and several kinds of metal oxide additive. They are bilateral and symmetrical V-I characteristics curve and unparalleled large peak current capability are used for absorption of transient voltage, suppression of pulse noise and circuit voltage stabilization.

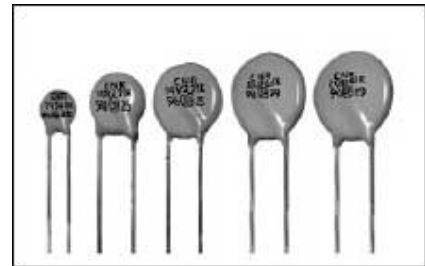

**Features**

- Fast response
- Excellent voltage ratio
- High stabilization for circuit voltage
- Unparalleled absorption for transient voltage characteristics
- Bilateral and symmetrical V-I characteristics curve

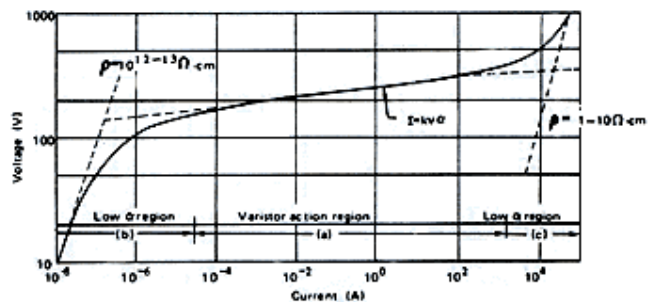

Typical Varistor V - I Curve

**Applications**

- Surge Protection in consumer electronics
  - industrial electronics
  - telephone and telecommunication systems
  - automobile equipments
  - measuring and controller systems
  - electronic home appliances
- Absorption of switching surge form various kinds of relays and electro-magnetic valves.
- Electrostatic discharge an spike noise suppression.
- Protection of various kinds of transistors, diodes, ICs, thyristors, triac semiconductors, and etc.

**Related Standards**

- UL1414, UL1449, (2<sup>nd</sup> Edition), CSA, VDE

Explanation of Part Numbers

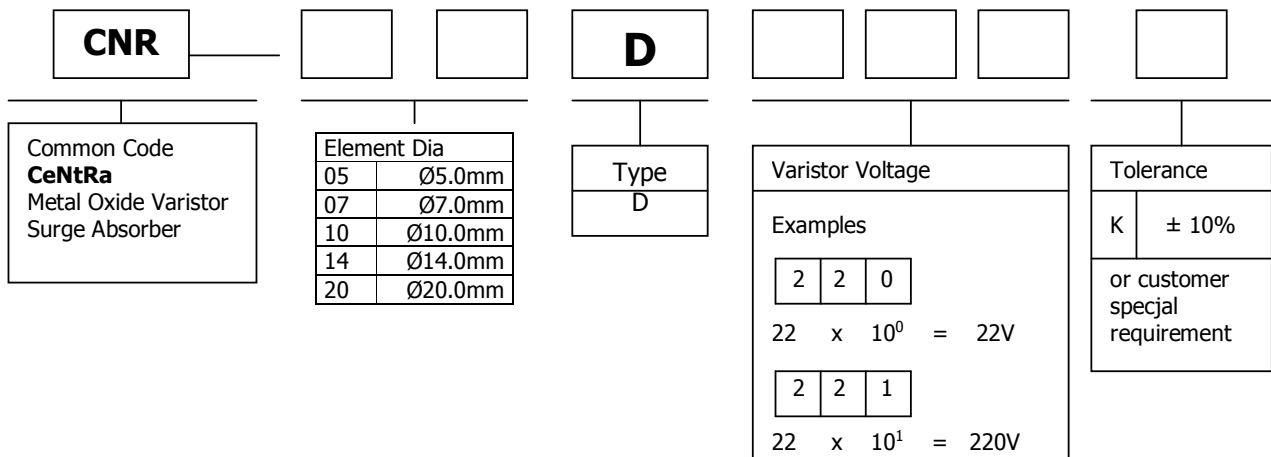



## Transient/Surge Absorbers Transient Voltage Surge Suppressors

### Specifications

- Varistor Voltage Range .....18 TO 1800Vdc
- Peak Current For 8/20  $\mu$ s Current Wave.....100 TO 6500A
- Energy Range For 10/1000  $\mu$ s Current Wave..... 0.4 TO 625 Joule
- Storage Temperature Range .....-40 TO +125°C
- Operation Ambient Temperature Range .....- 40 TO 85°C
- Typical Response Time .....< 25ns
- Insulation Resistance .....>1000M $\Omega$

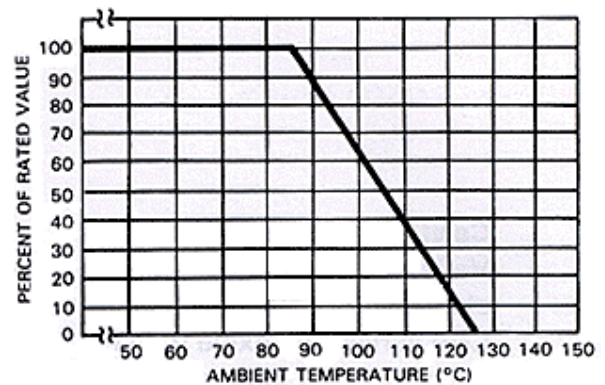

Current, Energy and Power Derating Curve

### Device Ratings and Characteristics

Part No.	Maximum Allowable Voltage		Varistor Voltage (@1mA)			Clamping Voltage @ Test Current (8/20 $\mu$ s)		Maximum Energy 10/1000 $\mu$ s (J)	Maximum Peak Current (8/20 $\mu$ s) (A)	Rated Power (W)	Typical Capacitance (@1KHz) (pF)	Standards
	ACrms(V)	DC(V)	Min.	Vb(Vdc)	Max.	Vc(V)	Ip(A)					
CNR-05D180K	11	14	14.4	18	21.6	44	1	0.4	100	0.01	1600	☆
CNR-07D180K						42	2.5	0.9	250	0.02	3800	☆
CNR-10D180K						39	5	2.1	500	0.05	16000	☆
CNR-14D180K						39	10	4.0	1000	0.10	25000	☆
CNR-20D180K						39	20	11.0	2000	0.20	40000	☆
CNR-05D220K	14	18	18.7	22	26.0	51	1	0.5	100	0.01	1500	☆
CNR-07D220K						47	2.5	1.1	250	0.02	3600	☆
CNR-10D220K						43	5	2.5	500	0.05	11000	☆
CNR-14D220K						43	10	5.0	1000	0.10	20000	☆
CNR-20D220K						43	20	14.0	2000	0.20	30000	☆
CNR-05D270K	17	22	23.0	27	31.1	60	1	0.6	100	0.01	1450	☆
CNR-07D270K						53	2.5	1.4	250	0.02	3400	☆
CNR-10D270K						53	5	3.0	500	0.05	8000	☆
CNR-14D270K						53	10	6.0	1000	0.10	16000	☆
CNR-20D270K						53	20	18.0	2000	0.20	24500	☆
CNR-05D330K	20	26	29.5	33	36.5	73	1	0.8	100	0.01	1400	☆
CNR-07D330K						65	2.5	1.7	250	0.02	2900	☆
CNR-10D330K						65	5	4.0	500	0.05	6300	☆
CNR-14D330K						65	10	7.5	1000	0.10	12200	☆
CNR-20D330K						65	20	23.0	2000	0.20	20000	☆
CNR-05D390K	25	31	35	39	46	86	1	0.9	100	0.01	700	☆
CNR-07D390K					43	77	2.5	2.1	250	0.02	1600	☆
CNR-10D390K					43	77	5	4.6	500	0.05	5200	☆
CNR-14D390K					43	77	10	8.6	1000	0.10	7000	☆
CNR-20D390K					43	77	20	26.0	2000	0.20	13800	☆
CNR-05D470K	30	38	42	47	55	104	1	1.1	100	0.01	650	☆
CNR-07D470K					52	93	2.5	2.5	250	0.02	1550	☆
CNR-10D470K					52	93	5	5.5	500	0.05	4600	☆
CNR-14D470K					52	93	10	10.0	1000	0.10	6750	☆
CNR-20D470K					52	93	20	33.0	2000	0.20	13500	☆

Note: 1. O5D series Varistor voltage test current by Dc 0.1 mA



## Transient/Surge Absorbers Transient Voltage Surge Suppressors

### Device Ratings and Characteristics

Part No.	Maximum Allowable Voltage		Varistor Voltage (@1mA)			Clamping Voltage @ Test Current (8/20 $\mu$ s)		Maximum Energy 10/1000 $\mu$ s (J)	Maximum Peak Current (8/20 $\mu$ s) (A)	Rated Power (W)	Typical Capacitance (@1KHz) (pF)	Standards
CNR-05D560K	35	45	50	56	66	123	1	1.3	100	0.01	600	☆
CNR-07D560K					62	110	2.5	3.1	250	0.02	1500	☆
CNR-10D560K					62	110	5	7.0	500	0.05	3750	☆
CNR-14D560K					62	110	10	11.0	1000	0.10	6500	☆
CNR-20D560K					62	110	20	41.0	2000	0.20	12200	☆
CNR-05D680K	40	56	61	68	80	150	1	1.6	100	0.01	580	☆
CNR-07D680K					75	135	2.5	3.6	250	0.02	1200	☆
CNR-10D680K					75	135	5	8.2	500	0.05	2800	☆
CNR-14D680K					75	135	10	14.0	1000	0.10	5500	☆
CNR-20D680K					75	135	20	46.0	2000	0.20	11500	☆
CNR-05D820K	50	65	74	82	90	145	5	2.5	400	0.10	310	☆ ◎
CNR-07D820K						135	10	5.5	1200	0.25	860	☆ ◎
CNR-10D820K						135	25	12.0	2500	0.40	1920	☆ ◎
CNR-14D820K						135	50	22.0	4500	0.60	4300	☆ ◎
CNR-20D820K						135	100	38.0	6500	1.0	8200	☆ ◎
CNR-05D101K	60	85	90	100	110	175	5	3.0	400	0.10	290	☆ ◎
CNR-07D101K						165	10	6.5	1200	0.25	750	☆ ◎
CNR-10D101K						165	25	15.0	2500	0.40	1800	☆ ◎
CNR-14D101K						165	50	28.0	4500	0.60	3500	☆ ◎
CNR-20D101K						165	100	45.0	6500	1.0	8000	☆ ◎
CNR-05D121K	75	100	108	120	132	210	5	4.0	400	0.10	270	☆ ◎
CNR-07D121K						200	10	7.8	1200	0.25	530	☆ ◎
CNR-10D121K						200	25	18.0	2500	0.40	1500	☆ ◎
CNR-14D121K						200	50	32.0	4500	0.60	2500	☆ ◎
CNR-20D121K						200	100	55.0	6500	1.0	5500	☆ ◎
CNR-05D151K	95	125	135	150	165	260	5	4.8	400	0.10	240	☆ ◎
CNR-07D151K						250	10	9.7	1200	0.25	410	☆ ◎
CNR-10D151K						250	25	22.0	2500	0.40	1200	☆ ◎
CNR-14D151K						250	50	40.0	4500	0.60	2100	☆ ◎
CNR-20D151K						250	100	70.0	6500	1.0	4200	☆ ◎
CNR-05D181K	115	150	162	180	198	325	5	5.9	400	0.10	140	☆ ◎
CNR-07D181K						300	10	11.7	1200	0.25	300	☆ ◎
CNR-10D181K						300	25	27.0	2500	0.40	620	☆ ◎
CNR-14D181K						300	50	50.0	4500	0.60	1250	☆ ◎
CNR-20D181K						300	100	85.0	6500	1.0	2500	☆ ◎
CNR-05D201K	130	170	185	200	225	355	5	6.5	400	0.10	120	△ ☆ ※ ◎
CNR-07D201K						340	10	13.0	1200	0.25	250	△ ☆ ※ ◎
CNR-10D201K						340	25	30.0	2500	0.40	570	△ ☆ ※ ◎
CNR-14D201K						340	50	57.0	4500	0.60	1150	△ ☆ ※ ◎
CNR-20D201K						340	100	95.0	6500	1.0	2300	△ ☆ ※ ◎

Note: 1. O5D series Varistor voltage test current by Dc 0.1 mA



## Transient/Surge Absorbers Transient Voltage Surge Suppressors

### Device Ratings and Characteristics

Part No.	Maximum Allowable Voltage		Varistor Voltage (@1mA)			Clamping Voltage @ Test Current (8/20 $\mu$ s)		Maximum Energy 10/1000 $\mu$ s (J)	Maximum Peak Current (8/20 $\mu$ s) (A)	Rated Power (W)	Typical Capacitance (@1KHz) (pF)	Standards
CNR-05D221K	140	180	198	220	242	380	5	7.0	400	0.10	110	$\Delta$ ☆ ※ ◎
CNR-07D221K						360	10	14.0	1200	0.25	250	$\Delta$ ☆ ※ ◎
CNR-10D221K						360	25	32.0	2500	0.40	560	$\Delta$ ☆ ※ ◎
CNR-14D221K						360	50	60.0	4500	0.60	1100	$\Delta$ ☆ ※ ◎
CNR-20D221K						360	100	100.0	6500	1.0	2200	$\Delta$ ☆ ※ ◎
CNR-05D241K	150	200	216	240	264	415	5	8.0	400	0.10	110	$\Delta$ ☆ ※ ◎
CNR-07D241K						395	10	15.0	1200	0.25	240	$\Delta$ ☆ ※ ◎
CNR-10D241K						395	25	35.0	2500	0.40	550	$\Delta$ ☆ ※ ◎
CNR-14D241K						395	50	63.0	4500	0.60	1050	$\Delta$ ☆ ※ ◎
CNR-20D241K						395	100	108.0	6500	1.0	2200	$\Delta$ ☆ ※ ◎
CNR-05D271K	175	225	247	270	303	475	5	8.5	400	0.10	100	$\Delta$ ☆ ※ ◎
CNR-07D271K						455	10	18.0	1200	0.25	220	$\Delta$ ☆ ※ ◎
CNR-10D271K						455	25	40.0	2500	0.40	530	$\Delta$ ☆ ※ ◎
CNR-14D271K						455	50	70.0	4500	0.60	1000	$\Delta$ ☆ ※ ◎
CNR-20D271K						455	100	127.0	6500	1.0	2100	$\Delta$ ☆ ※ ◎
CNR-05D301K	195	250	270	300	330	505	5	9.0	400	0.10	100	$\Delta$ ☆ ※ ◎
CNR-07D301K						500	10	20.0	1200	0.25	190	$\Delta$ ☆ ※ ◎
CNR-10D301K						500	25	42.0	2500	0.40	500	$\Delta$ ☆ ※ ◎
CNR-14D301K						500	50	73.0	4500	0.60	900	$\Delta$ ☆ ※ ◎
CNR-20D301K						500	100	150.0	6500	1.0	1800	$\Delta$ ☆ ※ ◎
CNR-05D331K	210	275	297	330	363	600	5	10.0	400	0.10	90	$\Delta$ ☆ ※ ◎
CNR-07D331K						550	10	25.0	1200	0.25	180	$\Delta$ ☆ ※ ◎
CNR-10D331K						550	25	47.0	2500	0.40	450	$\Delta$ ☆ ※ ◎
CNR-14D331K						550	50	93.0	4500	0.60	850	$\Delta$ ☆ ※ ◎
CNR-20D331K						550	100	163.0	6500	1.0	1750	$\Delta$ ☆ ※ ◎
CNR-05D361K	230	230	324	360	396	320	5	10.0	400	0.10	80	$\Delta$ ☆ ※ ◎
CNR-07D361K						595	10	25.0	1200	0.25	170	$\Delta$ ☆ ※ ◎
CNR-10D361K						595	25	47.0	2500	0.40	450	$\Delta$ ☆ ※ ◎
CNR-14D361K						595	50	93.0	4500	0.60	800	$\Delta$ ☆ ※ ◎
CNR-20D361K						595	100	163.0	6500	1.0	1700	$\Delta$ ☆ ※ ◎
CNR-05D391K	250	320	351	390	429	675	5	12.0	400	0.10	80	$\Delta$ ☆ ※ ◎
CNR-07D391K						650	10	25.0	1200	0.25	160	$\Delta$ ☆ ※ ◎
CNR-10D391K						650	25	60.0	2500	0.40	430	$\Delta$ ☆ ※ ◎
CNR-14D391K						650	50	100.0	4500	0.60	800	$\Delta$ ☆ ※ ◎
CNR-20D391K						650	100	180.0	6500	1.0	1400	$\Delta$ ☆ ※ ◎
CNR-05D431K	275	350	387	430	473	745	5	13.0	400	0.10	70	$\Delta$ ☆ ※ ◎
CNR-07D431K						710	10	28.0	1200	0.25	150	$\Delta$ ☆ ※ ◎
CNR-10D431K						710	25	65.0	2500	0.40	400	$\Delta$ ☆ ※ ◎
CNR-14D431K						710	50	115.0	4500	0.60	650	$\Delta$ ☆ ※ ◎
CNR-20D431K						710	100	190.0	6500	1.0	1350	$\Delta$ ☆ ※ ◎

Note: 1. O5D series Varistor voltage test current by Dc 0.1 mA



## Transient/Surge Absorbers Transient Voltage Surge Suppressors

### Device Ratings and Characteristics

Part No.	Maximum Allowable Voltage		Varistor Voltage (@1mA)			Clamping Voltage @ Test Current (8/20 $\mu$ s)		Maximum Energy 10/1000 $\mu$ s (J)	Maximum Peak Current (8/20 $\mu$ s) (A)	Rated Power (W)	Typical Capacitance (@1KHz) (pF)	Standards
CNR-05D471K	300	385	423	470	517	810	5	15.0	400	0.10	70	$\Delta$ ☆ ※ ◎
CNR-07D471K						775	10	30.0	1200	0.25	130	$\Delta$ ☆ ※ ◎
CNR-10D471K						775	25	70.0	2500	0.40	300	$\Delta$ ☆ ※ ◎
CNR-14D471K						775	50	125.0	4500	0.60	550	$\Delta$ ☆ ※ ◎
CNR-20D471K						775	100	220.0	6500	1.0	1200	$\Delta$ ☆ ※ ◎
CNR-05D511K	320	410	459	510	561	880	5	15.0	400	0.10	65	$\Delta$ ☆ ※ ◎
CNR-07D511K						845	10	30.0	1200	0.25	120	$\Delta$ ☆ ※ ◎
CNR-10D511K						845	25	70.0	2500	0.40	260	$\Delta$ ☆ ※ ◎
CNR-14D511K						845	50	125.0	4500	0.60	450	$\Delta$ ☆ ※ ◎
CNR-20D511K						845	100	220.0	6500	1.0	1050	$\Delta$ ☆ ※ ◎
CNR-05D561K	350	460	504	560	616	940	5	15.0	400	0.10	65	$\Delta$ ☆ ※ ◎
CNR-07D561K						915	10	30.0	1200	0.25	120	$\Delta$ ☆ ※ ◎
CNR-10D561K						915	25	70.0	2500	0.40	200	$\Delta$ ☆ ※ ◎
CNR-14D561K						915	50	125.0	4500	0.60	400	$\Delta$ ☆ ※ ◎
CNR-20D561K						915	100	220.0	6500	1.0	850	$\Delta$ ☆ ※ ◎
CNR-05D621K	385	505	558	620	682	1050	5	15.0	400	0.10	65	$\Delta$ ☆ ※ ◎
CNR-07D621K						1025	10	30.0	1200	0.25	120	$\Delta$ ☆ ※ ◎
CNR-10D621K						1025	25	70.0	2500	0.40	170	$\Delta$ ☆ ※ ◎
CNR-14D621K						1025	50	125.0	4500	0.60	350	$\Delta$ ☆ ※ ◎
CNR-20D621K						1025	100	220.0	6500	1.0	570	$\Delta$ ☆ ※ ◎
CNR-05D681K	420	560	612	680	748	1150	5	15.0	400	0.10	60	※ ◎
CNR-07D681K						1120	10	30.0	1200	0.25	110	$\Delta$ ☆ ※ ◎
CNR-10D681K						1120	25	70.0	2500	0.40	160	$\Delta$ ☆ ※ ◎
CNR-14D681K						1120	50	130.0	4500	0.60	350	$\Delta$ ☆ ※ ◎
CNR-20D681K						1120	100	230.0	6500	1.0	550	$\Delta$ ☆ ※ ◎
CNR-05D751K	460	615	675	750	825	1290	5	15.0	400	0.10	60	※ ◎
CNR-07D751K						1240	10	33.0	1200	0.25	100	$\Delta$ ☆ ※ ◎
CNR-10D751K						1240	25	75.0	2500	0.40	150	$\Delta$ ☆ ※ ◎
CNR-14D751K						1240	50	143.0	4500	0.60	330	$\Delta$ ☆ ※ ◎
CNR-20D751K						1240	100	255.0	6500	1.0	530	$\Delta$ ☆ ※ ◎
CNR-07D781K	485	640	702	780	858	1290	10	37.0	1200	0.25	90	$\Delta$ ☆ ※ ◎
CNR-10D781K						1290	25	80.0	2500	0.40	150	$\Delta$ ☆ ※ ◎
CNR-14D781K						1290	50	148.0	4500	0.60	330	$\Delta$ ☆ ※ ◎
CNR-20D781K						1290	100	265.0	6500	1.0	500	$\Delta$ ☆ ※ ◎
CNR-07D821K	510	670	738	820	902	1355	10	40.0	1200	0.25	90	$\Delta$ ☆ ※ ◎
CNR-10D821K						1355	25	85.0	2500	0.40	150	$\Delta$ ☆ ※ ◎
CNR-14D821K						1355	50	157.0	4500	0.60	330	$\Delta$ ☆ ※ ◎
CNR-20D821K						1355	100	282.0	6500	1.0	500	$\Delta$ ☆ ※ ◎
CNR-10D911K	550	745	819	910	1001	1500	25	93.0	2500	0.40	140	$\Delta$ ☆ ※ ◎
CNR-14D911K						1500	50	175.0	4500	0.60	300	$\Delta$ ☆ ※ ◎
CNR-20D911K						1500	100	310.0	6500	1.0	480	$\Delta$ ☆ ※ ◎

Note: 1. O5D series Varistor voltage test current by Dc 0.1 mA

www.DataSheet4U.com



## Transient/Surge Absorbers Transient Voltage Surge Suppressors

### Device Ratings and Characteristics

Part No.	Maximum Allowable Voltage		Varistor Voltage (@1mA)			Clamping Voltage @ Test Current (8/20 $\mu$ s)		Maximum Energy 10/1000 $\mu$ s	Maximum Peak Current (8/20 $\mu$ s)	Rated Power	Typical Capacitance (@1KHz)	Standards
CNR-10D102K	625	825	900	1000	1100	1650	25	102.0	2500	0.40	140	$\Delta$ ☆ ※ $\odot$
CNR-14D102K						1650	50	190.0	4500	0.60	300	$\Delta$ ☆ ※ $\odot$
CNR-20D102K						1650	100	342.0	6500	1.0	460	$\Delta$ ☆ ※ $\odot$
CNR-10D112K	680	895	990	1100	1210	1815	25	115.0	2500	0.40	130	※ $\odot$
CNR-14D112K						1815	50	213.0	4500	0.60	200	※ $\odot$
CNR-20D112K						1815	100	383.0	6500	1.0	400	※ $\odot$
CNR-14D182K	1000	1465	1620	1800	1980	2970	50	337.0	4500	0.60	150	
CNR-20D182K						2970	100	625.0	6500	1.0	250	

Note: 1. O5D series Varistor voltage test current by Dc 0.1 mA

### Application Notes for UL Recognized Components

#### Related Standards

Standard No.	UL 1414	UL 1449(2nd Edition)	CSA	VDE
Title	Across-The-Line Components	Transient Voltage Surge Suppressors	Accessories and Parts for Electronic Products	Varistors for use in Electronic equipment
File No.	E165143	E150709	LR109736-1	21557-4790-001
Symbols	$\Delta$	☆	※	$\odot$

### Selection guide

1. Determine the necessary steady-state voltage (working voltage).
2. Establish the transient energy absorbed by the varistor.
3. Calculate the peak transient current through the varistor.
4. Determine power dissipation requirement.
5. Select a model to provide the required voltage-clamping characteristics.

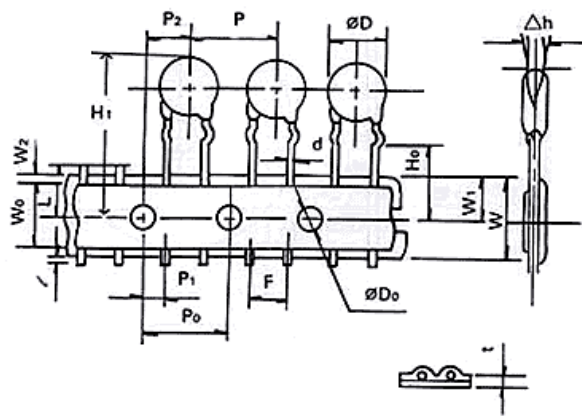
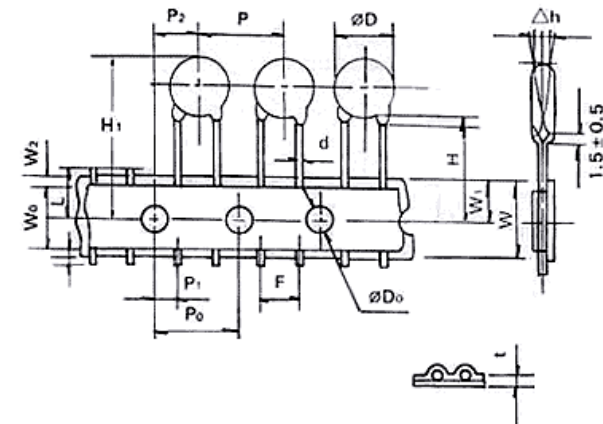
**Tape and Reel Specifications**
**1. Crimped Leads**

**2. Straight Leads**

Symbol	PARAMETER	Series			
		05D	07D	10D	14D
P	Pitch of Component	12.7±1.0	12.7±1.0	12.7±1.0	25.4±1.0
P <sub>0</sub>	Feed Hole Pitch	12.7±0.2	12.7±0.2	12.7±0.2	12.7±0.2
P <sub>1</sub>	Feed Hole Center to Lead	3.85±0.7	3.85±0.7	2.6±0.7	2.6±0.7
P <sub>2</sub>	Hole Center to Component Center	6.35±0.7	6.35±0.7	6.35±0.7	6.35±0.7
F	Lead to Lead Distance	5.0±0.8	5.0±0.8	7.50±0.8	7.50±0.8
Δh	Component Alignment	2.0 Max	2.0 Max	2.0 Max	2.0 Max
W	Tape Width	18.0+1.0 18.0-0.5	18.0+1.0 18.0-0.5	18.0+1.0 18.0-0.5	18.0+1.0 18.0-0.5
W <sub>0</sub>	Hold Down Tape Width	16.0±0.3	16.0±0.3	16.0±0.3	16.0±0.3
W <sub>1</sub>	Hole Position	9.0+0.75 9.0-0.50	9.0+0.75 9.0-0.50	9.0+0.75 9.0-0.50	9.0+0.75 9.0-0.50
W <sub>2</sub>	Hold Down Tape Position	0.5 Max	0.5 Max	0.5 Max	0.5 Max
H	Height from Tape Center to Component Base	18.0+2.0 18.0-0.0	18.0+2.0 18.0-0.0	18.0+2.0 18.0-0.0	18.0+2.0 18.0-0.0
H <sub>0</sub>	Seating Plane Height	16.0±0.5	16.0±0.5	16.0±0.5	16.0±0.5
H <sub>1</sub>	Component Height	29.0 Max	32.0 Max	36.0 Max	40.0 Max
D <sub>0</sub>	Feed Hole Diameter	4.0±0.2	4.0±0.2	4.0±0.2	4.0±0.2
t	Total Tape Thickness	0.7±0.2	0.7±0.2	0.7±0.2	0.7±0.2
L	Length of Clipped Lead	11.0 Max	11.0 Max	11.0 Max	11.0 Max

**Order Information of Taped Reel**

Standard Products	Tape Reel Straight Lead	Tape Reel Crimped Lead	Min. Q`ty	Q`ty / Inner Box	Q`ty / Carton
CNR-05DXXXK	CNR-05DXXXK-TRS	CNR-05DXXXK-TRK	2000/1500	4000/3000	20000/15000
CNR-07DXXXK	CNR-07DXXXK-TRS	CNR-07DXXXK-TRK	2000/1500	4000/3000	20000/15000
CNR-10DXXXK	CNR-10DXXXK-TRS	CNR-10DXXXK-TRK	1500/1000	3000/2000	15000/10000
CNR-14DXXXK	CNR-14DXXXK-TRS	CNR-14DXXXK-TRK	1000/800	2000/1600	8000/6400

**Note:**

- "2000/1500" Packing in CNR-XXD180K to CNR-XXD271K are 2000 pcs, CNR-XXD301K to CNR-XXD471K with 1500 pcs.
- Packing unit in pcs.





## Transient/Surge Absorbers Transient Voltage Surge Suppressors

### Packaging Specifications

Dimensions are in mm	Flat box				Reel				
	Symbol	5D	7D	10D	Symbol	5D	7D	10D	14D
	A	55 max.			W	Approx. 35			55
	B	330 max.			D	360 max			
C	340 max.			A	Approx. Ø 30				
				B	Approx. Ø 90				

### Order Information of Flat Box

Standard Products	Tape Box Straight Lead	Tape Box Crimped Lead	Max. Q`ty	Q`ty / Inner Box	Q`ty / Carton
CNR-05DXXXK	CNR-05DXXXK-BTS	CNR-05DXXXK-BTK	2000/1500	4000/3000	20000/15000
CNR-07DXXXK	CNR-07DXXXK-BTS	CNR-07DXXXK-BTK	2000/1500	4000/3000	20000/15000
CNR-10DXXXK	CNR-10DXXXK-BTS	CNR-10DXXXK-BTK	1500/1000	3000/2000	15000/10000

#### Note:

- "2000/1500" Packing in CNR-XXD180K to CNR-XXD271K are 2000 pcs, CNR-XXD301K to CNR-XXD471K with 1500 pcs.
- Packing unit in pcs.

Symbol		Series	05D	07D	10D	14D
A max.	Varistor Voltage V1mA(V)	18 to 270	13.0	15.0	19.5	22.5
		360 to 470	13.0	15.0	20.5	23.5
D max.			7.5	9.0	14.0	17.5
K			1.2 ± 0.4	1.2 ± 0.4	1.4 ± 0.4	1.4 ± 0.4
W			5.0 ± 1.0	5.0 ± 1.0	7.5 ± 1.0	7.5 ± 1.0
Ø d			0.6	0.6	0.8	0.8

### Crimped Leads Type

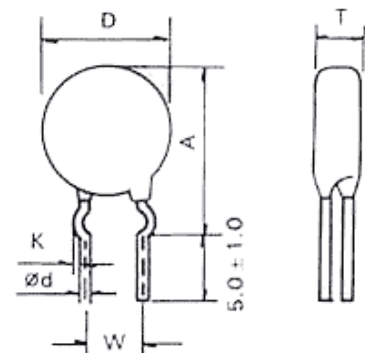

T max. see standard specification table.

### Order Information of Crimp Leads

Standard Products	Cut Off Straight Lead	Cut Off Crimped Lead	Max. Q`ty	Q`ty / Box	Q`ty / Carton
CNR-05DXXXK	CNR-05DXXXK-TTS	CNR-05DXXXK-TTK	1000	25000	50000
CNR-07DXXXK	CNR-07DXXXK-TTS	CNR-07DXXXK-TTK	1000	20000	40000
CNR-10DXXXK	CNR-10DXXXK-TTS	CNR-10DXXXK-TTK	1000	20000	40000
CNR-14DXXXK	CNR-14DXXXK-TTS	CNR-14DXXXK-TTK	1000	10000	20000

#### Note:

- Packing unit in pcs.



## Transient/Surge Absorbers Transient Voltage Surge Suppressors

### Performance Characteristics (Electrical)

Characteristics		Test Methods/Description	Specifications																												
Standard Test Condition		Environmental conditions under which every measuring is done without doubt on the measuring results. Unless specially specified, temperature, relative humidity are 5 to 35 °C, 45 to 85 % RH.	—																												
varistor Voltage		The voltage between two terminals with the specified measuring current $I_{mA}$ DC applied is called $V_c$ or $V_{cmA}$ . The measurement shall be made as fast as possible to avoid heat affection.	To meet the specified value																												
Maximum Allowable Voltage		The maximum sinusoidal RMS voltage or maximum DC voltage that can be applied continuously in the specified environmental temperature range.																													
Clamping Voltage		The maximum voltage between two terminals with the specified standard impulse current (8/20 $\mu$ s) illustrated below applied. <div style="text-align: center;"> </div>																													
Rated Power		The power that can be applied in the specified ambient temperature.																													
Maximum Energy		The maximum energy within the varistor voltage change of $\pm 10\%$ when one impulse of 2 ms or 10/1000 $\mu$ s is applied.																													
Maximum peak Current Withstanding Surge Current	2 times	The maximum current within the varistor voltage change of $\pm 10\%$ with the standard impulse current (8/20 $\mu$ s) applied two times with an interval of 5 minutes.																													
	1 time	The maximum current within the varistor voltage change of $\pm 10\%$ with the standard impulse current (8/20 $\mu$ s) applied one time.																													
Temperature Coefficient of Varistor Voltage		$\frac{V_c \text{ at } 85^\circ\text{C} - V_c \text{ at } 25^\circ\text{C}}{V_c \text{ at } 25^\circ\text{C}} \times \frac{1}{60} \times 100 (\%/^\circ\text{C})$		-0.05%/°C max																											
Capacitance																															
Dissipation Factor																															
Withstanding Voltage (Body Insulation)		The specified voltage shall be applied both terminals of the specimen connected together and metal foil closely wrapped round its body for 1 minute. Electrical breakdown shall be examined. <table border="1" style="width: 100%; margin-top: 10px;"> <thead> <tr> <th>Classification (Nominal varistor voltage)</th> <th>Test Voltage (AC)</th> </tr> </thead> <tbody> <tr> <td><math>V_{0.1mA}, V_{1mA}, \leq 330V</math></td> <td>1000Vrms</td> </tr> <tr> <td><math>V_{0.1mA}, V_{1mA}, &gt; 330V</math></td> <td>1500Vrms</td> </tr> </tbody> </table>	Classification (Nominal varistor voltage)	Test Voltage (AC)	$V_{0.1mA}, V_{1mA}, \leq 330V$	1000Vrms	$V_{0.1mA}, V_{1mA}, > 330V$	1500Vrms	No breakdown																						
Classification (Nominal varistor voltage)	Test Voltage (AC)																														
$V_{0.1mA}, V_{1mA}, \leq 330V$	1000Vrms																														
$V_{0.1mA}, V_{1mA}, > 330V$	1500Vrms																														
Impulse Life		The change of $V_c$ shall be measured after the impulse listed below is applied 10000 times continuously with the interval of 10 seconds at room temperature. <table border="1" style="width: 100%; margin-top: 10px;"> <thead> <tr> <th>Series</th> <th>Classification</th> <th>Test Voltage</th> </tr> </thead> <tbody> <tr> <td rowspan="2">5 Series</td> <td><b>CNR-05D180K to CNR-05D680K</b></td> <td>0.5A (2ms)</td> </tr> <tr> <td><b>CNR-05D820K to CNR-05D471K</b></td> <td>20A (8/20 <math>\mu</math>s)</td> </tr> <tr> <td rowspan="2">7 Series</td> <td><b>CNR-07D180K to CNR-07D680K</b></td> <td>18A (8/20 <math>\mu</math>s)</td> </tr> <tr> <td><b>CNR-07D820K to CNR-07D471K</b></td> <td>50A (8/20 <math>\mu</math>s)</td> </tr> <tr> <td rowspan="2">10 Series</td> <td><b>CNR-10D180K to CNR-10D680K</b></td> <td>50A (8/20 <math>\mu</math>s)</td> </tr> <tr> <td><b>CNR-10D820K to CNR-10D112K</b></td> <td>100A (8/20 <math>\mu</math>s)</td> </tr> <tr> <td rowspan="2">14 Series</td> <td><b>CNR-14D180K to CNR-14D680K</b></td> <td>75A (8/20 <math>\mu</math>s)</td> </tr> <tr> <td><b>CNR-14D820K to CNR-14D182K</b></td> <td>150A (8/20 <math>\mu</math>s)</td> </tr> <tr> <td rowspan="2">20 Series</td> <td><b>CNR-20D180K to CNR-20D680K</b></td> <td>120A (8/20 <math>\mu</math>s)</td> </tr> <tr> <td><b>CNR-20D820K to CNR-20D471K</b></td> <td>200A (8/20 <math>\mu</math>s)</td> </tr> </tbody> </table>	Series	Classification	Test Voltage	5 Series	<b>CNR-05D180K to CNR-05D680K</b>	0.5A (2ms)	<b>CNR-05D820K to CNR-05D471K</b>	20A (8/20 $\mu$ s)	7 Series	<b>CNR-07D180K to CNR-07D680K</b>	18A (8/20 $\mu$ s)	<b>CNR-07D820K to CNR-07D471K</b>	50A (8/20 $\mu$ s)	10 Series	<b>CNR-10D180K to CNR-10D680K</b>	50A (8/20 $\mu$ s)	<b>CNR-10D820K to CNR-10D112K</b>	100A (8/20 $\mu$ s)	14 Series	<b>CNR-14D180K to CNR-14D680K</b>	75A (8/20 $\mu$ s)	<b>CNR-14D820K to CNR-14D182K</b>	150A (8/20 $\mu$ s)	20 Series	<b>CNR-20D180K to CNR-20D680K</b>	120A (8/20 $\mu$ s)	<b>CNR-20D820K to CNR-20D471K</b>	200A (8/20 $\mu$ s)	$\Delta V_{cmA} / V_{cmA} \leq \pm 10\%$
Series	Classification	Test Voltage																													
5 Series	<b>CNR-05D180K to CNR-05D680K</b>	0.5A (2ms)																													
	<b>CNR-05D820K to CNR-05D471K</b>	20A (8/20 $\mu$ s)																													
7 Series	<b>CNR-07D180K to CNR-07D680K</b>	18A (8/20 $\mu$ s)																													
	<b>CNR-07D820K to CNR-07D471K</b>	50A (8/20 $\mu$ s)																													
10 Series	<b>CNR-10D180K to CNR-10D680K</b>	50A (8/20 $\mu$ s)																													
	<b>CNR-10D820K to CNR-10D112K</b>	100A (8/20 $\mu$ s)																													
14 Series	<b>CNR-14D180K to CNR-14D680K</b>	75A (8/20 $\mu$ s)																													
	<b>CNR-14D820K to CNR-14D182K</b>	150A (8/20 $\mu$ s)																													
20 Series	<b>CNR-20D180K to CNR-20D680K</b>	120A (8/20 $\mu$ s)																													
	<b>CNR-20D820K to CNR-20D471K</b>	200A (8/20 $\mu$ s)																													



## Transient/Surge Absorbers Transient Voltage Surge Suppressors

### Electrical

Characteristics	Test Methods/Description	Specifications	
Impulse Life (II)	The change of Vc shall be measured after the impulse listed below is applied 100000 times continuously with the interval of 10 seconds at room temperature .	$\Delta V_{cmA} / V_{cmA} \leq \pm 10\%$	
	5 Series		<b>CNR-05D180K to CNR-05D680K</b> 0.45A (2ms) <b>CNR-05D820K to CNR-05D471K</b> 14A (8/20 $\mu$ s)
	7 Series		<b>CNR-07D180K to CNR-07D680K</b> 12A (8/20 $\mu$ s) <b>CNR-07D820K to CNR-07D471K</b> 35A (8/20 $\mu$ s)
	10 Series		<b>CNR-10D180K to CNR-10D680K</b> 35A (8/20 $\mu$ s) <b>CNR-10D820K to CNR-10D112K</b> 70A (8/20 $\mu$ s)
	14 Series		<b>CNR-14D180K to CNR-14D680K</b> 45A (8/20 $\mu$ s) <b>CNR-14D820K to CNR-14D182K</b> 90A (8/20 $\mu$ s)
	20 Series		<b>CNR-20D180K to CNR-20D680K</b> 55A (8/20 $\mu$ s) <b>CNR-20D820K to CNR-20D471K</b> 100A (8/20 $\mu$ s)

Note: Varistor voltage change of forward direction shall be measured in the test of uni-pole surge life and DC load life

### (Mechanical)

Characteristics	Test Methods	Specifications
Robustness of Terminations (Tensile)	After gradually applying the force specified below and keeping the unit fixed for the seconds, the terminal shall be visually examined for any damage. <u>Terminal diameter</u> $\phi$ 0.6mm $\phi$ 0.8mm $\phi$ 1.0mm <u>Force</u> 9.8 N (1.0Kgf) 9.8 N (1.0Kgf) 19.6 N (2.0Kgf)	No outstanding damage
Robustness of Terminations (Bending)	The unit shall be secured with its terminal kept vertical and the force specified below be applied in the axial direction. The terminal shall gradually be bent by 90° in one direction, then 90° in the opposite direction, and again back to the original position, The damage of the terminal shall be visually examined. <u>Terminal diameter</u> $\phi$ 0.6mm $\phi$ 0.8mm $\phi$ 1.0mm <u>Force</u> 4.9 N (0.5Kgf) 4.9 N (0.5Kgf) 9.8 N (1.0Kgf)	
Vibration	After repeatedly applying a single harmonic vibration (amplitude: 0.75mm) double amplitude: 1.5mm with 1 minute vibration frequency cycles (10 Hz to 55 Hz to 10 Hz) to each of three perpendicular directions for 2 hours. thereafter There a f t e r, the term i n a shall be visually examined.	
Solderadilty	After dipping the terminals to a depth of approximately 3mm from the body in a soldering bath of 235 $\pm$ 5°C for 2 $\pm$ 0.5 seconds, the terminal shall be visually examined.	Approximately 95% of the term i n a l s shall be covered with solder uniformly
Resistance to Soldering Heat	After each lead shall be dipped into a solder bath having a temperature 260 $\pm$ 5°C (3 series: 2 5 0 $\pm$ 5°C ) to a point 2.0 to 2.5 mm from the body of the unit, using shieldig b o a r d (t=1.5mm), be held there for specified time (3series: 3 $\pm$ 1 s, 5 series: 5 $\pm$ 1 s and others: 10 $\pm$ 1 s) hen stored at room temperature and humidity for 1 to 2 hours. The change of Vc and mechanical damages are examined.	$\Delta V_{cmA} / V_{cmA} \leq \pm 5\%$ No outstanding damage



**Transient/ Surge Absorbers**  
**Transient Voltage Surge Suppressors**

**(Environmental)**

Characteristics	Test Methods	Specifications														
High Temperature Storage/ Dry Heat	The specimen shall be subjected to $125 \pm 2^{\circ}\text{C}$ for 1000 hours in a thermostatic bath without load and then stored at room temperature and humidity for 1 to 2 hours. Thereafter, the change of Vc shall be measured.	$\Delta V_{cmA}/V_{cmA} \leq \pm 5\%$														
Damp Heat/ Humidity (Steady State)	The specimen shall be subjected to $40 \pm 2^{\circ}\text{C}$ , 90 to 95 %RH for 1000 hours load and then stored at room temperature and humidity for one to two hours. Thereafter, the change of Vc shall be measured.															
Temperature Cycle	The temperature cycle shown below shall be repeated five times and then stored at room temperature and humidity for one to two hours. The change of Vc and mechanical damage shall be examined. <table border="1" style="margin-left: auto; margin-right: auto;"> <thead> <tr> <th>Step</th> <th>Temperature(<math>^{\circ}\text{C}</math>)</th> <th>Period (minutes)</th> </tr> </thead> <tbody> <tr> <td>1</td> <td><math>-40 \pm 3</math></td> <td><math>30 \pm 3</math></td> </tr> <tr> <td>2</td> <td>Room temperature</td> <td><math>15 \pm 3</math></td> </tr> <tr> <td>3</td> <td><math>125 \pm 2</math></td> <td><math>30 \pm 3</math></td> </tr> <tr> <td>4</td> <td>Room temperature</td> <td><math>15 \pm 3</math></td> </tr> </tbody> </table>		Step	Temperature( $^{\circ}\text{C}$ )	Period (minutes)	1	$-40 \pm 3$	$30 \pm 3$	2	Room temperature	$15 \pm 3$	3	$125 \pm 2$	$30 \pm 3$	4	Room temperature
Step	Temperature( $^{\circ}\text{C}$ )	Period (minutes)														
1	$-40 \pm 3$	$30 \pm 3$														
2	Room temperature	$15 \pm 3$														
3	$125 \pm 2$	$30 \pm 3$														
4	Room temperature	$15 \pm 3$														
High Temperature Load/ Dry Heat Load	After being continuously applied the Maximum Allowable Voltage at $85 \pm 2^{\circ}\text{C}$ for 1000 hours. The specimen shall be stored at room temperature and humidity for one to two hours. Thereafter, the change of Vc shall be measured.	$\Delta V_{cmA}/V_{cmA} \leq \pm 10\%$														
Damp Heat Load/ Humidity Load	The specimen shall be subjected to $40 \pm 2^{\circ}\text{C}$ , 90 to 95 %RH and the Maximum Allowable Voltage for 1000 hours and then stored at room temperature and humidity for one to two hours. Thereafter, the change of Vc shall be measured.	$\Delta V_{cmA}/V_{cmA} \leq \pm 10\%$														
Low Temperature Storage/Cold	The specimen shall be subjected to $-40 \pm 2^{\circ}\text{C}$ without load for 1000 hours and then stored at room temperature for one to two hours. Thereafter, the change of Vc shall be measured.	$\Delta V_{cmA}/V_{cmA} \leq \pm 5\%$														



**Impulse Life Time Rating Curves**

2 times: 5 minutes interval  
 up to 10 times: 2 minutes interval  
 up to 106 times: 10 seconds interval

**10 Series**  
 (CNR10D180K to CNR10D680K)

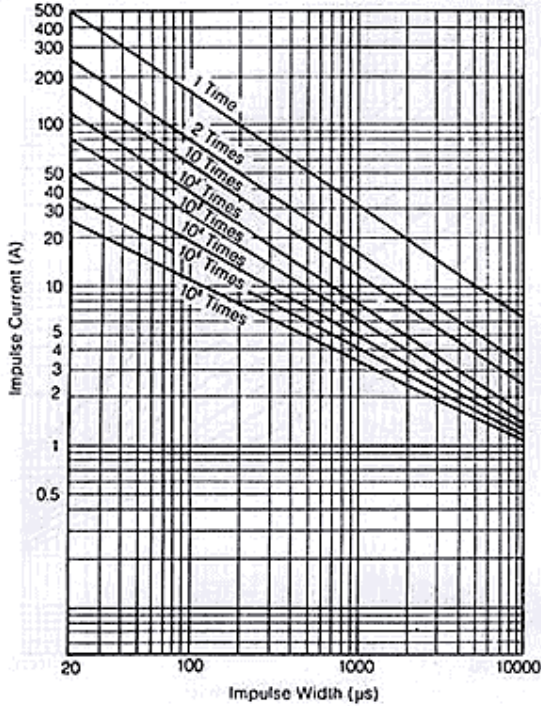

**10 Series**  
 (CNR10D820K to CNR10D471K)

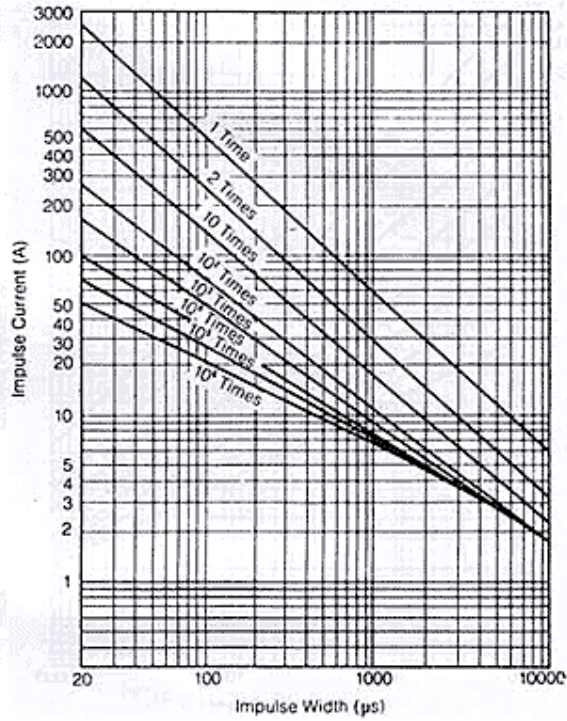

**10 Series**  
 (CNR10D511K to CNR10D112K)

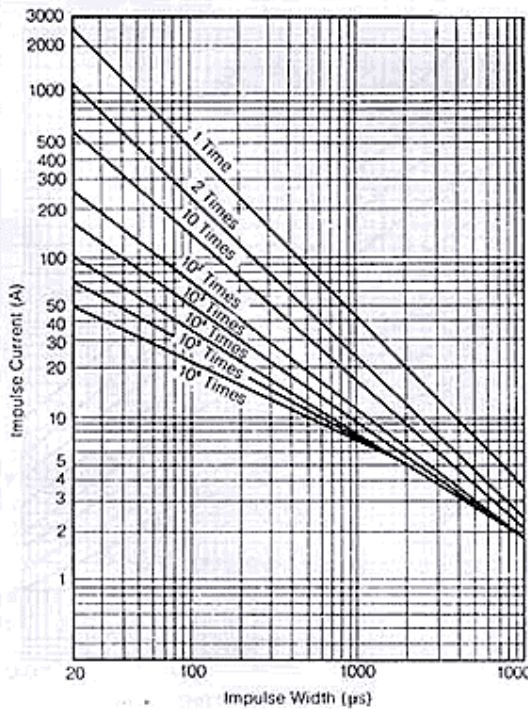

**14 Series**  
 (CNR14D180K to CNR14D680K)

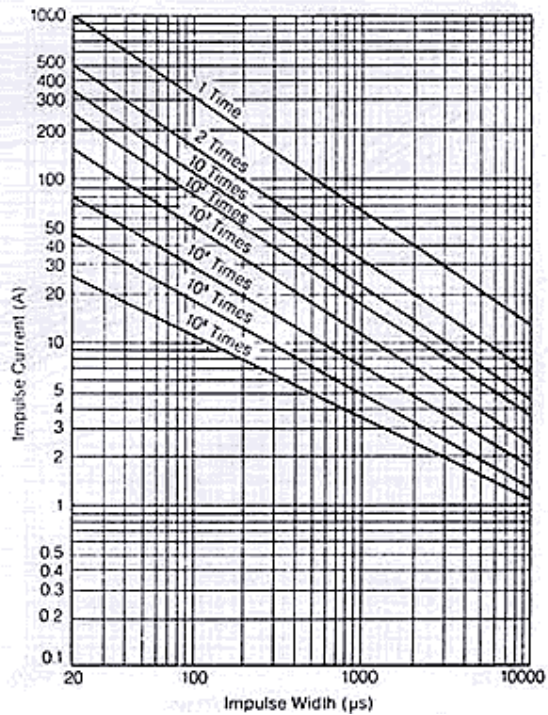

et4U.com

DataShee



**Impulse Life Time Rating Curves**

2 times: 5 minutes interval  
 up to 10 times: 2 minutes interval  
 up to 106 times: 10 seconds interval

**14 Series**  
 (CNR14D820K to CNR14D471K)

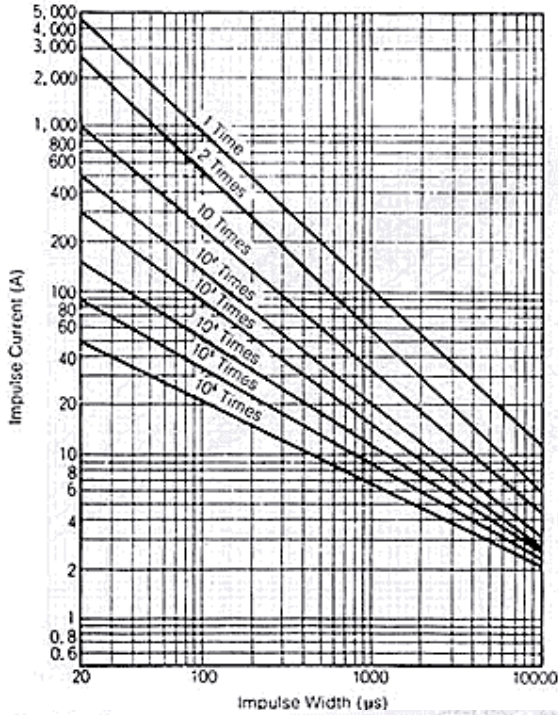

**14 Series**  
 (CNR14D511K to CNR14D182K)

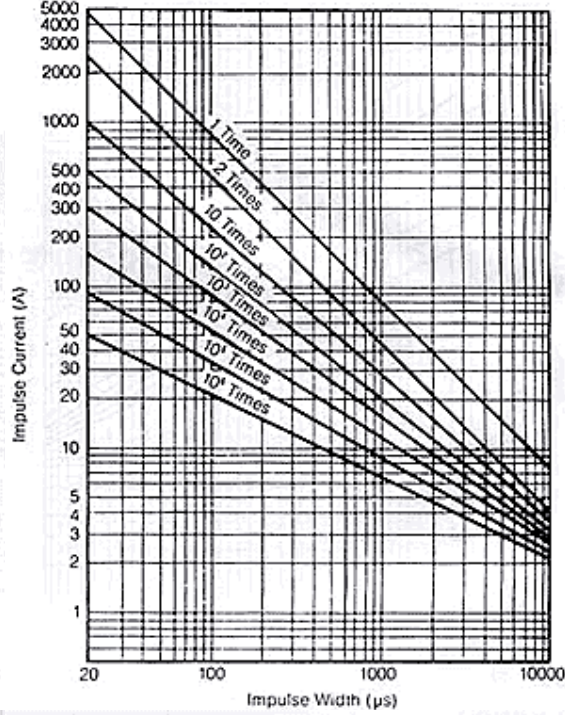

**20 Series**  
 (CNR20D180K to CNR20D680K)

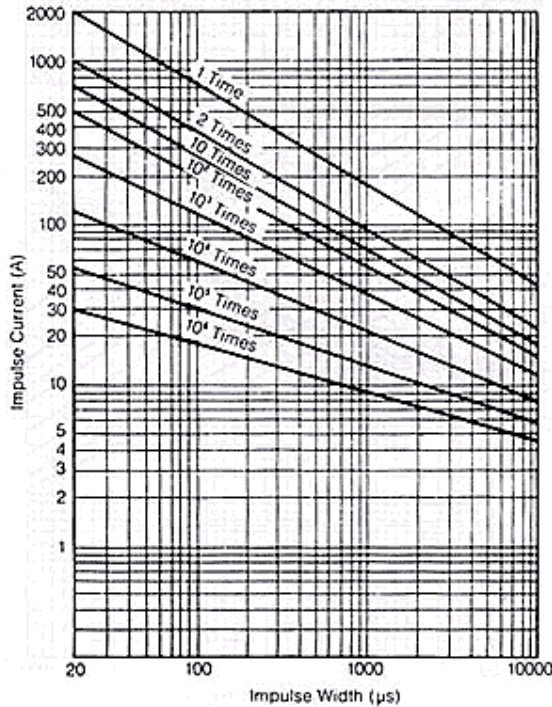

**20 Series**  
 (CNR20D820K to CNR20D471K)

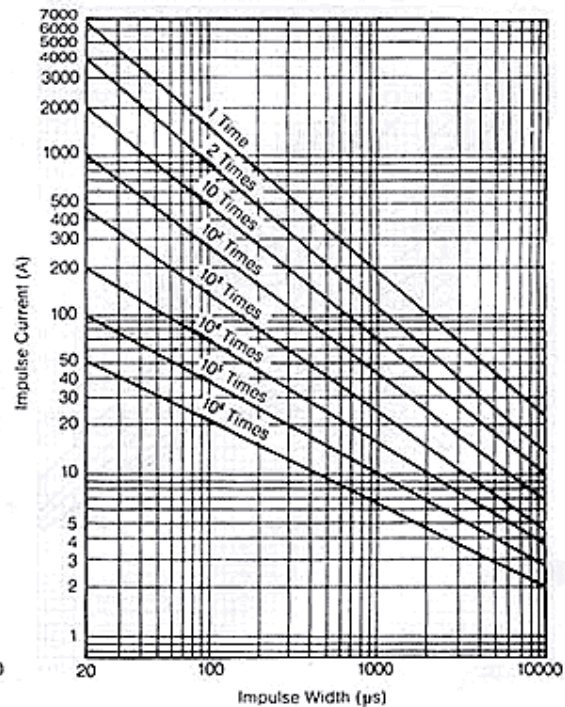



**Transient/Surge Absorbers  
Transient Voltage Surge Suppressors**

**20 Series**

(CNR20D511K to CNR20D182K)

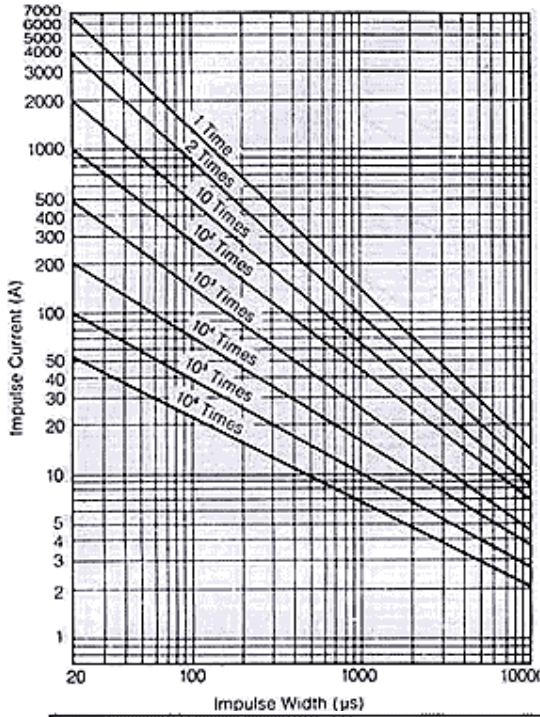

**V-I Curve (CNR20D621K to CNR20D182K)**

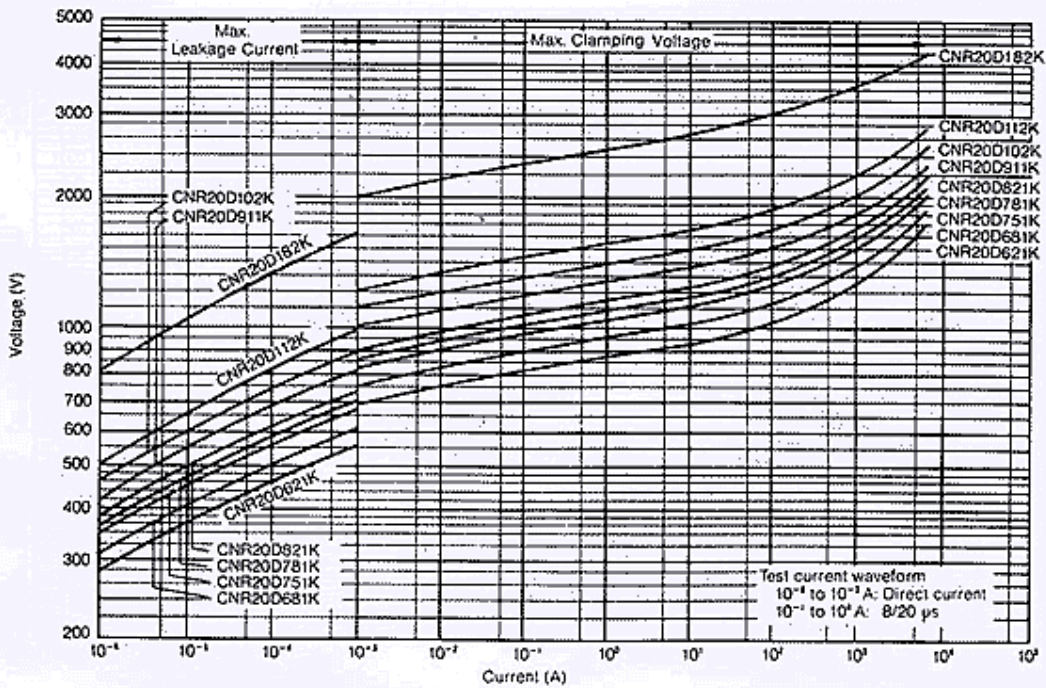



### Transient/Surge Absorbers Transient Voltage Surge Suppressors

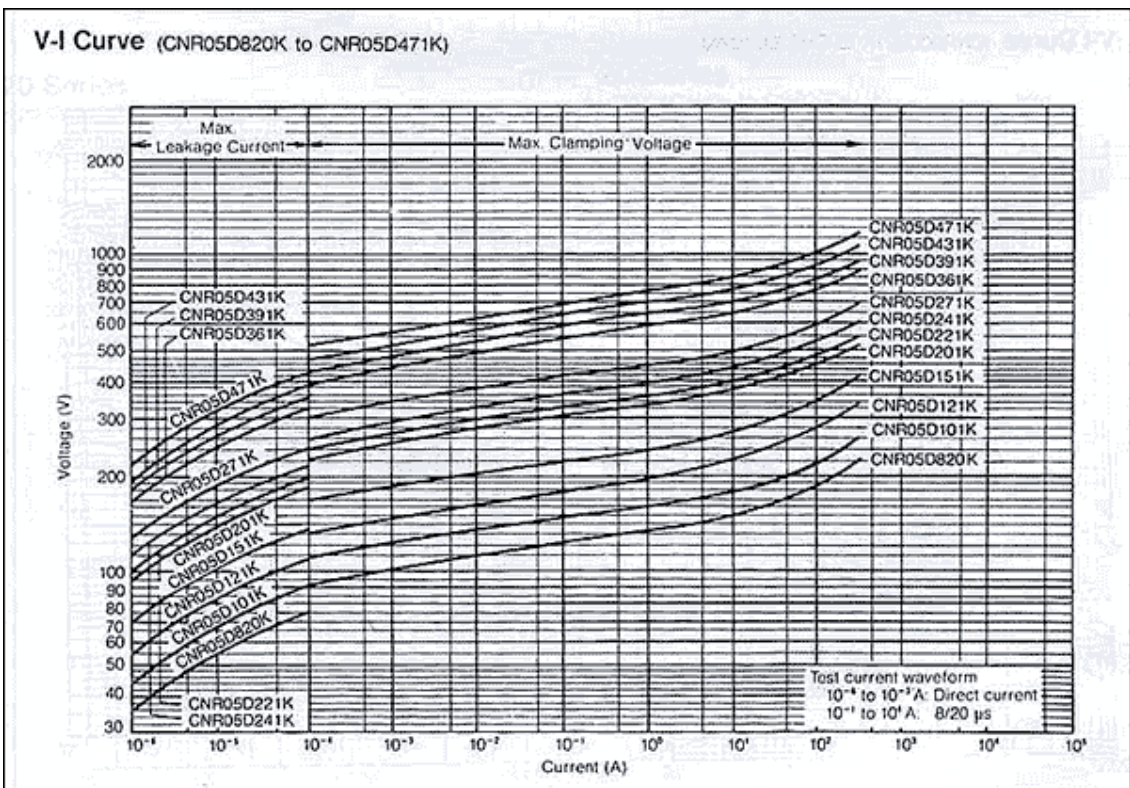
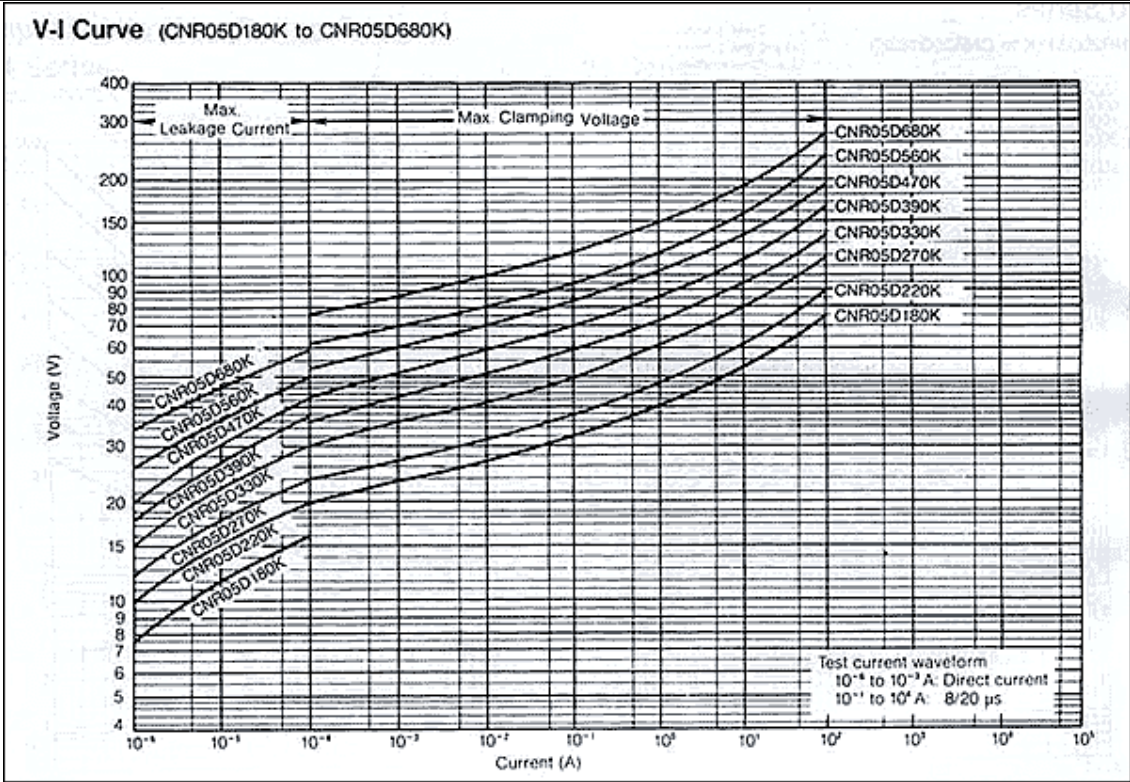





### Transient/Surge Absorbers Transient Voltage Surge Suppressors

V-I Curve (CNR07D180K to CNR07D680K)

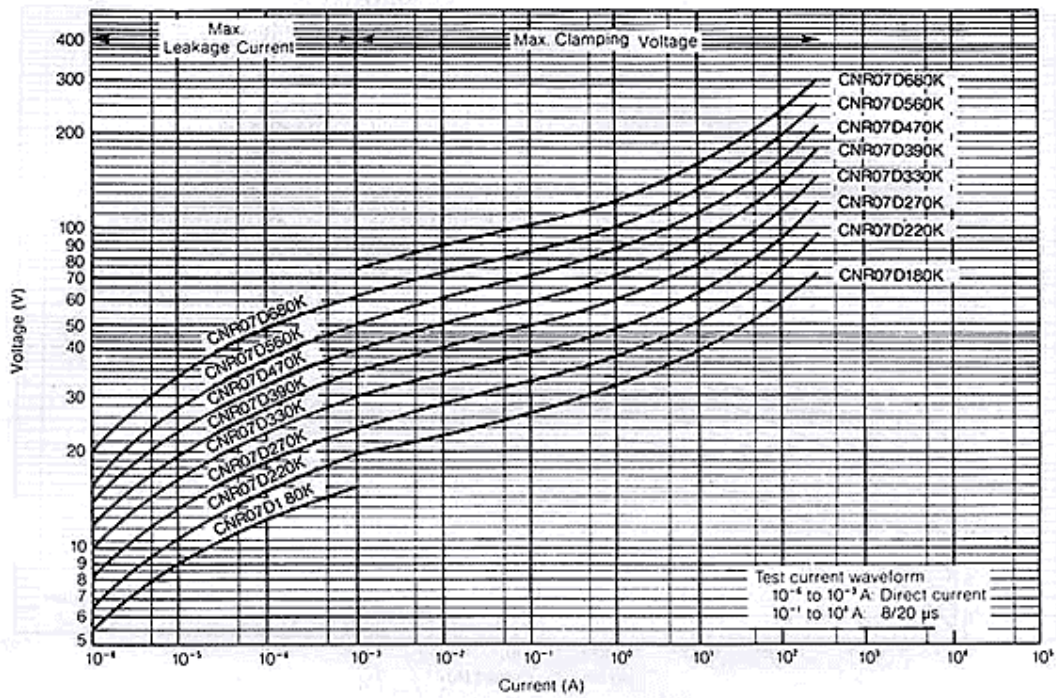

V-I Curve (CNR07D820K to CNR07D471K)

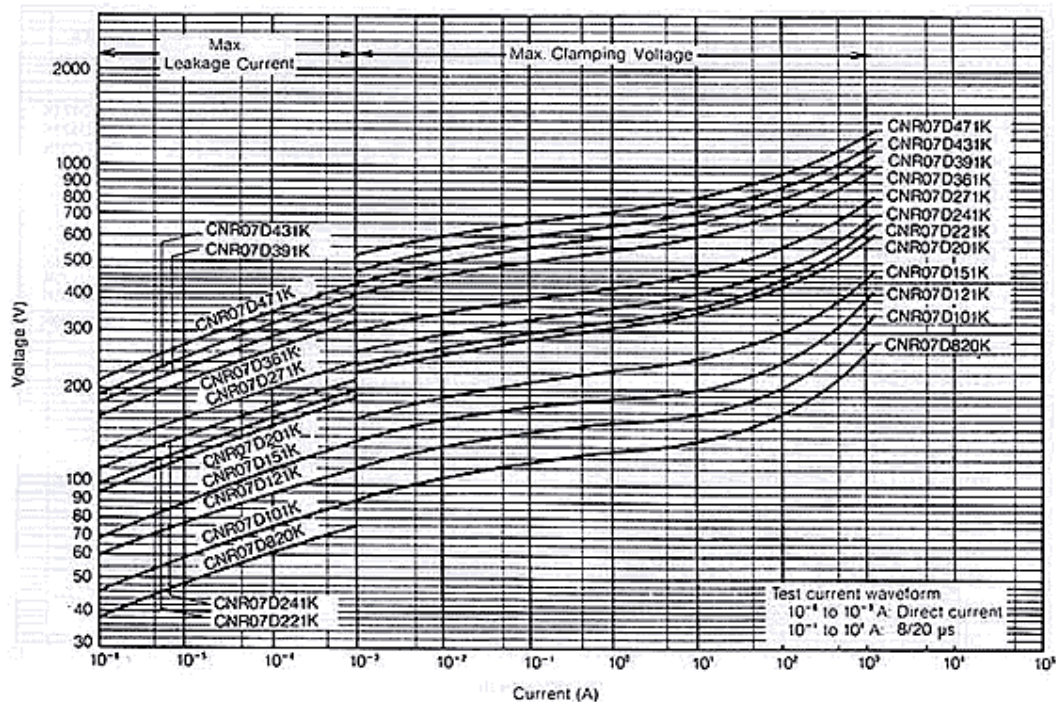

et4U.com

DataSheet



### Transient/Surge Absorbers Transient Voltage Surge Suppressors

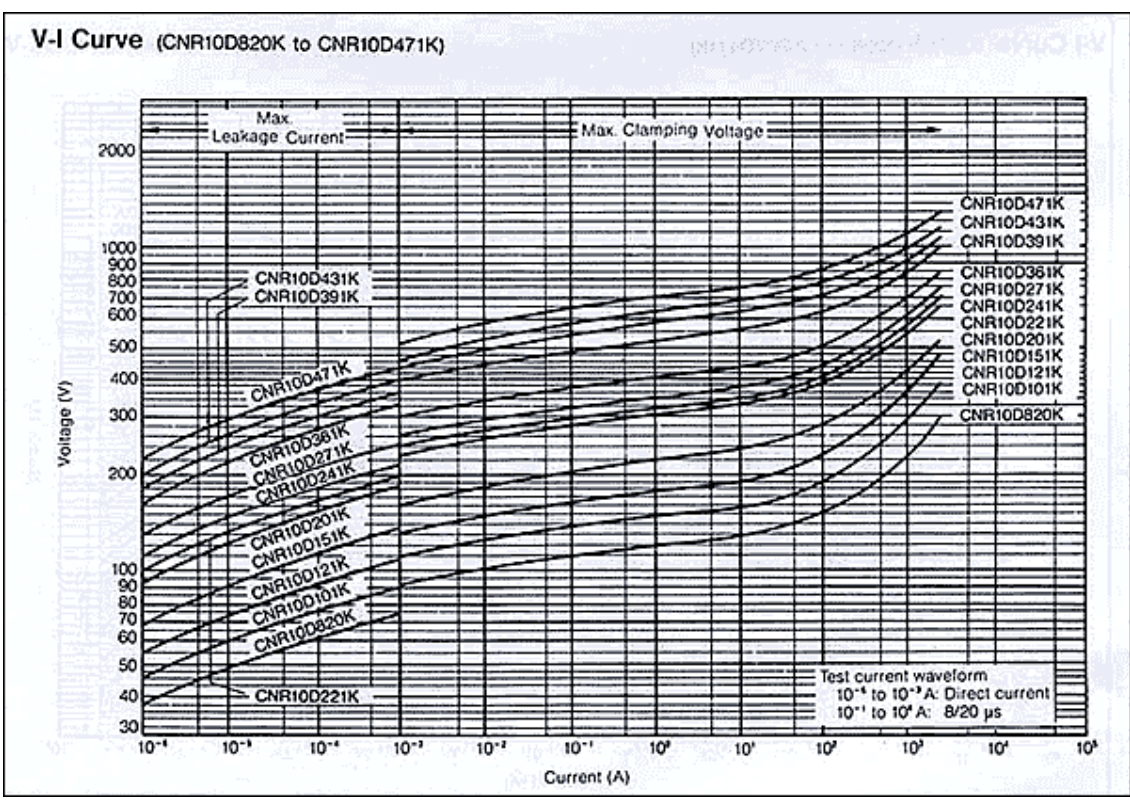
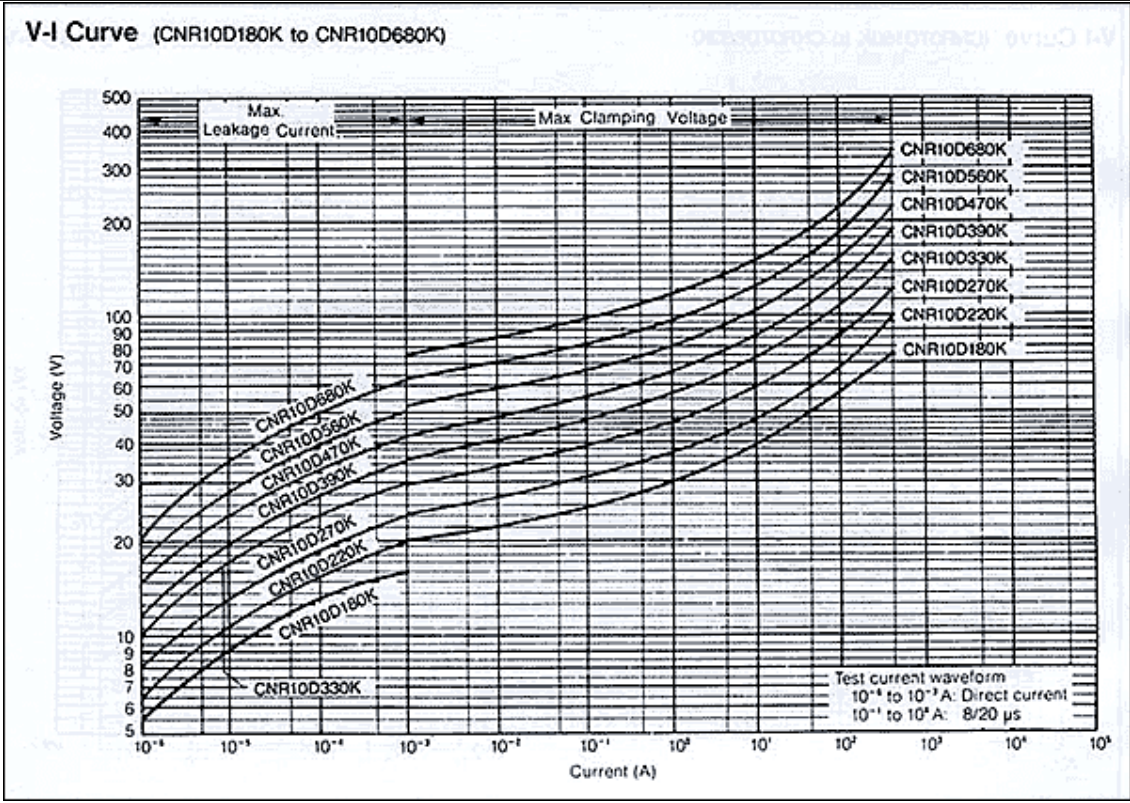



**Transient/Surge Absorbers  
Transient Voltage Surge Suppressors**

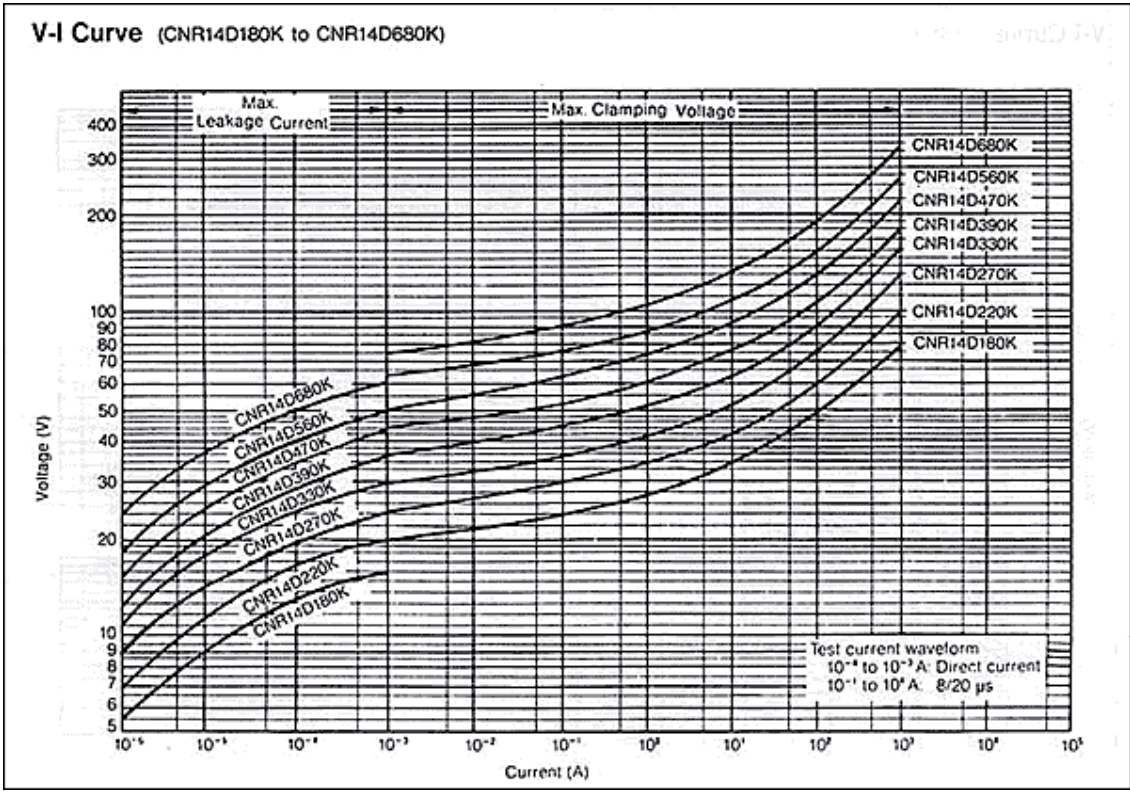
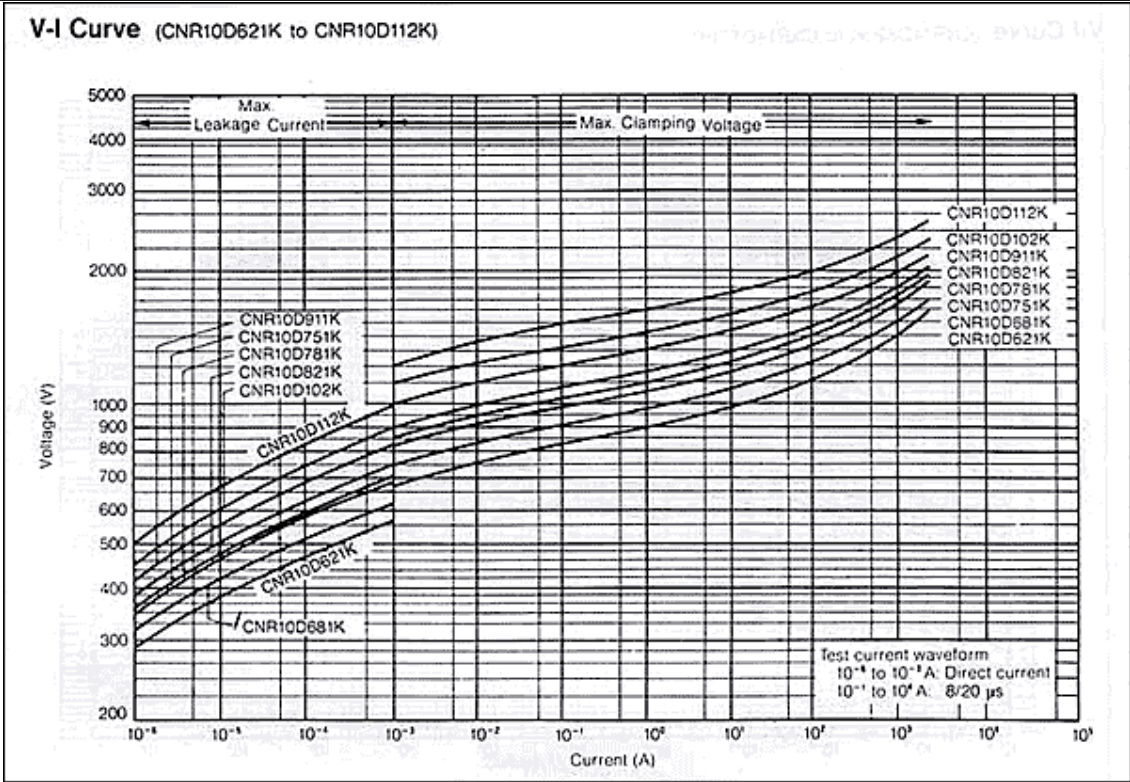

et4U.com

DataSheet



### Transient/Surge Absorbers Transient Voltage Surge Suppressors

V-I Curve (CNR14D820K to CNR14D471K)

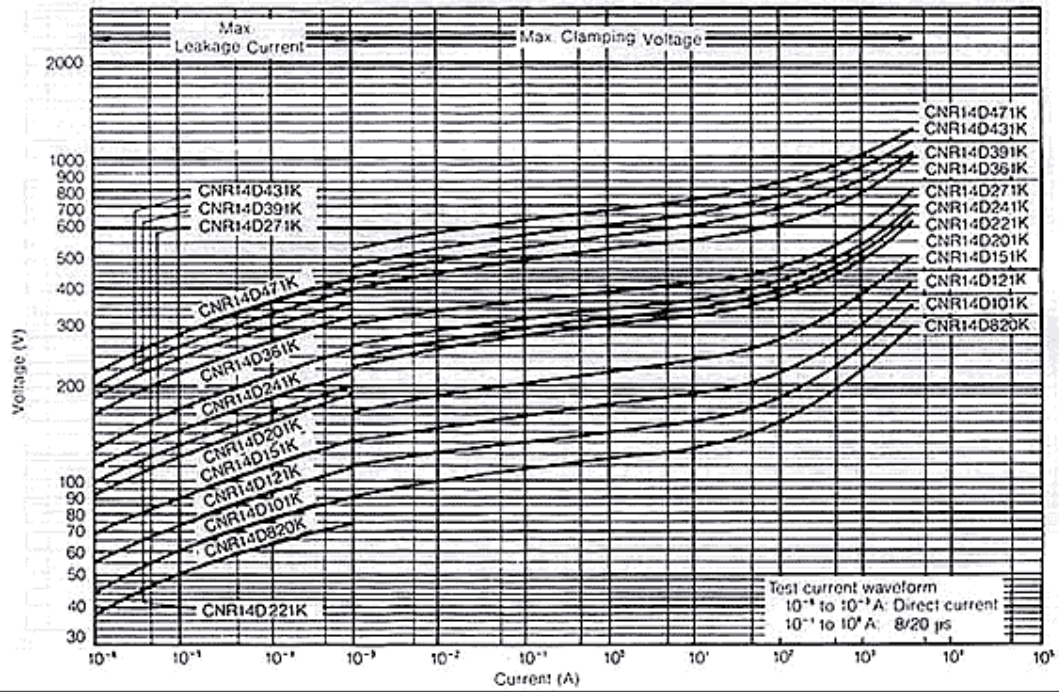

V-I Curve (CNR14D621K to CNR14D182K)

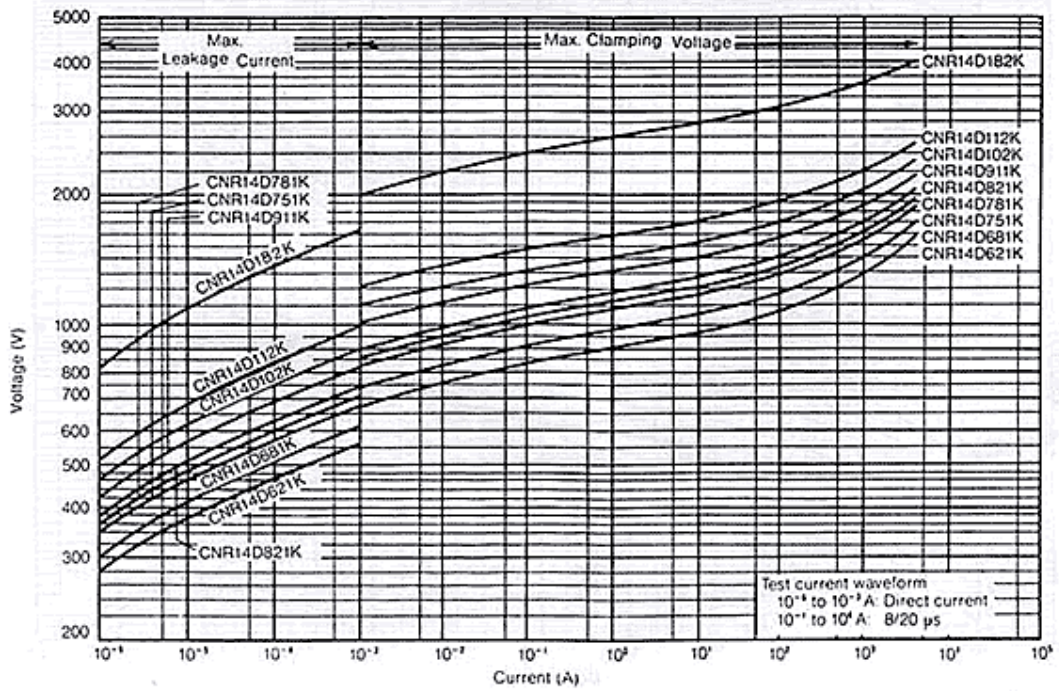



### Transient/Surge Absorbers Transient Voltage Surge Suppressors

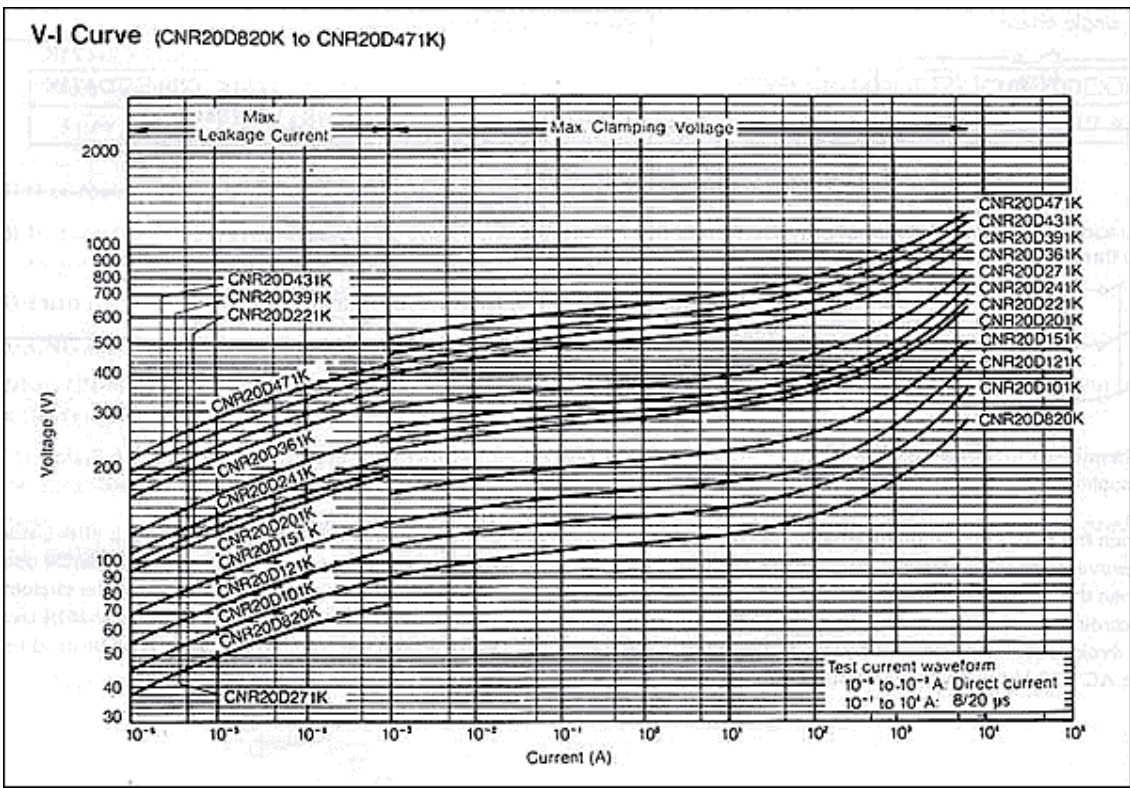
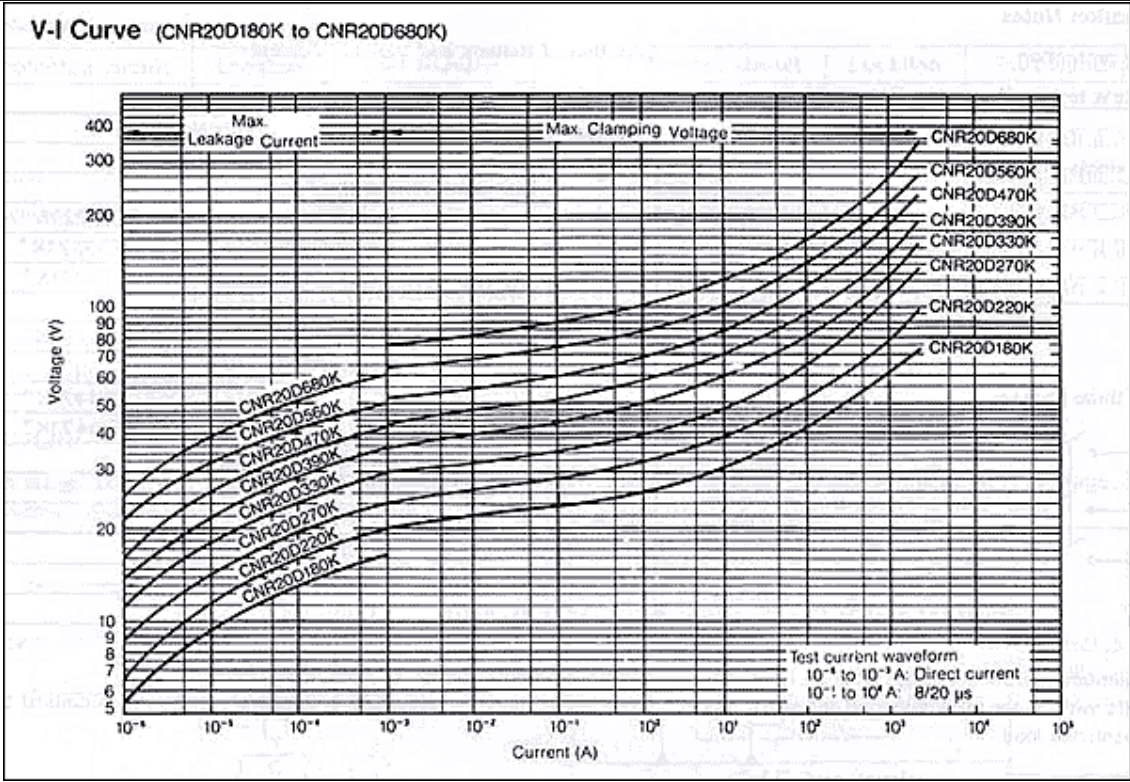



## Transient/Surge Absorbers Transient Voltage Surge Suppressors

### Application Notes

#### 1. Line protection

##### Line to line Protection Connections

DC

AC single phase

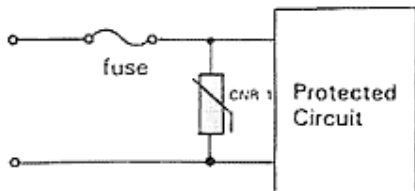

AC three phases

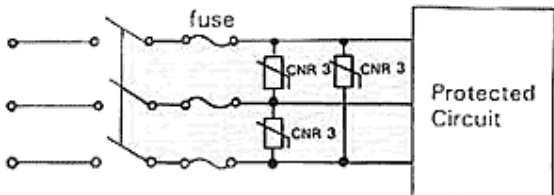

#### Selection of Ratings and Varistor Voltage

##### Line to Line

Symbol	Line Voltage	Part Number	
CNR 1	DC 12V	CNR- D220K	
	DC 24V	CNR- D390K	
	AC 100V		CNR- D201K, CNR- D221K
			CNR- D241K*, CNR- D271K*
	AC 120V	CNR- D241K, CNR- D271K*	
	AC 127V	CNR- D271K	
	AC 200V		CNR- D391K, CNR- D431K
CNR- D471K			
CNR 3	AC 240V	CNR- D431K, CNR- D471K*	
	AC 240V		CNR- D511K
			CNR- D511K
	AC 265V	CNR- D511K	
	AC 380V	CNR- D821K	
	AC 415V	CNR- D911K	
	AC 460V		CNR- D112K
CNR- D112K			

Notes:

1. Maximum operating voltage shall be lower than Maximum allowable voltage of CNR at any time.
2. CNRs with \* are recommended for single phase, 3 wire applications to withstand a temporary overvoltage caused by unbalance load.

##### Line to Line and Line to Ground Protection Connections

#### Selection of Ratings and Varistor Voltage

##### Line to Ground

DC

AC single phase

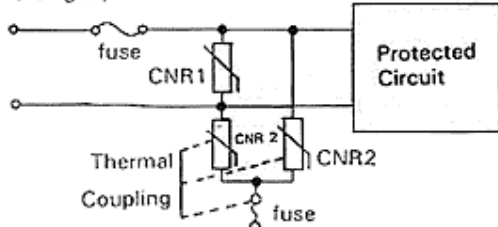

AC three phases

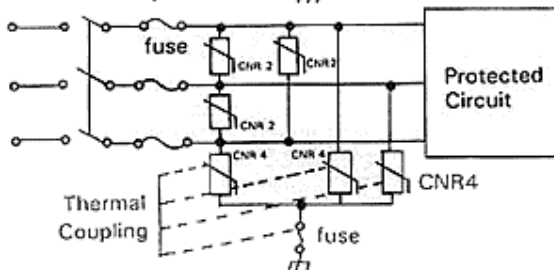

Notes:

1. When the 500V insulation resistance test of the circuits employing CNRs is conducted, CNR shall be remove after getting approval from the customer, or CNR \*\* with the Maximum Allowable Voltage exceeding to test voltage shall be used.
2. When the 1000V withstanding voltage test is conducted, CNR shall be remove after getting approval from the customer according to the relevant regulations, or CNR \*\* with the Maximum Allowable Voltage exceeding to the test voltage shall be used.
3. To avoid CNR failure caused by the ground fault, CNR with higher Varistor Voltage listed in the table shall be used for the AC 120V line to ground application.

Symbol	Line Voltage	Part Number
	AC 100V to AC 220V	CNR- D431K, CNR- D471K CNR- D431K, CNR- D471K or CNR- D751K**
	AC 240V or higher Varistor Voltage	CNR- D182K***
CNR 4	AC 240V	CNR- D431K CNR- D471K or CNR- D751K** or higher Varistor Voltage CNR- D182K***



## Transient/Surge Absorbers Transient Voltage Surge Suppressors

### Application examples

Protected circuit	Location	Part Number
Home Appliances	Indoor	CNR-05D K
		CNR-07D K
		CNR-10D K
	Outdoor	CNR-10D K
		CNR-14D K
		CNR-20D K
Consumer Industrial	Indoor, Outdoor	CNR-14D K
		CNR-20D K

Protected circuit	Location	Part Number
Communication Measurements Controls	Indoor	CNR-07D K
		CNR-10D K
		CNR-14D K
	Outdoor	CNR-05D K
		CNR-07D K
		CNR-10D K

#### CAUTION:

1. A surge excess of the specific Maximum Peak Current may cause short circuit or mechanical damage. The following measures are recommended.

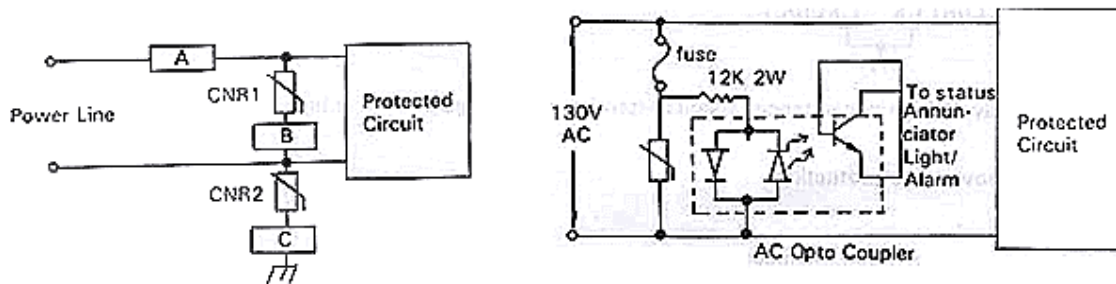

- 1) Location of the over current protector (circuit breaker or current fuse) shall be in the power line to the circuit (Location A) or in series with CNR (Location B).

Part Number	CNR-05D K	CNR-07D K	CNR-10D K	CNR-14D K	CNR-20D K
Fuse Rating	1 to 2 A	2 to 3 A	3 to 5 A	3 to 10 A	5 to 15 A

- 2) It is recommended that a fuse listed in the table shall be put in location A or B.
  - 3) In case that CNR is used in line to ground, the ground fault circuit interrupter shall be applied in locate A or thermally coupled fuse shall be applied in location C.
  - 4) Fuse mounted Type K or Type P are available for CNR 1 and CNR 2 applications.
  - 5) CNR shall not be used near the flammable materials.
2. When CNR is molded at end-user, molding resin materials shall be carefully selected, otherwise CNR's long term stability could degrade.
  3. CNR shall not be used near heat generating device and free from direct sunlight. CNR shall be used with in the specified Operating Temperature Range.
  4. CNR shall be free from dust, metal powder, dew and sea wind. A protective box is recommended to prevent the unit from those.



## 2. Signal Line and telephone line surge protection

### Signal line

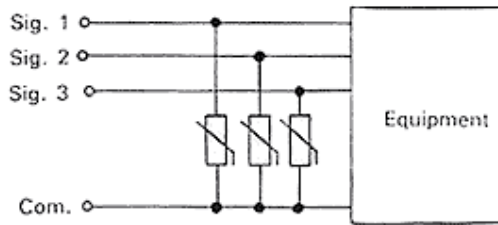

### Selection Example

#### Surge Protection of Signal Line

Signal Line Voltage	Part Number
DC 48 V	CNR- D820K
DC 100 V	CNR- D201K

### Telephone Line

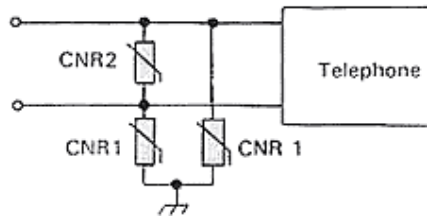

### Surge Protection of Telephone Line

CNR	Part Number
CNR 1	CNR- D331K CNR- D361K
CNR 2	CNR- D151K

#### Note:

CNR has relatively high capacitance, special attention shall be paid for it in high frequency circuits.

#### Caution:

Refer to the power line protection.

## 3. Switching surge protection, semiconductor protection and contact spark suppression

### Switching surge protection

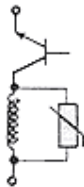

### Semiconductor protection

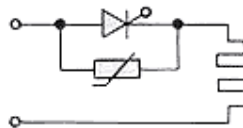

### Contact spark suppression

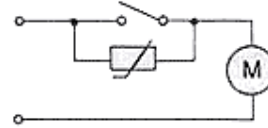

#### Selection examples

Voltage	Part Number
DC 12V	CNR- D220K
DC 24V	CNR- D390K
DC 100V	CNR- D151K
DC 120V	CNR- D221K
	CNR- D241K
	CNR- D271K

#### Note:

1. The Maximum Allowable Voltage to be higher than maximum operation voltage at all time.
2. Energy handling capability of CNR shall be selected by studying switching surge energy from the inductive load.

#### Caution:

1. Refer to the mentioned caution described in power line protection.
2. The relation between surge current repetition and CNR ratings is drawn in the CNR's impulse life characteristics.
3. Capacitor connection in parallel CNR is recommended for a contact spark suppression.