

W30 Series DC/DC MODULES

Applications

- Servers, Switches and Data Storage
- Wireless Communications
- Distributed Power Architecture
- Semiconductor Test Equipment
- Networking Gear
- Data Communications
- Telecommunications
- Industrial / Medical

The W30 Family of high efficiency DC/DC converters offer power levels of up to 30 Watts, exceeding that of other products with the same Industry-Standard Pinouts, while providing much smaller footprints. With a wide input voltage range and single outputs, ranging from 1.5 to 15 Volts, these converters provide versatility without sacrificing the board space. All models feature an input filter and microcontroller-based protection features. The open frame construction allows very efficient heat transfer with no hot spots. All converters combine creative design practices with highly derated power devices to achieve superior efficiencies (up to 94%), reliability, high performance and low cost solution to systems designers.

Specifications & Features Summary

- No minimum load required
- On/Off pin control
- -40°C to +85°C ambient operation
- Output adjustment +/-10% range
- 1500V, 10MΩ input-to-output isolation
- Output overcurrent protection
- Input Under voltage protection
- Input Over voltage protection
- Synchronous rectification topology
- MTBF of up to 1,000,000 hours @ 50°C (Bellcore)
- Over Voltage protection
- Over Temperature protection
- Please add suffix "A" or "B", depending on Pinout
- Please add suffix "N" for Negative Logic
- Delivers up to 30W in 1" x 2" package with Industry-Standard Pinouts
- UL 60950 pending, TUV EN60950 and CSA C22.2 No. (Pending)



Model	Input Voltage Range (Vin)	Iin No Load	Iin Full Load (A)	Output Voltage (Vo)	Output Current (Io) A	Eff (Typ) %	Regulation Line/Load (%)	Ripple / Noise (mV) pk-pk
W30-12S1.5	9-18	0.030	2.0	1.5	10.0	83	±0.2 / ±0.2	15
W30-12S1.8	9-18	0.035	2.38	1.8	10.0	84	±0.3 / ±0.2	15
W30-12S2.5	9-18	0.040	3.26	2.5	10.0	85	±0.2 / ±0.2	15
W30-12S3.3	9-18	0.040	3.26	3.3	8.0	90	±0.2 / ±0.2	20
W30-12S5	9-18	0.050	3.66	5.0	6.0	91	±0.2 / ±0.2	20
W30-12S12	9-18	0.050	3.58	12.0	2.5	93	±0.2 / ±0.2	50
W30-12S15	9-18	0.050	3.54	15.0	2.0	94	±0.2 / ±0.2	50
U30-12S1.5	9-36	0.030	2.05	1.5	10.0	81	±0.2 / ±0.2	15
U30-12S1.8	9-36	0.035	2.44	1.8	10.0	82	±0.3 / ±0.2	15
U30-12S2.5	9-36	0.040	3.30	2.5	10.0	84	±0.2 / ±0.2	15
U30-12S3.3	9-36	0.040	3.35	3.3	8.0	88	±0.2 / ±0.2	20
U30-12S5	9-36	0.050	3.75	5.0	6.0	89	±0.2 / ±0.2	20
U30-12S12	9-36	0.050	3.70	12.0	2.5	90	±0.2 / ±0.2	50
U30-12S15	9-36	0.050	3.66	15.0	2.0	91	±0.2 / ±0.2	50
W30-24S1.5	18-36	0.025	1.00	1.5	10.0	83	±0.2 / ±0.2	15
W30-24S1.8	18-36	0.028	1.19	1.8	10.0	84	±0.3 / ±0.2	15
W30-24S2.5	18-36	0.032	1.63	2.5	10.0	85	±0.2 / ±0.2	15
W30-24S3.3	18-36	0.035	1.63	3.3	8.0	90	±0.2 / ±0.2	20
W30-24S5	18-36	0.040	1.83	5.0	6.0	91	±0.2 / ±0.2	20
W30-24S12	18-36	0.050	1.81	12.0	2.5	92	±0.2 / ±0.2	50
W30-24S15	18-36	0.050	1.79	15.0	2.0	93	±0.2 / ±0.2	50
W30-48S1.5	36-75	0.025	.490	1.5	10.0	85	±0.2 / ±0.2	15
W30-48S1.8	36-75	0.028	.581	1.8	10.0	86	±0.3 / ±0.2	15
W30-48S2.5	36-75	0.032	.789	2.5	10.0	88	±0.2 / ±0.2	15
W30-48S3.3	36-75	0.035	.808	3.3	8.0	91	±0.2 / ±0.2	20
W30-48S5	36-75	0.040	.905	5.0	6.0	92	±0.2 / ±0.2	20
W30-48S12	36-75	0.050	.896	12.0	2.5	93	±0.2 / ±0.2	50
W30-48S15	36-75	0.050	.886	15.0	2.0	94	±0.2 / ±0.2	50

FOR POTTED UNITS AND OTHER AVAILABLE VOLTAGES AND FEATURES PLEASE CONSULT THE FACTORY

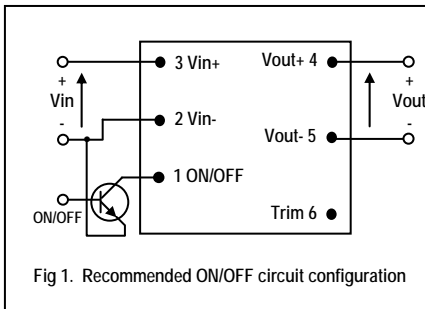

Fig 1. Recommended ON/OFF circuit configuration

Remote Sense

The unit does NOT have remote sense pins.

Output Trim (Pin 6)

Permits the user to adjust the output voltage up or down to achieve the custom voltage or to make the output voltage margining.

The unit's output voltage can be adjusted up 10% or down 10% relative to the rated output voltage by adding an external resistor between pin 6 and one of the output pins (pin 4 and 5).

To increase the output voltage, a trim resistor should be connected between pin 6(Trim) and pin 5 (Vout-).

To decrease the output voltage, a trim resistor should be connected between pin 6 (Trim) and pin 4 (Vout+).

PARAMETER	NOTES	MIN	TYP	MAX	UNIT
Absolute maximum rating					
Input voltage		0		75	V
Operating ambient temperature	(see thermal charts)	-40		85	°C
Storage temperature		-55		125	°C
Humidity				95	%
Input characteristics					
Operating input voltage range	9-18V,9-36V,18-36V, 36-75V	xx	xx	xx	V
Turn on voltage threshold		17/35			V
Turn off voltage threshold				16/34	V
Transient withstand	Transient duration: 100ms			100	V
Maximum input current	100% load , 18Vin			1.830	A
Off converter input current				10	mA
Output characteristics					
Output voltage setpoint accuracy				1.0	%Vo
Output voltage line regulation	Vin =9-18,9-36,18-36,36-75V			±0.2	%
Output voltage load regulation	0%-100%Load			±0.2	%
Output voltage trim range				±10	%
Output voltage ripple / noise	20Mz bandwidth, 100% Load, 12/24/48 Vin See pinout A notes on charts			35	mV (pk-pk)
Output over power protection		110	120	140	%
Over-voltage protection		120		135	%Vo
Temperature coefficient				±0.02	%/°C
Capacitive Load				10000	µF
Output characteristics					
Startup time	5% to 95% of the Vo			1	ms
Transient recovery time	50% load change			250	µs
Transient peak deviation	50% load change			4	%Vo
Isolation characteristics					
Isolation (primary to secondary)	1 minute		1500		VDC
Isolation resistance	1500VDC, Primary to secondary	10			MΩ
Isolation capacitance	Primary to secondary			1000	pF
Feature Characteristics					
Switching frequency	(≤2.5V = 300) (>3.3V=400)	300		400	KHz
ON/OFF control (Positive logic)	All Models				
Converter On		3.5			V
Converter Off				0.8	V
ON/OFF control (Negative logic)	All Models				
Converter On				0.8	V
Converter Off		3.5			V
Over Temperature Protection	Maximum component level			130	°C
Calculated MTBF	Bellcore @ 50°C > 1,000,000 hrs				Hrs

Basic Operations and Functions

W30 Family is a high efficiency, isolated DC/DC converter. Neither heat sink nor airflow is required when the unit operates at ambient temperature of 25°C. The unit has basic control, output adjustment and protection functions.

Input (Pin 2, Pin 3)

Input power Vin(+) must be connected to Positive input pin 3; Input power Vin(-) must be connected to Negative input pin2.

Output (Pin 4, Pin 5)

Output power Vout(+) must be connected to Positive output pin 4; Output power Vout(-) must be connected to Negative output pin6.

ON/OFF (Pin 1)

Permits the user to maintain unit On/Off, in order to properly sequence different power supplies and reduce power consumption during the standby condition. There are two ON/OFF control options: positive logic (W30-SX) and negative logic (W30-SXN). Both are referenced to Vin-.

Pin 1 is the "Enable" pin, connecting a TTL compatible pin. A TTL control signal to this pin, according to the specification, turns the unit on or off.

The positive logic unit turns on when the pin is at logic high or open, and turns off at logic low. The negative logic unit turns on when the pin is at logic low, and turns off at logic high state. Typical ON/OFF connection is shown in Fig 1.

W30-12 EFFICIENCY CHARTS

www.DataSheet4U.com

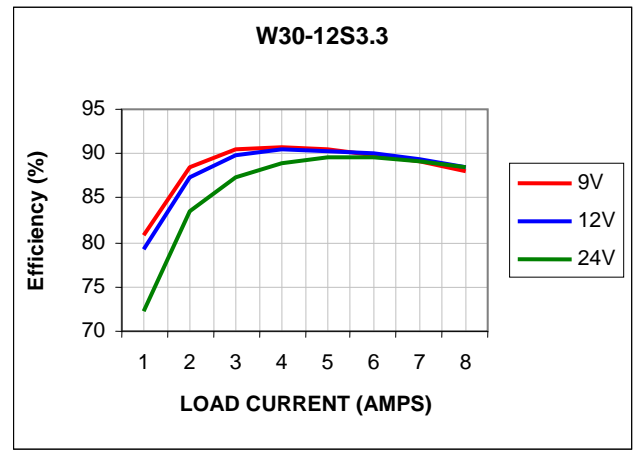
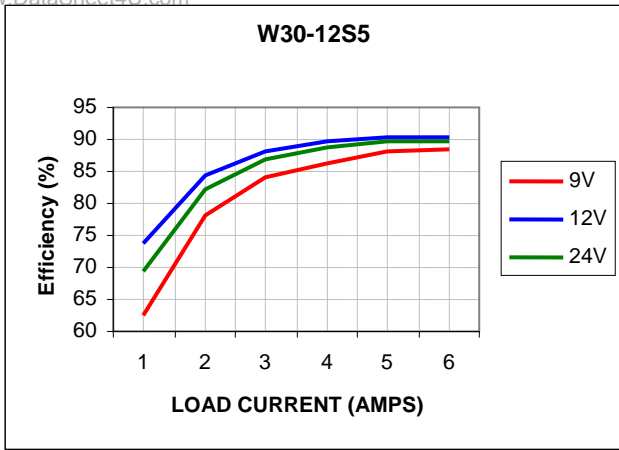

W30-12 DERATING CHARTS (STILL AIR)

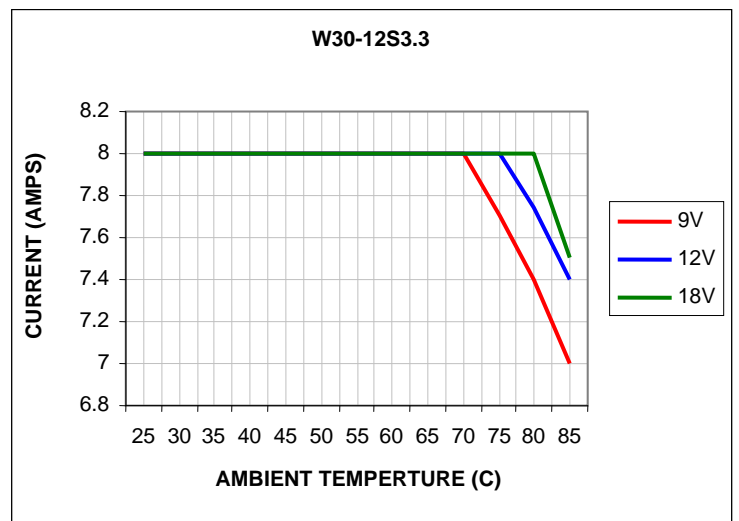
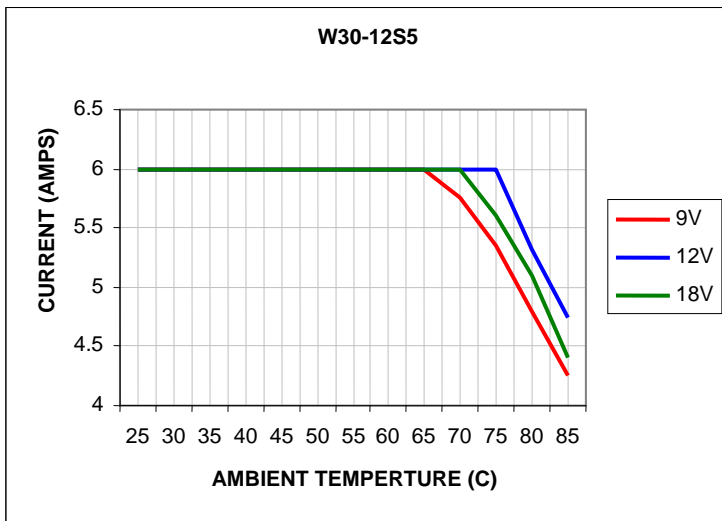

W30-12 OUTPUT NOISE

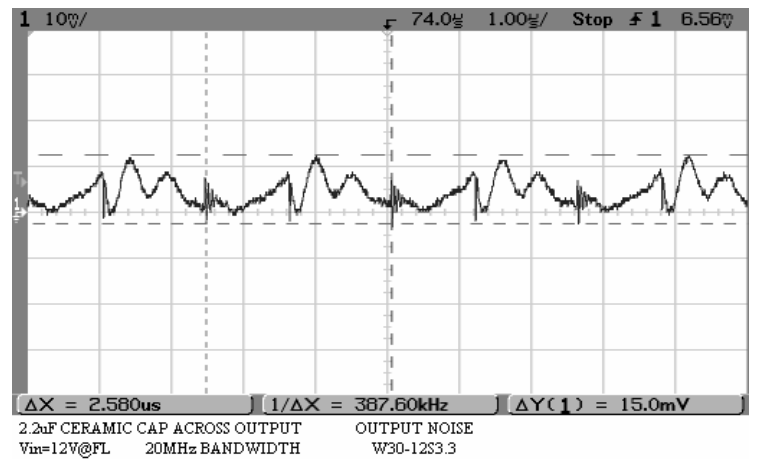
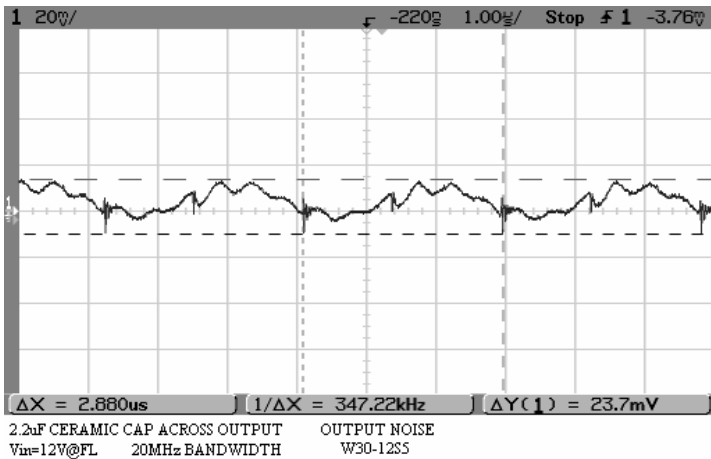

W30-12 TRANSIENT RESPONSE

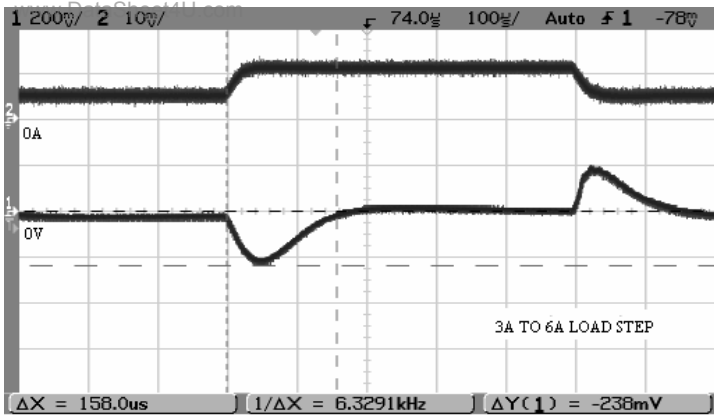

Ch 1 = 200mV/Div
Ch 2 = 5A/Div
TRANSIENT RESPONSE
W30-12S5

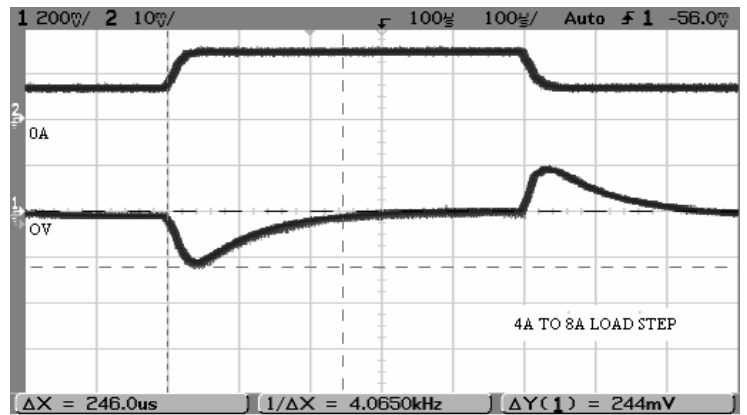

Ch 1 = 200mV/Div
Ch 2 = 5A/Div
TRANSIENT RESPONSE
W30-12S3.3

W30-12 TURN ON TIME

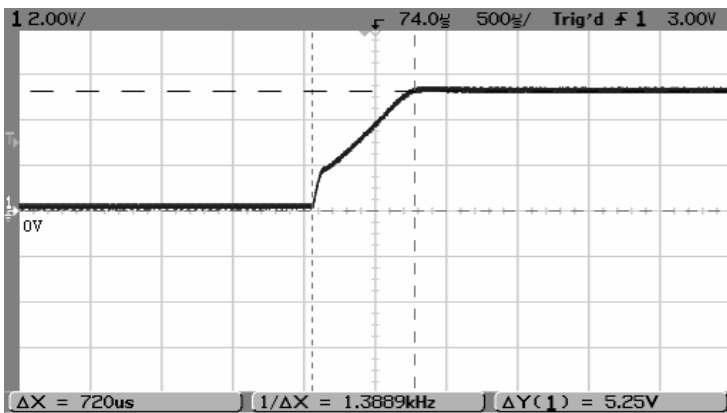

$V_{in} = 12\text{V @ FL}$
TURN ON TIME
W30-12S5

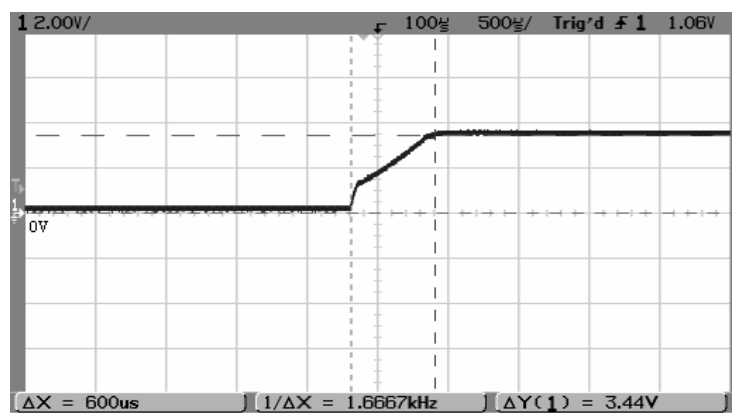

$V_{in} = 12\text{V @ FL}$
TURN ON TIME
W30-12S3.3

U30-12 EFFICIENCY CHARTS

www.DataSheet4U.com

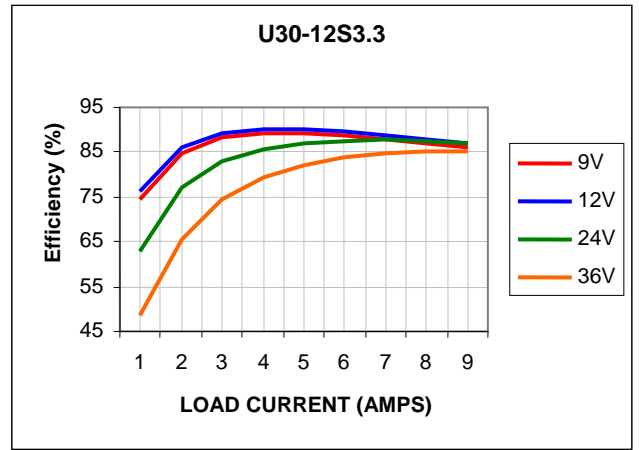
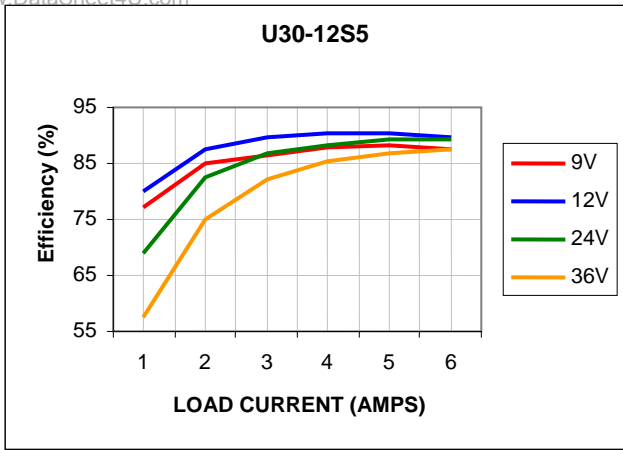

U30-12 DERATING CHARTS (STILL AIR)

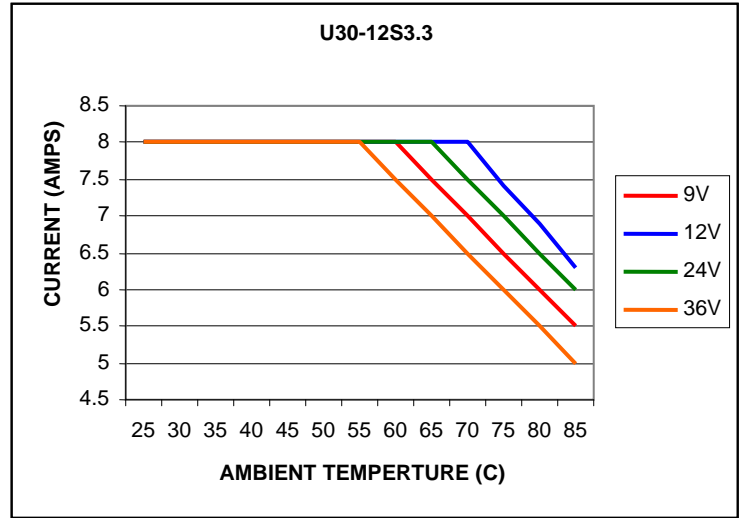
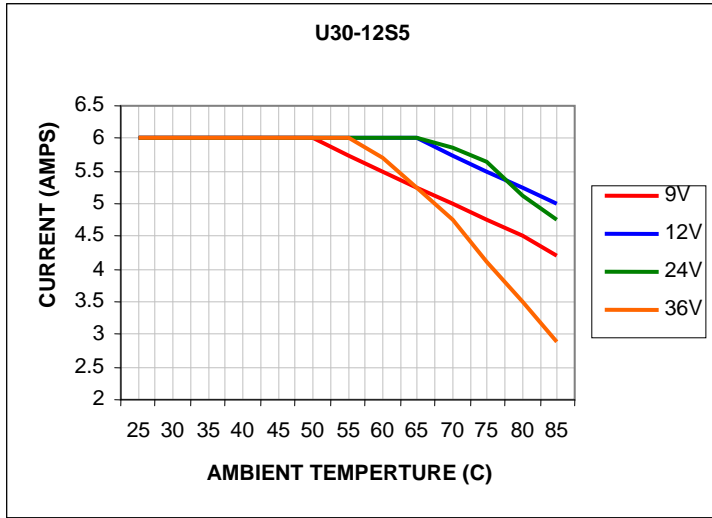

U30-12 OUTPUT NOISE

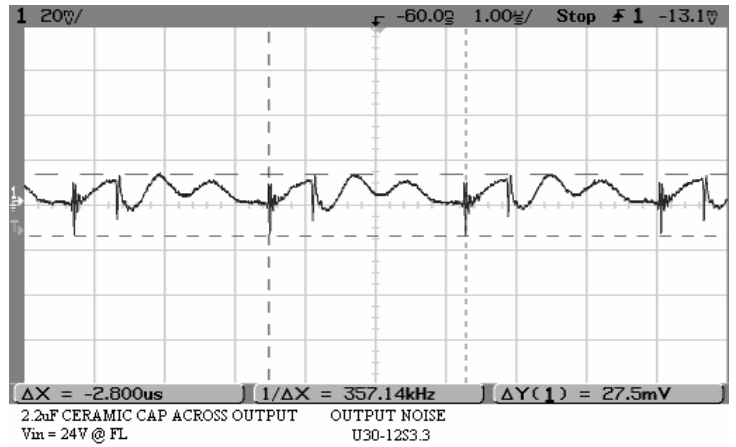
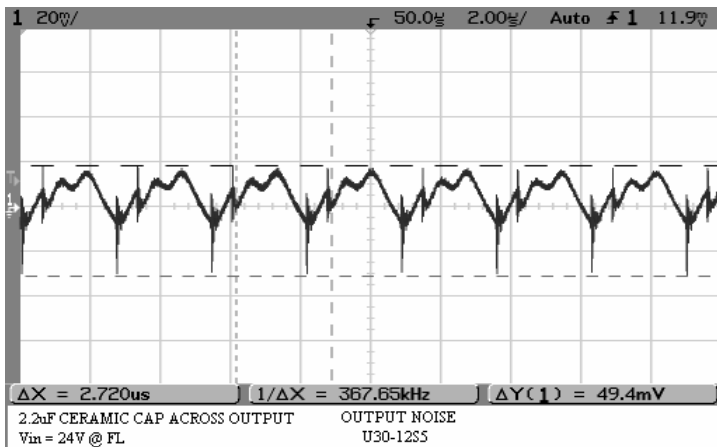

U30-12 TRANSIENT RESPONSE

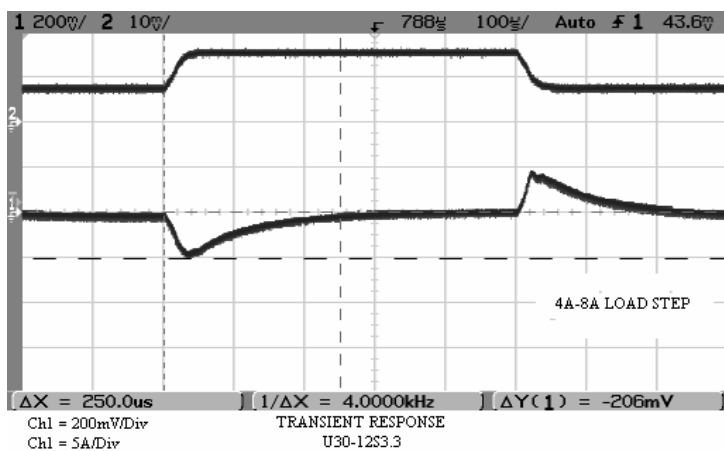
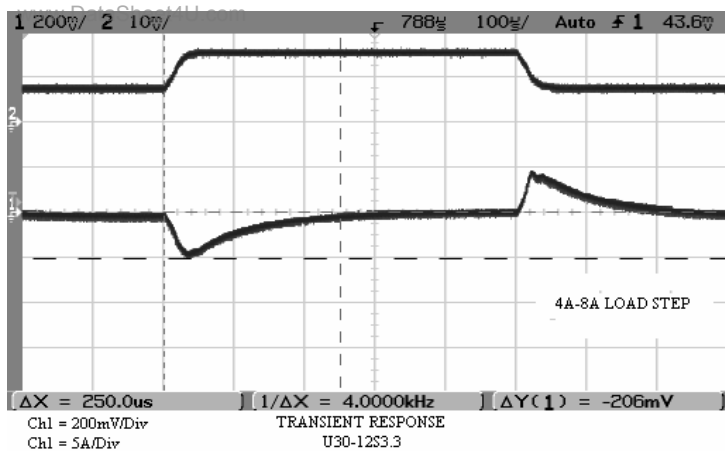

U30-12 TURN ON TIME

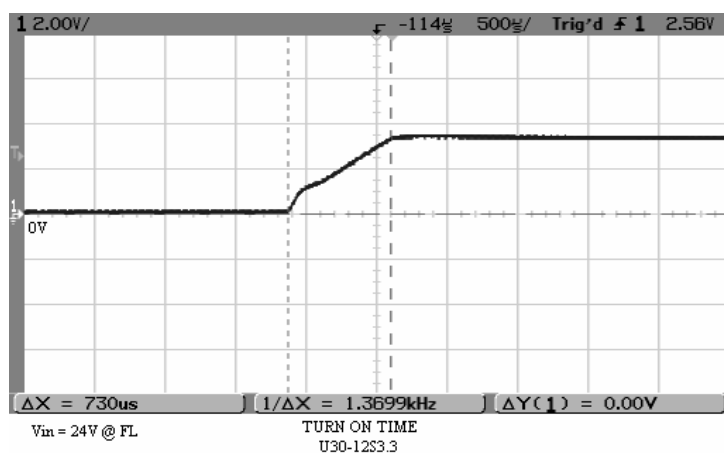
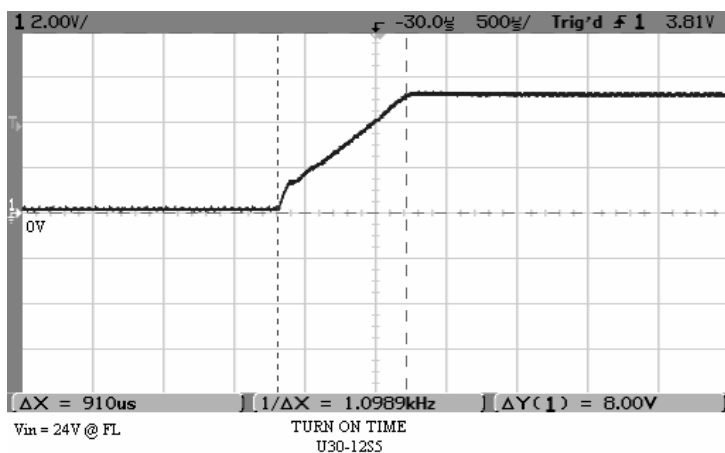

W30-24 EFFICIENCY CHARTS

www.DataSheet4U.com

W30-24S5

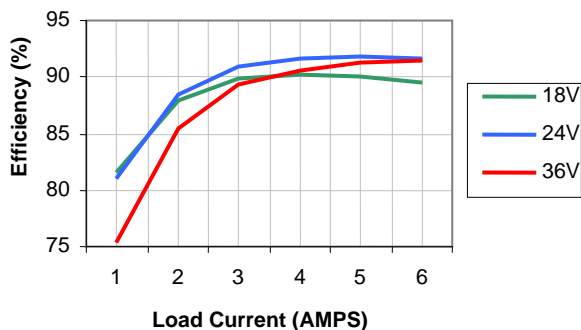

W30-24S3.3

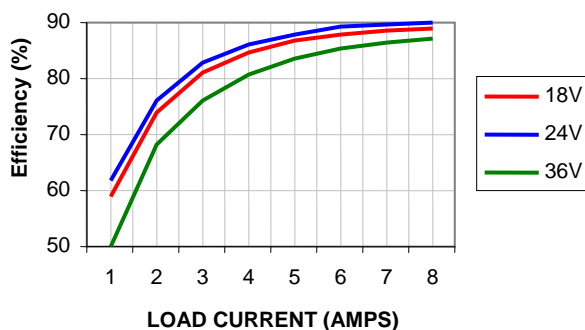

W30-24 DERATING CHARTS (STILL AIR)

W30-24S5

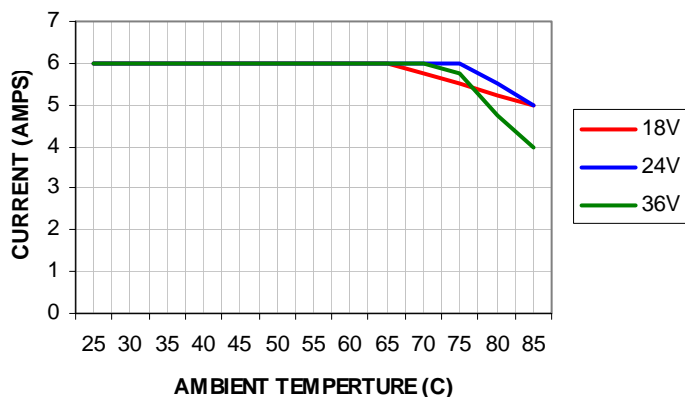

W30-24S3.3

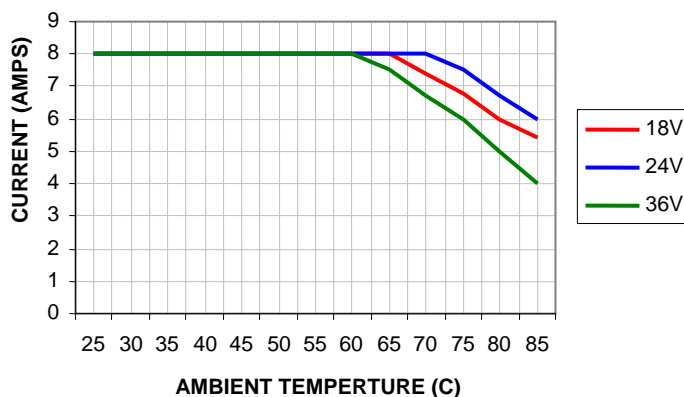

W30-24 OUTPUT NOISE

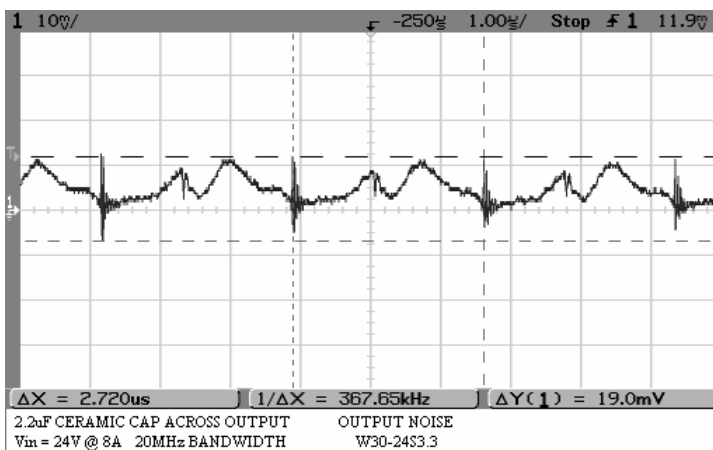
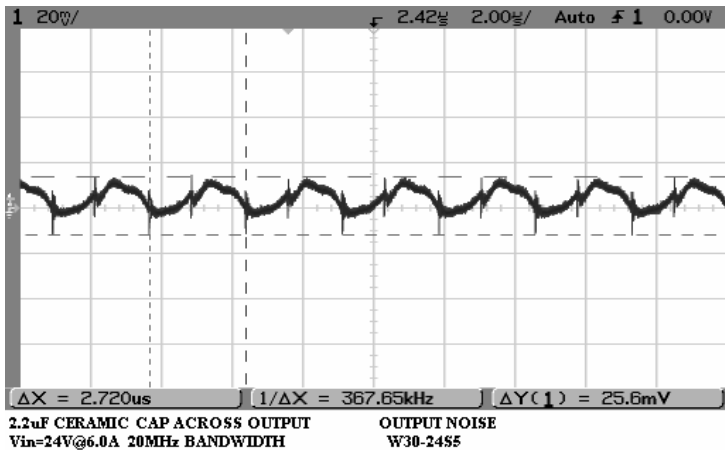

W30-24 TRANSIENT RESPONSE

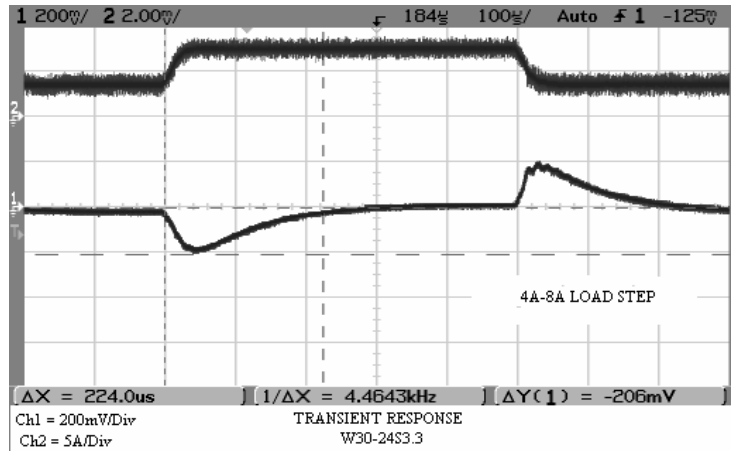
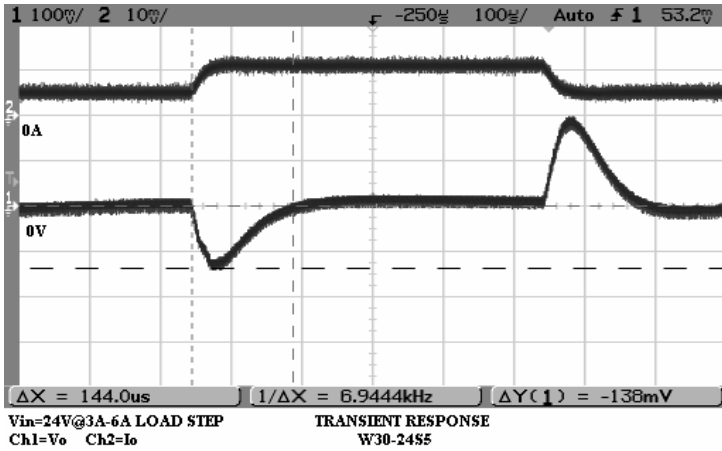

W30-24 TURN ON TIME

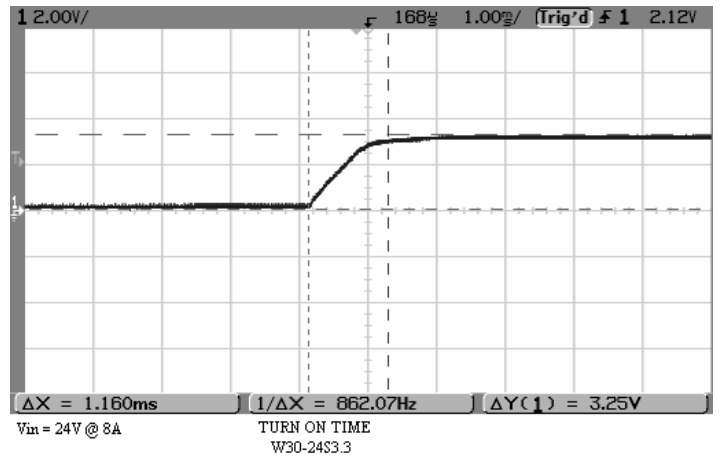
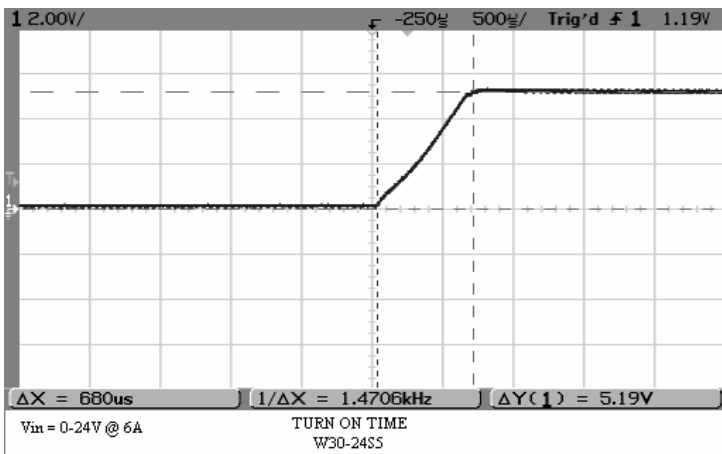

W30-48 EFFICIENCY CHARTS

www.DataSheet4U.com

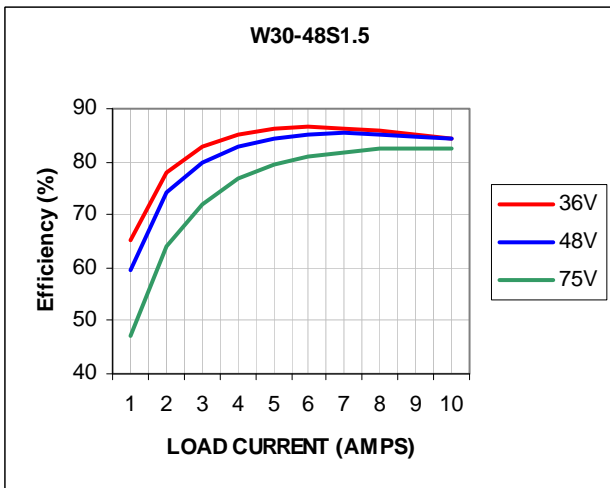
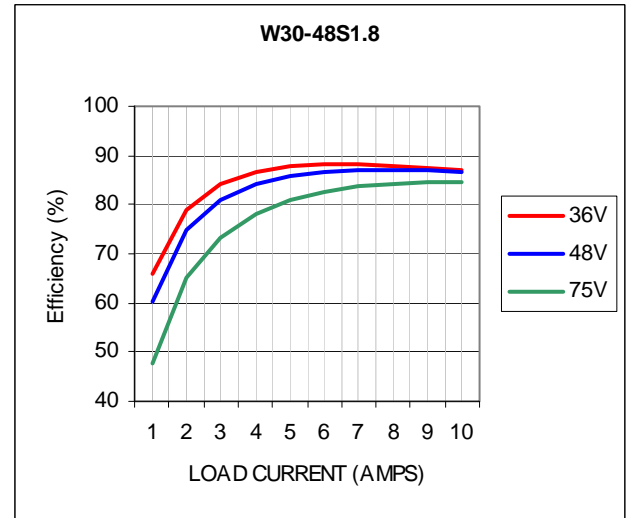
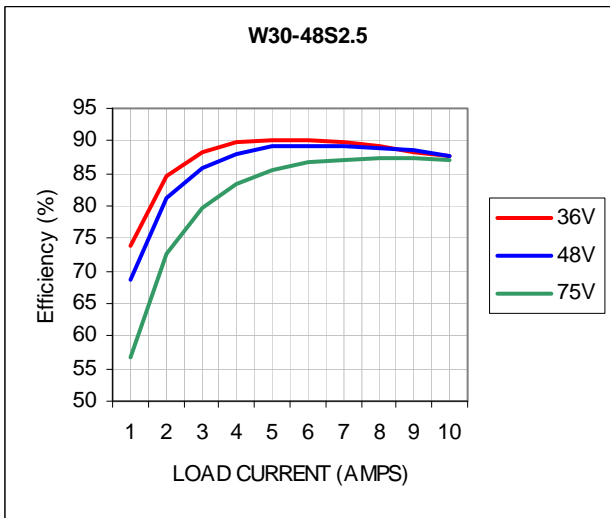
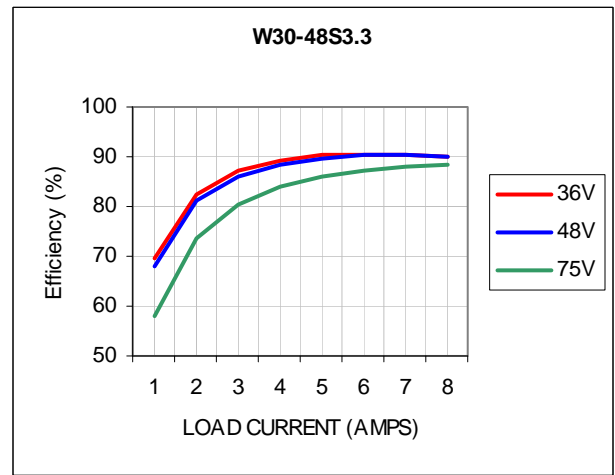
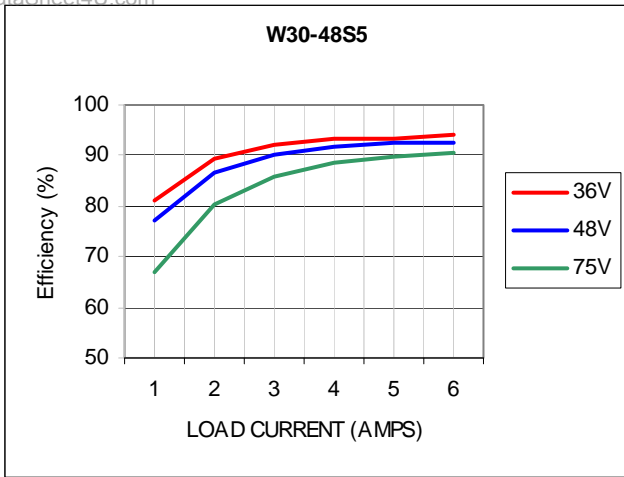

W30-48 DERATING CHARTS (STILL AIR)

www.DataSheet4U.com

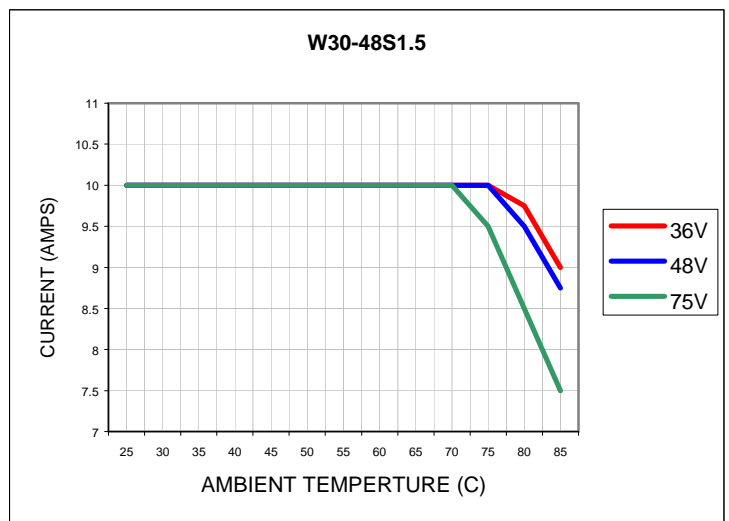
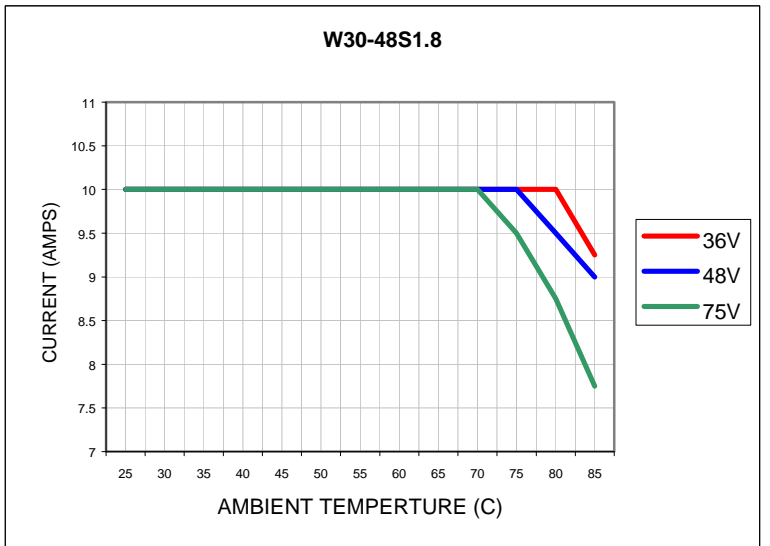
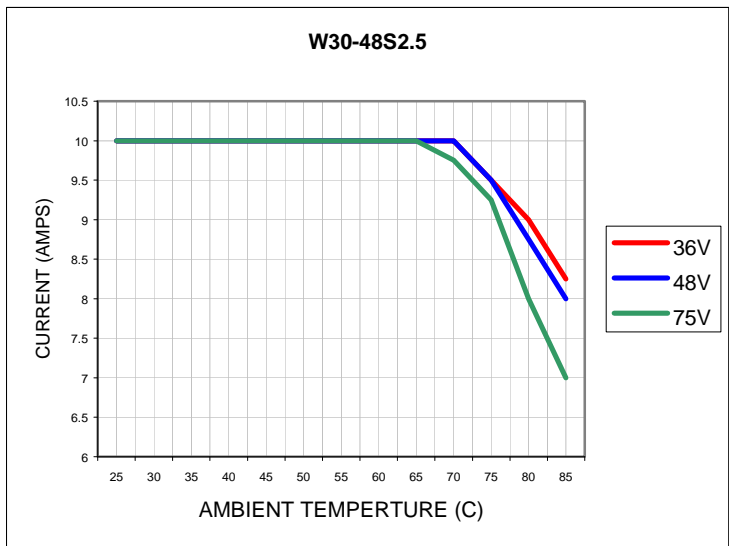
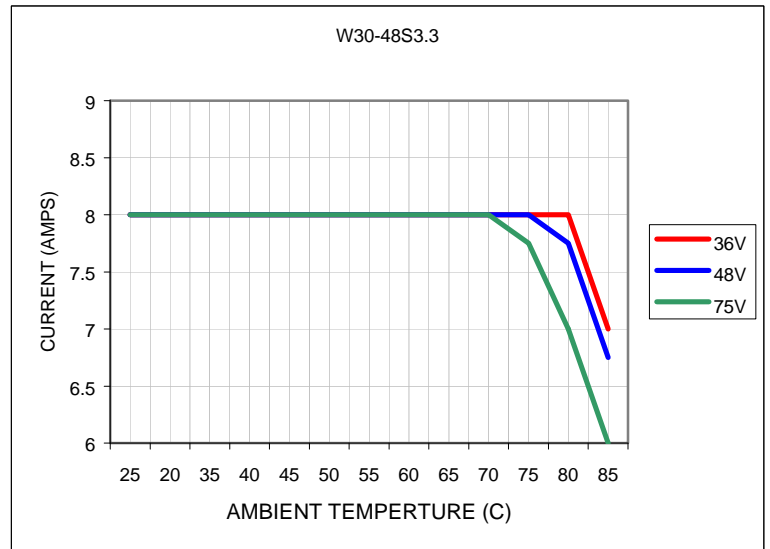
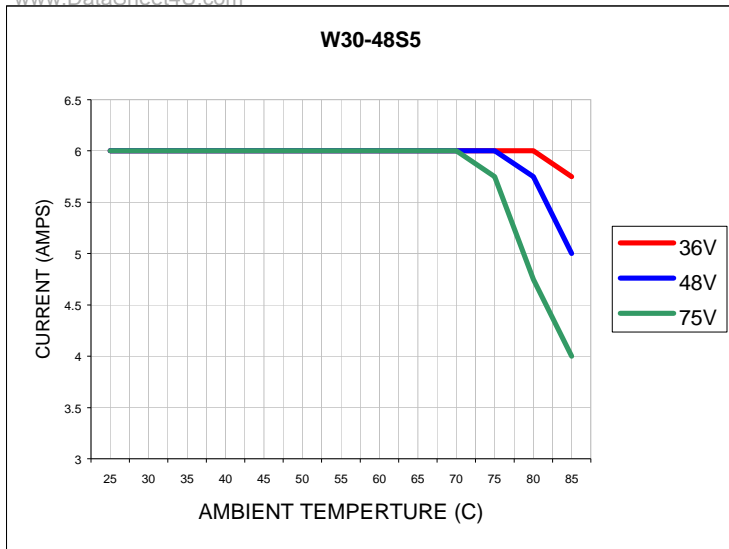

Note 1)

Units tested horizontally in a sealed enclosure (6"x6"x3"), within an environmental chamber.

Note 2)

Ambient temperature measured within sealed enclosure.

Note 3)

Derating occurs when a maximum temperature of 120°C is measured at the thermal switch.

W30-48 OUTPUT NOISE (PINOUT B)

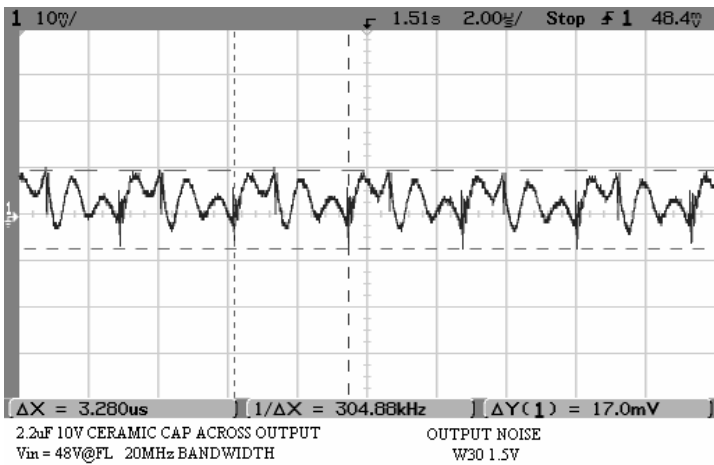
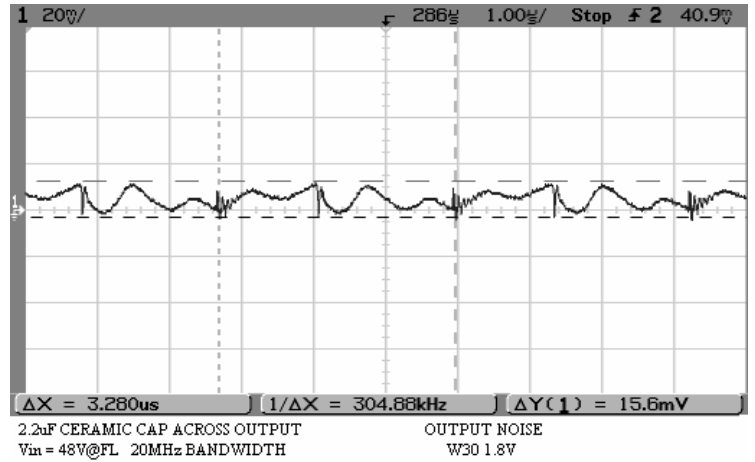
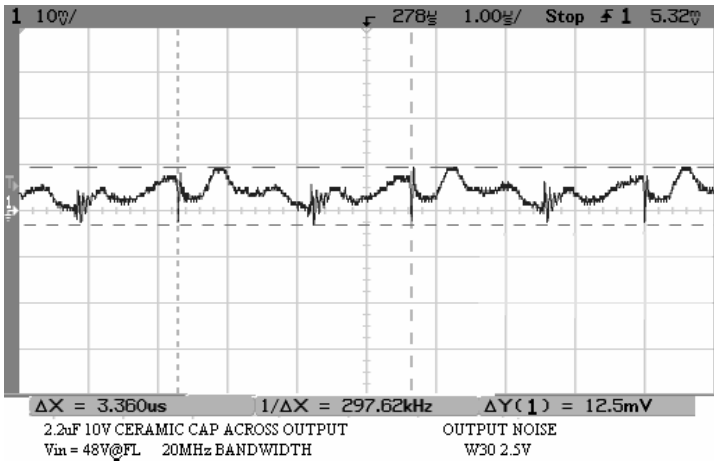
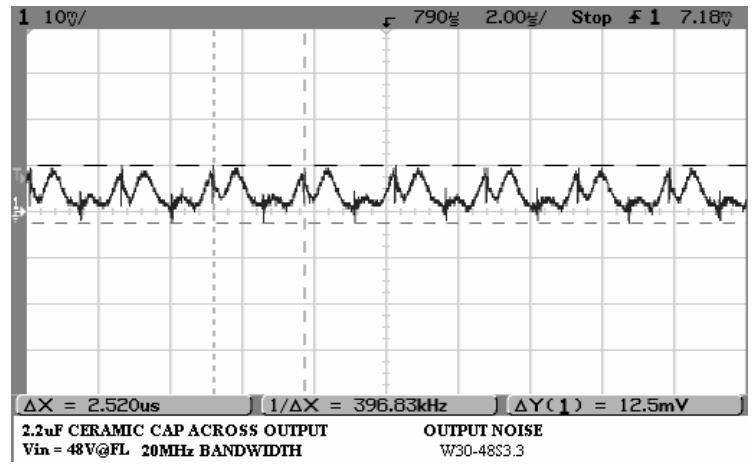
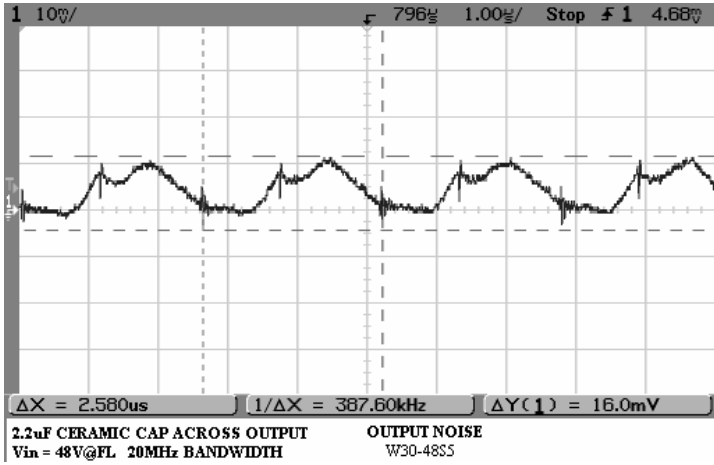

Note 1)
 With Pinout A 10uf tantalum caps across each output is recommended

W30-48 TRANSIENT RESPONSE

www.DataSheet4U.com

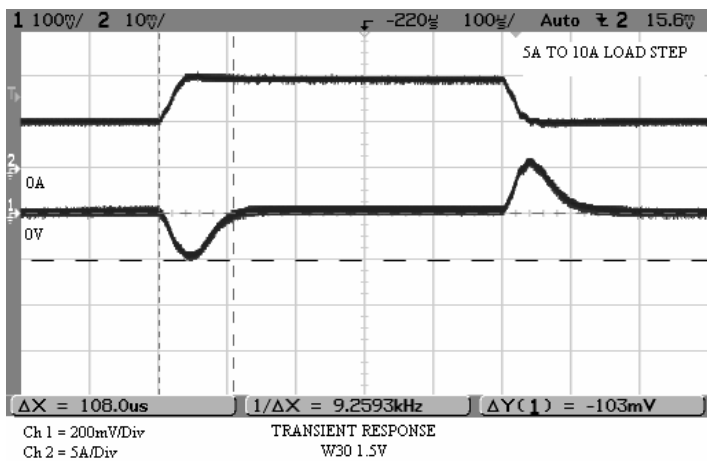
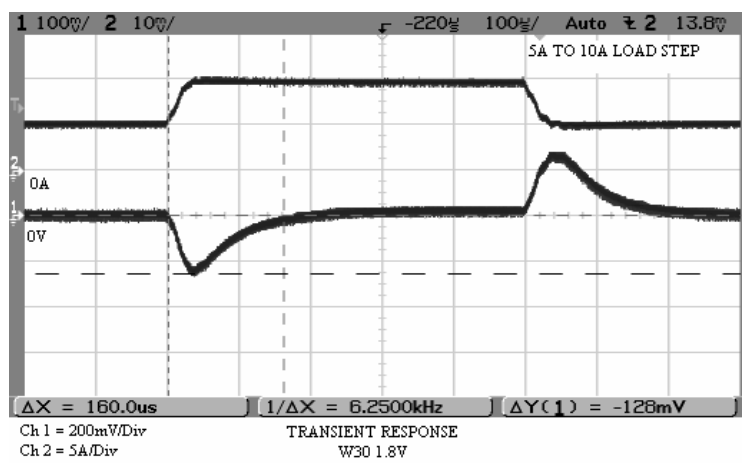
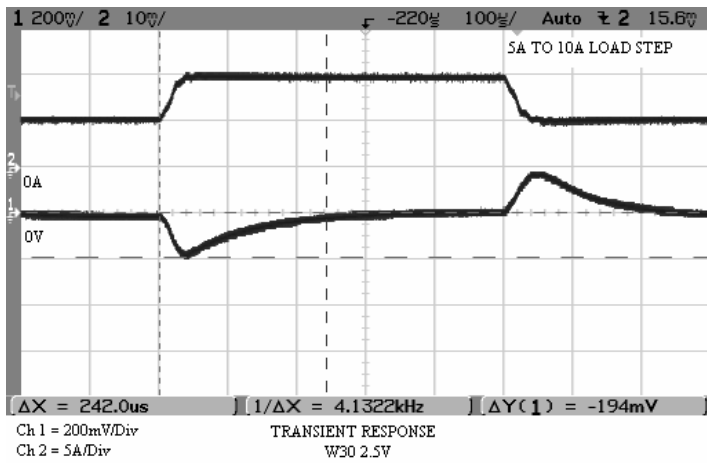
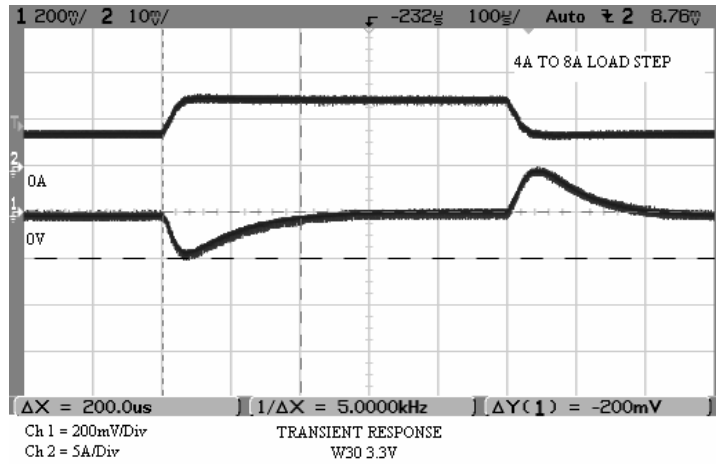
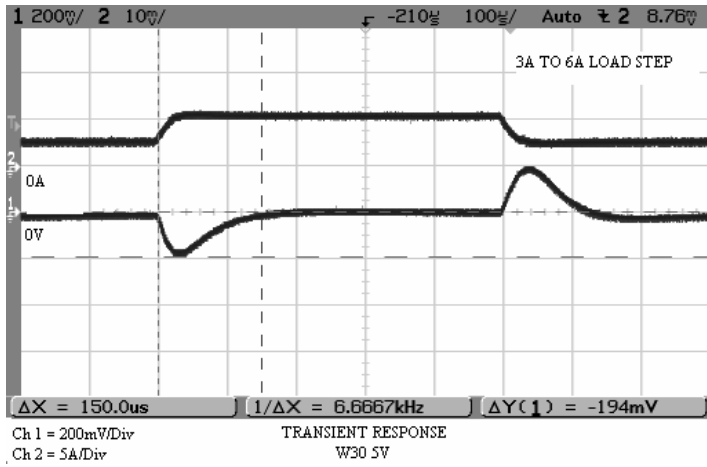

W30-48 TURN ON TIME

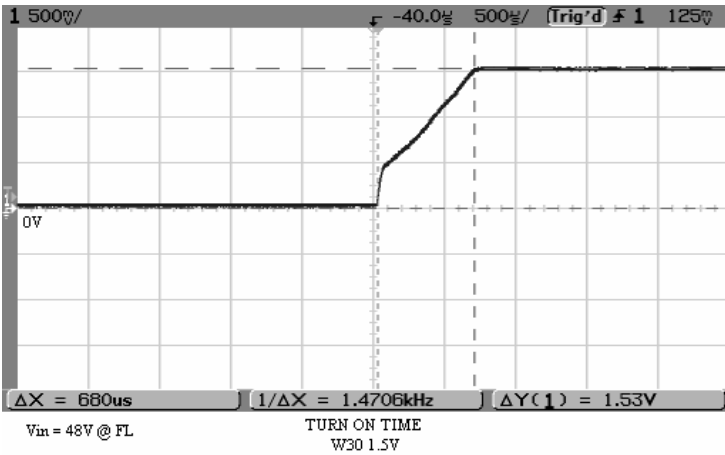
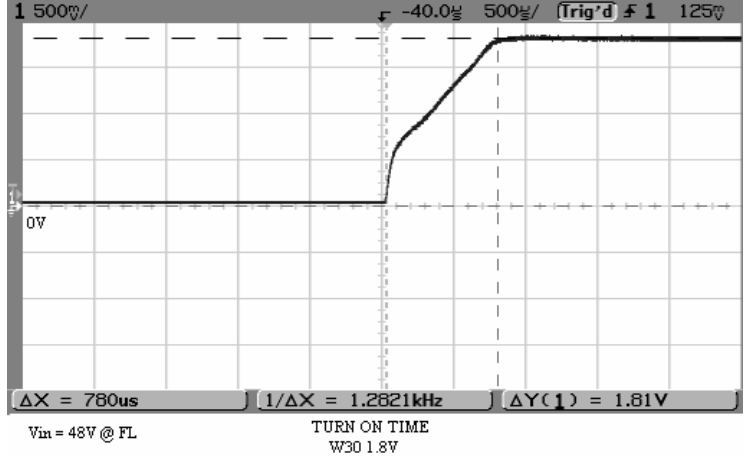
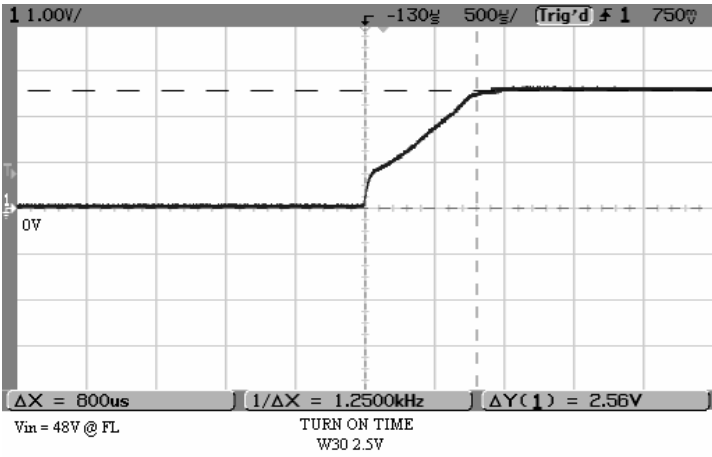
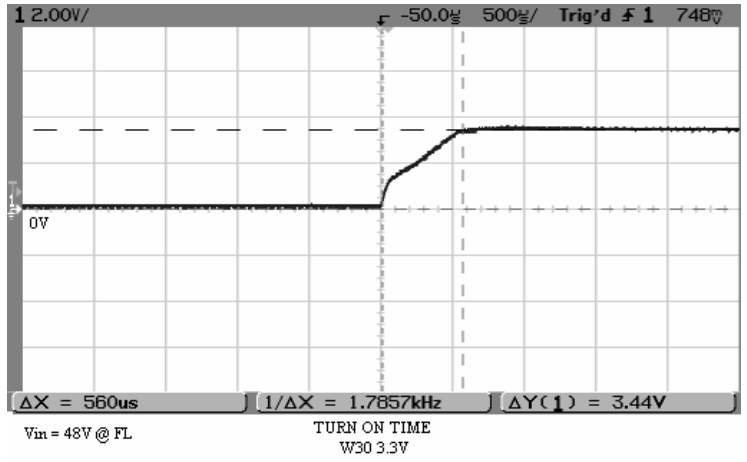
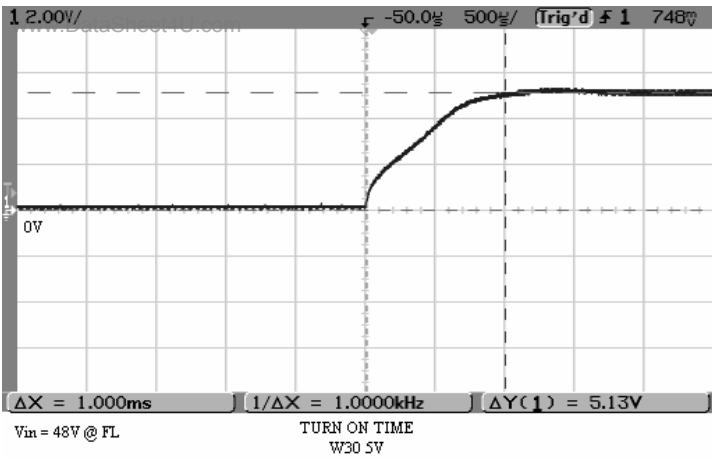

W30-48 TRIM CHARTS

www.DataSheet4U.com

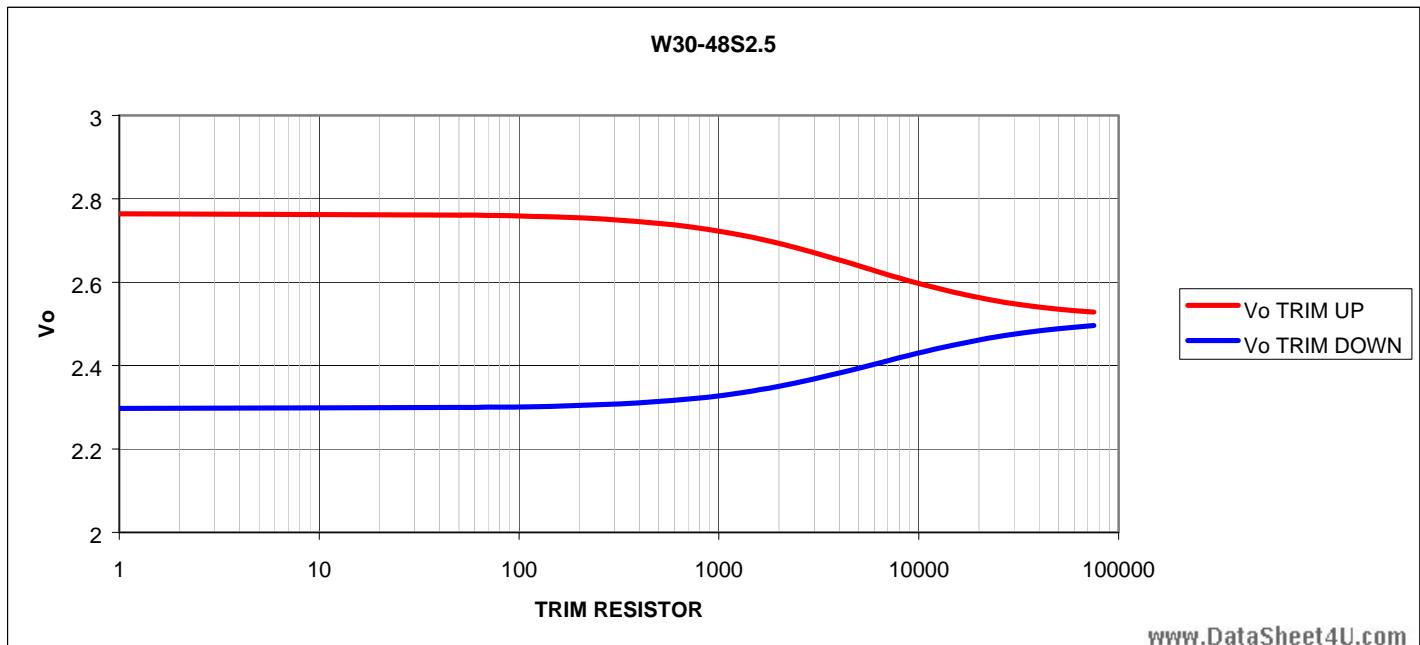
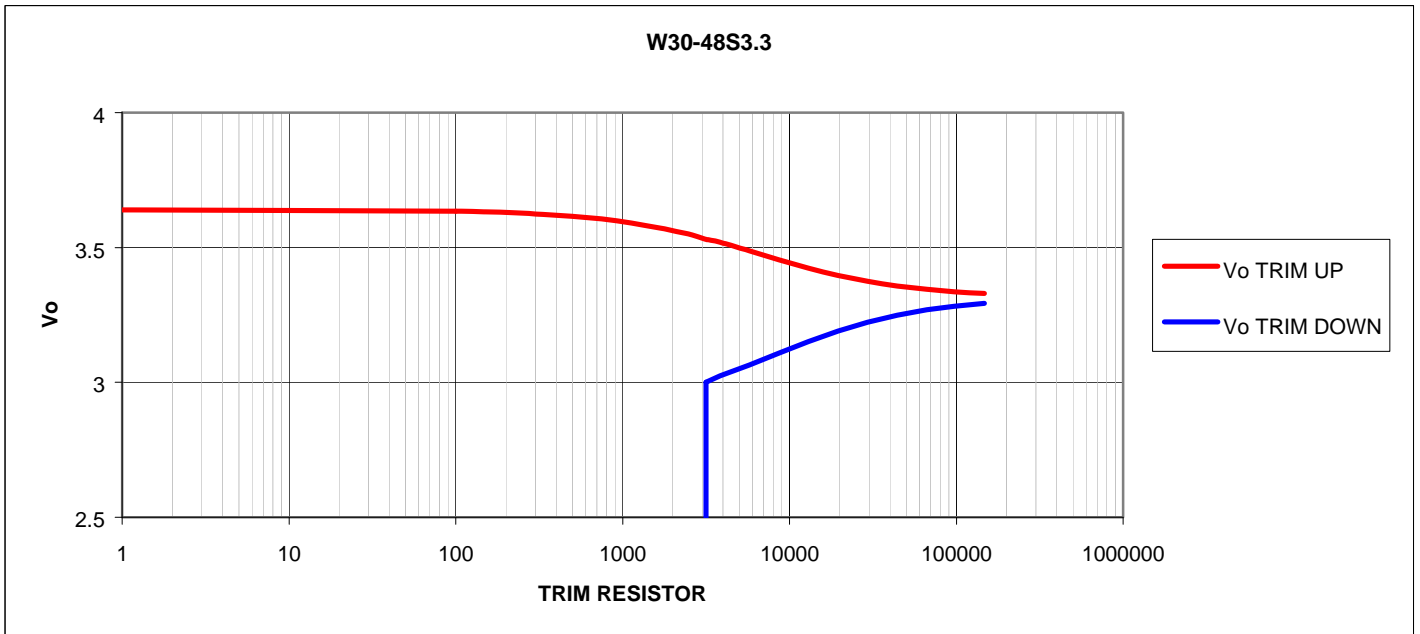
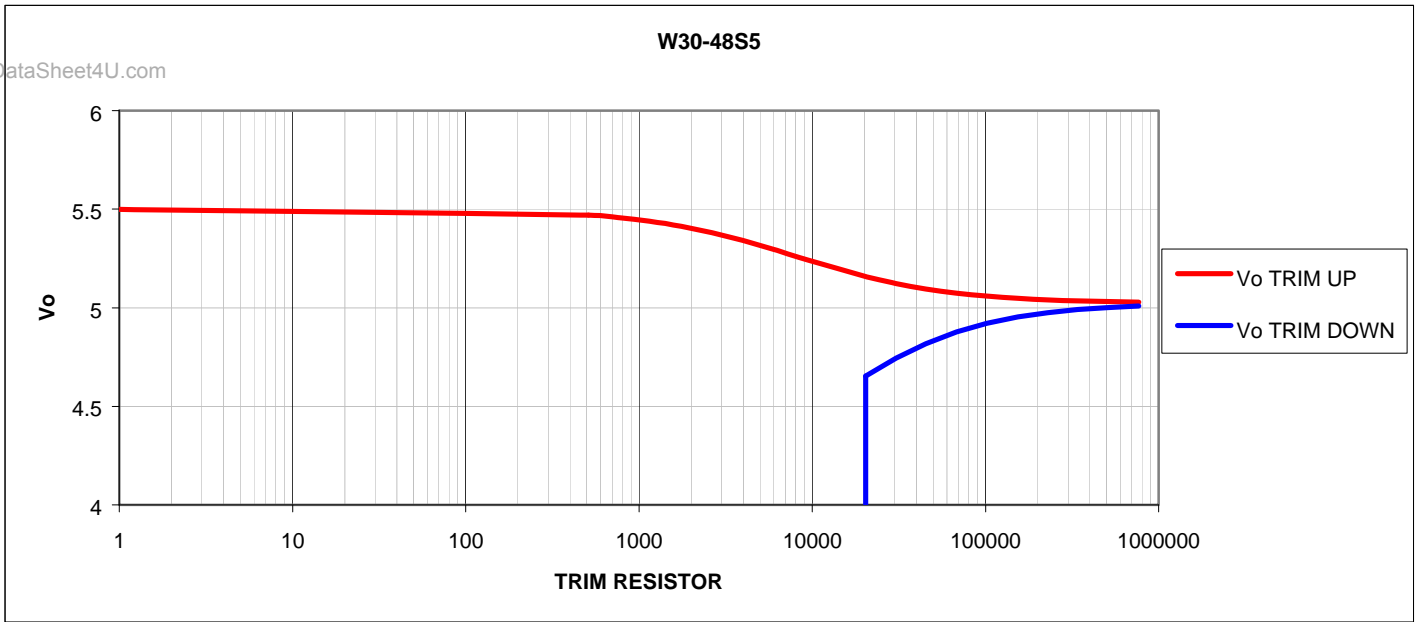

www.DataSheet4U.com

W30-48 TRIM CHARTS CONTINUED

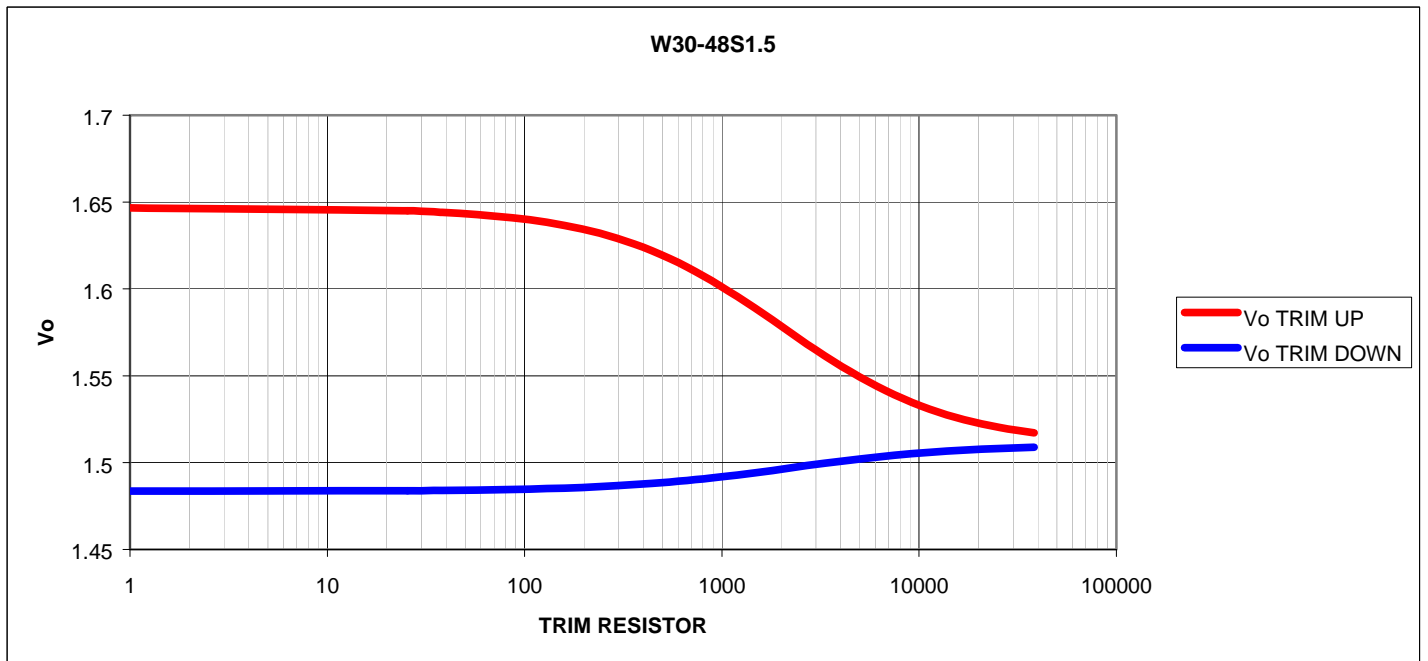
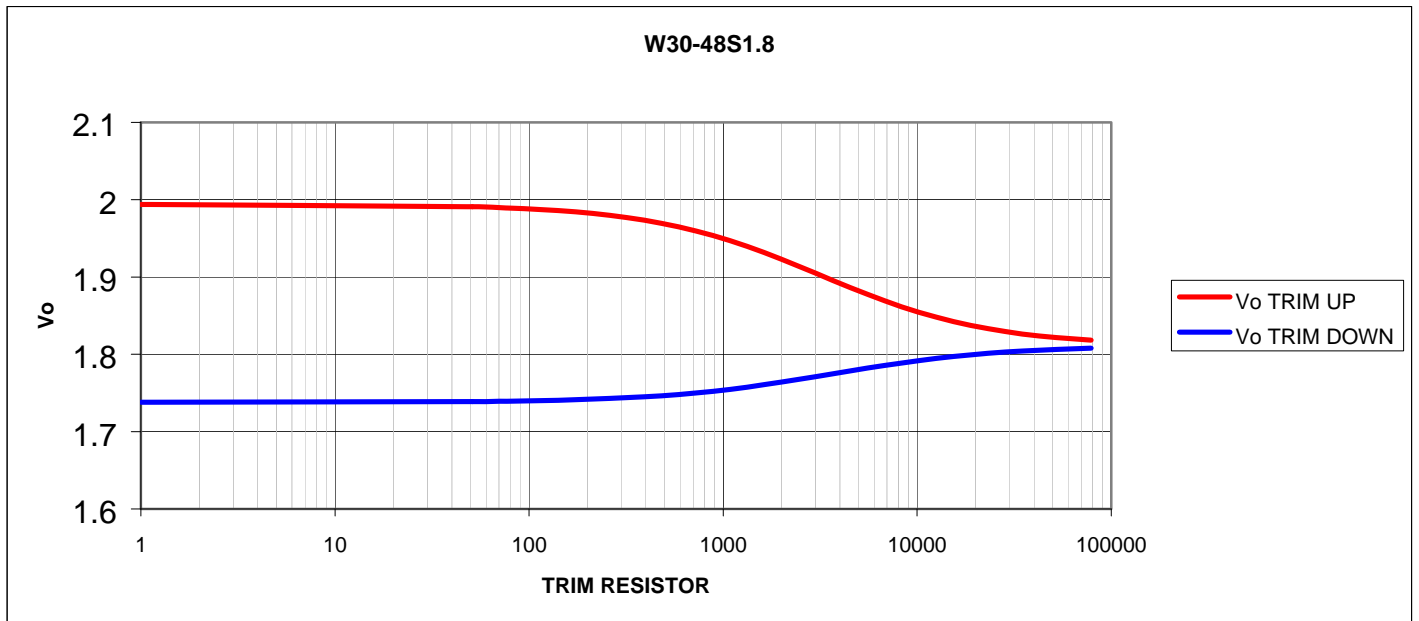

W30 PINOUTS

