

International
IR Rectifier

81CNQ...A SERIES

SCHOTTKY RECTIFIER
New GenIII D-61 Package

80 Amp

Major Ratings and Characteristics

Characteristics	81CNQ...A	Units
$I_{F(AV)}$ Rectangular waveform	80	A
V_{RRM} range	35 to 45	V
I_{FSM} @tp = 5 μ s sine	4600	A
V_F @40 Apk, $T_J = 125^\circ\text{C}$ (per leg)	0.54	V
T_J range	-55 to 175	$^\circ\text{C}$

Description/Features

The 81CNQ...A center tap Schottky rectifier module series has been optimized for low reverse leakage at high temperature. The proprietary barrier technology allows for reliable operation up to 175 $^\circ\text{C}$ junction temperature. Typical applications are in switching power supplies, converters, free-wheeling diodes, and reverse battery protection.

- 175 $^\circ\text{C}$ T_J operation
- Center tap module
- High purity, high temperature epoxy encapsulation for enhanced mechanical strength and moisture resistance
- Low forward voltage drop
- High frequency operation
- Guard ring for enhanced ruggedness and long term reliability
- *New fully transfer-mold low profile, small footprint, high current package*

Case Styles

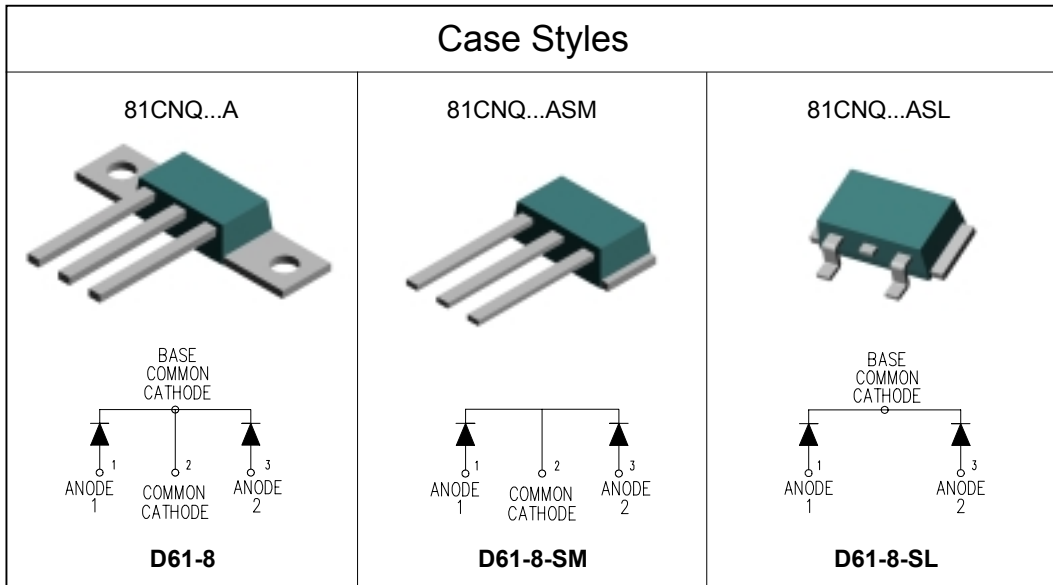

Voltage Ratings

Part number	81CNQ035A	81CNQ040A	81CNQ045A
V_R Max. DC Reverse Voltage (V)	35	40	45
V_{RWM} Max. Working Peak Reverse Voltage (V)			

Absolute Maximum Ratings

Parameters	81CNQ	Units	Conditions
$I_{F(AV)}$ Max. Average Forward Current * See Fig. 5	80	A	50% duty cycle @ $T_C = 141^\circ\text{C}$, rectangular waveform
I_{FSM} Max. Peak One Cycle Non-Repetitive Surge Current (Per Leg) * See Fig. 7	4600	A	Following any rated load condition and with rated V_{RRM} applied
	790		
E_{AS} Non-Repetitive Avalanche Energy (Per Leg)	54	mJ	$T_J = 25^\circ\text{C}$, $I_{AS} = 8$ Amps, $L = 1.7$ mH
I_{AR} Repetitive Avalanche Current (Per Leg)	8	A	Current decaying linearly to zero in 1 μsec Frequency limited by T_J max. $V_A = 1.5 \times V_R$ typical

Electrical Specifications

Parameters	81CNQ	Units	Conditions
V_{FM} Max. Forward Voltage Drop (Per Leg) * See Fig. 1 (1)	0.60	V	@ 40A
	0.74	V	@ 80A
	0.54	V	@ 40A
	0.66	V	@ 80A
I_{RM} Max. Reverse Leakage Current (Per Leg) * See Fig. 2 (1)	5	mA	$T_J = 25^\circ\text{C}$
	45	mA	$T_J = 125^\circ\text{C}$
C_T Max. Junction Capacitance (Per Leg)	2600	pF	$V_R = 5V_{DC}$, (test signal range 100Khz to 1Mhz) 25°C
L_S Typical Series Inductance (Per Leg)	5.5	nH	Measured lead to lead 5mm from package body
dv/dt Max. Voltage Rate of Change (Rated V_R)	10000	V/ μs	

(1) Pulse Width < 300 μs , Duty Cycle <2%

Thermal-Mechanical Specifications

Parameters	81CNQ	Units	Conditions
T_J Max. Junction Temperature Range	-55 to 175	$^\circ\text{C}$	
T_{stg} Max. Storage Temperature Range	-55 to 175	$^\circ\text{C}$	
R_{thJC} Max. Thermal Resistance Junction to Case (Per Leg)	0.85	$^\circ\text{C}/\text{W}$	DC operation * See Fig. 4
R_{thJC} Max. Thermal Resistance Junction to Case (Per Package)	0.42	$^\circ\text{C}/\text{W}$	DC operation
R_{thCS} Typical Thermal Resistance, Case to Heatsink (D61-8 Only)	0.30	$^\circ\text{C}/\text{W}$	Mounting surface, smooth and greased Device flatness < 5 mils
wt Approximate Weight	7.8(0.28)	g(oz.)	
T Mounting Torque (D61-8 Only)	Min.	40(35)	Kg-cm (lbf-in)
	Max.	58(50)	

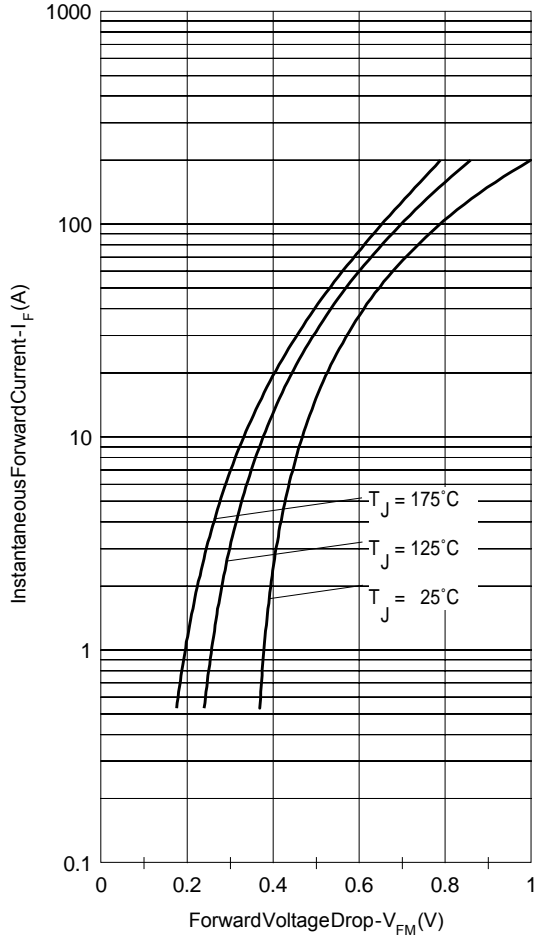

Fig. 1 - Max. Forward Voltage Drop Characteristics (Per Leg)

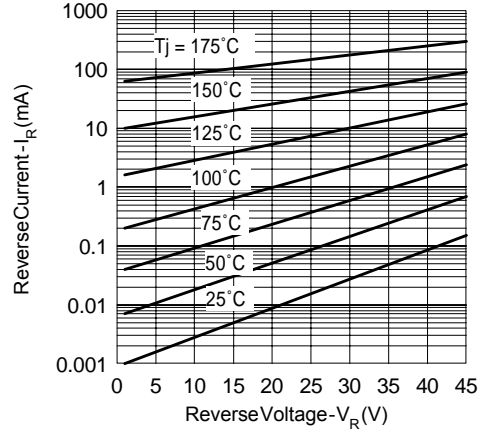

Fig. 2 - Typical Values Of Reverse Current Vs. Reverse Voltage (Per Leg)

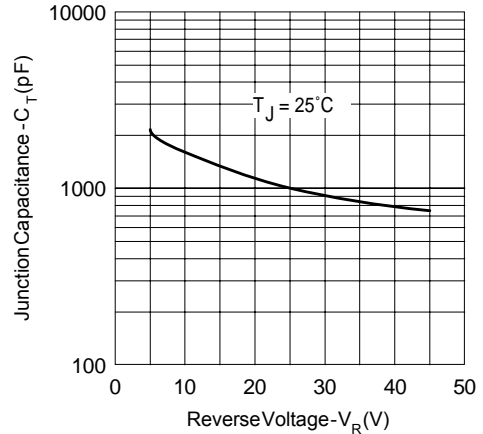

Fig. 3 - Typical Junction Capacitance Vs. Reverse Voltage (Per Leg)

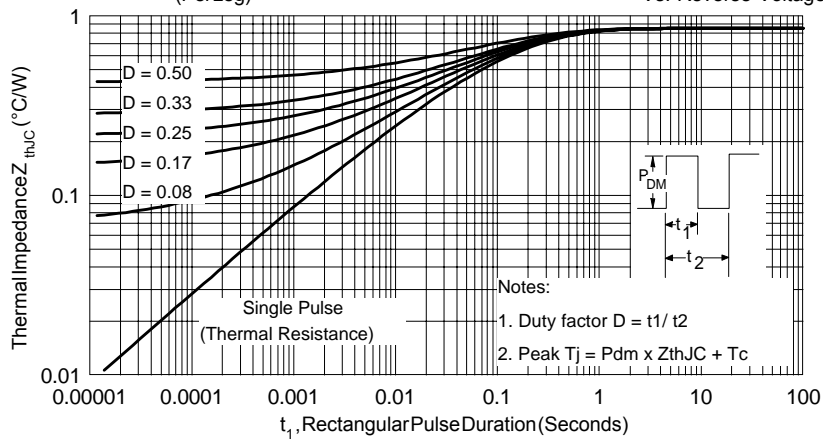

Fig. 4 - Max. Thermal Impedance Z_{thJC} Characteristics (Per Leg)

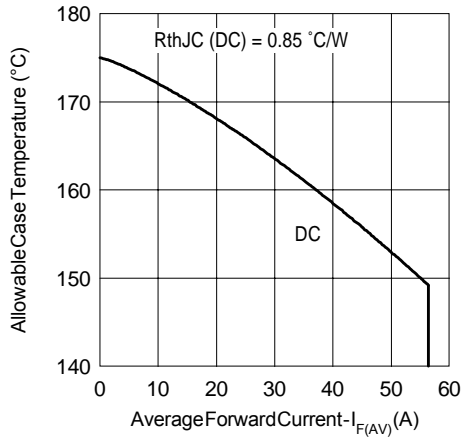

Fig. 5 - Max. Allowable Case Temperature Vs. Average Forward Current (Per Leg)

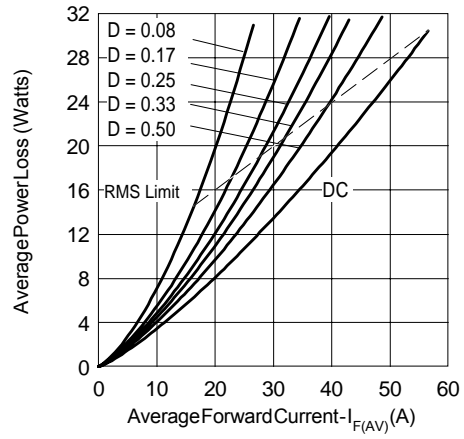

Fig. 6 - Forward Power Loss Characteristics (Per Leg)

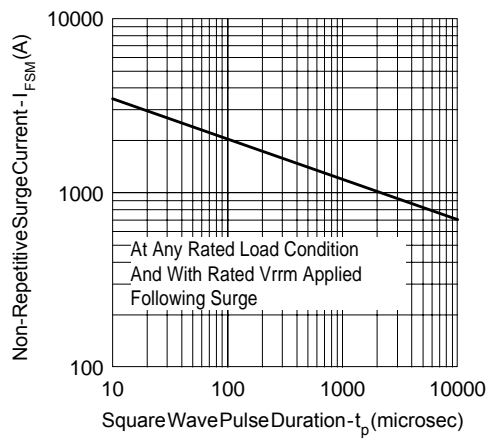

Fig. 7 - Max. Non-Repetitive Surge Current (Per Leg)

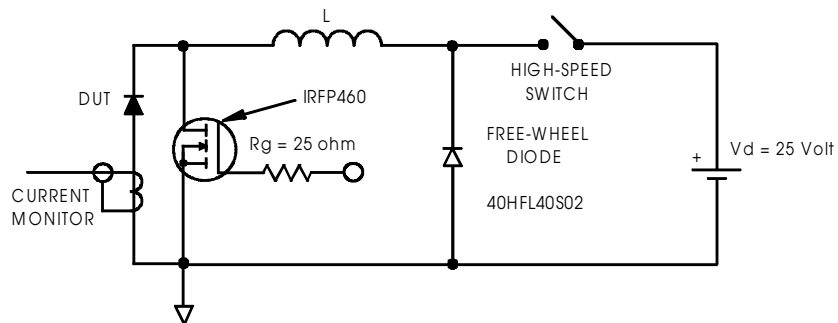
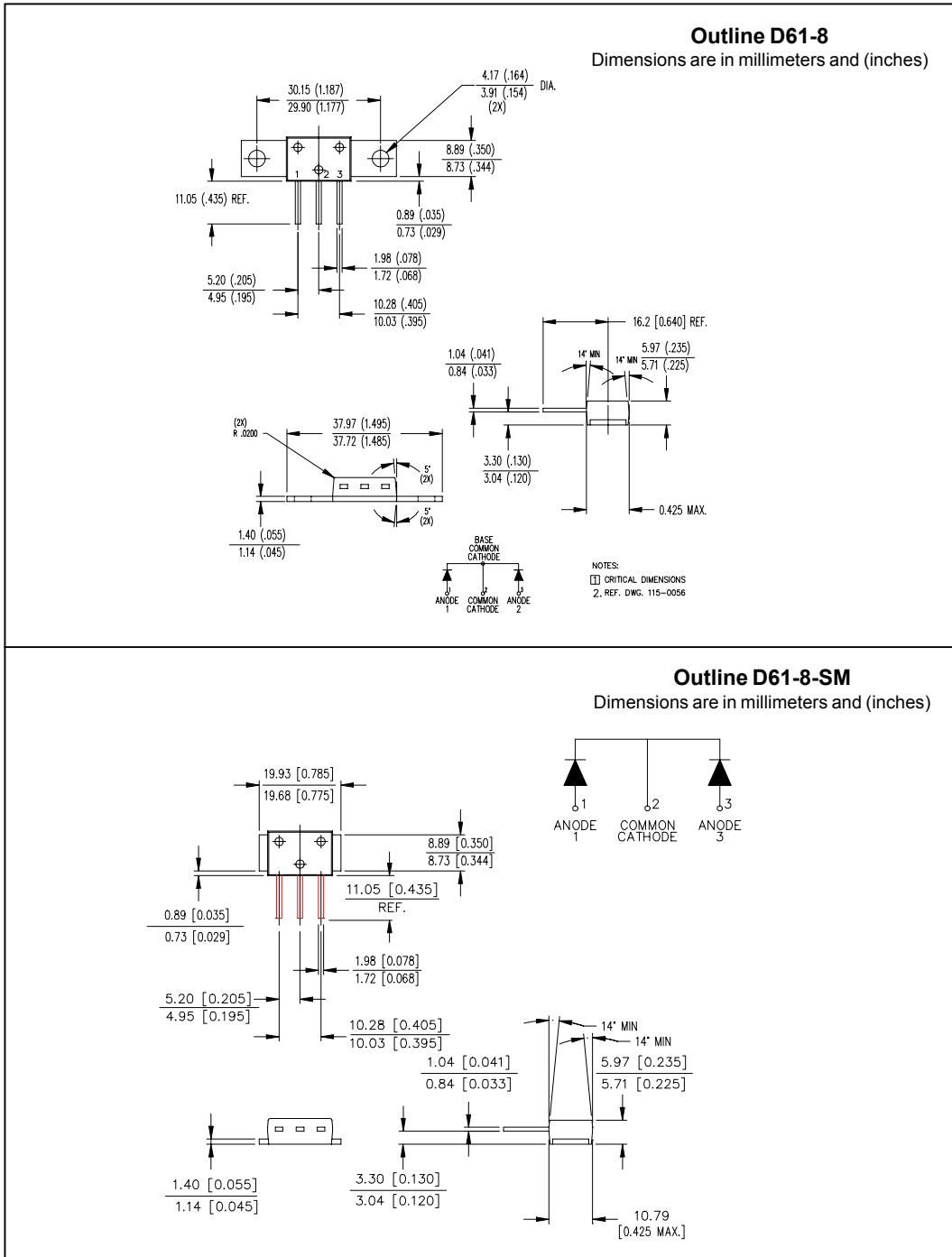
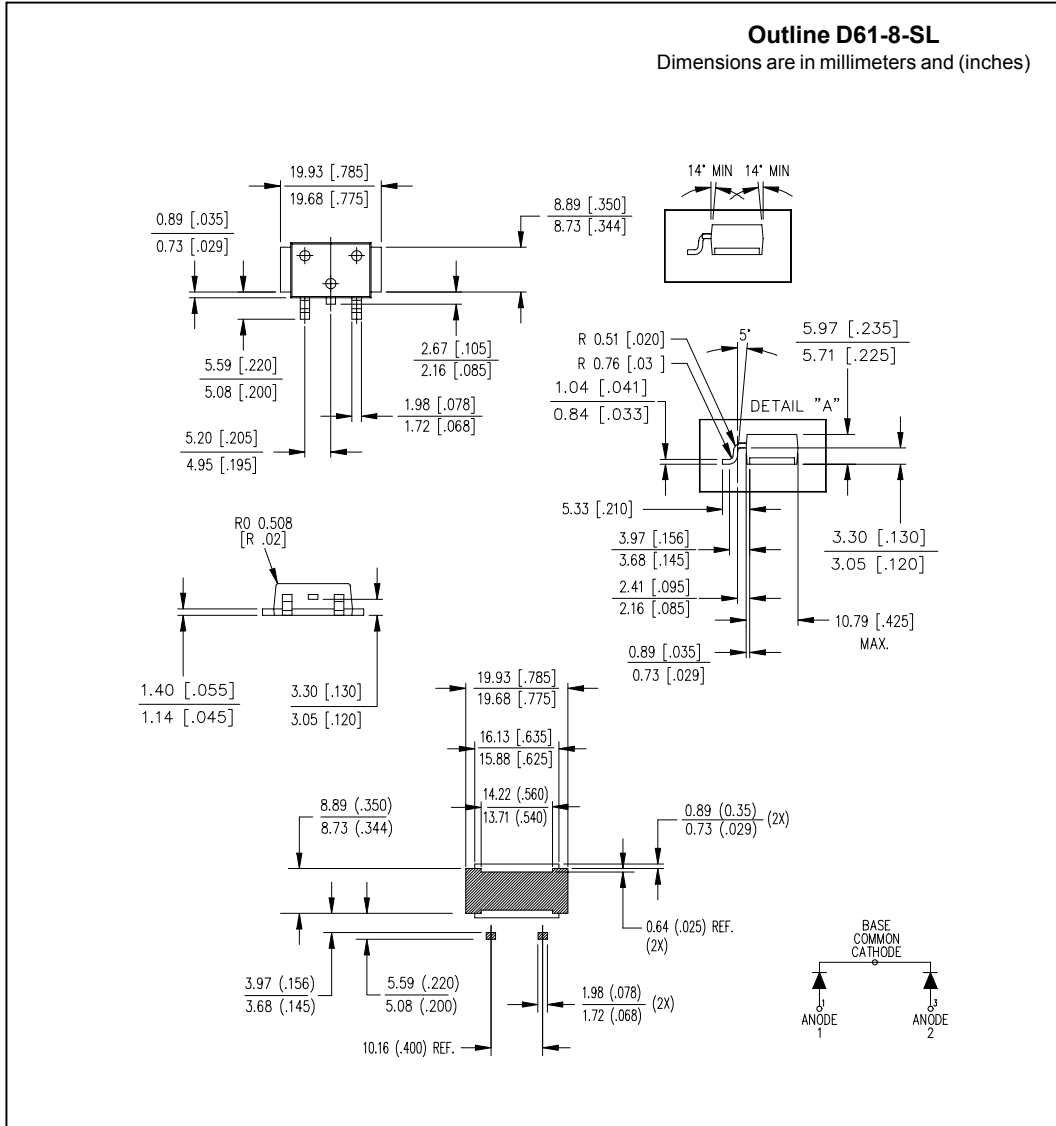

Fig. 8 - Unclamped Inductive Test Circuit

Outline Table



Outline Table



Part Marking Information

EXAMPLE: THIS IS A 81CNQ045A WITH
 LOT CODE 89 09
 ASSEMBLED ON WW 45, 2000
 IN THE ASSEMBLY LINE "A"

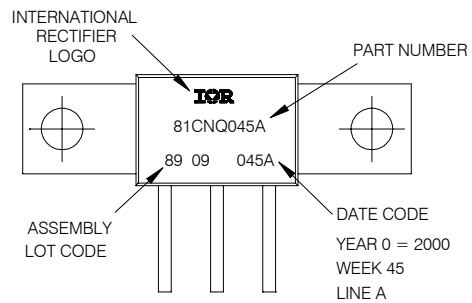

D61-8

EXAMPLE: THIS IS A 81CNQ045ASM WITH
 LOT CODE 89 09
 ASSEMBLED ON WW 45, 2000
 IN THE ASSEMBLY LINE "A"

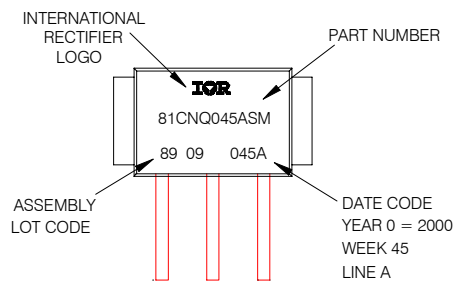

D61-8-SM

EXAMPLE: THIS IS A 81CNQ045ASL WITH
 LOT CODE 89 09
 ASSEMBLED ON WW 45, 2000
 IN THE ASSEMBLY LINE "A"

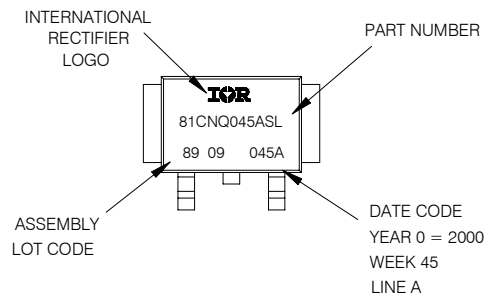

D61-8-SL

81CNQ...A Series

Bulletin 20040 rev. A 09/01

International
IOR Rectifier

Data and specifications subject to change without notice.
This product has been designed and qualified for Industrial Level.
Qualification Standards can be found on IR's Web site.

International
IOR Rectifier

IR WORLD HEADQUARTERS: 233 Kansas St., El Segundo, California 90245, USA Tel: (310) 252-7105
TAC Fax: (310) 252-7309
Visit us at www.irf.com for sales contact information. 09/01