

## Dual Enhancement Mode Field Effect Transistor (N and P Channel)

### FEATURES

- 60V, 5.6A,  $R_{DS(ON)} = 45m\Omega$  @  $V_{GS} = 10V$ .  
 $R_{DS(ON)} = 75m\Omega$  @  $V_{GS} = 4.5V$ .
- -60V, -3.3A,  $R_{DS(ON)} = 130m\Omega$  @  $V_{GS} = -10V$ .  
 $R_{DS(ON)} = 180m\Omega$  @  $V_{GS} = -4.5V$ .
- Super high dense cell design for extremely low  $R_{DS(ON)}$ .
- High power and current handing capability.
- Lead free product is acquired.

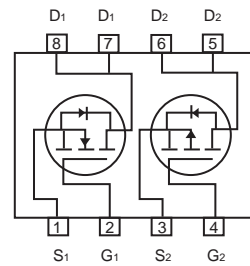
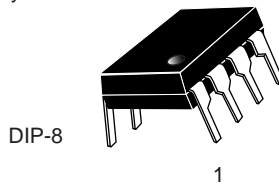

### ABSOLUTE MAXIMUM RATINGS $T_A = 25^\circ C$ unless otherwise noted

Parameter	Symbol	N-Channel	P-Channel	Units
Drain-Source Voltage	$V_{DS}$	60	-60	V
Gate-Source Voltage	$V_{GS}$	$\pm 20$	$\pm 20$	V
Drain Current-Continuous	$I_D$	5.6	-3.3	A
Drain Current-Pulsed <sup>a</sup>	$I_{DM}$	20	-15	A
Maximum Power Dissipation	$P_D$	2.5		W
Operating and Store Temperature Range	$T_J, T_{stg}$	-55 to 150		$^\circ C$

### Thermal Characteristics

Parameter	Symbol	Limit	Units
Thermal Resistance, Junction-to-Ambient <sup>b</sup>	$R_{\theta JA}$	50	$^\circ C/W$



## N-Channel Electrical Characteristics T<sub>A</sub> = 25 C unless otherwise noted

Parameter	Symbol	Test Condition	Min	Typ	Max	Units
<b>Off Characteristics</b>						
Drain-Source Breakdown Voltage	$BV_{DSS}$	$V_{GS} = 0V, I_D = 250\mu A$	60			V
Zero Gate Voltage Drain Current	$I_{DSS}$	$V_{DS} = 60V, V_{GS} = 0V$			1	$\mu A$
Gate Body Leakage Current, Forward	$I_{GSSF}$	$V_{GS} = 20V, V_{DS} = 0V$			100	nA
Gate Body Leakage Current, Reverse	$I_{GSSR}$	$V_{GS} = -20V, V_{DS} = 0V$			-100	nA
<b>On Characteristics</b>						
Gate Threshold Voltage	$V_{GS(th)}$	$V_{GS} = V_{DS}, I_D = 250\mu A$	1		3	V
Static Drain-Source On-Resistance	$R_{DS(on)}$	$V_{GS} = 10V, I_D = 5.6A$		35	45	$m\Omega$
		$V_{GS} = 4.5V, I_D = 4.4A$		60	75	$m\Omega$
<b>Dynamic Characteristics <sup>c</sup></b>						
Forward Transconductance	$g_{FS}$	$V_{DS} = 15V, I_D = 5.6A$		14		S
Input Capacitance	$C_{iss}$	$V_{DS} = 30V, V_{GS} = 0V, f = 1.0 MHz$		750		pF
Output Capacitance	$C_{oss}$			105		pF
Reverse Transfer Capacitance	$C_{rss}$			65		pF
<b>Switching Characteristics <sup>c</sup></b>						
Turn-On Delay Time	$t_{d(on)}$	$V_{DD} = 30V, I_D = 4.4A, V_{GS} = 10V, R_{GEN} = 1\Omega$		15	30	ns
Turn-On Rise Time	$t_r$			4	15	ns
Turn-Off Delay Time	$t_{d(off)}$			37	80	ns
Turn-Off Fall Time	$t_f$			5	15	ns
Total Gate Charge	$Q_g$	$V_{DS} = 30V, I_D = 5.6A, V_{GS} = 10V$		22	29	nC
Gate-Source Charge	$Q_{gs}$			3.0		nC
Gate-Drain Charge	$Q_{gd}$			4.5		nC
<b>Drain-Source Diode Characteristics and Maximum Ratings</b>						
Drain-Source Diode Forward Current	$I_S$				5.6	A
Drain-Source Diode Forward Voltage <sup>b</sup>	$V_{SD}$	$V_{GS} = 0V, I_S = 1.3A$			1.2	V
<b>Notes :</b> a.Repetitive Rating : Pulse width limited by maximum junction temperature. b.Pulse Test : Pulse Width $\leq 300\mu s$ , Duty Cycle $\leq 2\%$ . c.Guaranteed by design, not subject to production testing.						



## P-Channel Electrical Characteristics T<sub>A</sub> = 25 C unless otherwise noted

Parameter	Symbol	Test Condition	Min	Typ	Max	Units
<b>Off Characteristics</b>						
Drain-Source Breakdown Voltage	BV <sub>DSS</sub>	V <sub>GS</sub> = 0V, I <sub>D</sub> = -250μA	-60			V
Zero Gate Voltage Drain Current	I <sub>DSS</sub>	V <sub>DS</sub> = -60V, V <sub>GS</sub> = 0V			-1	μA
Gate Body Leakage Current, Forward	I <sub>GSSF</sub>	V <sub>GS</sub> = 20V, V <sub>DS</sub> = 0V			100	nA
Gate Body Leakage Current, Reverse	I <sub>GSSR</sub>	V <sub>GS</sub> = -20V, V <sub>DS</sub> = 0V			-100	nA
<b>On Characteristics</b>						
Gate Threshold Voltage	V <sub>GS(th)</sub>	V <sub>GS</sub> = V <sub>DS</sub> , I <sub>D</sub> = -250μA	-1		-3	V
Static Drain-Source On-Resistance	R <sub>DS(on)</sub>	V <sub>GS</sub> = -10V, I <sub>D</sub> = -3.3A		105	130	mΩ
		V <sub>GS</sub> = -4.5V, I <sub>D</sub> = -2.6A		135	180	mΩ
<b>Dynamic Characteristics <sup>c</sup></b>						
Forward Transconductance	g <sub>FS</sub>	V <sub>DS</sub> = -15V, I <sub>D</sub> = -3.3A		8		S
Input Capacitance	C <sub>iss</sub>	V <sub>DS</sub> = -30V, V <sub>GS</sub> = 0V, f = 1.0 MHz		890		pF
Output Capacitance	C <sub>oss</sub>			85		pF
Reverse Transfer Capacitance	C <sub>rss</sub>			85		pF
<b>Switching Characteristics <sup>c</sup></b>						
Turn-On Delay Time	t <sub>d(on)</sub>	V <sub>DD</sub> = -30V, I <sub>D</sub> = -1A, V <sub>GS</sub> = -10V, R <sub>GEN</sub> = 6Ω		11	20	ns
Turn-On Rise Time	t <sub>r</sub>			3	5	ns
Turn-Off Delay Time	t <sub>d(off)</sub>			30	60	ns
Turn-Off Fall Time	t <sub>f</sub>			4	10	ns
Total Gate Charge	Q <sub>g</sub>	V <sub>DS</sub> = -30V, I <sub>D</sub> = -3.3A, V <sub>GS</sub> = -10V		10.7	14	nC
Gate-Source Charge	Q <sub>gs</sub>			2.1		nC
Gate-Drain Charge	Q <sub>gd</sub>			1.1		nC
<b>Drain-Source Diode Characteristics and Maximum Ratings</b>						
Drain-Source Diode Forward Current	I <sub>S</sub>				-3.3	A
Drain-Source Diode Forward Voltage <sup>b</sup>	V <sub>SD</sub>	V <sub>GS</sub> = 0V, I <sub>S</sub> = -1.3A			-1.2	V
<b>Notes :</b> a.Repetitive Rating : Pulse width limited by maximum junction temperature. b.Pulse Test : Pulse Width ≤ 300μs, Duty Cycle ≤ 2%. c.Guaranteed by design, not subject to production testing.						



## N-CHANNEL

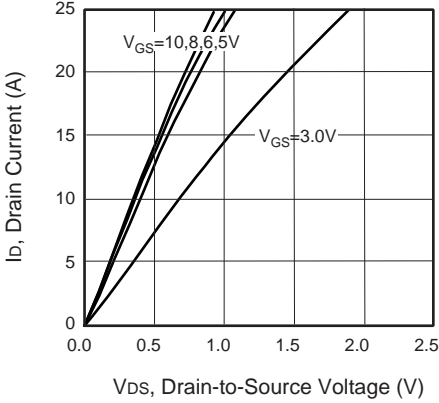

Figure 1. Output Characteristics

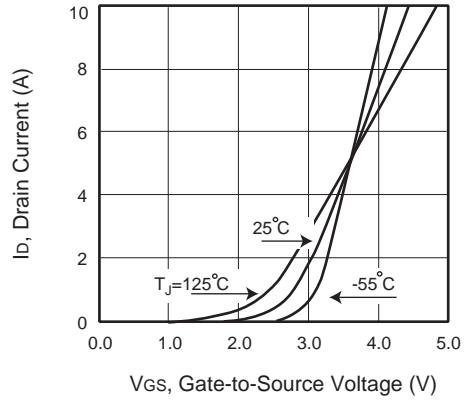

Figure 2. Transfer Characteristics

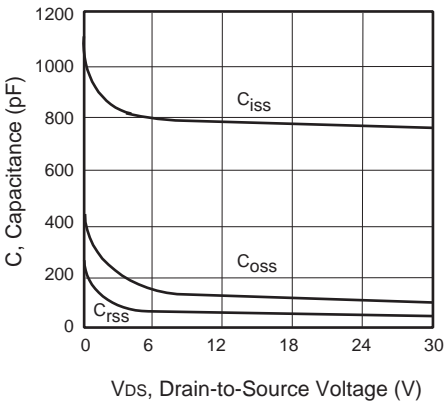

Figure 3. Capacitance

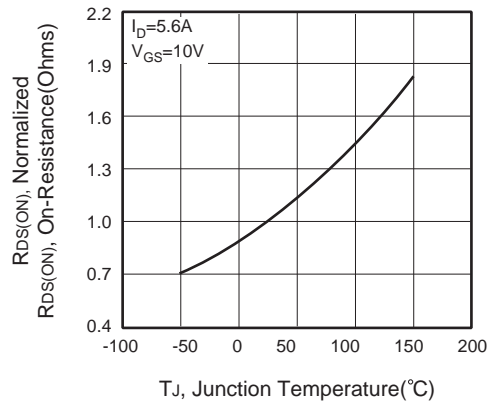

Figure 4. On-Resistance Variation with Temperature

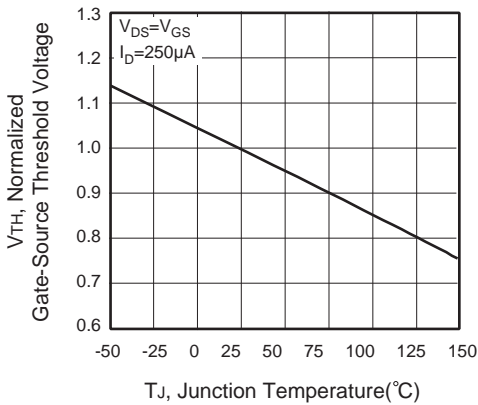

Figure 5. Gate Threshold Variation with Temperature

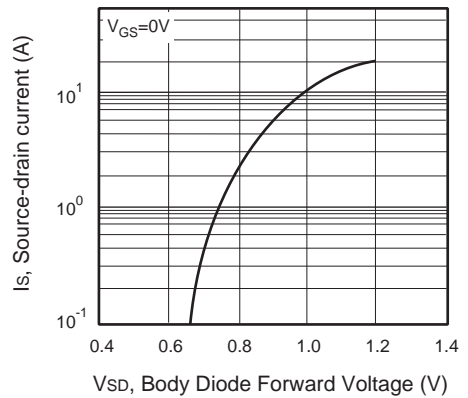

Figure 6. Body Diode Forward Voltage Variation with Source Current



## P-CHANNEL

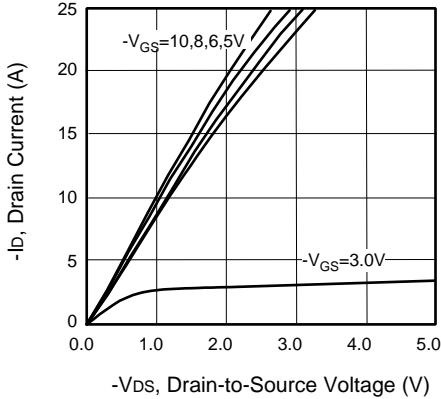

Figure 7. Output Characteristics

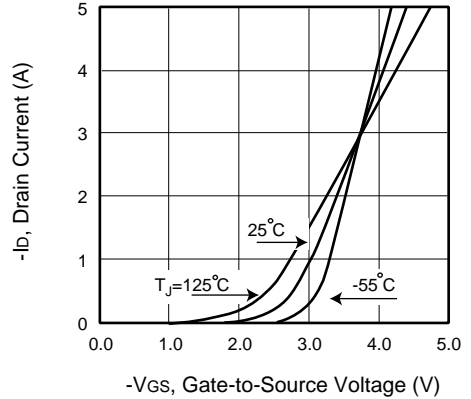

Figure 8. Transfer Characteristics

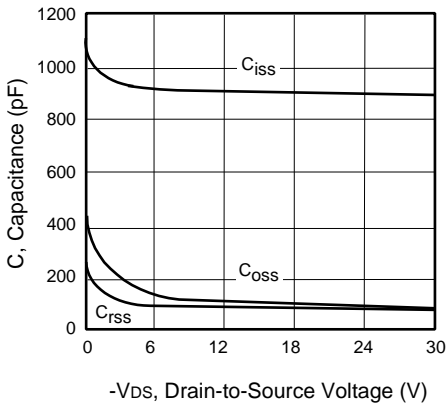

Figure 9. Capacitance

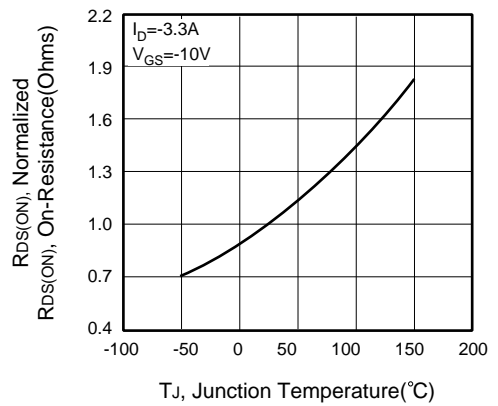

Figure 10. On-Resistance Variation with Temperature

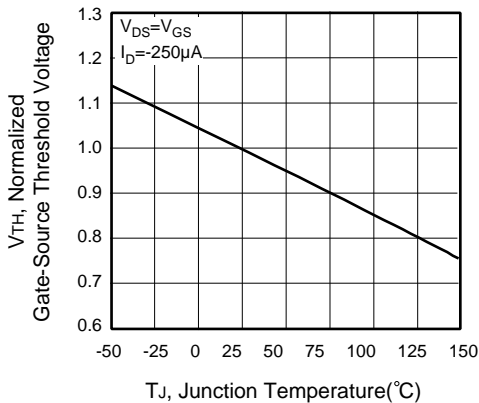

Figure 11. Gate Threshold Variation with Temperature

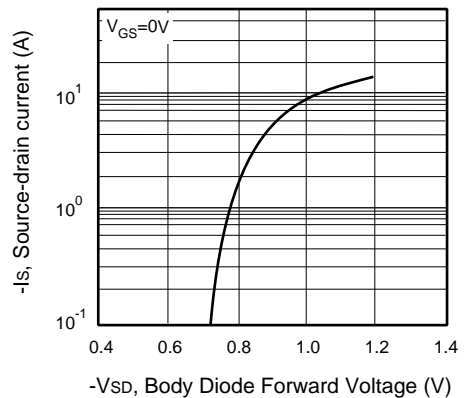

Figure 12. Body Diode Forward Voltage Variation with Source Current



## N-CHANNEL

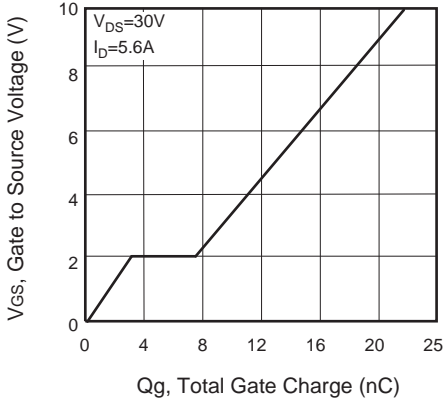

Figure 13. Gate Charge

## P-CHANNEL

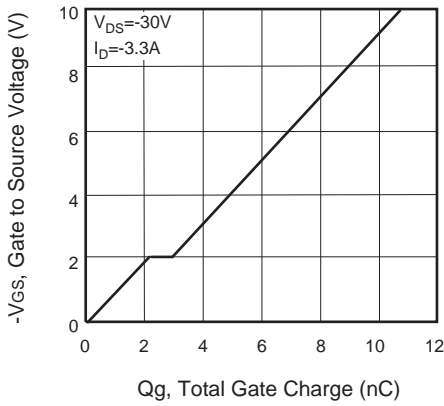

Figure 15. Gate Charge

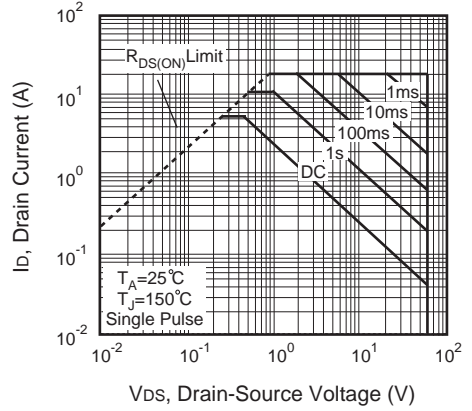

Figure 14. Maximum Safe Operating Area

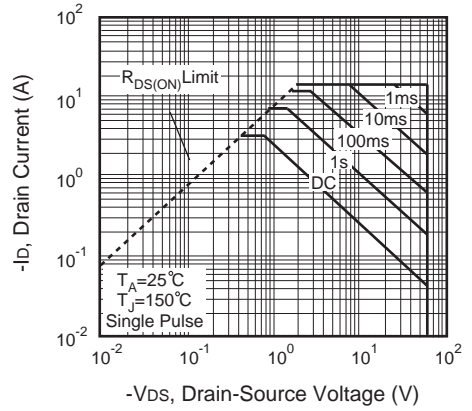

Figure 16. Maximum Safe Operating Area

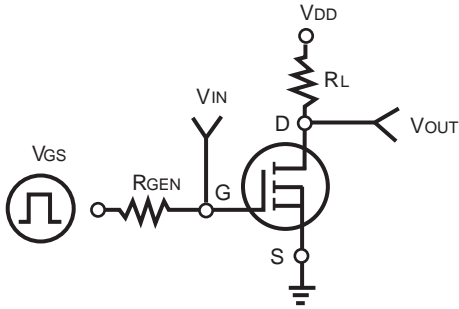

Figure 17. Switching Test Circuit

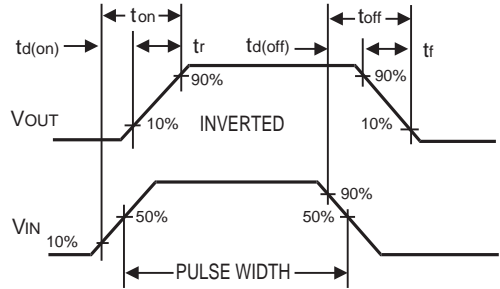

Figure 18. Switching Waveforms

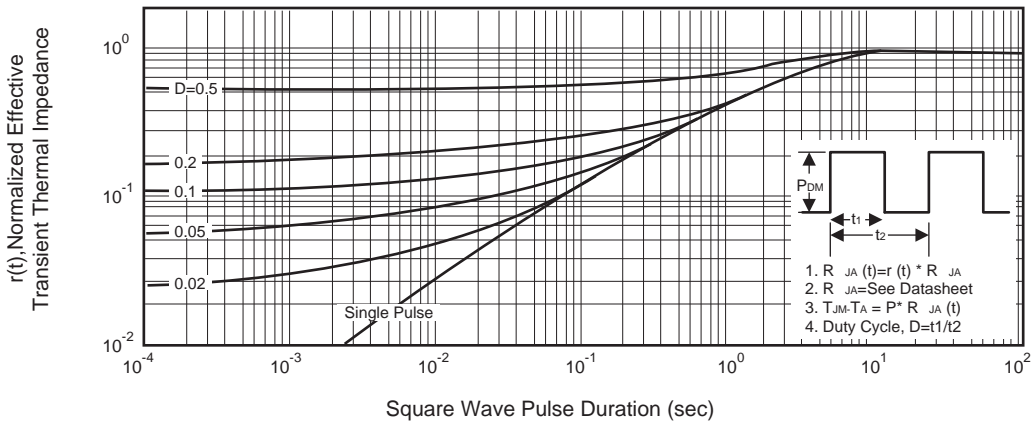

Figure 19. Normalized Thermal Transient Impedance Curve