

## CAPACITOR OUTLINE DRAWINGS

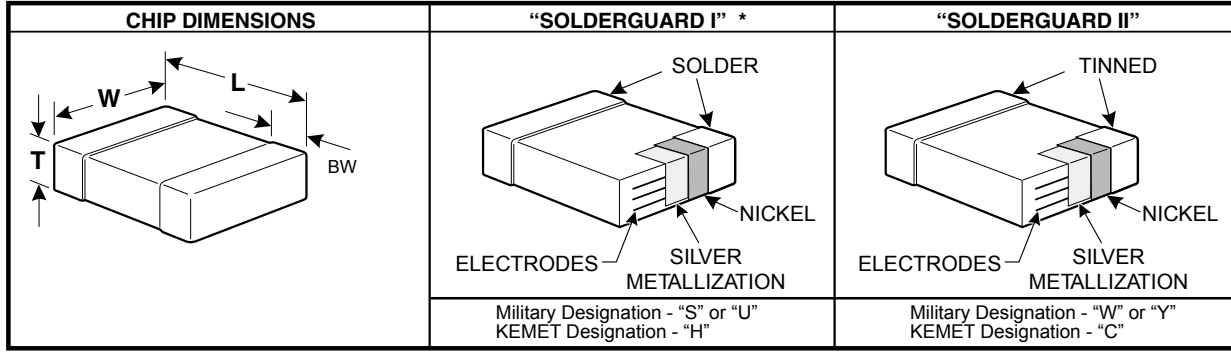

## DIMENSIONS—MILLIMETERS AND (INCHES)

STYLE	KEMET SIZE CODE	L	W	T		BW
				MIN.	MAX.	
CDR01	C0805	2.03 ±.38 (.080 ±.015)	1.27 ±.38 (.050 ±.015)	.56 (.022)	1.40 (.055)	.51 ± 0.25 (.020 ±.010)
CDR02	C1805	4.57 ±.38 (.180 ±.015)	1.27 ±.38 (.050 ±.015)	.56 (.022)	1.40 (.055)	.51 ± 0.25 (.020 ±.010)
CDR03	C1808	4.57 ±.38 (.180 ±.015)	2.03 ±.38 (.080 ±.015)	.56 (.022)	2.03 (.080)	.51 ± 0.25 (.020 ±.010)
CDR04	C1812	4.57 ±.38 (.180 ±.015)	3.18 ±.38 (.125 ±.015)	.56 (.022)	2.03 (.080)	.51 ± 0.25 (.020 ±.010)
CDR05	C1825	4.57 $\begin{pmatrix} +.51 & +.020 \\ & .180 \\ -.38 & -.015 \end{pmatrix}$	6.35 $\begin{pmatrix} +.51 & +.020 \\ & .250 \\ -.38 & -.015 \end{pmatrix}$	.51 (.020)	2.03 (.080)	.51 ± 0.25 (.020 ±.010)
CDR06	C2225	5.72 ±.51 (.225 ±.020)	6.35 ±.51 (.250 ±.020)	.51 (.020)	2.03 (.080)	.51 ± 0.25 (.020 ±.010)
CDR31	C0805	2.00 ±.20 (.078 ±.008)	1.25 ±.20 (.049 ±.008)		1.30 (.051)	.50 ± 0.20 (.020 ±.008)
CDR32	C1206	3.20 ±.20 (.125 ±.008)	1.60 ±.20 (.062 ±.008)		1.30 (.051)	.50 ± 0.20 (.020 ±.008)
CDR33	C1210	3.20 ±.25 (.125 ±.010)	2.50 ±.25 (.098 ±.010)		1.50 (.059)	.50 ± 0.25 (.020 ±.010)
CDR34	C1812	4.50 ±.25 (.176 ±.010)	3.20 ±.25 (.125 ±.010)		1.50 (.059)	.50 ± 0.25 (.020 ±.010)
CDR35	C1825	4.50 ±.30 (.176 ±.012)	6.40 ±.30 (.250 ±.012)		1.50 (.059)	.50 ± 0.30 (.020 ±.012)

Note: For Solderguard I (MIL-C55681 "S" or "U" Endmets), the length, width and thickness positive tolerances (including bandwidth) cited above are allowed to increase by the following amounts:

	Length	Width/Thickness
CDR01	0.51MM (.020)	0.38MM (.015)
CDR02-06	0.64MM (.025)	0.38MM (.015)
CDR31-35	0.60MM (.023)	0.30MM (.012)

## MIL-PRF-55681 PART NUMBER ORDERING INFORMATION

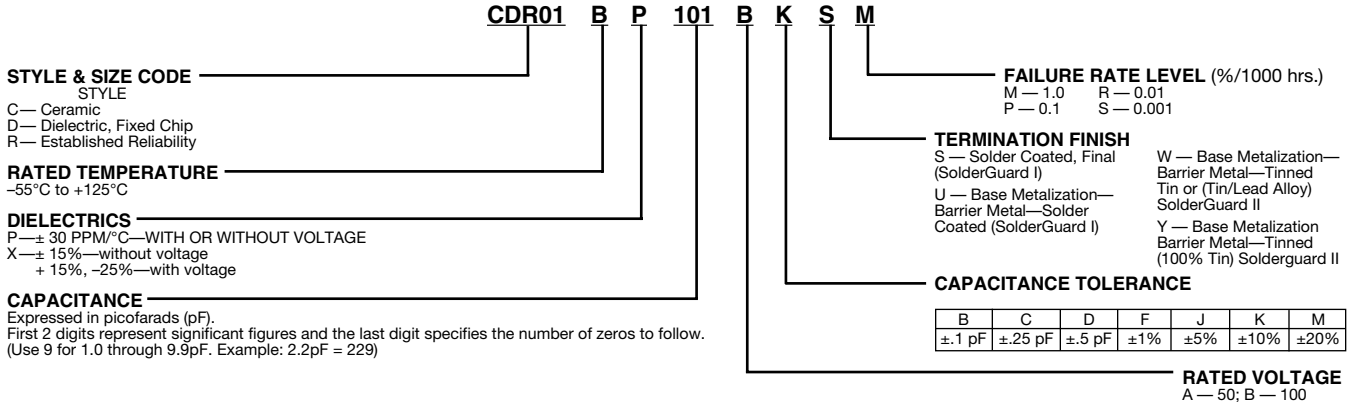

## KEMET/MIL-PRF-55681 PART NUMBER EQUIVALENTS

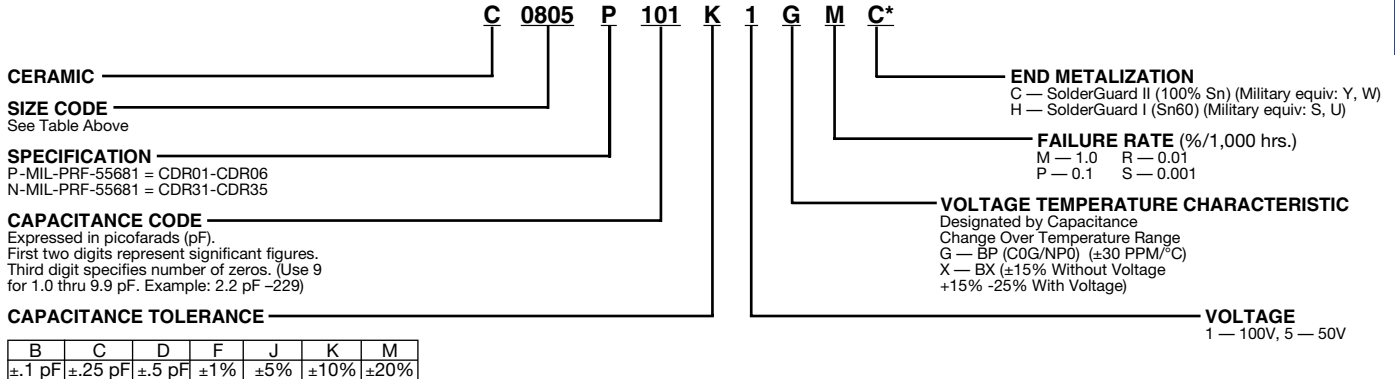

\* Part Number Example: C0805P101K1GMC (14 digits - no spaces)

## RATINGS & PART NUMBER REFERENCE

CHARAC-TERISTIC	CAP. pF	AVAIL. TOL.	KEMET CAPACITORS	MIL-PRF-55681 PART NUMBER
<b>100 Volt — C0805 SIZE (MILITARY CDR01)</b>				
BP	10	J,K	C0805P100(3)1G(4)C	CDR01BP100B(3)W(4)
	12	J	C0805P120J1G(4)C	CDR01BP120BJW(4)
	15	J,K	C0805P150(3)1G(4)C	CDR01BP150B(3)W(4)
	18	J	C0805P180J1G(4)C	CDR01BP180BJW(4)
	22	J,K	C0805P220(3)1G(4)C	CDR01BP220B(3)W(4)
	27	J	C0805P270J1G(4)C	CDR01BP270BJW(4)
	33	J,K	C0805P330(3)1G(4)C	CDR01BP330B(3)W(4)
	39	J	C0805P390J1G(4)C	CDR01BP390BJW(4)
	47	J,K	C0805P470(3)1G(4)C	CDR01BP470B(3)W(4)
	56	J	C0805P560J1G(4)C	CDR01BP560BJW(4)
	68	J,K	C0805P680(3)1G(4)C	CDR01BP680B(3)W(4)
	82	J	C0805P820J1G(4)C	CDR01BP820BJW(4)
	100	J,K	C0805P101(3)1G(4)C	CDR01BP101B(3)W(4)
	BP or BX	120	J,K	C0805P121(3)1(2)(4)C
150		J,K	C0805P151(3)1(2)(4)C	CDR01B(1)151B(3)W(4)
180		J,K	C0805P181(3)1(2)(4)C	CDR01B(1)181B(3)W(4)
BX	220	K,M	C0805P221(3)1X(4)C	CDR01BX221B(3)W(4)
	270	K	C0805P271K1X(4)C	CDR01BX271BKW(4)
	330	K,M	C0805P331(3)1X(4)C	CDR01BX331B(3)W(4)
	390	K	C0805P391K1X(4)C	CDR01BX391BKW(4)
	470	K,M	C0805P471(3)1X(4)C	CDR01BX471B(3)W(4)
	560	K	C0805P561K1X(4)C	CDR01BX561BKW(4)
	680	K,M	C0805P681(3)1X(4)C	CDR01BX681B(3)W(4)
	820	K	C0805P821K1X(4)C	CDR01BX821BKW(4)
	1,000	K,M	C0805P102(3)1X(4)C	CDR01BX102B(3)W(4)
	1,200	K	C0805P122K1X(4)C	CDR01BX122BKW(4)
	1,500	K,M	C0805P152(3)1X(4)C	CDR01BX152B(3)W(4)
	1,800	K	C0805P182K1X(4)C	CDR01BX182BKW(4)
	2,200	K,M	C0805P222(3)1X(4)C	CDR01BX222B(3)W(4)
	2,700	K	C0805P272K1X(4)C	CDR01BX272BKW(4)
3,300	K,M	C0805P332(3)1X(4)C	CDR01BX332B(3)W(4)	
<b>50 Volt — C0805 SIZE (MILITARY CDR01)</b>				
BX	3,900	K	C0805P392K5X(4)C	CDR01BX392AKW(4)
	4,700	K,M	C0805P472(3)5X(4)C	CDR01BX472A(3)W(4)
<b>100 Volt — C1805 SIZE (MILITARY CDR02)</b>				
BP	220	J,K	C1805P221(3)1G(4)C	CDR02BP221B(3)W(4)
	270	J	C1805P271J1G(4)C	CDR02BP271BJW(4)
BX	3,900	K	C1805P392K1X(4)C	CDR02BX392BKW(4)
	4,700	K,M	C1805P472(3)1X(4)C	CDR02BX472B(3)W(4)
	5,600	K	C1805P562K1X(4)C	CDR02BX562BKW(4)
	6,800	K,M	C1805P682(3)1X(4)C	CDR02BX682B(3)W(4)
	8,200	K	C1805P822K1X(4)C	CDR02BX822BKW(4)
	10,000	K,M	C1805P103(3)1X(4)C	CDR02BX103B(3)W(4)
	<b>50 Volt — C1805 SIZE (MILITARY CDR02)</b>			
BX	12,000	K	C1805P123K5X(4)C	CDR02BX123AKW(4)
	15,000	K,M	C1805P153(3)5X(4)C	CDR02BX153A(3)W(4)
	18,000	K	C1805P183K5X(4)C	CDR02BX183AKW(4)
	22,000	K,M	C1805P223(3)5X(4)C	CDR02BX223A(3)W(4)
<b>100 Volt — C1808 SIZE (MILITARY CDR03)</b>				
BP	330	J,K	C1808P331(3)1G(4)C	CDR03BP331B(3)W(4)
	390	J	C1808P391J1G(4)C	CDR03BP391BJW(4)
	470	J,K	C1808P471(3)1G(4)C	CDR03BP471B(3)W(4)

CHARAC-TERISTIC	CAP. pF	AVAIL. TOL.	KEMET CAPACITORS	MIL-PRF-55681 PART NUMBER
<b>100 Volt — C1808 SIZE (MILITARY CDR03) (Cont'd)</b>				
BP	560	J	C1808P561J1G(4)C	CDR03BP561BJW(4)
	680	J,K	C1808P681(3)1G(4)C	CDR03BP681B(3)W(4)
	820	J	C1808P821J1G(4)C	CDR03BP821BJW(4)
BX	1,000	J,K	C1808P102(3)1G(4)C	CDR03BP102B(3)W(4)
	12,000	K	C1808P123K1X(4)C	CDR03BX123BKW(4)
	15,000	K,M	C1808P153(3)1X(4)C	CDR03BX153B(3)W(4)
	18,000	K	C1808P183K1X(4)C	CDR03BX183BKW(4)
	22,000	K,M	C1808P223(3)1X(4)C	CDR03BX223B(3)W(4)
	27,000	K	C1808P273K1X(4)C	CDR03BX273BKW(4)
	33,000	K,M	C1808P333(3)1X(4)C	CDR03BX333B(3)W(4)
<b>50 Volt — C1808 SIZE (MILITARY CDR03)</b>				
BX	39,000	K	C1808P393K5X(4)C	CDR03BX393AKW(4)
	47,000	K,M	C1808P473(3)5X(4)C	CDR03BX473A(3)W(4)
	56,000	K	C1808P563K5X(4)C	CDR03BX563AKW(4)
68,000	K,M	C1808P683(3)5X(4)C	CDR03BX683A(3)W(4)	
<b>100 Volt — C1812 SIZE (MILITARY CDR04)</b>				
BP	1,200	J	C1812P122J1G(4)C	CDR04BP122BJW(4)
	1,500	J,K	C1812P152(3)1G(4)C	CDR04BP152B(3)W(4)
	1,800	J	C1812P182J1G(4)C	CDR04BP182BJW(4)
	2,200	J,K	C1812P222(3)1G(4)C	CDR04BP222B(3)W(4)
	2,700	J	C1812P272J1G(4)C	CDR04BP272BJW(4)
	3,300	J,K	C1812P332(3)1G(4)C	CDR04BP332B(3)W(4)
BX	39,000	K	C1812P393K1X(4)C	CDR04BX393BKW(4)
	47,000	K,M	C1812P473(3)1X(4)C	CDR04BX473B(3)W(4)
	56,000	K	C1812P563K1X(4)C	CDR04BX563BKW(4)
<b>50 Volt — C1812 SIZE (MILITARY CDR04)</b>				
BX	82,000	K	C1812P823K5X(4)C	CDR04BX823AKW(4)
	100,000	K,M	C1812P104(3)5X(4)C	CDR04BX104A(3)W(4)
	120,000	K	C1812P124K5X(4)C	CDR04BX124AKW(4)
	150,000	K,M	C1812P154(3)5X(4)C	CDR04BX154A(3)W(4)
	180,000	K	C1812P184K5X(4)C	CDR04BX184AKW(4)
<b>100 Volt — C1825 SIZE (MILITARY CDR05)</b>				
BP	3,900	J,K	C1825P392(3)1G(4)C	CDR05BP392B(3)W(4)
	4,700	J,K	C1825P472(3)1G(4)C	CDR05BP472B(3)W(4)
	5,600	J,K	C1825P562(3)1G(4)C	CDR05BP562B(3)W(4)
BX	68,000	K,M	C1825P683(3)1X(4)C	CDR05BX683B(3)W(4)
	82,000	K	C1825P823K1X(4)C	CDR05BX823BKW(4)
	100,000	K,M	C1825P104(3)1X(4)C	CDR05BX104B(3)W(4)
	120,000	K	C1825P124K1X(4)C	CDR05BX124BKW(4)
	150,000	K,M	C1825P154(3)1X(4)C	CDR05BX154B(3)W(4)
<b>50 Volt — C1825 SIZE (MILITARY CDR05)</b>				
BX	220,000	K,M	C1825P224(3)5X(4)C	CDR05BX224A(3)W(4)
	270,000	K	C1825P274K5X(4)C	CDR05BX274AKW(4)
	330,000	K,M	C1825P334(3)5X(4)C	CDR05BX334A(3)W(4)
<b>100 Volt — C2225 SIZE (MILITARY CDR06)</b>				
BP	6,800	J,K	C2225P682(3)1G(4)C	CDR06BP682B(3)W(4)
	8,200	J,K	C2225P822(3)1G(4)C	CDR06BP822B(3)W(4)
	10,000	J,K	C2225P103(3)1G(4)C	CDR06BP103B(3)W(4)
<b>50 Volt — C2225 SIZE (MILITARY CDR06)</b>				
BX	390,000	K	C2225P394K5X(4)C	CDR06BX394AKW(4)
	470,000	K,M	C2225P474(3)5X(4)C	CDR06BX474A(3)W(4)

- To complete Part Number for Dielectric, insert P or X symbol – as defined by Military specification.
- To complete Part Number for Dielectric, insert G or X symbol. (“G” for Military “BP,” or “X” for Military “BX.”)
- To complete Part Number, insert Capacitance Tolerance Symbol (when applicable) as available in MIL-PRF-55681: B – ±0.1 pF, C – ±0.25 pF, D – ±0.5pF, F – ±1%, J – ±5%, K – ±10%, M – ±20%. **NOTE: Available tolerances are listed in columns above.**
- To complete Part Number, insert Failure Rate Symbol: M –1.0%; P –0.1%; R –0.01%; S –.001%.

Note: All MIL-PRF-55681 and KEMET Part Numbers tabulated above assume use of Solderguard II (MIL-PRF-55681 “W”; KEMET “C”) end metalization. If MIL-PRF-55681 “U” or “S” (KEMET “H”) or MIL-PRF-55681 “Y” (KEMET “C”) is required, please change designators accordingly.

## RATINGS & PART NUMBER REFERENCE

CAP. pF	AVAIL. TOL.	KEMET CAPACITORS	MIL-PRF-55681 PART NUMBER
<b>100 Volt — BP — C0805 SIZE (MILITARY CDR31)</b>			
1.0	B,C	C0805N109(3)1G(4)C	CDR31BP1R0B(3)W(4)
1.1	B,C	C0805N119(3)1G(4)C	CDR31BP1R1B(3)W(4)
1.2	B,C	C0805N129(3)1G(4)C	CDR31BP1R2B(3)W(4)
1.3	B,C	C0805N139(3)1G(4)C	CDR31BP1R3B(3)W(4)
1.5	B,C	C0805N159(3)1G(4)C	CDR31BP1R5B(3)W(4)
1.6	B,C	C0805N169(3)1G(4)C	CDR31BP1R6B(3)W(4)
1.8	B,C	C0805N189(3)1G(4)C	CDR31BP1R8B(3)W(4)
2.0	B,C	C0805N209(3)1G(4)C	CDR31BP2R0B(3)W(4)
2.2	B,C	C0805N229(3)1G(4)C	CDR31BP2R2B(3)W(4)
2.4	B,C	C0805N249(3)1G(4)C	CDR31BP2R4B(3)W(4)
2.7	B,C,D	C0805N279(3)1G(4)C	CDR31BP2R7B(3)W(4)
3.0	B,C,D	C0805N309(3)1G(4)C	CDR31BP3R0B(3)W(4)
3.3	B,C,D	C0805N339(3)1G(4)C	CDR31BP3R3B(3)W(4)
3.6	B,C,D	C0805N369(3)1G(4)C	CDR31BP3R6B(3)W(4)
3.9	B,C,D	C0805N399(3)1G(4)C	CDR31BP3R9B(3)W(4)
4.3	B,C,D	C0805N439(3)1G(4)C	CDR31BP4R3B(3)W(4)
4.7	B,C,D	C0805N479(3)1G(4)C	CDR31BP4R7B(3)W(4)
5.1	B,C,D	C0805N519(3)1G(4)C	CDR31BP5R1B(3)W(4)
5.6	B,C,D	C0805N569(3)1G(4)C	CDR31BP5R6B(3)W(4)
6.2	B,C,D	C0805N629(3)1G(4)C	CDR31BP6R2B(3)W(4)
6.8	B,C,D	C0805N689(3)1G(4)C	CDR31BP6R8B(3)W(4)
7.5	B,C,D	C0805N759(3)1G(4)C	CDR31BP7R5B(3)W(4)
8.2	B,C,D	C0805N829(3)1G(4)C	CDR31BP8R2B(3)W(4)
9.1	B,C,D	C0805N919(3)1G(4)C	CDR31BP9R1B(3)W(4)
10	F,J,K	C0805N100(3)1G(4)C	CDR31BP100B(3)W(4)
11	F,J,K	C0805N110(3)1G(4)C	CDR31BP110B(3)W(4)
12	F,J,K	C0805N120(3)1G(4)C	CDR31BP120B(3)W(4)
13	F,J,K	C0805N130(3)1G(4)C	CDR31BP130B(3)W(4)
15	F,J,K	C0805N150(3)1G(4)C	CDR31BP150B(3)W(4)
16	F,J,K	C0805N160(3)1G(4)C	CDR31BP160B(3)W(4)
18	F,J,K	C0805N180(3)1G(4)C	CDR31BP180B(3)W(4)
20	F,J,K	C0805N200(3)1G(4)C	CDR31BP200B(3)W(4)
22	F,J,K	C0805N220(3)1G(4)C	CDR31BP220B(3)W(4)
24	F,J,K	C0805N240(3)1G(4)C	CDR31BP240B(3)W(4)
27	F,J,K	C0805N270(3)1G(4)C	CDR31BP270B(3)W(4)
30	F,J,K	C0805N300(3)1G(4)C	CDR31BP300B(3)W(4)
33	F,J,K	C0805N330(3)1G(4)C	CDR31BP330B(3)W(4)
36	F,J,K	C0805N360(3)1G(4)C	CDR31BP360B(3)W(4)
39	F,J,K	C0805N390(3)1G(4)C	CDR31BP390B(3)W(4)
43	F,J,K	C0805N430(3)1G(4)C	CDR31BP430B(3)W(4)
47	F,J,K	C0805N470(3)1G(4)C	CDR31BP470B(3)W(4)
51	F,J,K	C0805N510(3)1G(4)C	CDR31BP510B(3)W(4)
56	F,J,K	C0805N560(3)1G(4)C	CDR31BP560B(3)W(4)
62	F,J,K	C0805N620(3)1G(4)C	CDR31BP620B(3)W(4)
68	F,J,K	C0805N680(3)1G(4)C	CDR31BP680B(3)W(4)
75	F,J,K	C0805N750(3)1G(4)C	CDR31BP750B(3)W(4)
82	F,J,K	C0805N820(3)1G(4)C	CDR31BP820B(3)W(4)

CAP. pF	AVAIL. TOL.	KEMET CAPACITORS	MIL-PRF-55681 PART NUMBER
<b>100 Volt — BP — C0805 SIZE (MILITARY CDR31)</b>			
91	F,J,K	C0805N910(3)1G(4)C	CDR31BP910B(3)W(4)
100	F,J,K	C0805N101(3)1G(4)C	CDR31BP101B(3)W(4)
110	F,J,K	C0805N111(3)1G(4)C	CDR31BP111B(3)W(4)
120	F,J,K	C0805N121(3)1G(4)C	CDR31BP121B(3)W(4)
130	F,J,K	C0805N131(3)1G(4)C	CDR31BP131B(3)W(4)
150	F,J,K	C0805N151(3)1G(4)C	CDR31BP151B(3)W(4)
160	F,J,K	C0805N161(3)1G(4)C	CDR31BP161B(3)W(4)
180	F,J,K	C0805N181(3)1G(4)C	CDR31BP181B(3)W(4)
200	F,J,K	C0805N201(3)1G(4)C	CDR31BP201B(3)W(4)
220	F,J,K	C0805N221(3)1G(4)C	CDR31BP221B(3)W(4)
240	F,J,K	C0805N241(3)1G(4)C	CDR31BP241B(3)W(4)
270	F,J,K	C0805N271(3)1G(4)C	CDR31BP271B(3)W(4)
300	F,J,K	C0805N301(3)1G(4)C	CDR31BP301B(3)W(4)
330	F,J,K	C0805N331(3)1G(4)C	CDR31BP331B(3)W(4)
360	F,J,K	C0805N361(3)1G(4)C	CDR31BP361B(3)W(4)
390	F,J,K	C0805N391(3)1G(4)C	CDR31BP391B(3)W(4)
430	F,J,K	C0805N431(3)1G(4)C	CDR31BP431B(3)W(4)
470	F,J,K	C0805N471(3)1G(4)C	CDR31BP471B(3)W(4)
<b>50 Volt — BP — C0805 SIZE (MILITARY CDR31)</b>			
510	F,J,K	C0805N511(3)5G(4)C	CDR31BP511A(3)W(4)
560	F,J,K	C0805N561(3)5G(4)C	CDR31BP561A(3)W(4)
620	F,J,K	C0805N621(3)5G(4)C	CDR31BP621A(3)W(4)
680	F,J,K	C0805N681(3)5G(4)C	CDR31BP681A(3)W(4)
<b>100 Volt — BX — C0805 SIZE (MILITARY CDR31)</b>			
470	K,M	C0805N471(3)1X(4)C	CDR31BX471B(3)W(4)
560	K,M	C0805N561(3)1X(4)C	CDR31BX561B(3)W(4)
680	K,M	C0805N681(3)1X(4)C	CDR31BX681B(3)W(4)
820	K,M	C0805N821(3)1X(4)C	CDR31BX821B(3)W(4)
1,000	K,M	C0805N102(3)1X(4)C	CDR31BX102B(3)W(4)
1,200	K,M	C0805N122(3)1X(4)C	CDR31BX122B(3)W(4)
1,500	K,M	C0805N152(3)1X(4)C	CDR31BX152B(3)W(4)
1,800	K,M	C0805N182(3)1X(4)C	CDR31BX182B(3)W(4)
2,200	K,M	C0805N222(3)1X(4)C	CDR31BX222B(3)W(4)
2,700	K,M	C0805N272(3)1X(4)C	CDR31BX272B(3)W(4)
3,300	K,M	C0805N332(3)1X(4)C	CDR31BX332B(3)W(4)
3,900	K,M	C0805N392(3)1X(4)C	CDR31BX392B(3)W(4)
4,700	K,M	C0805N472(3)1X(4)C	CDR31BX472B(3)W(4)
<b>50 Volt — BX — C0805 SIZE (MILITARY CDR31)</b>			
5,600	K,M	C0805N562(3)5X(4)C	CDR31BX562A(3)W(4)
6,800	K,M	C0805N682(3)5X(4)C	CDR31BX682A(3)W(4)
8,200	K,M	C0805N822(3)5X(4)C	CDR31BX822A(3)W(4)
10,000	K,M	C0805N103(3)5X(4)C	CDR31BX103A(3)W(4)
12,000	K,M	C0805N123(3)5X(4)C	CDR31BX123A(3)W(4)
15,000	K,M	C0805N153(3)5X(4)C	CDR31BX153A(3)W(4)
18,000	K,M	C0805N183(3)5X(4)C	CDR31BX183A(3)W(4)

- (1) To complete Part Number for Dielectric, insert P or X symbol – as defined by Military specification.
- (2) To complete Part Number for Dielectric, insert G or X symbol. (“G” for Military “BP,” or “X” for Military “BX.”)
- (3) To complete Part Number, insert Capacitance Tolerance Symbol (when applicable) as available in MIL-PRF-55681: B – ±0.1 pF, C – ±0.25 pF, D – ±0.5pF, F – ±1%, J – ±5%, K – ±10%, M – ±20%. **NOTE: Available tolerances are listed in columns above.**
- (4) To complete Part Number, insert Failure Rate Symbol: M – 1.0%; P – 0.1%; R – 0.01%; S – .001%.

Note: All MIL-PRF-55681 and KEMET Part Numbers tabulated above assume use of Solderguard II (MIL-PRF-55681 “W”; KEMET “C”) end metal-ization. If MIL-PRF-55681 “U” or “S” (KEMET “H”) or MIL-PRF-55681 “Y” (KEMET “C”) is required, please change designators accordingly.

### MARKING

See page 97 for MIL-PRF-55681 Marking

Ceramic Surface Mount

## RATINGS & PART NUMBER REFERENCE

CAP. pF	AVAIL. TOL.	KEMET CAPACITORS	MIL-PRF-55681 PART NUMBER
<b>100 Volt — BP — C1206 SIZE (MILITARY CDR32)</b>			
1.0	B,C	C1206N109(3)1G(4)C	CDR32BP1R0B(3)W(4)
1.1	B,C	C1206N119(3)1G(4)C	CDR32BP1R1B(3)W(4)
1.2	B,C	C1206N129(3)1G(4)C	CDR32BP1R2B(3)W(4)
1.3	B,C	C1206N139(3)1G(4)C	CDR32BP1R3B(3)W(4)
1.5	B,C	C1206N159(3)1G(4)C	CDR32BP1R5B(3)W(4)
1.6	B,C	C1206N169(3)1G(4)C	CDR32BP1R6B(3)W(4)
1.8	B,C	C1206N189(3)1G(4)C	CDR32BP1R8B(3)W(4)
2.0	B,C	C1206N209(3)1G(4)C	CDR32BP2R0B(3)W(4)
2.2	B,C	C1206N229(3)1G(4)C	CDR32BP2R2B(3)W(4)
2.4	B,C	C1206N249(3)1G(4)C	CDR32BP2R4B(3)W(4)
2.7	B,C,D	C1206N279(3)1G(4)C	CDR32BP2R7B(3)W(4)
3.0	B,C,D	C1206N309(3)1G(4)C	CDR32BP3R0B(3)W(4)
3.3	B,C,D	C1206N339(3)1G(4)C	CDR32BP3R3B(3)W(4)
3.6	B,C,D	C1206N369(3)1G(4)C	CDR32BP3R6B(3)W(4)
3.9	B,C,D	C1206N399(3)1G(4)C	CDR32BP3R9B(3)W(4)
4.3	B,C,D	C1206N439(3)1G(4)C	CDR32BP4R3B(3)W(4)
4.7	B,C,D	C1206N479(3)1G(4)C	CDR32BP4R7B(3)W(4)
5.1	B,C,D	C1206N519(3)1G(4)C	CDR32BP5R1B(3)W(4)
5.6	B,C,D	C1206N569(3)1G(4)C	CDR32BP5R6B(3)W(4)
6.2	B,C,D	C1206N629(3)1G(4)C	CDR32BP6R2B(3)W(4)
6.8	B,C,D	C1206N689(3)1G(4)C	CDR32BP6R8B(3)W(4)
7.5	B,C,D	C1206N759(3)1G(4)C	CDR32BP7R5B(3)W(4)
8.2	B,C,D	C1206N829(3)1G(4)C	CDR32BP8R2B(3)W(4)
9.1	B,C,D	C1206N919(3)1G(4)C	CDR32BP9R1B(3)W(4)
10	F,J,K	C1206N100(3)1G(4)C	CDR32BP100B(3)W(4)
11	F,J,K	C1206N110(3)1G(4)C	CDR32BP110B(3)W(4)
12	F,J,K	C1206N120(3)1G(4)C	CDR32BP120B(3)W(4)
13	F,J,K	C1206N130(3)1G(4)C	CDR32BP130B(3)W(4)
15	F,J,K	C1206N150(3)1G(4)C	CDR32BP150B(3)W(4)
16	F,J,K	C1206N160(3)1G(4)C	CDR32BP160B(3)W(4)
18	F,J,K	C1206N180(3)1G(4)C	CDR32BP180B(3)W(4)
20	F,J,K	C1206N200(3)1G(4)C	CDR32BP200B(3)W(4)
22	F,J,K	C1206N220(3)1G(4)C	CDR32BP220B(3)W(4)
24	F,J,K	C1206N240(3)1G(4)C	CDR32BP240B(3)W(4)
27	F,J,K	C1206N270(3)1G(4)C	CDR32BP270B(3)W(4)
30	F,J,K	C1206N300(3)1G(4)C	CDR32BP300B(3)W(4)
33	F,J,K	C1206N330(3)1G(4)C	CDR32BP330B(3)W(4)
36	F,J,K	C1206N360(3)1G(4)C	CDR32BP360B(3)W(4)
39	F,J,K	C1206N390(3)1G(4)C	CDR32BP390B(3)W(4)
43	F,J,K	C1206N430(3)1G(4)C	CDR32BP430B(3)W(4)
47	F,J,K	C1206N470(3)1G(4)C	CDR32BP470B(3)W(4)
51	F,J,K	C1206N510(3)1G(4)C	CDR32BP510B(3)W(4)
56	F,J,K	C1206N560(3)1G(4)C	CDR32BP560B(3)W(4)
62	F,J,K	C1206N620(3)1G(4)C	CDR32BP620B(3)W(4)
68	F,J,K	C1206N680(3)1G(4)C	CDR32BP680B(3)W(4)
75	F,J,K	C1206N750(3)1G(4)C	CDR32BP750B(3)W(4)
82	F,J,K	C1206N820(3)1G(4)C	CDR32BP820B(3)W(4)
91	F,J,K	C1206N910(3)1G(4)C	CDR32BP910B(3)W(4)
100	F,J,K	C1206N101(3)1G(4)C	CDR32BP101B(3)W(4)

CAP. pF	AVAIL. TOL.	KEMET CAPACITORS	MIL-PRF-55681 PART NUMBER
<b>100 Volt — BP — C1206 SIZE (MILITARY CDR32)</b>			
110	F,J,K	C1206N111(3)1G(4)C	CDR32BP111B(3)W(4)
120	F,J,K	C1206N121(3)1G(4)C	CDR32BP121B(3)W(4)
130	F,J,K	C1206N131(3)1G(4)C	CDR32BP131B(3)W(4)
150	F,J,K	C1206N151(3)1G(4)C	CDR32BP151B(3)W(4)
160	F,J,K	C1206N161(3)1G(4)C	CDR32BP161B(3)W(4)
180	F,J,K	C1206N181(3)1G(4)C	CDR32BP181B(3)W(4)
200	F,J,K	C1206N201(3)1G(4)C	CDR32BP201B(3)W(4)
220	F,J,K	C1206N221(3)1G(4)C	CDR32BP221B(3)W(4)
240	F,J,K	C1206N241(3)1G(4)C	CDR32BP241B(3)W(4)
270	F,J,K	C1206N271(3)1G(4)C	CDR32BP271B(3)W(4)
300	F,J,K	C1206N301(3)1G(4)C	CDR32BP301B(3)W(4)
330	F,J,K	C1206N331(3)1G(4)C	CDR32BP331B(3)W(4)
360	F,J,K	C1206N361(3)1G(4)C	CDR32BP361B(3)W(4)
390	F,J,K	C1206N391(3)1G(4)C	CDR32BP391B(3)W(4)
430	F,J,K	C1206N431(3)1G(4)C	CDR32BP431B(3)W(4)
470	F,J,K	C1206N471(3)1G(4)C	CDR32BP471B(3)W(4)
510	F,J,K	C1206N511(3)1G(4)C	CDR32BP511B(3)W(4)
560	F,J,K	C1206N561(3)1G(4)C	CDR32BP561B(3)W(4)
620	F,J,K	C1206N621(3)1G(4)C	CDR32BP621B(3)W(4)
680	F,J,K	C1206N681(3)1G(4)C	CDR32BP681B(3)W(4)
750	F,J,K	C1206N751(3)1G(4)C	CDR32BP751B(3)W(4)
820	F,J,K	C1206N821(3)1G(4)C	CDR32BP821B(3)W(4)
910	F,J,K	C1206N911(3)1G(4)C	CDR32BP911B(3)W(4)
1,000	F,J,K	C1206N102(3)1G(4)C	CDR32BP102B(3)W(4)
<b>50 Volt — BP — C1206 SIZE (MILITARY CDR32)</b>			
1,100	F,J,K	C1206N112(3)5G(4)C	CDR32BP112A(3)W(4)
1,200	F,J,K	C1206N122(3)5G(4)C	CDR32BP122A(3)W(4)
1,300	F,J,K	C1206N132(3)5G(4)C	CDR32BP132A(3)W(4)
1,500	F,J,K	C1206N152(3)5G(4)C	CDR32BP152A(3)W(4)
1,600	F,J,K	C1206N162(3)5G(4)C	CDR32BP162A(3)W(4)
1,800	F,J,K	C1206N182(3)5G(4)C	CDR32BP182A(3)W(4)
2,000	F,J,K	C1206N202(3)5G(4)C	CDR32BP202A(3)W(4)
2,200	F,J,K	C1206N222(3)5G(4)C	CDR32BP222A(3)W(4)
<b>100 Volt — BX — C1206 SIZE (MILITARY CDR32)</b>			
4,700	K,M	C1206N472(3)1X(4)C	CDR32BX472B(3)W(4)
5,600	K,M	C1206N562(3)1X(4)C	CDR32BX562B(3)W(4)
6,800	K,M	C1206N682(3)1X(4)C	CDR32BX682B(3)W(4)
8,200	K,M	C1206N822(3)1X(4)C	CDR32BX822B(3)W(4)
10,000	K,M	C1206N103(3)1X(4)C	CDR32BX103B(3)W(4)
12,000	K,M	C1206N123(3)1X(4)C	CDR32BX123B(3)W(4)
15,000	K,M	C1206N153(3)1X(4)C	CDR32BX153B(3)W(4)
<b>50 Volt — BX — C1206 SIZE (MILITARY CDR32)</b>			
18,000	K,M	C1206N183(3)5X(4)C	CDR32BX183A(3)W(4)
22,000	K,M	C1206N223(3)5X(4)C	CDR32BX223A(3)W(4)
27,000	K,M	C1206N273(3)5X(4)C	CDR32BX273A(3)W(4)
33,000	K,M	C1206N333(3)5X(4)C	CDR32BX333A(3)W(4)
39,000	K,M	C1206N393(3)5X(4)C	CDR32BX393A(3)W(4)

- To complete Part Number for Dielectric, insert P or X symbol – as defined by Military specification.
- To complete Part Number for Dielectric, insert G or X symbol. (“G” for Military “BP,” or “X” for Military “BX.”)
- To complete Part Number, insert Capacitance Tolerance Symbol (when applicable) as available in MIL-PRF-55681: B – ±0.1 pF, C – ±0.25 pF, D – ±0.5pF, F – ±1%, J – ±5%, K – ±10%, M – ±20%. **NOTE: Available tolerances are listed in columns above.**
- To complete Part Number, insert Failure Rate Symbol: M –1.0%; P –0.1%; R –0.01%; S –.001%.

Note: All MIL-PRF-55681 and KEMET Part Numbers tabulated above assume use of Solderguard II (MIL-PRF-55681 “W”; KEMET “C”) end metalization. If MIL-PRF-55681 “U” or “S” (KEMET “H”) or MIL-PRF-55681 “Y” (KEMET “C”) is required, please change designators accordingly.



## RATINGS & PART NUMBER REFERENCE

CAP. pF	AVAIL. TOL.	KEMET CAPACITORS	MIL-PRF-55681 PART NUMBER
<b>100 Volt — BP — C1210 SIZE (MILITARY CDR33)</b>			
1,000	F,J,K	C1210N102(3)1G(4)C	CDR33BP102B(3)W(4)
1,100	F,J,K	C1210N112(3)1G(4)C	CDR33BP112B(3)W(4)
1,200	F,J,K	C1210N122(3)1G(4)C	CDR33BP122B(3)W(4)
1,300	F,J,K	C1210N132(3)1G(4)C	CDR33BP132B(3)W(4)
1,500	F,J,K	C1210N152(3)1G(4)C	CDR33BP152B(3)W(4)
1,600	F,J,K	C1210N162(3)1G(4)C	CDR33BP162B(3)W(4)
1,800	F,J,K	C1210N182(3)1G(4)C	CDR33BP182B(3)W(4)
2,000	F,J,K	C1210N202(3)1G(4)C	CDR33BP202B(3)W(4)
2,200	F,J,K	C1210N222(3)1G(4)C	CDR33BP222B(3)W(4)
<b>50 Volt — BP — C1210 SIZE (MILITARY CDR33)</b>			
2,400	F,J,K	C1210N242(3)5G(4)C	CDR33BP242A(3)W(4)
2,700	F,J,K	C1210N272(3)5G(4)C	CDR33BP272A(3)W(4)
3,000	F,J,K	C1210N302(3)5G(4)C	CDR33BP302A(3)W(4)
3,300	F,J,K	C1210N332(3)5G(4)C	CDR33BP332A(3)W(4)
<b>100 Volt — BX — C1210 SIZE (MILITARY CDR33)</b>			
15,000	K,M	C1210N153(3)1X(4)C	CDR33BX153B(3)W(4)
18,000	K,M	C1210N183(3)1X(4)C	CDR33BX183B(3)W(4)
22,000	K,M	C1210N223(3)1X(4)C	CDR33BX223B(3)W(4)
27,000	K,M	C1210N273(3)1X(4)C	CDR33BX273B(3)W(4)
<b>50 Volt — BX — C1210 SIZE (MILITARY CDR33)</b>			
39,000	K,M	C1210N393(3)5X(4)C	CDR33BX393A(3)W(4)
47,000	K,M	C1210N473(3)5X(4)C	CDR33BX473A(3)W(4)
56,000	K,M	C1210N563(3)5X(4)C	CDR33BX563A(3)W(4)
68,000	K,M	C1210N683(3)5X(4)C	CDR33BX683A(3)W(4)
82,000	K,M	C1210N823(3)5X(4)C	CDR33BX823A(3)W(4)
100,000	K,M	C1210N104(3)5X(4)C	CDR33BX104A(3)W(4)
<b>100 Volt — BP — C1812 SIZE (MILITARY CDR34)</b>			
2,200	F,J,K	C1812N222(3)1G(4)C	CDR34BP222B(3)W(4)
2,400	F,J,K	C1812N242(3)1G(4)C	CDR34BP242B(3)W(4)
2,700	F,J,K	C1812N272(3)1G(4)C	CDR34BP272B(3)W(4)
3,000	F,J,K	C1812N302(3)1G(4)C	CDR34BP302B(3)W(4)
3,300	F,J,K	C1812N332(3)1G(4)C	CDR34BP332B(3)W(4)
3,600	F,J,K	C1812N362(3)1G(4)C	CDR34BP362B(3)W(4)
3,900	F,J,K	C1812N392(3)1G(4)C	CDR34BP392B(3)W(4)
4,300	F,J,K	C1812N432(3)1G(4)C	CDR34BP432B(3)W(4)
4,700	F,J,K	C1812N472(3)1G(4)C	CDR34BP472B(3)W(4)
<b>50 Volt — BP — C1812 SIZE (MILITARY CDR34)</b>			
5,100	F,J,K	C1812N512(3)5G(4)C	CDR34BP512A(3)W(4)
5,600	F,J,K	C1812N562(3)5G(4)C	CDR34BP562A(3)W(4)
6,200	F,J,K	C1812N622(3)5G(4)C	CDR34BP622A(3)W(4)
6,800	F,J,K	C1812N682(3)5G(4)C	CDR34BP682A(3)W(4)
7,500	F,J,K	C1812N752(3)5G(4)C	CDR34BP752A(3)W(4)
8,200	F,J,K	C1812N822(3)5G(4)C	CDR34BP822A(3)W(4)
9,100	F,J,K	C1812N912(3)5G(4)C	CDR34BP912A(3)W(4)
10,000	F,J,K	C1812N103(3)5G(4)C	CDR34BP103A(3)W(4)

CAP. pF	AVAIL. TOL.	KEMET CAPACITORS	MIL-PRF-55681 PART NUMBER
<b>100 Volt — BX — C1812 SIZE (MILITARY CDR34)</b>			
27,000	K,M	C1812N273(3)1X(4)C	CDR34BX273B(3)W(4)
33,000	K,M	C1812N333(3)1X(4)C	CDR34BX333B(3)W(4)
39,000	K,M	C1812N393(3)1X(4)C	CDR34BX393B(3)W(4)
47,000	K,M	C1812N473(3)1X(4)C	CDR34BX473B(3)W(4)
56,000	K,M	C1812N563(3)1X(4)C	CDR34BX563B(3)W(4)
<b>50 Volt — BX — C1812 SIZE (MILITARY CDR34)</b>			
100,000	K,M	C1812N104(3)5X(4)C	CDR34BX104A(3)W(4)
120,000	K,M	C1812N124(3)5X(4)C	CDR34BX124A(3)W(4)
150,000	K,M	C1812N154(3)5X(4)C	CDR34BX154A(3)W(4)
180,000	K,M	C1812N184(3)5X(4)C	CDR34BX184A(3)W(4)
<b>100 Volt — BP — C1825 SIZE (MILITARY CDR35)</b>			
4,700	F,J,K	C1825N472(3)1G(4)C	CDR35BP472B(3)W(4)
5,100	F,J,K	C1825N512(3)1G(4)C	CDR35BP512B(3)W(4)
5,600	F,J,K	C1825N562(3)1G(4)C	CDR35BP562B(3)W(4)
6,200	F,J,K	C1825N622(3)1G(4)C	CDR35BP622B(3)W(4)
6,800	F,J,K	C1825N682(3)1G(4)C	CDR35BP682B(3)W(4)
7,500	F,J,K	C1825N752(3)1G(4)C	CDR35BP752B(3)W(4)
8,200	F,J,K	C1825N822(3)1G(4)C	CDR35BP822B(3)W(4)
9,100	F,J,K	C1825N912(3)1G(4)C	CDR35BP912B(3)W(4)
10,000	F,J,K	C1825N103(3)1G(4)C	CDR35BP103B(3)W(4)
<b>50 Volt — BP — C1825 SIZE (MILITARY CDR35)</b>			
11,000	F,J,K	C1825N113(3)5G(4)C	CDR35BP113A(3)W(4)
12,000	F,J,K	C1825N123(3)5G(4)C	CDR35BP123A(3)W(4)
13,000	F,J,K	C1825N133(3)5G(4)C	CDR35BP133A(3)W(4)
15,000	F,J,K	C1825N153(3)5G(4)C	CDR35BP153A(3)W(4)
16,000	F,J,K	C1825N163(3)5G(4)C	CDR35BP163A(3)W(4)
18,000	F,J,K	C1825N183(3)5G(4)C	CDR35BP183A(3)W(4)
20,000	F,J,K	C1825N203(3)5G(4)C	CDR35BP203A(3)W(4)
22,000	F,J,K	C1825N223(3)5G(4)C	CDR35BP223A(3)W(4)
<b>100 Volt — BX — C1825 SIZE (MILITARY CDR35)</b>			
56,000	K,M	C1825N563(3)1X(4)C	CDR35BX563B(3)W(4)
68,000	K,M	C1825N683(3)1X(4)C	CDR35BX683B(3)W(4)
82,000	K,M	C1825N823(3)1X(4)C	CDR35BX823B(3)W(4)
100,000	K,M	C1825N104(3)1X(4)C	CDR35BX104B(3)W(4)
120,000	K,M	C1825N124(3)1X(4)C	CDR35BX124B(3)W(4)
150,000	K,M	C1825N154(3)1X(4)C	CDR35BX154B(3)W(4)
<b>50 Volt — BX — C1825 SIZE (MILITARY CDR35)</b>			
180,000	K,M	C1825N184(3)5X(4)C	CDR35BX184A(3)W(4)
220,000	K,M	C1825N224(3)5X(4)C	CDR35BX224A(3)W(4)
270,000	K,M	C1825N274(3)5X(4)C	CDR35BX274A(3)W(4)
330,000	K,M	C1825N334(3)5X(4)C	CDR35BX334A(3)W(4)
390,000	K,M	C1825N394(3)5X(4)C	CDR35BX394A(3)W(4)
470,000	K,M	C1825N474(3)5X(4)C	CDR35BX474A(3)W(4)

- (1) To complete Part Number for Dielectric, insert P or X symbol – as defined by Military specification.
- (2) To complete Part Number for Dielectric, insert G or X symbol. (“G” for Military “BP,” or “X” for Military “BX.”)
- (3) To complete Part Number, insert Capacitance Tolerance Symbol (when applicable) as available in MIL-PRF-55681: B – ±0.1 pF, C – ±0.25 pF, D – ±0.5pF, F – ±1%, J – ±5%, K – ±10%, M – ±20%. **NOTE: Available tolerances are listed in columns above.**
- (4) To complete Part Number, insert Failure Rate Symbol: M –1.0%; P –0.1%; R –0.01%; S –.001%.

Note: All MIL-PRF-55681 and KEMET Part Numbers tabulated above assume use of Solderguard II (MIL-PRF-55681 “W”; KEMET “C”) end metal-ization. If MIL-PRF-55681 “U” or “S” (KEMET “H”) or MIL-PRF-55681 “Y” (KEMET “C”) is required, please change designators accordingly.

## MIL-PRF-55681 MAXIMUM INDIVIDUAL PACKAGING QUANTITIES

CHIP SIZE	BULK -			CHIP SIZE	BULK -		
	REELED	STD BAG	ANTI-STATIC BAG		REELED	STD BAG	ANTI-STATIC BAG
C0805	2,500	25,000	10,000	C1808	2,500	7,500	3,000
C1206	2,500	25,000	10,000	C1812	1,100	7,500	3,000
C1210	2,500	25,000	10,000	C1825	1,100	7,500	1,000
C1805	2,500	7,500	3,000	C2225	1,100	5,000	1,000

MIL-PRF-55681 chips available in 7" reels only.

### Tape & Reel Packaging

KEMET offers Multilayer Ceramic Chip Capacitors packaged in 8mm and 12mm plastic tape on 7" and 13" reels in accordance with EIA standard 481-1: Taping of surface mount components for automatic handling. This packaging system is compatible with all tape fed automatic pick and place systems. See page 78 for details on reeling quantities for commercial chips and page 87 for MIL-PRF-55681 chips.

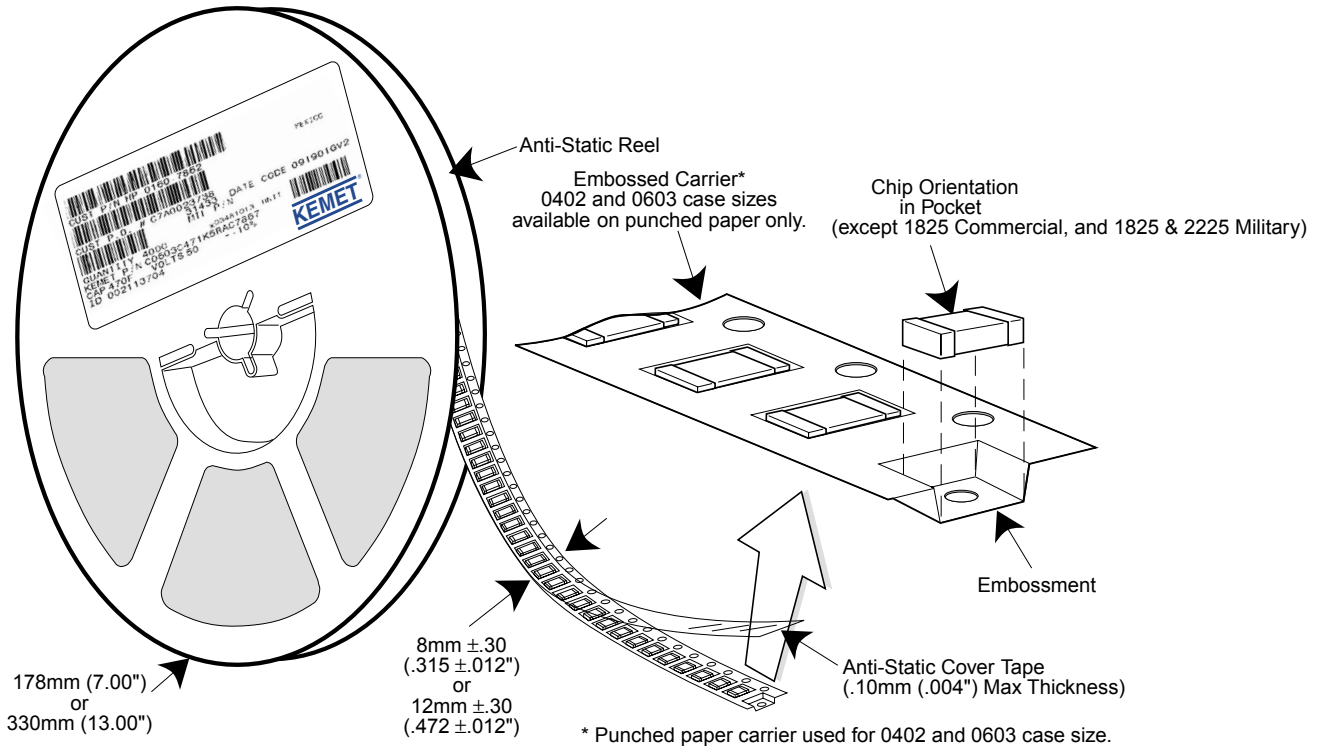

### SURFACE MOUNT LAND DIMENSIONS - CERAMIC CHIP CAPACITORS - MM

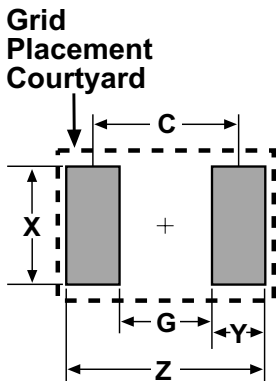

Dimension	Reflow Solder					Wave Solder				
	Z	G	X	Y(ref)	C(ref)	Z	G	X	Y(ref)	Smin
0402	2.14	0.28	0.74	0.93	1.21	Not Recommended				
0603	2.78	0.68	1.08	1.05	1.73	3.18	0.68	0.80	1.25	1.93
0805	3.30	0.70	1.60	1.30	2.00	3.70	0.70	1.10	1.50	2.20
1206	4.50	1.50	2.00	1.50	3.00	4.90	1.50	1.40	1.70	3.20
1210	4.50	1.50	2.90	1.50	3.00	4.90	1.50	2.00	1.70	3.20
1812	5.90	2.30	3.70	1.80	4.10	Not Recommended				
1825	5.90	2.30	6.90	1.80	4.10					
2220	7.00	3.30	5.50	1.85	5.15					
2225	7.00	3.30	6.80	1.85	5.15	Not Recommended				

Calculation Formula  
 $Z = Lmin + 2Jt + Tt$   
 $G = Smax - 2Jh - Th$   
 $X = Wmin + 2Js + Ts$   
 Tt, Th, Ts = Combined tolerances

# TANTALUM, CERAMIC AND ALUMINUM CHIP CAPACITORS

## Packaging Information

### Performance Notes

- Cover Tape Break Force:** 1.0 Kg Minimum.
- Cover Tape Peel Strength:** The total peel strength of the cover tape from the carrier tape shall be:

Tape Width	Peel Strength
8 mm	0.1 Newton to 1.0 Newton (10g to 100g)
12 mm	0.1 Newton to 1.3 Newton (10g to 130g)

The direction of the pull shall be opposite the direction of the carrier tape travel. The pull angle of the carrier tape shall be 165° to 180° from the plane of the carrier tape. During peeling, the carrier and/or cover tape shall be pulled at a velocity of 300 ±10 mm/minute.

- Reel Sizes:** Molded tantalum capacitors are available on either 180 mm (7") reels (standard) or 330 mm (13") reels (with C-7280). Note that 13" reels are preferred.
- Labeling:** Bar code labeling (standard or custom) shall be on the side of the reel opposite the sprocket holes. Refer to EIA-556.

### Embossed Carrier Tape Configuration: Figure 1

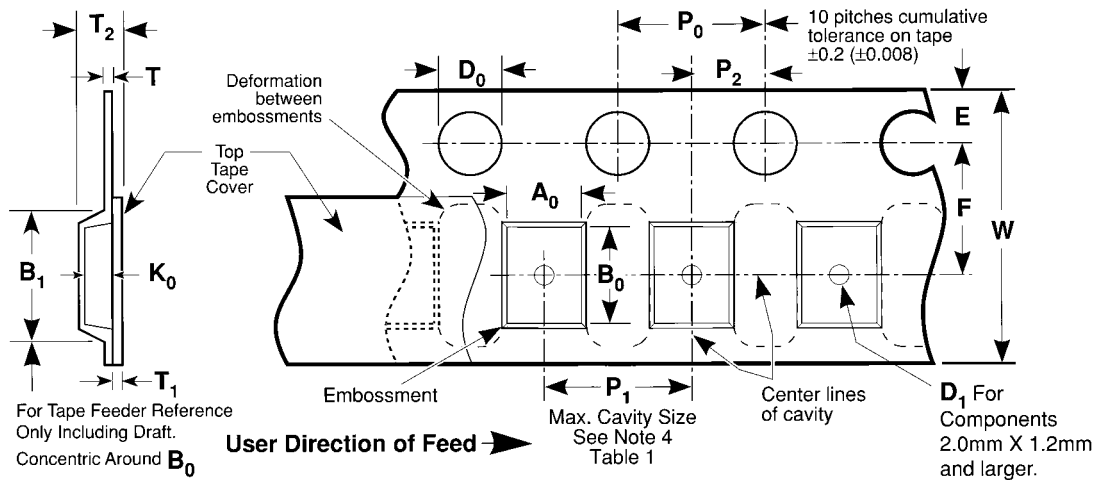

**Table 1 — EMBOSSED TAPE DIMENSIONS (Metric will govern)**

Constant Dimensions — Millimeters (Inches)									
Tape Size	D <sub>0</sub>	E	P <sub>0</sub>	P <sub>2</sub>	T Max	T <sub>1</sub> Max			
8 mm and 12 mm	1.5 +0.10 -0.0 (0.059 +0.004, -0.0)	1.75 ±0.10 (0.069 ±0.004)	4.0 ±0.10 (0.157 ±0.004)	2.0 ±0.05 (0.079 ±0.002)	0.600 (0.024)	0.100 (0.004)			
Variable Dimensions — Millimeters (Inches)									
Tape Size	Pitch	B <sub>1</sub> Max. Note 1	D <sub>1</sub> Min. Note 2	F	P <sub>1</sub>	R Min. Note 3	T <sub>2</sub> Max	W	A <sub>0</sub> B <sub>0</sub> K <sub>0</sub> Note 4
8 mm	Single (4 mm)	4.4 (0.173)	1.0 (0.039)	3.5 ±0.05 (0.138 ±0.002)	4.0 ±0.10 (0.157 ±0.004)	25.0 (0.984)	2.5 (0.098)	8.0 ±0.30 (.315 ±0.012)	
12 mm	Double (8 mm)	8.2 (0.323)	1.5 (0.059)	5.5 ±0.05 (0.217 ±0.002)	8.0 ±0.10 (0.315 ±0.004)	30.0 (1.181)	4.6 (0.181)	12.0 ±0.30 (0.472 ±0.012)	

### NOTES

- B<sub>1</sub> dimension is a reference dimension for tape feeder clearance only.
- The embossment hole location shall be measured from the sprocket hole controlling the location of the embossment. Dimensions of embossment location and hole location shall be applied independent of each other.
- Tape with components shall pass around radius "R" without damage (see sketch A). The minimum trailer length (Fig. 2) may require additional length to provide R min. for 12 mm embossed tape for reels with hub diameters approaching N min. (Table 2)
- The cavity defined by A<sub>0</sub>, B<sub>0</sub>, and K<sub>0</sub> shall be configured to surround the part with sufficient clearance such that the chip does not protrude beyond the sealing plane of the cover tape, the chip can be removed from the cavity in a vertical direction without mechanical restriction, rotation of the chip is limited to 20 degrees maximum in all 3 planes, and lateral movement of the chip is restricted to 0.5 mm maximum in the pocket (not applicable to vertical clearance.)

# TANTALUM, CERAMIC AND ALUMINUM CHIP CAPACITORS



## Packaging Information

### Embossed Carrier Tape Configuration (cont.)

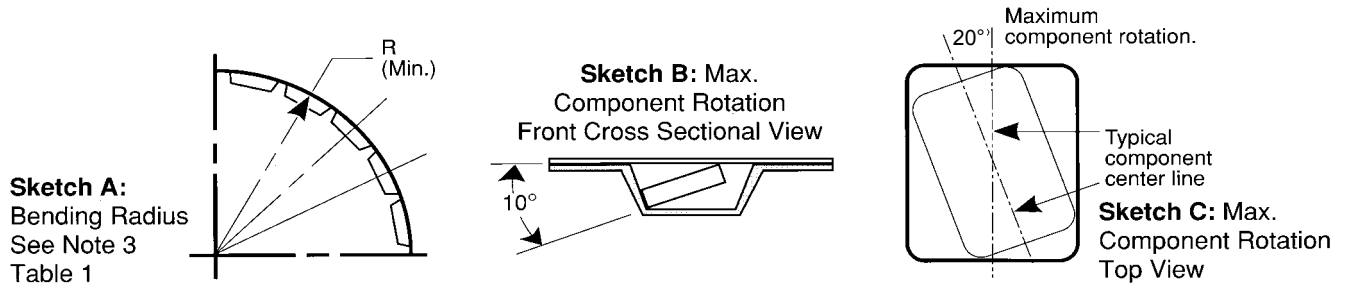

### Sketch D: Tape Camber (Top View)

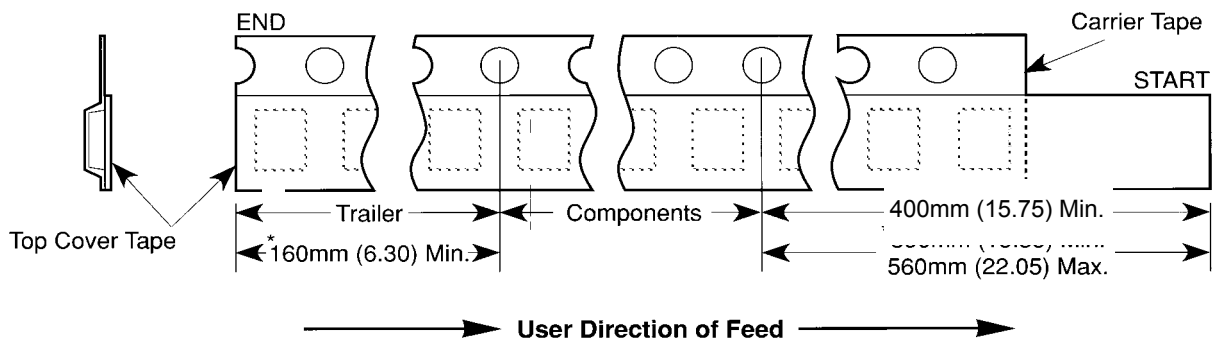
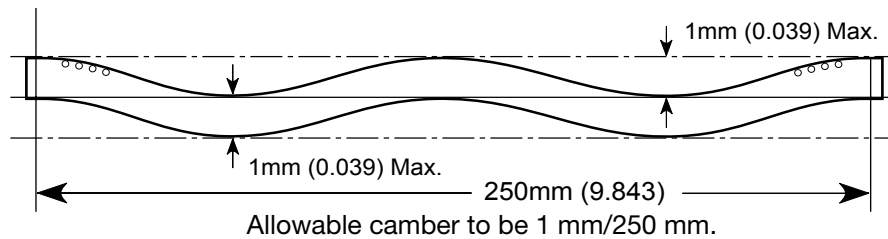

**Figure 2:** Tape Leader & Trailer Dimensions (Metric Dimensions Will Govern)

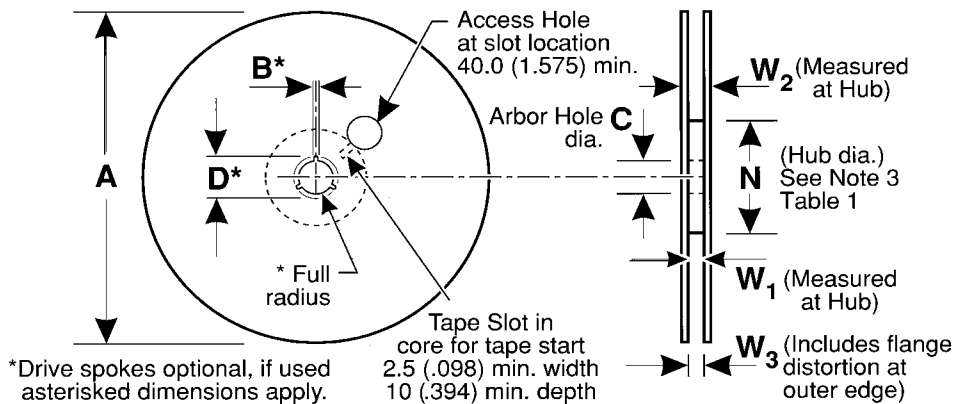

**Figure 3:** Reel Dimensions (Metric Dimensions will govern)

**Table 2 – REEL DIMENSIONS (Metric will govern)**

Tape Size	A Max	$B^*$ Min	C	$D^*$ Min	N Min	$W_1$	$W_2$ Max	$W_3$
8 mm	330.0 (12.992)	1.5 (0.059)	13.0 ± 0.20 (0.512 ± 0.008)	20.2 (0.795)	50.0 (1.969) See Note 3 Table 1	8.4 +1.5, -0.0 (0.331 +0.059, -0.0)	14.4 (0.567)	7.9 Min (0.311) 10.9 Max (0.429)
12 mm	330.0 (12.992)	1.5 (0.059)	13.0 ± 0.20 (0.512 ± 0.008)	20.2 (0.795)	Table 1	12.4 +2.0, -0.0 (0.488 +0.078, -0.0)	18.4 (0.724)	11.9 Min (0.469) 15.4 Max (0.606)



### Punched Carrier (Paper Tape) Configuration (Ceramic Chips Only):

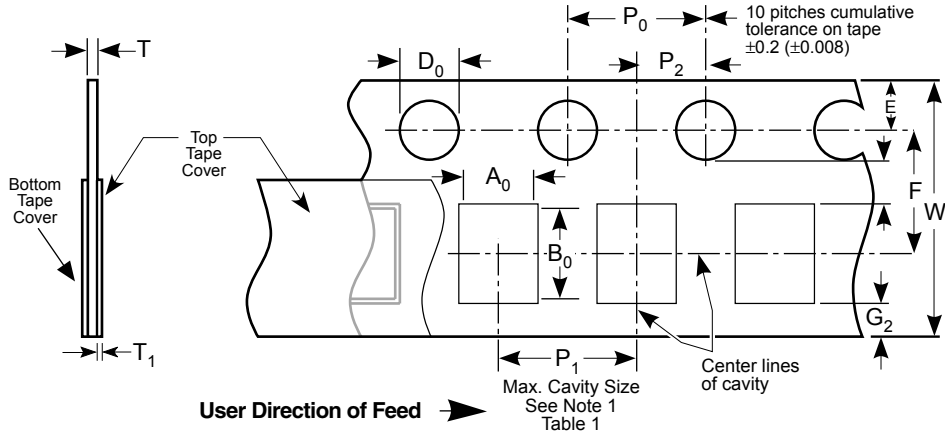

**Table 1: 8 & 12mm Punched Tape**  
(Metric Dimensions Will Govern)

**Constant Dimensions - Millimeters (Inches)**

Tape Size	D <sub>0</sub>	E	P <sub>0</sub>	P <sub>2</sub>	T <sub>1</sub>	G <sub>1</sub>	G <sub>2</sub>	R Min.
8mm and 12mm	1.5 +0.10, -0.0 (.059 +0.004, -0.0)	1.75 ±0.10 (.069 ±0.004)	4.0 ± 0.10 (.157 ± 0.004)	2.0 ± 0.05 (.079 ± 0.002)	0.10 (.004) Max.	0.75 (.030) Min.	0.75 (.030) Min.	25 (.984) See Note 2 Table 1

**Table 1: 8 & 12mm Punched Tape**  
(Metric Dimensions Will Govern)

**Variable Dimensions - Millimeters (Inches)**

Tape Size	P <sub>1</sub>	F	W	A <sub>0</sub> B <sub>0</sub>	T
8mm 1/2 Pitch	2.0 ± 0.10 (.079 ± .004) See Requirements Section 3.3 (d)	3.5 ± 0.05 (.138 ± .002)	8.0 ± 0.3 (.315 ± 0.012)	See Note 1 Table 1	1.1mm (.043) Max. for Paper Base Tape and 1.6mm (.063) Max. for Non- Paper Base Compositions. See Note 3.
8mm	4.0 ± 0.10 (0.157 ± .004)				
12mm	4.0 ± 0.10 (0.157 ± .004)	5.5 ± 0.05 (.217 ± .002)	12.0 ± 0.3 (.472 ± .012)		
12mm Double Pitch	8.0 ± 0.10 (0.315 ± .004)				

**Note:**

- A<sub>0</sub>, B<sub>0</sub> and T determined by the maximum dimensions to the ends of the terminals extending from the body and/or the body dimensions of the component. The clearance between the ends of the terminals or body of the component to the sides and depth of the cavity (A<sub>0</sub>, B<sub>0</sub> and T) must be within 0.05mm (.002) minimum and 0.50mm (.020) maximum. The clearance allowed must also prevent rotation of the component within the cavity of not more than 20 degrees (see sketches A and B).
- Tape with components shall pass around radius "R" without damage.
- KEMET nominal thicknesses are: 0402 = 0.6mm and all others 0.95mm minimum.

**Sketch A:**  
Bending Radius  
See Note 2  
Table 1

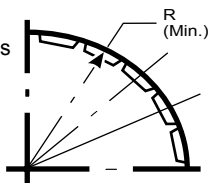

**Sketch B:**  
Max. Component  
Rotation - Front  
Cross Sectional View

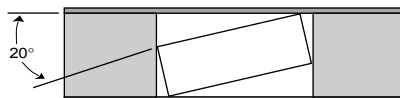

**Sketch C:**  
Component Rotation - Top View

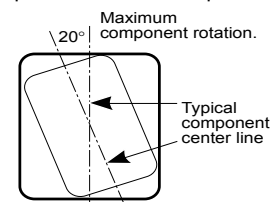

### Bulk Cassette Packaging (Ceramic Chips only) (Meets Dimensional Requirements IEC-286-6 and EIAJ 7201)

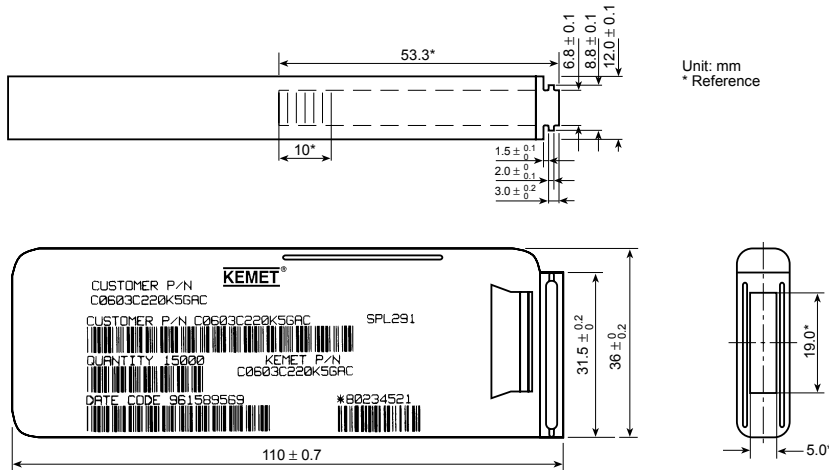

### Table 2 – Capacitance Values Available In Bulk Cassette Packaging

Case Size	Dielectric	Voltage	Min. Cap Value	Max. Cap Value
0402	All	All	All	All
0603	All	All	All	All
0805	C0G	200	109	181
		100	109	331
		50	109	102
	X7R	200	221	392
		100	221	103
		50	221	273
		25	221	104
		16	221	104
	Y5V	25	104	224
		16	104	224

### Table 1 – Capacitor Dimensions for Bulk Cassette Packaging – Millimeters

Metric Size Code	EIA Size Code	Length L	Width W	Thickness T	Bandwidth B	Minimum Separation S	Number of Pcs/Cassette
1005	0402	1.0 ± 0.05	0.5 ± 0.05	0.5 ± .05	0.2 to 0.4	0.3	50,000
1608	0603	1.6 ± 0.07	0.8 ± 0.07	0.8 ± .07	0.2 to 0.5	0.7	15,000
2012	0805	2.0 ± 0.10	1.25 ± 0.10	0.6 ± .10	0.5 to 0.75	0.75	10,000

Terminations: KEMET nickel barrier layer with a tin overplate.

### CAPACITOR MARKING TABLE (Marking Optional - Not Available for 0402 Size or Y5V Dielectric)

Alpha Character	Capacitance (pF) For Various Numeral Identifiers						
	9	0	1	2	3	4	5
A	0.10	1.0	10	100	1000	10,000	100,000
B	0.11	1.1	11	110	1100	11,000	110,000
C	0.12	1.2	12	120	1200	12,000	120,000
D	0.13	1.3	13	130	1300	13,000	130,000
E	0.15	1.5	15	150	1500	15,000	150,000
F	0.16	1.6	16	160	1600	16,000	160,000
G	0.18	1.8	18	180	1800	18,000	180,000
H	0.20	2.0	20	200	2000	20,000	200,000
J	0.22	2.2	22	220	2200	22,000	220,000
K	0.24	2.4	24	240	2400	24,000	240,000
L	0.27	2.7	27	270	2700	27,000	270,000
M	0.30	3.0	30	300	3000	30,000	300,000
N	0.33	3.3	33	330	3300	33,000	330,000
P	0.36	3.6	36	360	3600	36,000	360,000
Q	0.39	3.9	39	390	3900	39,000	390,000
R	0.43	4.3	43	430	4300	43,000	430,000
S	0.47	4.7	47	470	4700	47,000	470,000
T	0.51	5.1	51	510	5100	51,000	510,000
U	0.56	5.6	56	560	5600	56,000	560,000
V	0.62	6.2	62	620	6200	62,000	620,000
W	0.68	6.8	68	680	6800	68,000	680,000
X	0.75	7.5	75	750	7500	75,000	750,000
Y	0.82	8.2	82	820	8200	82,000	820,000
Z	0.91	9.1	91	910	9100	91,000	910,000
a	0.25	2.5	25	250	2500	25,000	250,000
b	0.35	3.5	35	350	3500	35,000	350,000
d	0.40	4.0	40	400	4000	40,000	400,000
e	0.45	4.5	45	450	4500	45,000	450,000
f	0.50	5.0	50	500	5000	50,000	500,000
m	0.60	6.0	60	600	6000	60,000	600,000
n	0.70	7.0	70	700	7000	70,000	700,000
t	0.80	8.0	80	800	8000	80,000	800,000
y	0.90	9.0	90	900	9000	90,000	900,000

Laser marking is available as an extra-cost option for most KEMET ceramic chips. Such marking is two sided, and includes a  $\bar{K}$  to identify KEMET, followed by two characters (per EIA-198 - see table below) to identify the capacitance value. Note that marking is not available for size 0402 nor for any Y5V chip. In addition, the 0603 marking option is limited to the  $\bar{K}$  only.



Example shown is 1,000 pF capacitor.