

# IRF1902UPbF

HEXFET® Power MOSFET

- Ultra Low On-Resistance
- N-Channel MOSFET
- Surface Mount
- Available in Tape & Reel
- Lead-Free

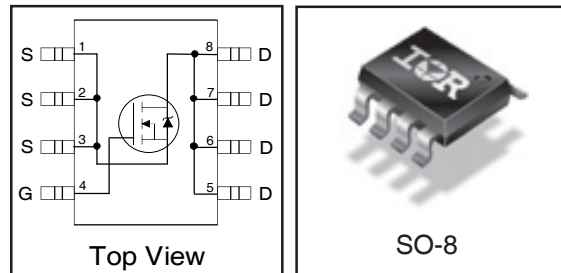
V <sub>DSS</sub>	R <sub>DS(on)</sub> max (mΩ)	I <sub>D</sub>
20V	85 @ V <sub>GS</sub> = 4.5V	4.0A
	170 @ V <sub>GS</sub> = 2.7V	3.2A

www.DataSheet4U.com

## Description

These N-Channel HEXFET® Power MOSFETs from International Rectifier utilize advanced processing techniques to achieve the extremely low on-resistance per silicon area. This benefit provides the designer with an extremely efficient device for use in battery and load management applications.

The SO-8 has been modified through a customized leadframe for enhanced thermal characteristics and multiple-die capability making it ideal in a variety of power applications. With these improvements, multiple devices can be used in an application with dramatically reduced board space. The package is designed for vapor phase, infrared, or wave soldering techniques.



## Absolute Maximum Ratings

	Parameter	Max.	Units
V <sub>DS</sub>	Drain- Source Voltage	20	V
I <sub>D</sub> @ T <sub>A</sub> = 25°C	Continuous Drain Current, V <sub>GS</sub> @ 4.5V	4.2	A
I <sub>D</sub> @ T <sub>A</sub> = 70°C	Continuous Drain Current, V <sub>GS</sub> @ 4.5V	3.4	
I <sub>DM</sub>	Pulsed Drain Current ①	17	
P <sub>D</sub> @ T <sub>A</sub> = 25°C	Power Dissipation ③	2.5	W
P <sub>D</sub> @ T <sub>A</sub> = 70°C	Power Dissipation ③	1.6	
	Linear Derating Factor	0.02	mW/°C
V <sub>GS</sub>	Gate-to-Source Voltage	± 12	V
T <sub>J</sub> , T <sub>STG</sub>	Junction and Storage Temperature Range	-55 to + 150	°C

## Thermal Resistance

Symbol	Parameter	Typ.	Max.	Units
R <sub>θJL</sub>	Junction-to-Drain Lead	—	20	°C/W
R <sub>θJA</sub>	Junction-to-Ambient ③	—	50	

www.irf.com

1

09/18/06

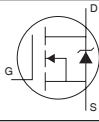
# IRF1902UPbF

International  
IR Rectifier

## Electrical Characteristics @ $T_J = 25^\circ\text{C}$ (unless otherwise specified)

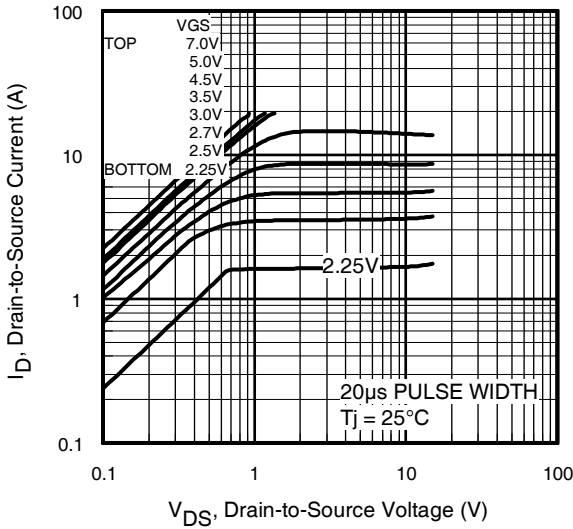
	Parameter	Min.	Typ.	Max.	Units	Conditions
$V_{(BR)DSS}$	Drain-to-Source Breakdown Voltage	20	—	—	V	$V_{GS} = 0V, I_D = 250\mu A$
$\Delta V_{(BR)DSS}/\Delta T_J$	Breakdown Voltage Temp. Coefficient	—	0.019	—	V/ $^\circ\text{C}$	Reference to $25^\circ\text{C}, I_D = 1\text{mA}$
$R_{DS(on)}$	Static Drain-to-Source On-Resistance	—	—	85	m $\Omega$	$V_{GS} = 4.5V, I_D = 4.0A$ ②
		—	—	170		$V_{GS} = 2.7V, I_D = 3.2A$ ②
$V_{GS(th)}$	Gate Threshold Voltage	0.70	—	—	V	$V_{DS} = V_{GS}, I_D = 250\mu A$
$g_{fs}$	Forward Transconductance	5.6	—	—	S	$V_{DS} = 10V, I_D = 4.0A$
$I_{DSS}$	Drain-to-Source Leakage Current	—	—	1.0	$\mu A$	$V_{DS} = 16V, V_{GS} = 0V$
		—	—	25		$V_{DS} = 16V, V_{GS} = 0V, T_J = 70^\circ\text{C}$
$I_{GSS}$	Gate-to-Source Forward Leakage	—	—	100	nA	$V_{GS} = 12V$
	Gate-to-Source Reverse Leakage	—	—	-100		$V_{GS} = -12V$
$Q_g$	Total Gate Charge	—	5.0	7.5	nC	$I_D = 4.2A$
$Q_{gs}$	Gate-to-Source Charge	—	1.2	—		$V_{DS} = 10V$
$Q_{gd}$	Gate-to-Drain ("Miller") Charge	—	1.8	—		$V_{GS} = 4.5V$
$t_{d(on)}$	Turn-On Delay Time	—	5.9	—	ns	$V_{DD} = 10V$ ②
$t_r$	Rise Time	—	13	—		$I_D = 1.0A$
$t_{d(off)}$	Turn-Off Delay Time	—	23	—		$R_G = 53\Omega$
$t_f$	Fall Time	—	19	—		$V_{GS} = 4.5V$
$C_{iss}$	Input Capacitance	—	310	—	pF	$V_{GS} = 0V$
$C_{oss}$	Output Capacitance	—	130	—		$V_{DS} = 15V$
$C_{riss}$	Reverse Transfer Capacitance	—	55	—		$f = 1.0\text{MHz}$

## Source-Drain Ratings and Characteristics

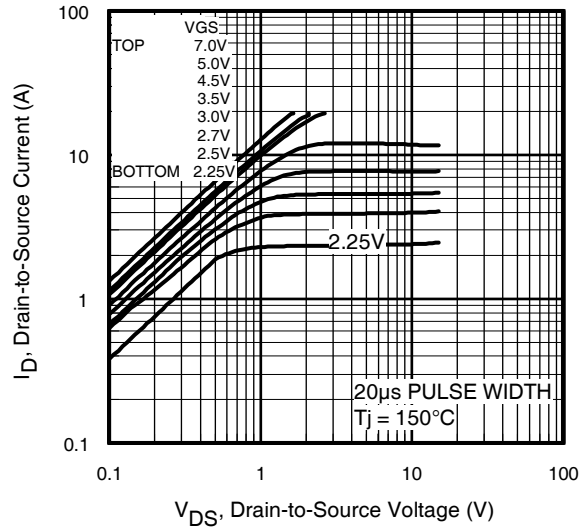
	Parameter	Min.	Typ.	Max.	Units	Conditions
$I_S$	Continuous Source Current (Body Diode)	—	—	4.2	A	MOSFET symbol showing the integral reverse p-n junction diode. 
$I_{SM}$	Pulsed Source Current (Body Diode) ①	—	—	17		
$V_{SD}$	Diode Forward Voltage	—	—	1.2	V	$T_J = 25^\circ\text{C}, I_S = 2.5A, V_{GS} = 0V$ ②
$t_{rr}$	Reverse Recovery Time	—	38	57	ns	$T_J = 25^\circ\text{C}, I_F = 2.5A$
$Q_{rr}$	Reverse Recovery Charge	—	42	63	nC	$di/dt = 100A/\mu s$ ②

### Notes:

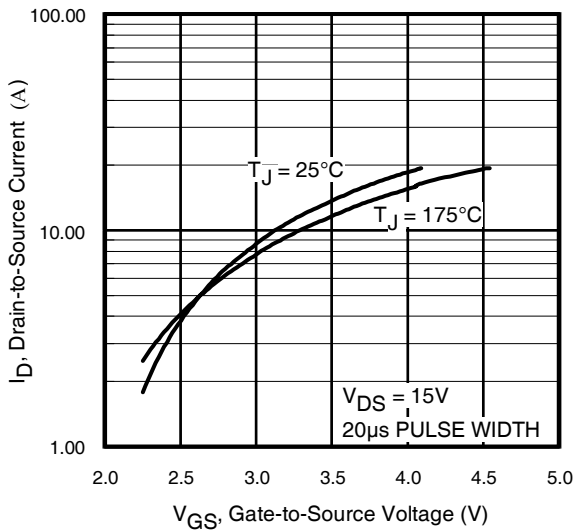
- ① Repetitive rating; pulse width limited by max. junction temperature.
- ② Pulse width  $\leq 400\mu s$ ; duty cycle  $\leq 2\%$ .
- ③ Surface mounted on 1 in square Cu board



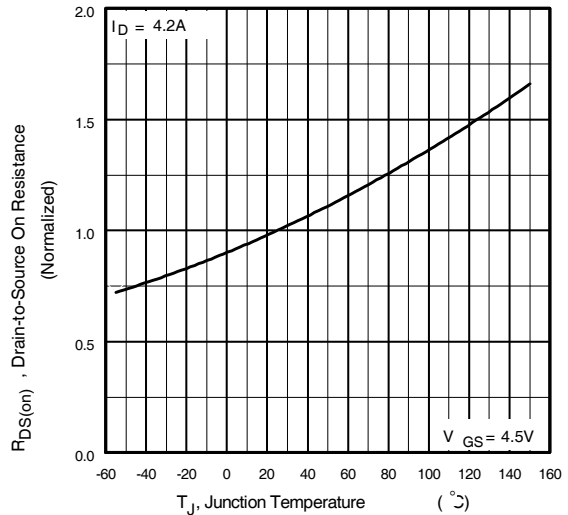
**Fig 1.** Typical Output Characteristics



**Fig 2.** Typical Output Characteristics

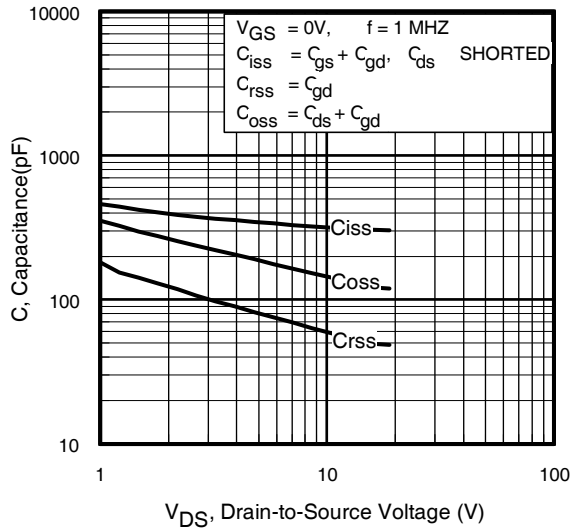


**Fig 3.** Typical Transfer Characteristics

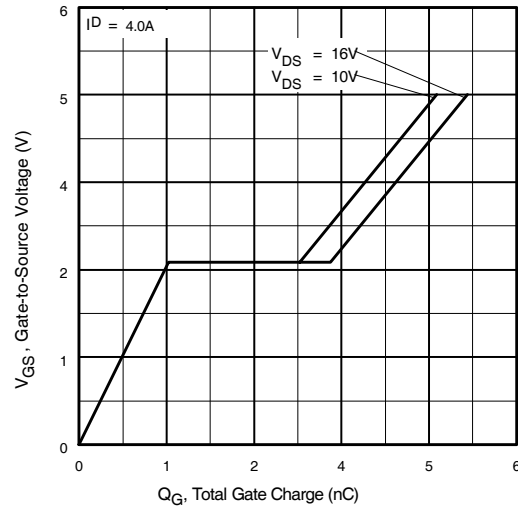


**Fig 4.** Normalized On-Resistance Vs. Temperature

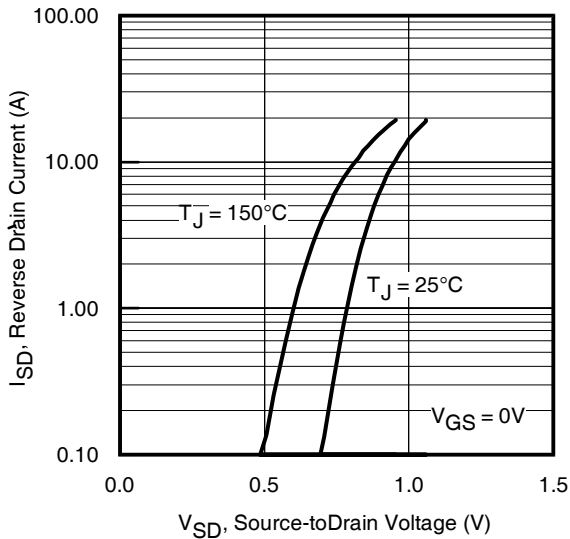
# IRF1902UPbF



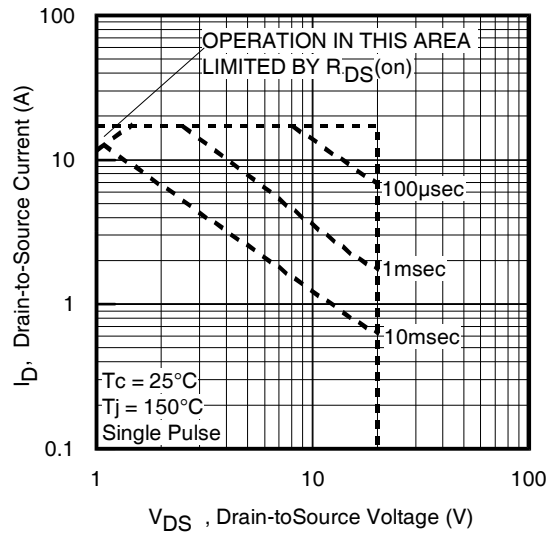
**Fig 5.** Typical Capacitance Vs. Drain-to-Source Voltage



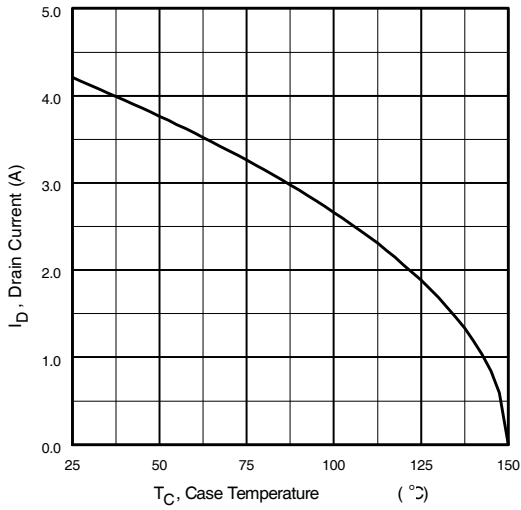
**Fig 6.** Typical Gate Charge Vs. Gate-to-Source Voltage



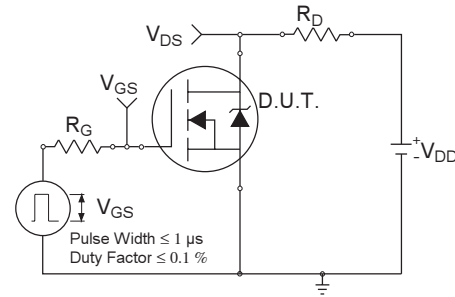
**Fig 7.** Typical Source-Drain Diode Forward Voltage



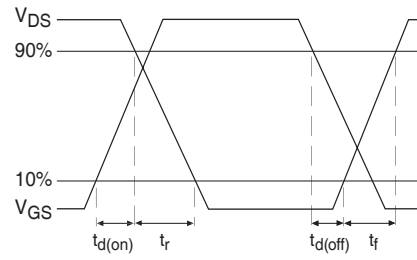
**Fig 8.** Maximum Safe Operating Area



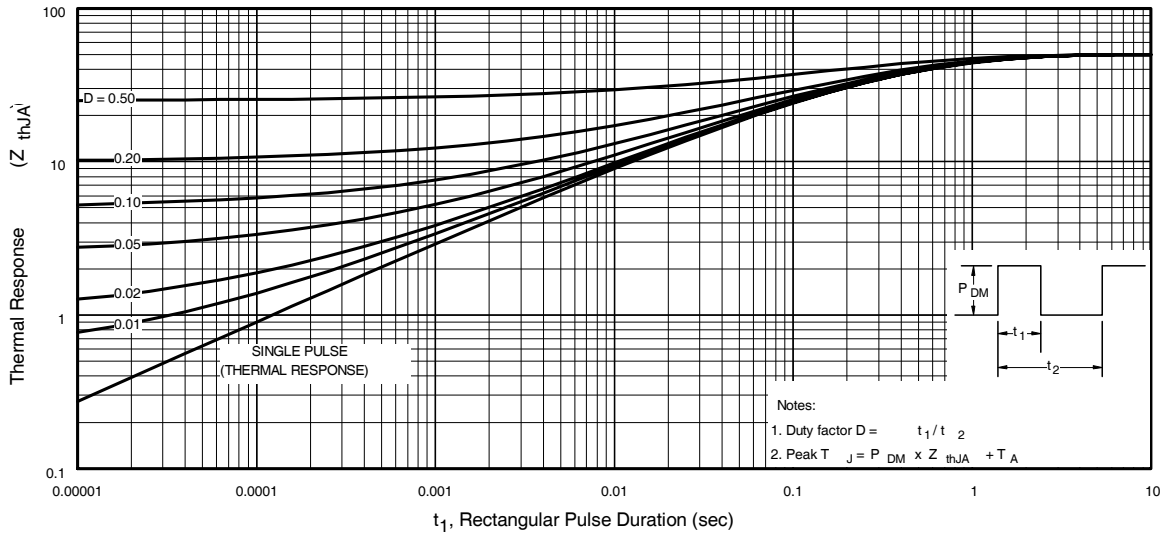
**Fig 9.** Maximum Drain Current Vs. Case Temperature



**Fig 10a.** Switching Time Test Circuit



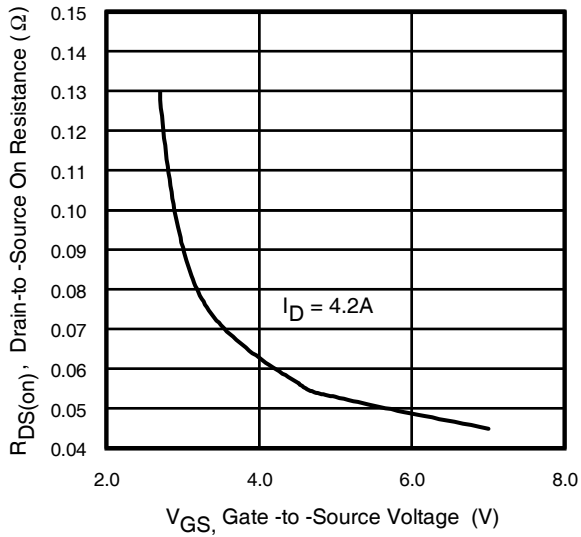
**Fig 10b.** Switching Time Waveforms



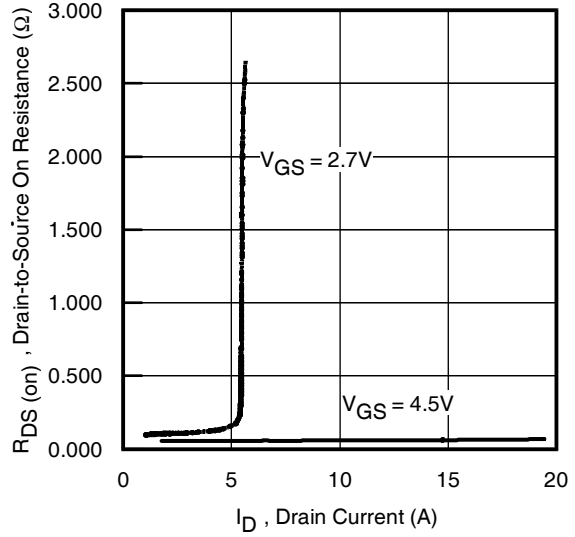
**Fig 11.** Typical Effective Transient Thermal Impedance, Junction-to-Ambient

# IRF1902UPbF

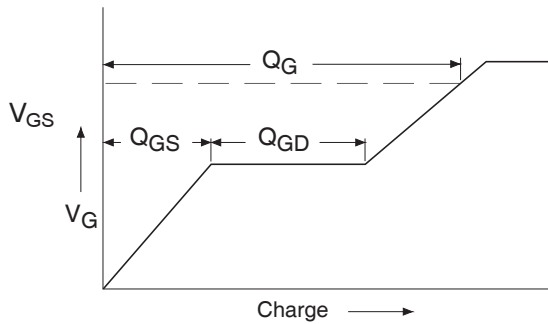
International  
**IR** Rectifier



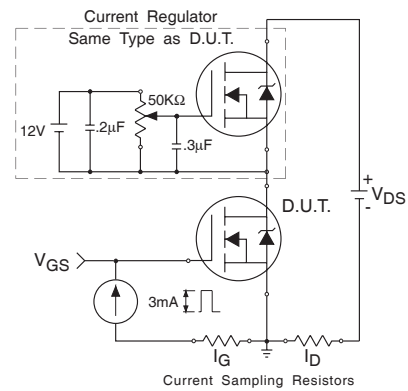
**Fig 12.** Typical On-Resistance Vs. Gate Voltage



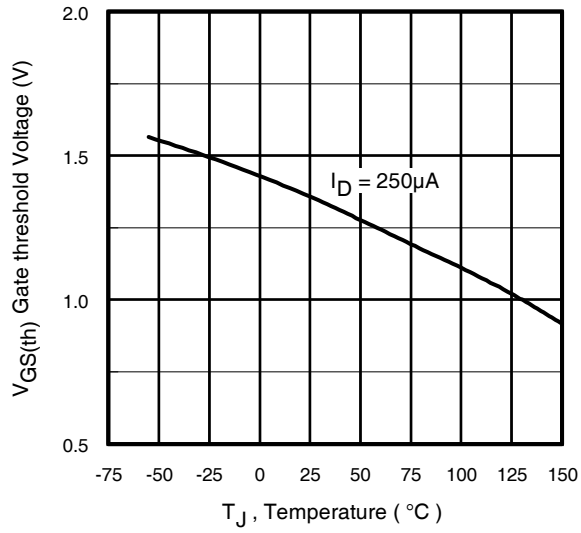
**Fig 13.** Typical On-Resistance Vs. Drain Current



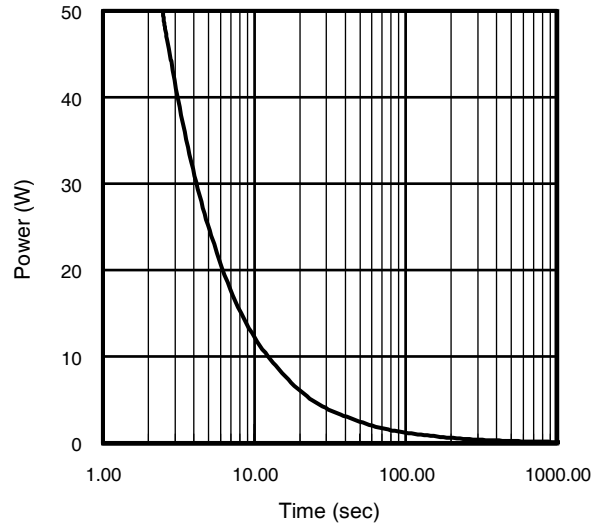
**Fig 14a.** Basic Gate Charge Waveform



**Fig 14b.** Gate Charge Test Circuit



**Fig 15.** Typical Threshold Voltage Vs. Junction Temperature



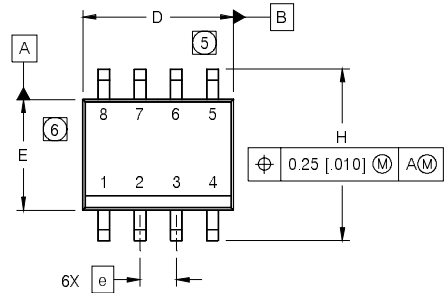
**Fig 16.** Typical Power Vs. Time

# IRF1902UPbF

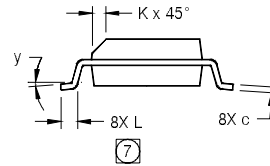
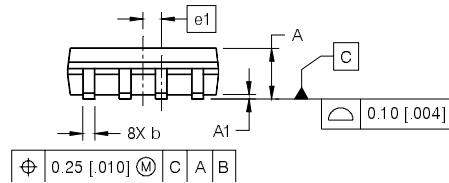
International  
**IR** Rectifier

## SO-8 Package Outline

Dimensions are shown in millimeters (inches)



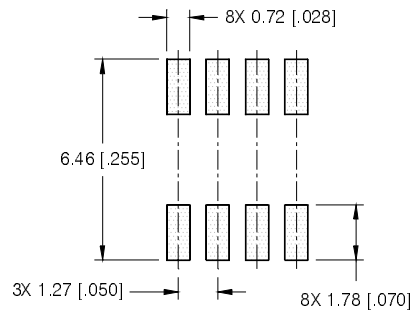
DIM	INCHES		MILLIMETERS	
	MIN	MAX	MIN	MAX
A	.0532	.0688	1.35	1.75
A1	.0040	.0098	0.10	0.25
b	.013	.020	0.33	0.51
c	.0075	.0098	0.19	0.25
D	.189	.1968	4.80	5.00
E	.1497	.1574	3.80	4.00
e	.050 BASIC		1.27 BASIC	
e1	.025 BASIC		0.635 BASIC	
H	.2284	.2440	5.80	6.20
K	.0099	.0196	0.25	0.50
L	.016	.050	0.40	1.27
y	0°	8°	0°	8°



### NOTES:

1. DIMENSIONING & TOLERANCING PER ASME Y14.5M-1994.
2. CONTROLLING DIMENSION: MILLIMETER
3. DIMENSIONS ARE SHOWN IN MILLIMETERS [INCHES].
4. OUTLINE CONFORMS TO JEDEC OUTLINE MS-012AA.
- ⑤ DIMENSION DOES NOT INCLUDE MOLD PROTRUSIONS. MOLD PROTRUSIONS NOT TO EXCEED 0.15 [.006].
- ⑥ DIMENSION DOES NOT INCLUDE MOLD PROTRUSIONS. MOLD PROTRUSIONS NOT TO EXCEED 0.25 [.010].
- ⑦ DIMENSION IS THE LENGTH OF LEAD FOR SOLDERING TO A SUBSTRATE.

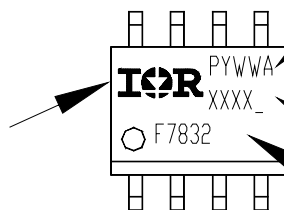
### FOOTPRINT



## SO-8 Part Marking

EXAMPLE: THIS IS AN IRF7832U (MOSFET)

INTERNATIONAL  
RECTIFIER  
LOGO



DATE CODE (YWW)

P = DESIGNATES LEAD - FREE  
PRODUCT (OPTIONAL)

Y = LAST DIGIT OF THE YEAR

WW = WEEK

A = ASSEMBLY SITE CODE

LOT CODE

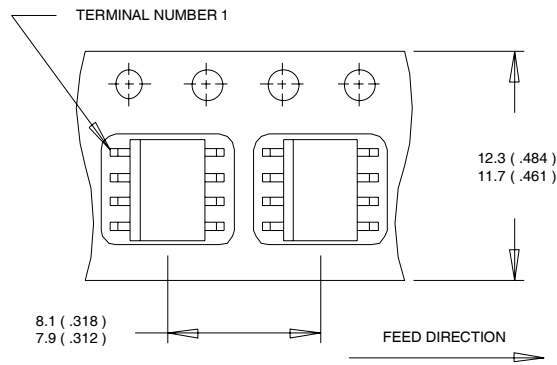
PART NUMBER



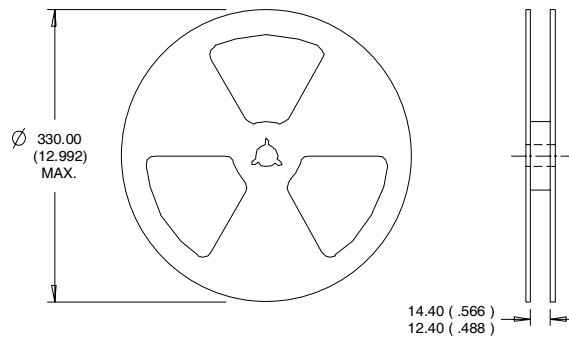
## SO-8 Tape and Reel

Dimensions are shown in millimeters (inches)

www.DataSheet4U.com



- NOTES:
1. CONTROLLING DIMENSION : MILLIMETER.
  2. ALL DIMENSIONS ARE SHOWN IN MILLIMETERS(INCHES).
  3. OUTLINE CONFORMS TO EIA-481 & EIA-541.



- NOTES :
1. CONTROLLING DIMENSION : MILLIMETER.
  2. OUTLINE CONFORMS TO EIA-481 & EIA-541.

Data and specifications subject to change without notice.  
 This product has been designed and qualified for the Consumer market.  
 Qualifications Standards can be found on IR's Web site.