

## Super FAP-G Series

## N-CHANNEL SILICON POWER MOSFET

### Features

- High speed switching
- Low on-resistance
- No secondary breakdown
- Low driving power
- Avalanche-proof

### Applications

- Switching regulators
- UPS (Uninterruptible Power Supply)
- DC-DC converters

### Maximum ratings and characteristic Absolute maximum ratings

(Tc=25°C unless otherwise specified)

Item	Symbol	Ratings	Unit	Remarks
Drain-source voltage	V <sub>DS</sub>	600	V	
	V <sub>DSX</sub>	600	V	V <sub>GS</sub> =-30V
Continuous drain current	I <sub>D</sub>	±16	A	
Pulsed drain current	I <sub>D(puls)</sub>	±64	A	
Gate-source voltage	V <sub>GS</sub>	±30	V	
Repetitive or non-repetitive	I <sub>AR</sub>	16	A	T <sub>ch</sub> ≤ 150°C
Maximum avalanche energy	E <sub>AS</sub>	242.7	mJ	*1
Maximum drain-source dV/dt	dV <sub>DS</sub> /dt	20	kV/μs	V <sub>DS</sub> ≤ 600V
Peak diode recovery dV/dt	dV/dt	5	kV/μs	*2
Max. power dissipation	P <sub>D</sub>	1.67	W	T <sub>a</sub> =25°C
		270		T <sub>c</sub> =25°C
Operating and storage temperature range	T <sub>ch</sub>	+150	°C	
	T <sub>stg</sub>	-55 to +150	°C	
Isolation voltage	V <sub>ISO</sub>	2	kVrms	t=60sec, f=60Hz

\*1 L=1.74mH, V<sub>CC</sub>=60V, See to Avalanche Energy Graph

\*2 I<sub>F</sub> ≤ -I<sub>D</sub>, -di/dt=50A/μs, V<sub>CC</sub> ≤ BV<sub>DSS</sub>, T<sub>ch</sub> ≤ 150°C

### Electrical characteristics (Tc =25°C unless otherwise specified)

Item	Symbol	Test Conditions				
Drain-source breakdown voltage	V <sub>(BR)DSS</sub>	I <sub>D</sub> =250μA V <sub>GS</sub> =0V	600			V
Gate threshold voltage	V <sub>GS(th)</sub>	I <sub>D</sub> =250μA V <sub>DS</sub> =V <sub>GS</sub>	3.0		5.0	V
Zero gate voltage drain current	I <sub>DSS</sub>	V <sub>DS</sub> =600V V <sub>GS</sub> =0V			25	μA
		V <sub>DS</sub> =480V V <sub>GS</sub> =0V			250	
Gate-source leakage current	I <sub>GSS</sub>	V <sub>GS</sub> =±30V V <sub>DS</sub> =0V		10	100	nA
Drain-source on-state resistance	R <sub>DS(on)</sub>	I <sub>D</sub> =8A V <sub>GS</sub> =10V		0.42	0.57	Ω
Forward transconductance	g <sub>fs</sub>	I <sub>D</sub> =8A V <sub>DS</sub> =25V	6.5	13		S
Input capacitance	C <sub>iss</sub>	V <sub>DS</sub> =25V		1590	2390	pF
Output capacitance	C <sub>oss</sub>	V <sub>GS</sub> =0V		200	300	
Reverse transfer capacitance	C <sub>rss</sub>	f=1MHz		11	17	
Turn-on time t <sub>on</sub>	t <sub>d(on)</sub>	V <sub>CC</sub> =300V I <sub>D</sub> =8A		29	43.5	ns
	t <sub>r</sub>	V <sub>GS</sub> =10V		16	24	
Turn-off time t <sub>off</sub>	t <sub>d(off)</sub>	R <sub>GS</sub> =10 Ω		58	87	
	t <sub>r</sub>			8	12	
Total Gate Charge	Q <sub>G</sub>	V <sub>CC</sub> =300V		34	51	nC
Gate-Source Charge	Q <sub>GS</sub>	I <sub>D</sub> =16A		12	18	
Gate-Drain Charge	Q <sub>GD</sub>	V <sub>GS</sub> =10V		10	15	
Avalanche capability	I <sub>AV</sub>	L=1.74mH T <sub>ch</sub> =25°C	16			A
Diode forward on-voltage	V <sub>SD</sub>	I <sub>F</sub> =16A V <sub>GS</sub> =0V T <sub>ch</sub> =25°C		1.00	1.50	V
Reverse recovery time	t <sub>rr</sub>	I <sub>F</sub> =16A V <sub>GS</sub> =0V		0.68		μs
Reverse recovery charge	Q <sub>rr</sub>	-di/dt=100A/μs T <sub>ch</sub> =25°C		7.8		μC

### Thermal characteristics

Item	Symbol	Test Conditions	Min.	Typ.	Max.	Units
Thermal resistance	R <sub>th(ch-c)</sub>	channel to case			0.463	°C/W
	R <sub>th(ch-a)</sub>	channel to ambient			75.0	°C/W

### Outline Drawings [mm]

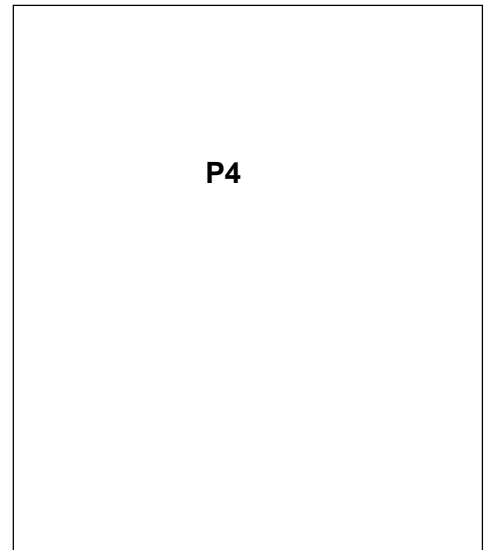

### Equivalent circuit schematic

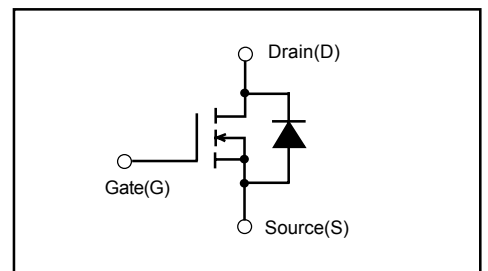

Characteristics

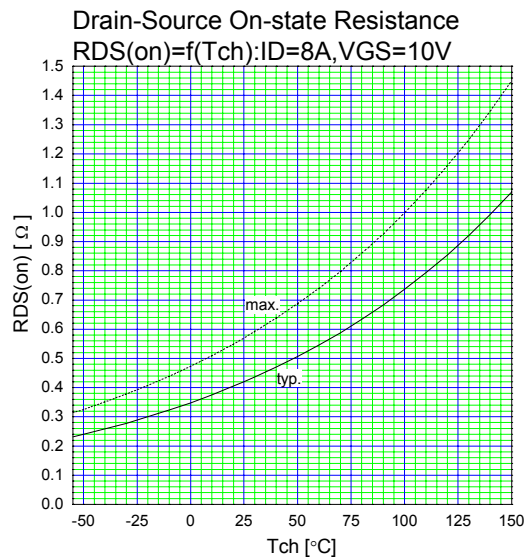
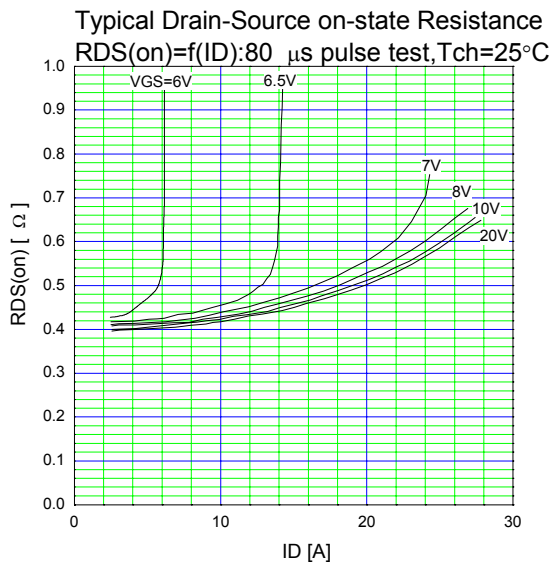
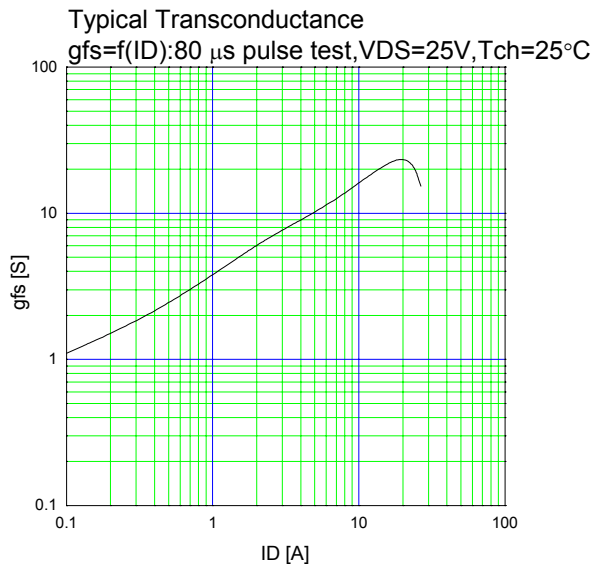
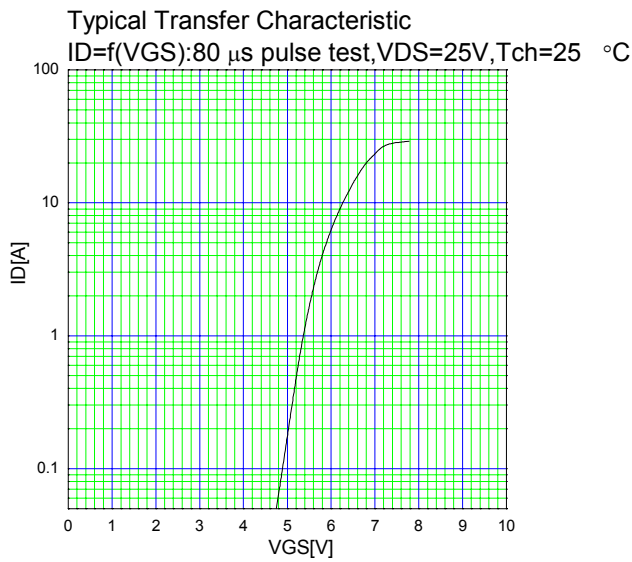
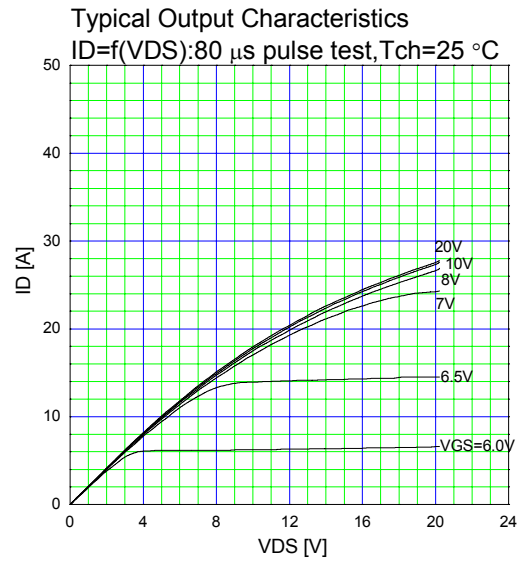
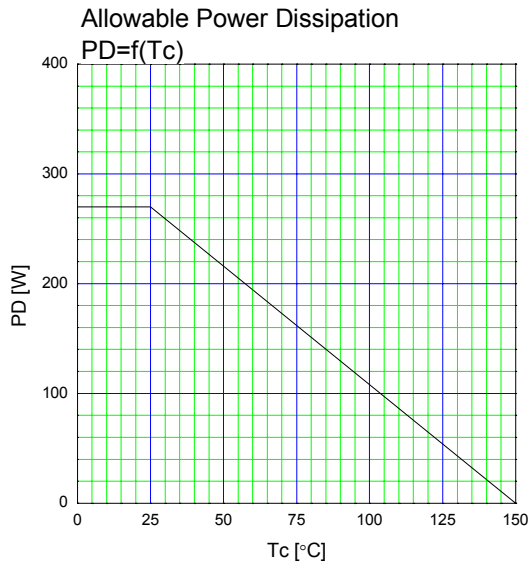

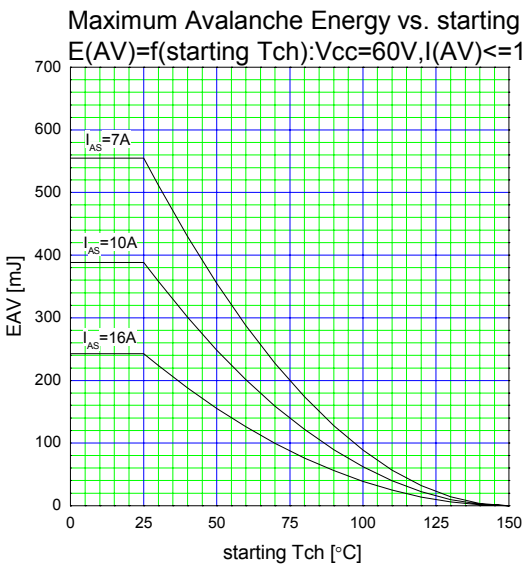
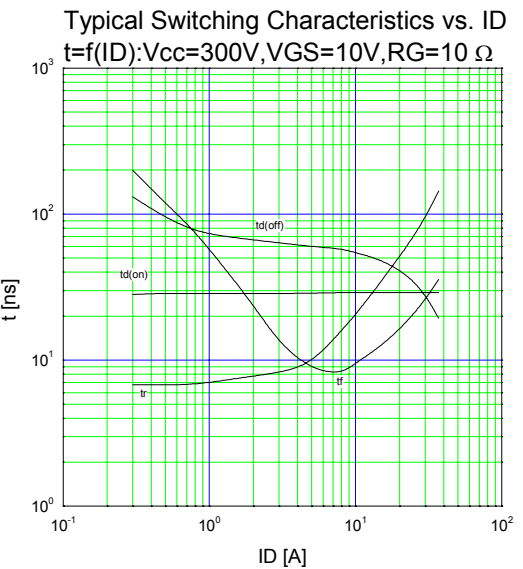
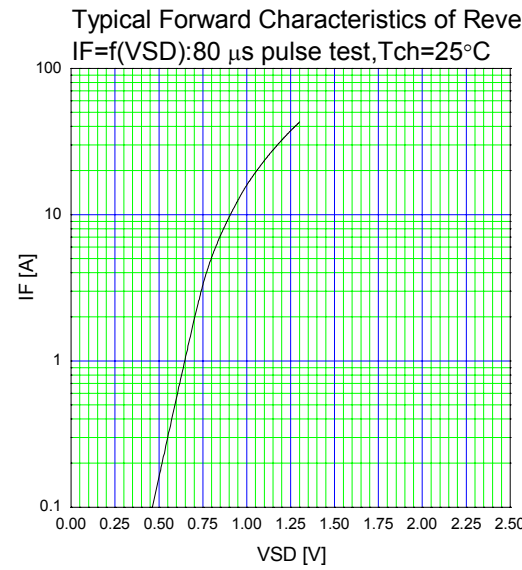
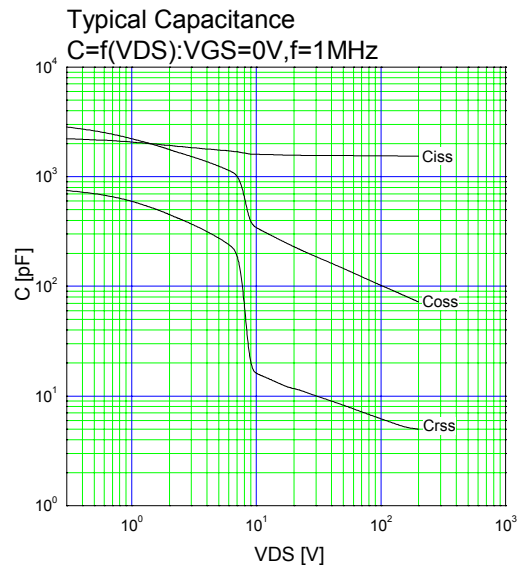
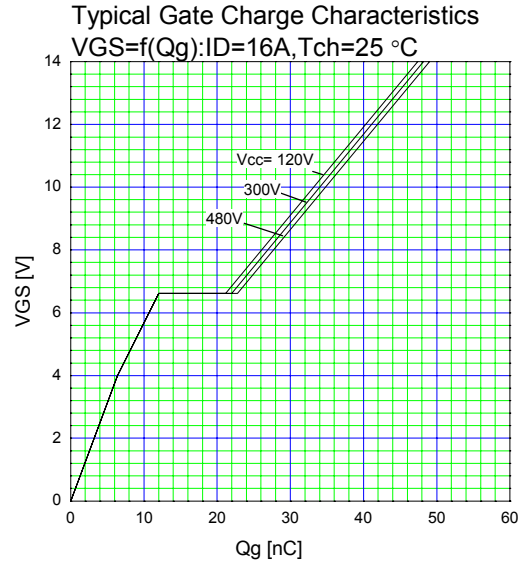
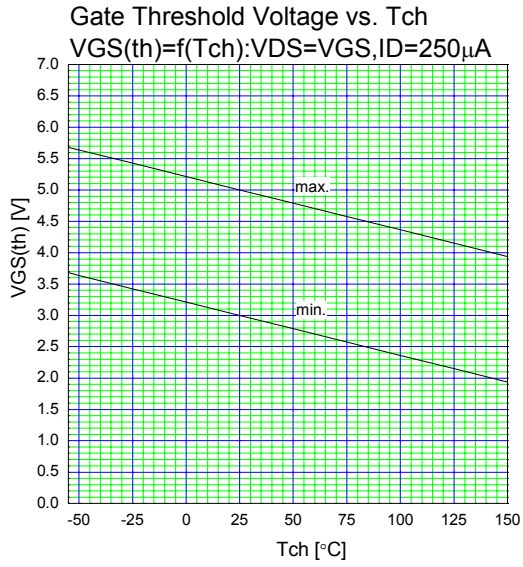

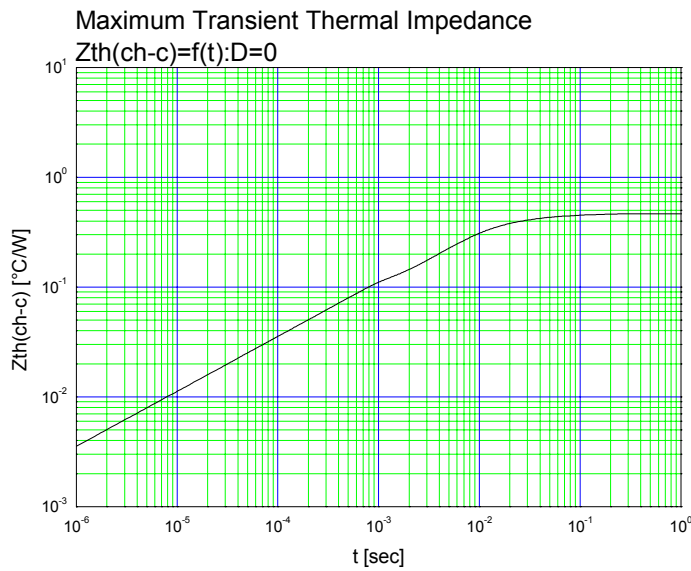
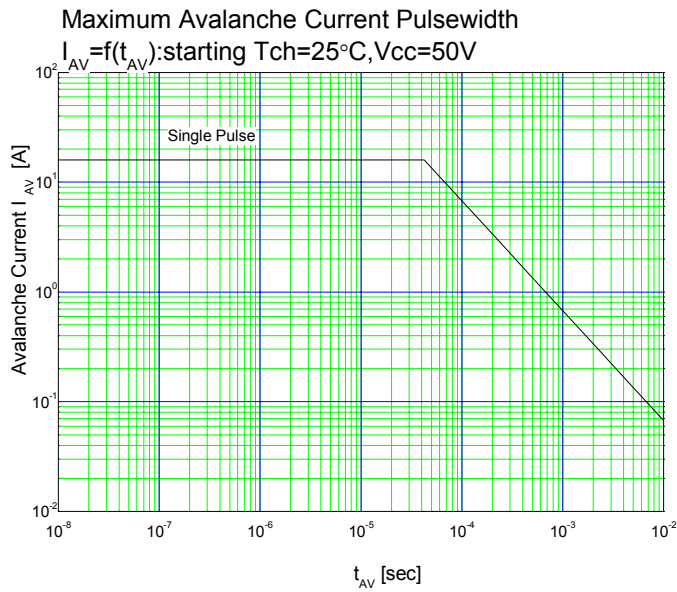

■ Outline Drawings [mm]

T-pack(L)

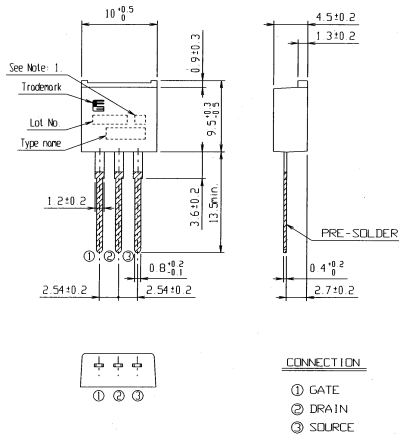

Note: 1. Guaranteed mark of avalanche ruggedness.

T-pack(S)

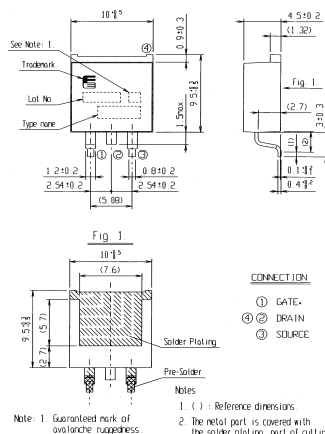

T-pack(SJ) [D2-pack]

