

74VCX16245

Low-Voltage 1.8/2.5/3.3V 16-Bit Transceiver With 3.6 V-Tolerant Inputs and Outputs (3-State, Non-Inverting)

The 74VCX16245 is an advanced performance, non-inverting 16-bit transceiver. It is designed for very high-speed, very low-power operation in 1.8 V, 2.5 V or 3.3 V systems.

When operating at 2.5 V (or 1.8 V) the part is designed to tolerate voltages it may encounter on either inputs or outputs when interfacing to 3.3 V busses. It is guaranteed to be over-voltage tolerant to 3.6 V.

The VCX16245 is designed with byte control. It can be operated as two separate octals, or with the controls tied together, as a 16-bit wide function. The Transmit/Receive ($T/\bar{R}n$) inputs determine the direction of data flow through the bi-directional transceiver. Transmit (active-HIGH) enables data from A ports to B ports; Receive (active-LOW) enables data from B to A ports. The Output Enable (\overline{OEn}), when HIGH, disable both A and B ports by placing them in a HIGH Z condition.

- Designed for Low Voltage Operation: $V_{CC} = 1.65\text{--}3.6\text{ V}$
- 3.6 V Tolerant Inputs and Outputs
- High Speed Operation: 2.5 ns max for 3.0 to 3.6 V
3.0 ns max for 2.3 to 2.7 V
6.0 ns max for 1.65 to 1.95 V
- Static Drive: $\pm 24\text{ mA}$ Drive at 3.0 V
 $\pm 18\text{ mA}$ Drive at 2.3 V
 $\pm 6\text{ mA}$ Drive at 1.65 V
- Supports Live Insertion and Withdrawal
- I_{OFF} Specification Guarantees High Impedance When $V_{CC} = 0\text{ V}$
- Near Zero Static Supply Current in All Three Logic States (20 μA)
Substantially Reduces System Power Requirements
- Latchup Performance Exceeds $\pm 250\text{ mA}$ @ 125°C
- ESD Performance: Human Body Model >2000 V; Machine Model >200 V



ON Semiconductor

<http://onsemi.com>

MARKING DIAGRAM

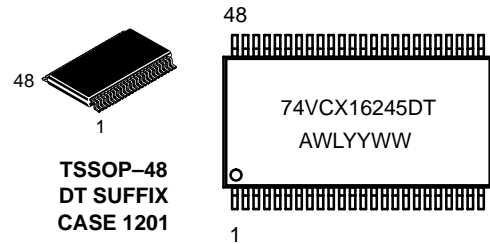

A = Assembly Location
WL = Wafer Lot
YY = Year
WW = Work Week

ORDERING INFORMATION

Device	Package	Shipping
74VCX16245DT	TSSOP	39 / Rail
74VCX16245DTR	TSSOP	2500 / Reel

74VCX16245

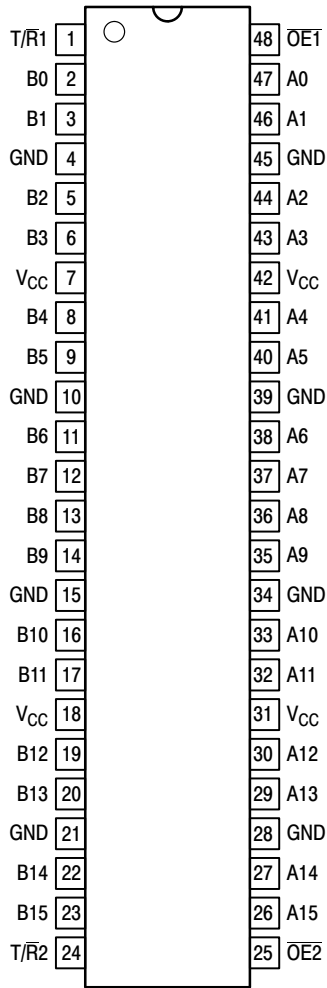

Figure 1. 48-Lead Pinout
(Top View)

PIN NAMES

Pins	Function
$\overline{OE}n$	Output Enable Inputs
$T/\overline{R}n$	Transmit/Receive Inputs
A0–A15	Side A Inputs or 3–State Outputs
B0–B15	Side B Inputs or 3–State Outputs

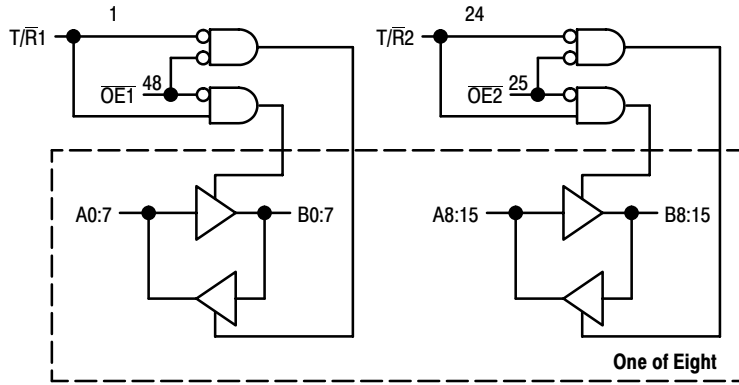

Figure 2. Logic Diagram

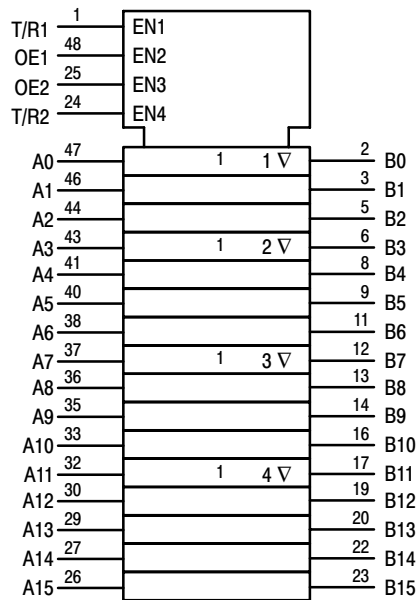

Figure 3. IEC Logic Diagram

Inputs		Outputs	Inputs		Outputs
$\overline{OE}1$	$T/\overline{R}1$		$\overline{OE}2$	$T/\overline{R}2$	
L	L	Bus B0:7 Data to Bus A0:7	L	L	Bus B8:15 Data to Bus A8:15
L	H	Bus A0:7 Data to Bus B0:7	L	H	Bus A8:15 Data to Bus B8:15
H	X	High Z State on A0:7, B0:7	H	X	High Z State on A8:15, B8:15

H = High Voltage Level; L = Low Voltage Level; X = High or Low Voltage Level and Transitions Are Acceptable

74VCX16245

ABSOLUTE MAXIMUM RATINGS*

Symbol	Parameter	Value	Condition	Unit
V_{CC}	DC Supply Voltage	-0.5 to +4.6		V
V_I	DC Input Voltage	$-0.5 \leq V_I \leq +4.6$		V
V_O	DC Output Voltage	$-0.5 \leq V_O \leq +4.6$	Output in 3-State	V
		$-0.5 \leq V_O \leq V_{CC} + 0.5$	Note 1.; Outputs Active	V
I_{IK}	DC Input Diode Current	-50	$V_I < GND$	mA
I_{OK}	DC Output Diode Current	-50	$V_O < GND$	mA
		+50	$V_O > V_{CC}$	mA
I_O	DC Output Source/Sink Current	± 50		mA
I_{CC}	DC Supply Current Per Supply Pin	± 100		mA
I_{GND}	DC Ground Current Per Ground Pin	± 100		mA
T_{STG}	Storage Temperature Range	-65 to +150		°C

* Absolute maximum continuous ratings are those values beyond which damage to the device may occur. Exposure to these conditions or conditions beyond those indicated may adversely affect device reliability. Functional operation under absolute-maximum-rated conditions is not implied.

1. I_O absolute maximum rating must be observed.

RECOMMENDED OPERATING CONDITIONS

Symbol	Parameter	Min	Typ	Max	Unit	
V_{CC}	Supply Voltage	Operating	1.65	3.3	3.6	V
		Data Retention Only	1.2	3.3	3.6	
V_I	Input Voltage	-0.3		3.6	V	
V_O	Output Voltage	(Active State)	0		V_{CC}	V
		(3-State)	0		3.6	
I_{OH}	HIGH Level Output Current, $V_{CC} = 3.0V - 3.6V$			-24	mA	
I_{OL}	LOW Level Output Current, $V_{CC} = 3.0V - 3.6V$			24	mA	
I_{OH}	HIGH Level Output Current, $V_{CC} = 2.3V - 2.7V$			-18	mA	
I_{OL}	LOW Level Output Current, $V_{CC} = 2.3V - 2.7V$			18	mA	
I_{OH}	HIGH Level Output Current, $V_{CC} = 1.65 - 1.95V$			-6	mA	
I_{OL}	LOW Level Output Current, $V_{CC} = 1.65 - 1.95V$			6	mA	
T_A	Operating Free-Air Temperature	-40		+85	°C	
$\Delta t/\Delta V$	Input Transition Rise or Fall Rate, V_{IN} from 0.8V to 2.0V, $V_{CC} = 3.0V$	0		10	ns/V	

74VCX16245

DC ELECTRICAL CHARACTERISTICS

Symbol	Characteristic	Condition	T _A = -40°C to +85°C		Unit
			Min	Max	
V _{IH}	HIGH Level Input Voltage (Note 2.)	1.65V ≤ V _{CC} < 2.3V	0.65 x V _{CC}		V
		2.3V ≤ V _{CC} ≤ 2.7V	1.6		
		2.7V < V _{CC} ≤ 3.6V	2.0		
V _{IL}	LOW Level Input Voltage (Note 2.)	1.65V ≤ V _{CC} < 2.3V		0.35 x V _{CC}	V
		2.3V ≤ V _{CC} ≤ 2.7V		0.7	
		2.7V < V _{CC} ≤ 3.6V		0.8	
V _{OH}	HIGH Level Output Voltage	1.65V ≤ V _{CC} ≤ 3.6V; I _{OH} = -100μA	V _{CC} - 0.2		V
		V _{CC} = 1.65V; I _{OH} = -6mA	1.25		
		V _{CC} = 2.3V; I _{OH} = -6mA	2.0		
		V _{CC} = 2.3V; I _{OH} = -12mA	1.8		
		V _{CC} = 2.3V; I _{OH} = -18mA	1.7		
		V _{CC} = 2.7V; I _{OH} = -12mA	2.2		
		V _{CC} = 3.0V; I _{OH} = -18mA	2.4		
V _{OL}	LOW Level Output Voltage	1.65V ≤ V _{CC} ≤ 3.6V; I _{OL} = 100μA		0.2	V
		V _{CC} = 1.65V; I _{OL} = 6mA		0.3	
		V _{CC} = 2.3V; I _{OL} = 12mA		0.4	
		V _{CC} = 2.3V; I _{OL} = 18mA		0.6	
		V _{CC} = 2.7V; I _{OL} = 12mA		0.4	
		V _{CC} = 3.0V; I _{OL} = 18mA		0.4	
		V _{CC} = 3.0V; I _{OL} = 24mA		0.55	
I _I	Input Leakage Current	1.65V ≤ V _{CC} ≤ 3.6V; 0V ≤ V _I ≤ 3.6V		±5.0	μA
I _{OZ}	3-State Output Current	1.65V ≤ V _{CC} ≤ 3.6V; 0V ≤ V _O ≤ 3.6V; V _I = V _{IH} or V _{IL}		±10	μA
I _{OFF}	Power-Off Leakage Current	V _{CC} = 0V; V _I or V _O = 3.6V		10	μA
I _{CC}	Quiescent Supply Current (Note 3.)	1.65V ≤ V _{CC} ≤ 3.6V; V _I = GND or V _{CC}		20	μA
		1.65V ≤ V _{CC} ≤ 3.6V; 3.6V ≤ V _I , V _O ≤ 3.6V		±20	μA
ΔI _{CC}	Increase in I _{CC} per Input	2.7V < V _{CC} ≤ 3.6V; V _{IH} = V _{CC} - 0.6V		750	μA

2. These values of V_I are used to test DC electrical characteristics only.

3. Outputs disabled or 3-state only.

AC CHARACTERISTICS (Note 4.; t_R = t_F = 2.0ns; C_L = 30pF; R_L = 500Ω)

Symbol	Parameter	Waveform	Limits						Unit
			T _A = -40°C to +85°C						
			V _{CC} = 3.0V to 3.6V		V _{CC} = 2.3V to 2.7V		V _{CC} = 1.65 to 1.95V		
		Min	Max	Min	Max	Min	Max		
t _{PLH}	Propagation Delay	1	0.8	2.5	1.0	3.0	1.5	6.0	ns
t _{PHL}	Input to Output		0.8	2.5	1.0	3.0	1.5	6.0	
t _{PZH}	Output Enable Time to	2	0.8	3.8	1.0	4.9	1.5	9.3	ns
t _{PZL}	High and Low Level		0.8	3.8	1.0	4.9	1.5	9.3	
t _{PHZ}	Output Disable Time From	2	0.8	3.7	1.0	4.2	1.5	7.6	ns
t _{PLZ}	High and Low Level		0.8	3.7	1.0	4.2	1.5	7.6	
t _{OSSL}	Output-to-Output Skew			0.5		0.5		0.75	ns
t _{OSLH}	(Note 5.)			0.5		0.5		0.75	

4. For C_L = 50pF, add approximately 300ps to the AC maximum specification.

5. Skew is defined as the absolute value of the difference between the actual propagation delay for any two separate outputs of the same device. The specification applies to any outputs switching in the same direction, either HIGH-to-LOW (t_{OSSL}) or LOW-to-HIGH (t_{OSLH}); parameter guaranteed by design.

74VCX16245

DYNAMIC SWITCHING CHARACTERISTICS

Symbol	Characteristic	Condition	T _A = +25°C	
			Typ	Unit
V _{OLP}	Dynamic LOW Peak Voltage (Note 6.)	V _{CC} = 1.8V, C _L = 30pF, V _{IH} = V _{CC} , V _{IL} = 0V	0.25	V
		V _{CC} = 2.5V, C _L = 30pF, V _{IH} = V _{CC} , V _{IL} = 0V	0.6	
		V _{CC} = 3.3V, C _L = 30pF, V _{IH} = V _{CC} , V _{IL} = 0V	0.8	
V _{OLV}	Dynamic LOW Valley Voltage (Note 6.)	V _{CC} = 1.8V, C _L = 30pF, V _{IH} = V _{CC} , V _{IL} = 0V	-0.25	V
		V _{CC} = 2.5V, C _L = 30pF, V _{IH} = V _{CC} , V _{IL} = 0V	-0.6	
		V _{CC} = 3.3V, C _L = 30pF, V _{IH} = V _{CC} , V _{IL} = 0V	-0.8	
V _{OHV}	Dynamic HIGH Valley Voltage (Note 7.)	V _{CC} = 1.8V, C _L = 30pF, V _{IH} = V _{CC} , V _{IL} = 0V	1.5	V
		V _{CC} = 2.5V, C _L = 30pF, V _{IH} = V _{CC} , V _{IL} = 0V	1.9	
		V _{CC} = 3.3V, C _L = 30pF, V _{IH} = V _{CC} , V _{IL} = 0V	2.2	

6. Number of outputs defined as “n”. Measured with “n-1” outputs switching from HIGH-to-LOW or LOW-to-HIGH. The remaining output is measured in the LOW state.

7. Number of outputs defined as “n”. Measured with “n-1” outputs switching from HIGH-to-LOW or LOW-to-HIGH. The remaining output is measured in the HIGH state.

CAPACITIVE CHARACTERISTICS

Symbol	Parameter	Condition	Typical	Unit
C _{IN}	Input Capacitance	Note 8.	6	pF
C _{OUT}	Output Capacitance	Note 8.	7	pF
C _{PD}	Power Dissipation Capacitance	Note 8., 10MHz	20	pF

8. V_{CC} = 1.8, 2.5 or 3.3V; V_I = 0V or V_{CC}.

74VCX16245

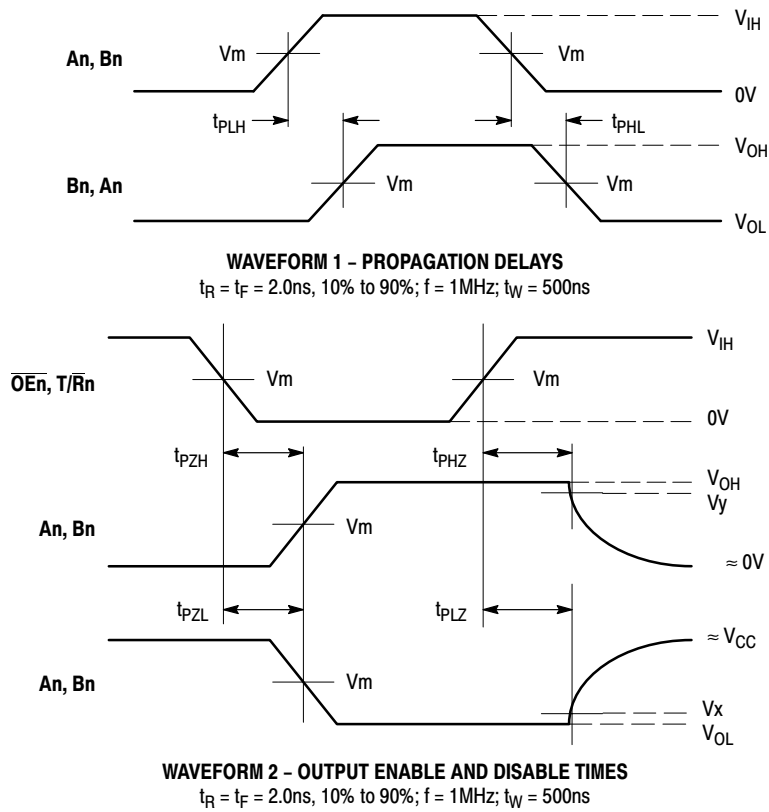
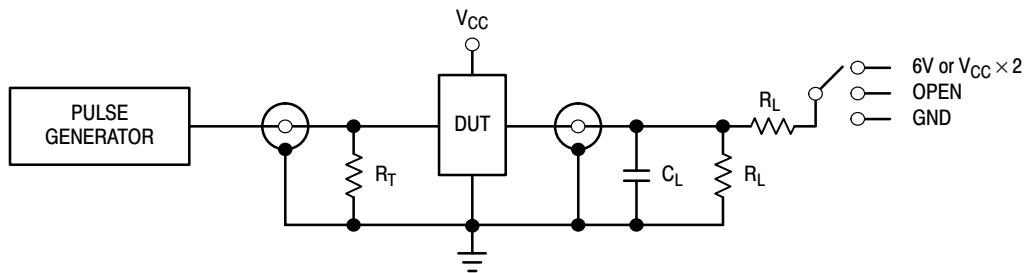

Figure 4. AC Waveforms

Symbol	V _{CC}		
	3.3V ±0.3V	2.5V ±0.2V	1.8V ±0.15V
V _{IH}	2.7V	V _{CC}	V _{CC}
V _m	1.5V	V _{CC} /2	V _{CC} /2
V _x	V _{OL} + 0.3V	V _{OL} + 0.15V	V _{OL} + 0.15V
V _y	V _{OH} - 0.3V	V _{OH} - 0.15V	V _{OH} - 0.15V



TEST	SWITCH
t_{PLH} , t_{PHL}	Open
t_{PZL} , t_{PLZ}	6V at V _{CC} = 3.3 ±0.3V; V _{CC} × 2 at V _{CC} = 2.5 ±0.2V; 1.8V ±0.15V
t_{PZH} , t_{PHZ}	GND

$C_L = 30\text{pF}$ or equivalent (Includes jig and probe capacitance)
 $R_L = 500\Omega$ or equivalent
 $R_T = Z_{OUT}$ of pulse generator (typically 50Ω)

Figure 5. Test Circuit

74VCX16245

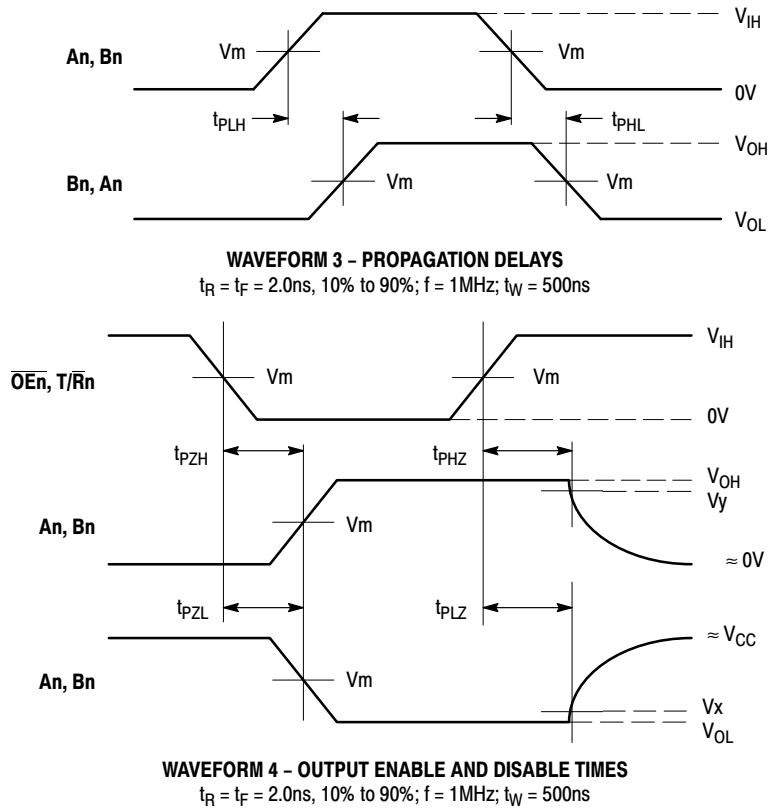
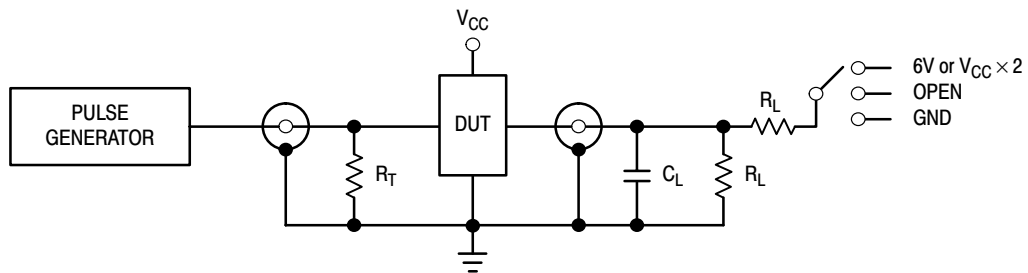

Figure 6. AC Waveforms

Symbol	V _{CC}	
	3.3V ±0.3V	2.7V
V _{IH}	2.7V	2.7V
V _m	1.5V	1.5V
V _x	V _{OL} + 0.3V	V _{OL} + 0.3V
V _y	V _{OH} - 0.3V	V _{OH} - 0.3V



TEST	SWITCH
t _{PLH} , t _{PHL}	Open
t _{PZL} , t _{PLZ}	6V at V _{CC} = 3.3 ±0.3V; V _{CC} × 2 at V _{CC} = 2.5 ±0.2V; 1.8 ±0.15V
t _{PZH} , t _{PHZ}	GND

C_L = 50pF or equivalent (Includes jig and probe capacitance)

R_L = 500Ω or equivalent

R_T = Z_{OUT} of pulse generator (typically 50Ω)

Figure 7. Test Circuit

74VCX16245

AC CHARACTERISTICS ($t_R = t_F = 2.0\text{ns}$; $C_L = 50\text{pF}$; $R_L = 500\Omega$)

Symbol	Parameter	Waveform	Limits				Unit
			$T_A = -40^\circ\text{C to } +85^\circ\text{C}$				
			$V_{CC} = 3.0\text{V to } 3.6\text{V}$		$V_{CC} = 2.7\text{V}$		
			Min	Max	Min	Max	
t_{PLH} t_{PHL}	Propagation Delay Input to Output	3	1.0 1.0	3.0 3.0		3.6 3.6	ns
t_{PZH} t_{PZL}	Output Enable Time to High and Low Level	4	1.0 1.0	4.4 4.4		5.4 5.4	ns
t_{PHZ} t_{PLZ}	Output Disable Time From High and Low Level	4	1.0 1.0	4.1 4.1		4.6 4.6	ns
t_{OSHL} t_{OSLH}	Output-to-Output Skew (Note 9.)			0.5 0.5		0.5 0.5	ns

9. Skew is defined as the absolute value of the difference between the actual propagation delay for any two separate outputs of the same device. The specification applies to any outputs switching in the same direction, either HIGH-to-LOW (t_{OSHL}) or LOW-to-HIGH (t_{OSLH}); parameter guaranteed by design.

74VCX16245

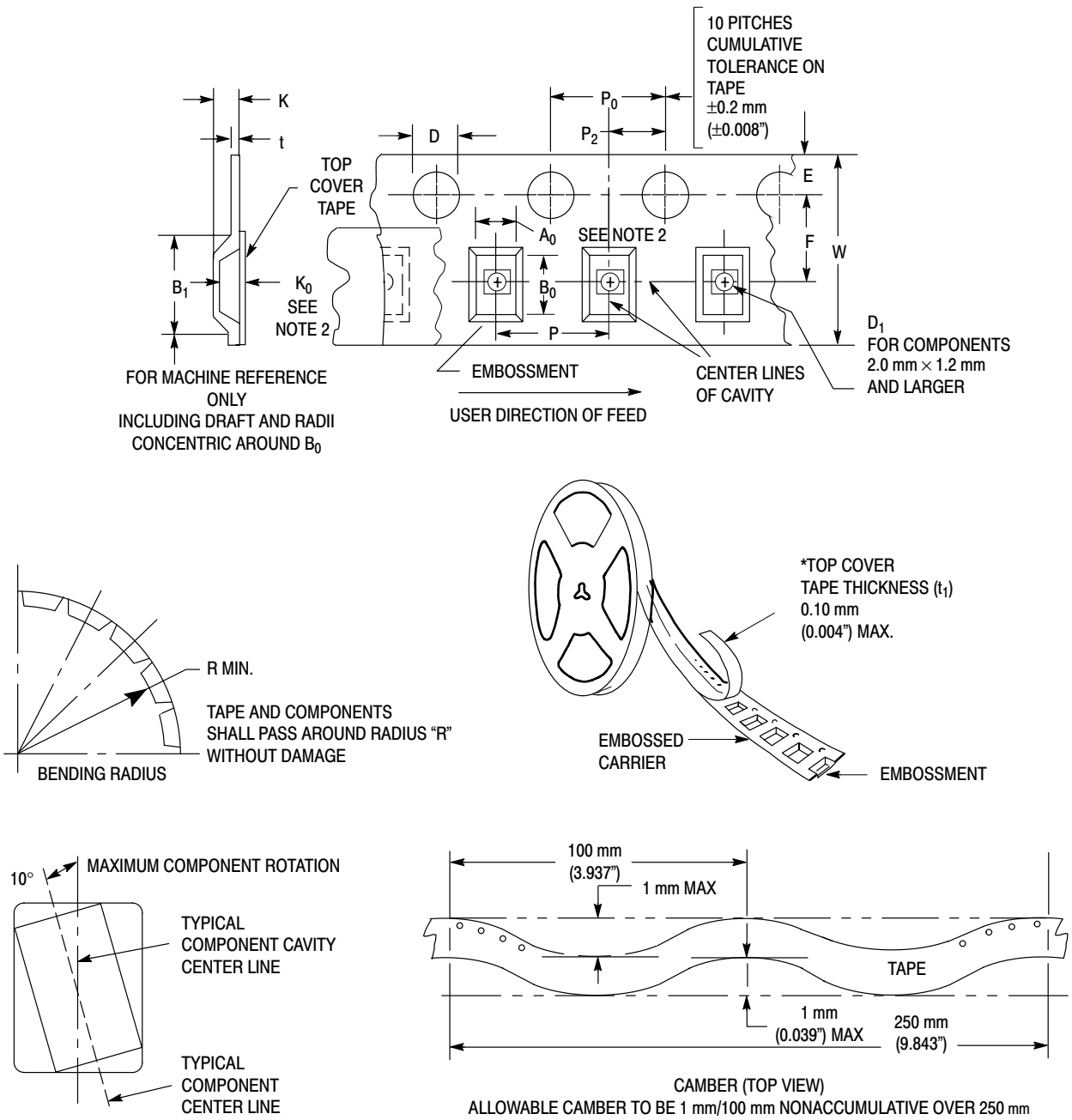

Figure 8. Carrier Tape Specifications

EMBOSSED CARRIER DIMENSIONS (See Notes 1 and 2)

Tape Size	B_1 Max	D	D_1	E	F	K	P	P_0	P_2	R	T	W
24mm	20.1mm (0.791")	1.5 + 0.1mm - 0.0 (0.059 +0.004" -0.0)	1.5mm Min (0.060")	1.75 ± 0.1 mm (0.069 ± 0.004 ")	11.5 ± 0.10 mm (0.453 ± 0.004 ")	11.9 mm Max (0.468")	16.0 ± 0.1 mm (0.63 ± 0.004 ")	4.0 ± 0.1 mm (0.157 ± 0.004 ")	2.0 ± 0.1 mm (0.079 ± 0.004 ")	30 mm (1.18")	0.6 mm (0.024")	24.3 mm (0.957")

1. Metric Dimensions Govern—English are in parentheses for reference only.
2. A_0 , B_0 , and K_0 are determined by component size. The clearance between the components and the cavity must be within 0.05 mm min to 0.50 mm max. The component cannot rotate more than 10° within the determined cavity.

74VCX16245

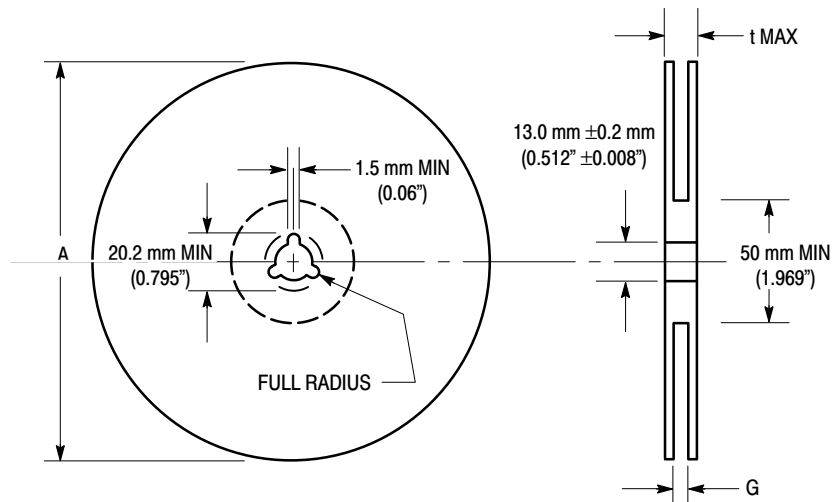

Figure 9. Reel Dimensions

REEL DIMENSIONS

Tape Size	A Max	G	t Max
24 mm	360 mm (14.173")	24.4 mm + 2.0 mm, -0.0 (0.961" + 0.078", -0.00)	30.4 mm (1.197")

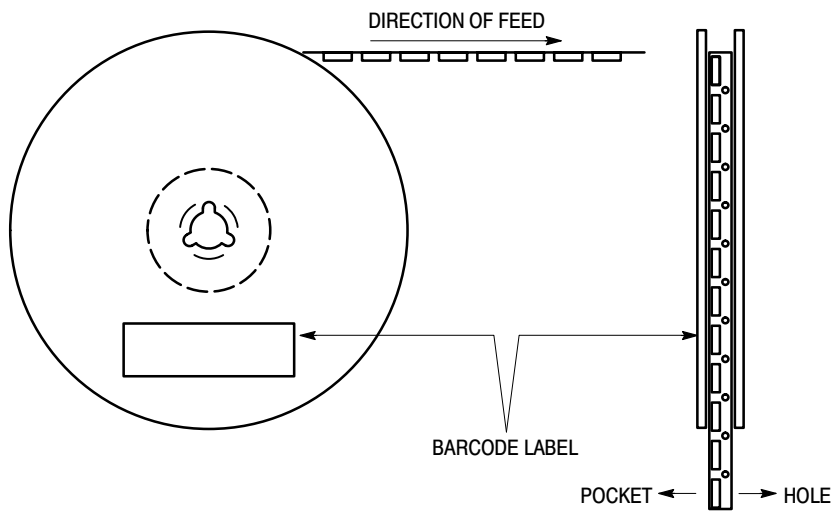

Figure 10. Reel Winding Direction

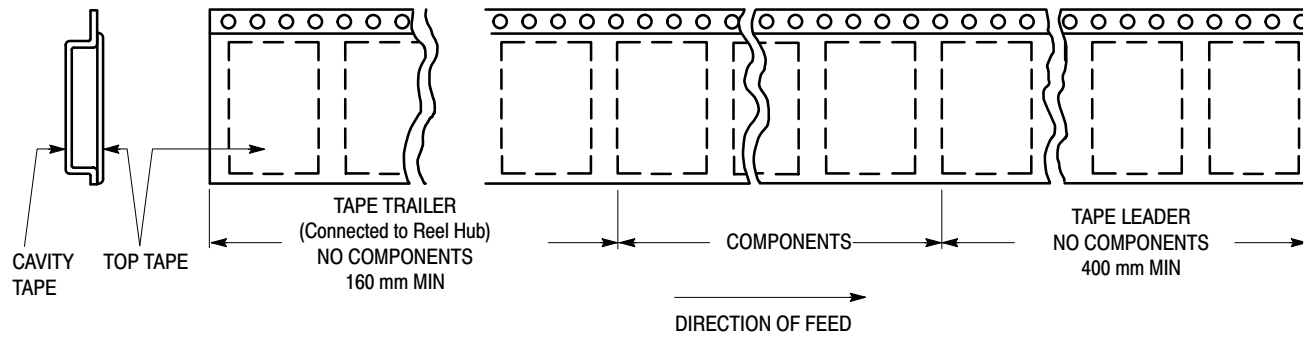

Figure 11. Tape Ends for Finished Goods

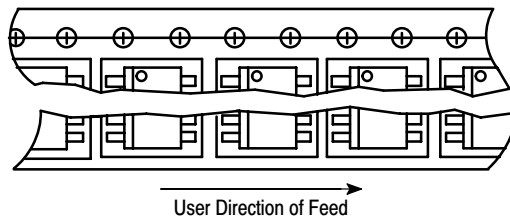

Figure 12. Reel Configuration

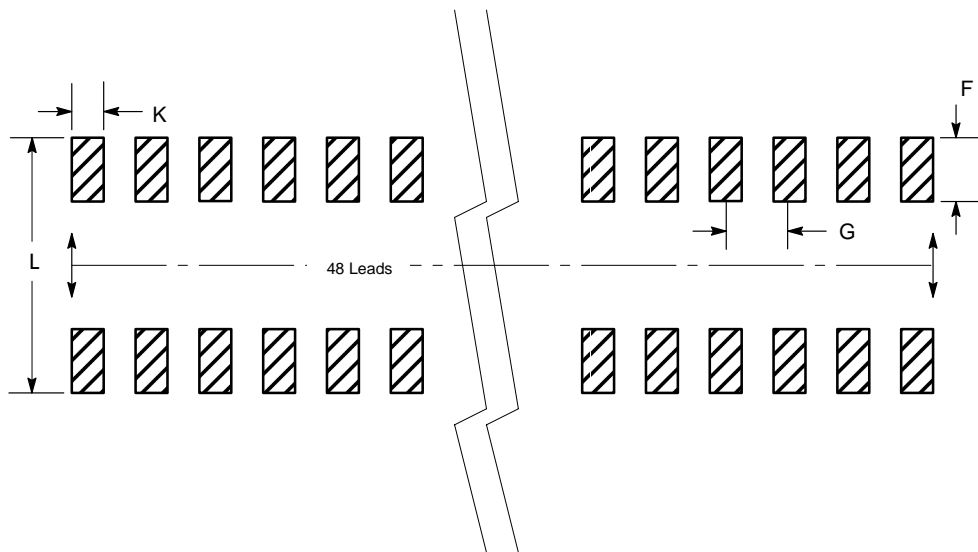
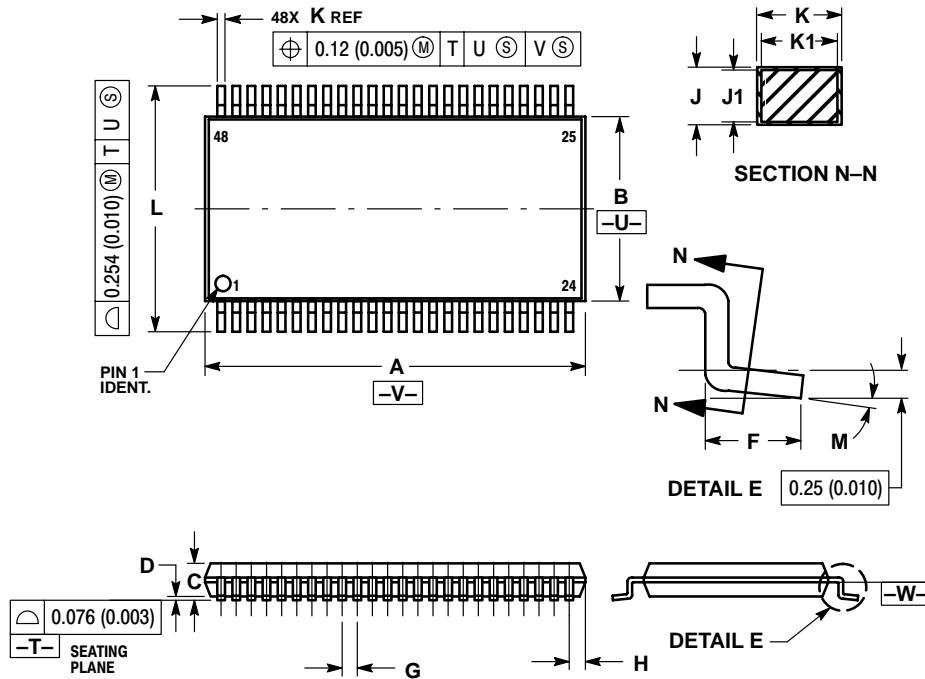

Figure 13. Package Footprint

74VCX16245

PACKAGE DIMENSIONS

TSSOP
DT SUFFIX
CASE 1201-01
ISSUE A



NOTES:

1. DIMENSIONING AND TOLERANCING PER ANSI Y14.5M, 1982.
2. CONTROLLING DIMENSION: MILLIMETER.
3. DIMENSIONS A AND B DO NOT INCLUDE MOLD FLASH, PROTRUSIONS OR GATE BURRS. MOLD FLASH OR GATE BURRS SHALL NOT EXCEED 0.15 (0.006) PER SIDE.
4. DIMENSION K DOES NOT INCLUDE DAMBAR PROTRUSION. ALLOWABLE DAMBAR PROTRUSION SHALL BE 0.08 (0.003) TOTAL IN EXCESS OF THE K DIMENSION AT MAXIMUM MATERIAL CONDITION.
5. TERMINAL NUMBERS ARE SHOWN FOR REFERENCE ONLY.
6. DIMENSIONS A AND B ARE TO BE DETERMINED AT DATUM PLANE -W-.

DIM	MILLIMETERS		INCHES	
	MIN	MAX	MIN	MAX
A	12.40	12.60	0.488	0.496
B	6.00	6.20	0.236	0.244
C	---	1.10	---	0.043
D	0.05	0.15	0.002	0.006
F	0.50	0.75	0.020	0.030
G	0.50 BSC		0.0197 BSC	
H	0.37	---	0.015	---
J	0.09	0.20	0.004	0.008
J1	0.09	0.16	0.004	0.006
K	0.17	0.27	0.007	0.011
K1	0.17	0.23	0.007	0.009
L	7.95	8.25	0.313	0.325
M	0 °	8 °	0 °	8 °

ON Semiconductor and are trademarks of Semiconductor Components Industries, LLC (SCILLC). SCILLC reserves the right to make changes without further notice to any products herein. SCILLC makes no warranty, representation or guarantee regarding the suitability of its products for any particular purpose, nor does SCILLC assume any liability arising out of the application or use of any product or circuit, and specifically disclaims any and all liability, including without limitation special, consequential or incidental damages. "Typical" parameters which may be provided in SCILLC data sheets and/or specifications can and do vary in different applications and actual performance may vary over time. All operating parameters, including "Typicals" must be validated for each customer application by customer's technical experts. SCILLC does not convey any license under its patent rights nor the rights of others. SCILLC products are not designed, intended, or authorized for use as components in systems intended for surgical implant into the body, or other applications intended to support or sustain life, or for any other application in which the failure of the SCILLC product could create a situation where personal injury or death may occur. Should Buyer purchase or use SCILLC products for any such unintended or unauthorized application, Buyer shall indemnify and hold SCILLC and its officers, employees, subsidiaries, affiliates, and distributors harmless against all claims, costs, damages, and expenses, and reasonable attorney fees arising out of, directly or indirectly, any claim of personal injury or death associated with such unintended or unauthorized use, even if such claim alleges that SCILLC was negligent regarding the design or manufacture of the part. SCILLC is an Equal Opportunity/Affirmative Action Employer.

PUBLICATION ORDERING INFORMATION

NORTH AMERICA Literature Fulfillment:

Literature Distribution Center for ON Semiconductor
P.O. Box 5163, Denver, Colorado 80217 USA
Phone: 303-675-2175 or 800-344-3860 Toll Free USA/Canada
Fax: 303-675-2176 or 800-344-3867 Toll Free USA/Canada
Email: ONlit@hibbertco.com
Fax Response Line: 303-675-2167 or 800-344-3810 Toll Free USA/Canada

N. American Technical Support: 800-282-9855 Toll Free USA/Canada

EUROPE: LDC for ON Semiconductor – European Support

German Phone: (+1) 303-308-7140 (Mon-Fri 2:30pm to 7:00pm CET)
Email: ONlit-german@hibbertco.com
French Phone: (+1) 303-308-7141 (Mon-Fri 2:00pm to 7:00pm CET)
Email: ONlit-french@hibbertco.com
English Phone: (+1) 303-308-7142 (Mon-Fri 12:00pm to 5:00pm GMT)
Email: ONlit@hibbertco.com

EUROPEAN TOLL-FREE ACCESS*: 00-800-4422-3781

*Available from Germany, France, Italy, UK, Ireland

CENTRAL/SOUTH AMERICA:

Spanish Phone: 303-308-7143 (Mon-Fri 8:00am to 5:00pm MST)
Email: ONlit-spanish@hibbertco.com
Toll-Free from Mexico: Dial 01-800-288-2872 for Access – then Dial 866-297-9322

ASIA/PACIFIC: LDC for ON Semiconductor – Asia Support

Phone: 303-675-2121 (Tue-Fri 9:00am to 1:00pm, Hong Kong Time)
Toll Free from Hong Kong & Singapore:
001-800-4422-3781
Email: ONlit-asia@hibbertco.com

JAPAN: ON Semiconductor, Japan Customer Focus Center

4-32-1 Nishi-Gotanda, Shinagawa-ku, Tokyo, Japan 141-0031
Phone: 81-3-5740-2700
Email: r14525@onsemi.com

ON Semiconductor Website: <http://onsemi.com>

For additional information, please contact your local Sales Representative.