

DC-2.8 GHz InGaP HBT 0.5W Medium Power Amplifier

Features

- ✕ 18 dBm Linear Power @ 2140 MHz
- ✕ 15.5 dB Gain @ 2140 MHz
- ✕ 12 dB Gain @ 2700 MHz
- ✕ 27 dBm P1dB @ 2140 MHz
- ✕ Low Performance Variation Over Temperature
- ✕ Low Cost: SOT-89 Package
- ✕ 100% DC On-Wafer Testing
- ✕ ESD Protection on All Die: >4000V HBM
- ✕ Low Thermal Resistance: <35°C/Watt
- ✕ Low Volt Supply: 5V, Active Bias

Description

The CGB8001-SC is a single stage, medium power, high dynamic range amplifier. Designed for applications operating within the DC to 2.8 GHz frequency range, Mimix's medium power amplifier is an ideal solution for transmit, receive and IF applications. This MMIC amplifier is available in an industry standard, RoHS compliant, SOT-89 package. Mimix's InGaP HBT technology and an industry low thermal resistance offers a thermally robust and reliable gain block solution. The InGaP HBT die have extra pads to enable thorough DC testing. This unique test capability and the inclusion of ESD protection on all die, significantly enhances the quality, reliability and ruggedness of this product. This medium power amplifier offers significant ease of use in a broad range of applications with minimum external matching elements. The combination of high gain, P1dB and high linear power at low current makes the CGB8001-SC an ideal transmit solution as a driver or output stage when used in applications including 3G, fixed wireless broadband, WLAN and WiMAX. The CGB8001-SC has an on-chip integrated active bias circuit providing stable current over temperature variations. The device is biased with a single +5V supply in a class AB mode making it efficient at back-off input power levels.

Functional Block Diagram (SOT-89)

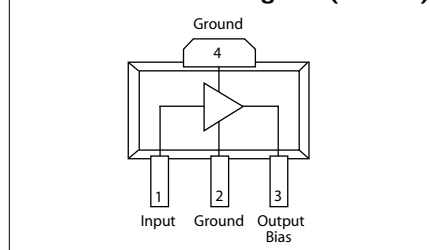

Absolute Maximum Ratings

Max Device Voltage	+6.0 V
Max Device Current	400 mA
Max Device Dissipated Power	1.2 W
RF Input Power	+17 dBm
Storage Temperature	-55°C to 150°C
Junction Temperature	150°C
Operating Temperature	-40°C to +85°C
Thermal Resistance	35° C/W
ESD (HBM)	4000 V (Class 3B)
ESD (MM)	Class C
Moisture Sensitivity Level (MSL)	MSL1

Operation of this device above any of these parameters may cause permanent damage.

Applications

- ✕ PA Driver Amp, IF Amp, LO Buffer Amp
- ✕ UMTS, 3G, WLAN, WiMAX
- ✕ Wireless Broadband, Fixed Wireless, SATCOM
- ✕ Transmit and Receive Functions
- ✕ CATV

Typical Performance: (5V, 25°C)

Parameter	Symbol	Unit	900	1950	2140	2500	2700
Frequency	F	GHz					
Small Signal Gain	S21	dB	20.5	16.2	15.5	13.5	12
Output Power at 1dB Compression	P1dB	dBm	27.6	27	27	26.5	25.2
Noise Figure	NF	dB	3.6	3.7	3.9	4.3	5.5
Pout @ ACPR = -45dBc, IS-95, 9 Forward Channels	Pout	dBm	21	21	18	16	16

*IS-95, 9 forward channels @ 900 & 1950 MHz, WCDMA, TM-1, 64 DPCH @ 2140, 2450 & 2750 MHz

Electrical Characteristics: (5V, 25°C)

Parameter	Symbol	Unit	Min	Typ	Max
Frequency	F	GHz	DC		2.8
Test Frequency	F	GHz		1.9	
Quiescent Current	Icq	mA		100	130
Small Signal Gain	S21	dB	14.5	15.7	
Output Power at 1dB Compression	P1dB	dBm	26.5	27.3	
Noise Figure	NF	dB		3.7	
Pout @ ACPR = -45dBc, IS-95, 9 Forward Channels	Pout	dBm		21	

DC-2.8 GHz InGaP HBT 0.5W Medium Power Amplifier

Evaluation Board Layout

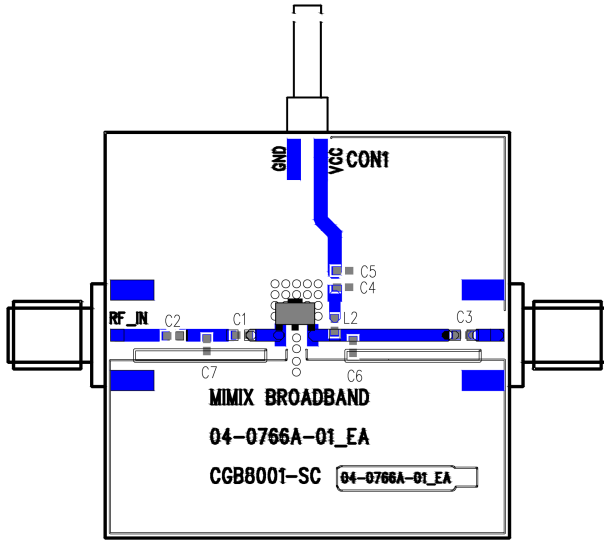

20 mil Rogers 4003, 1 Oz copper, both sides

Component Values

Component Designator	850-950 MHz (A)	1800-2200 MHz (B)	2400-2800 MHz (C)	Vendor, Size
C1	short	2.2 pF*	27 pF	KOA 0603 NPO
C2	100 pF	short	short	KOA 0603 NPO
C3	100 pF	100 pF	100 pF	KOA 0603 NPO
C4	1000 pF	1000 pF	1000 pF	KOA 0603 NPO
C5	1 uF	1 uF	1 uF	KOA 0805 X7R
C6	3.9 pF	1 pF	1 pF	KOA 0603 NPO
C7	5.5 pF	DNP	DNP	KOA 0603 NPO
L2	39 nH	27 nH	22 nH	Murata 0603 chip
TL1	6 mm, 50 ohms	N/A	N/A	N/A
TL2	3 mm, 50 ohms	3 mm, 50 ohms	3 mm, 50 ohms	N/A
TL3	1.5 mm, 50 ohms	1.5 mm, 50 ohms	1.5 mm, 50 ohms	N/A
TL4	3.5 mm, 50 ohms	3.5 mm, 50 ohms	3.5 mm, 50 ohms	N/A

* 1800-2200 MHz linearity can be improved by moving C1 3 mm further away from the CGB8001-SC

Recommended Schematic

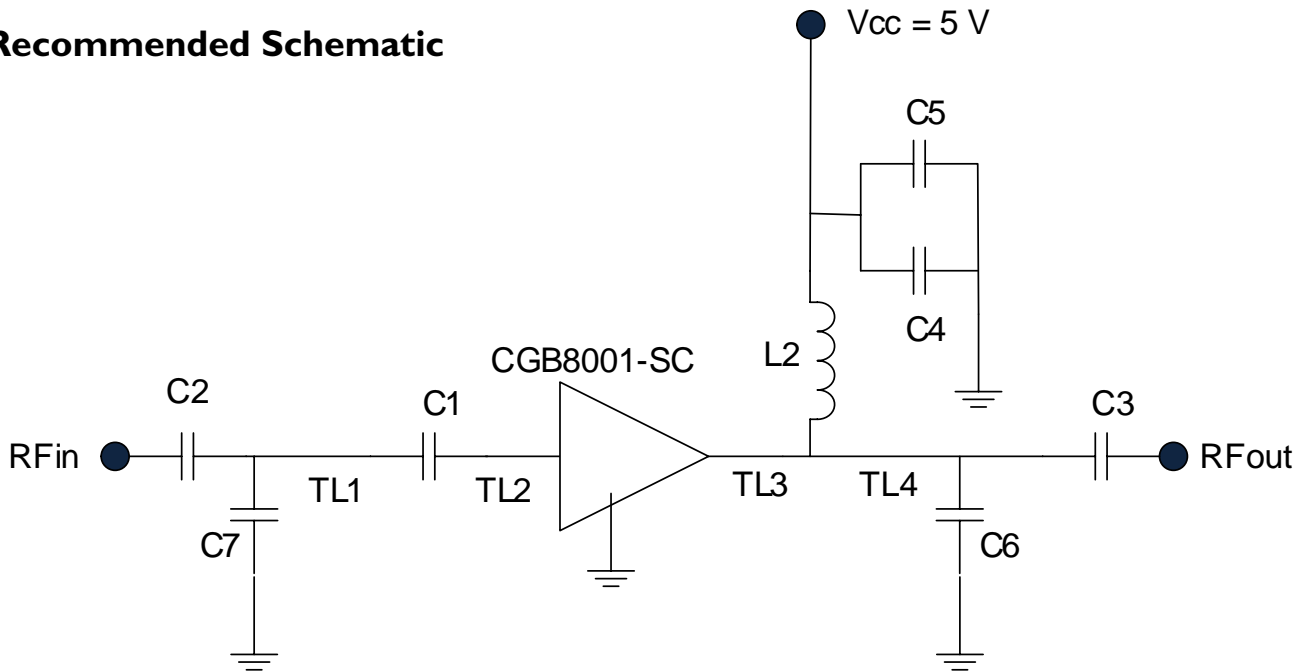

DC-2.8 GHz InGaP HBT 0.5W Medium Power Amplifier



October 2008 - Rev 06-Oct-08

CGB800I-SC
RoHS

Typical S-Parameter and Noise Performance: 900 MHz

900MHz	-40	25	85	Unit
Gain	20.3	20.5	20.1	dB
PI dB	28.0	27.6	26.1	dBm
NF	3.1	3.7	4.4	dB

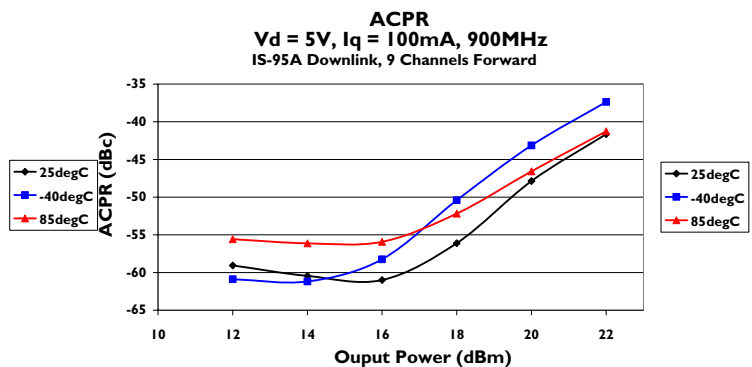
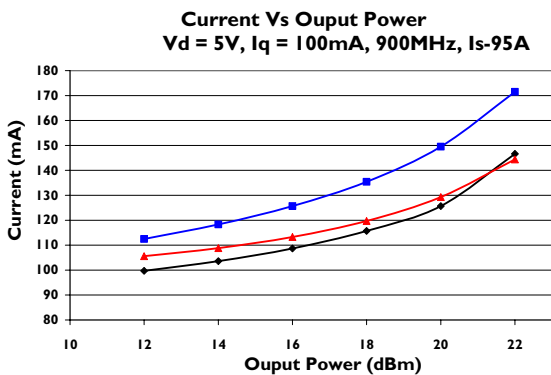
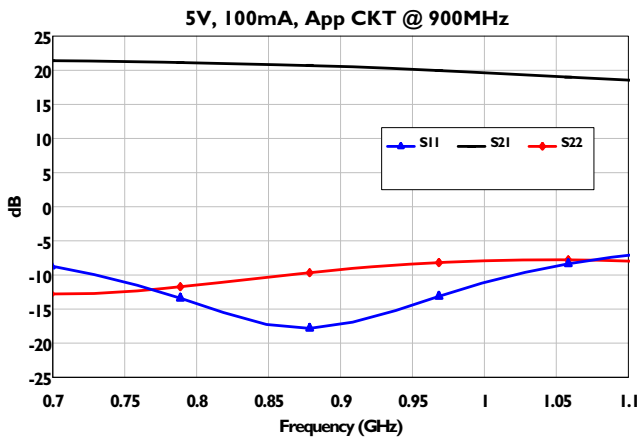
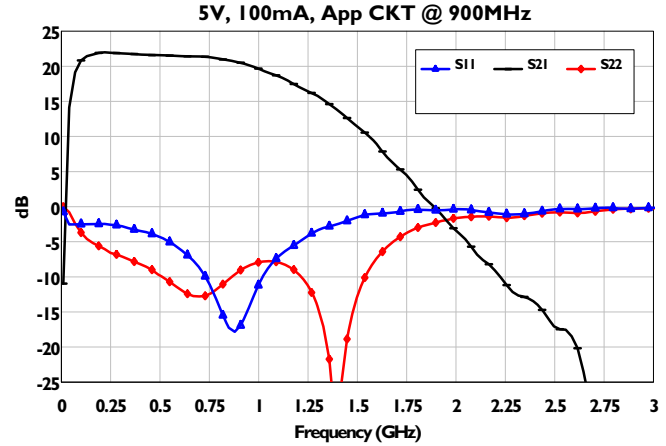

DC-2.8 GHz InGaP HBT 0.5W Medium Power Amplifier



October 2008 - Rev 06-Oct-08

CGB800I-SC
RoHS

Typical S-Parameter and Noise Performance: 1.96 GHz

1.96GHz	-40	25	85	Unit
Gain	16.4	16.2	15.9	dB
PI dB	27.8	27.2	26.8	dBm
NF	3.1	3.7	4.3	dB

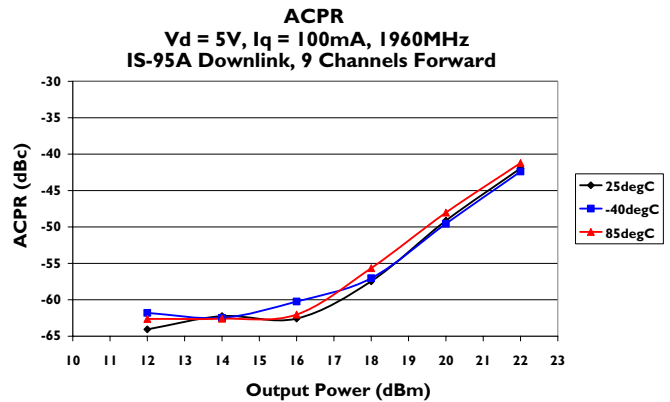
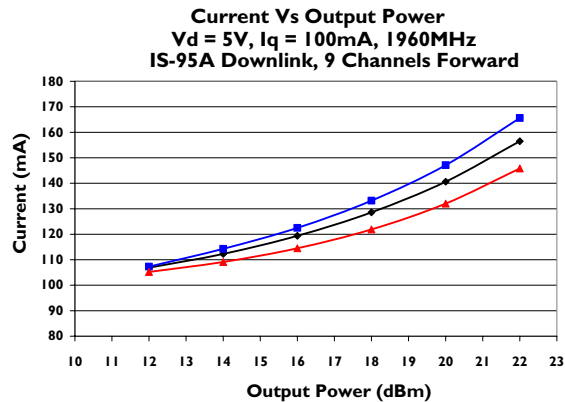
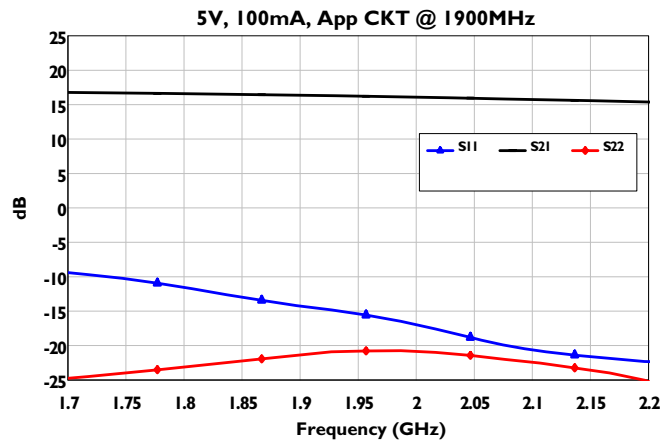
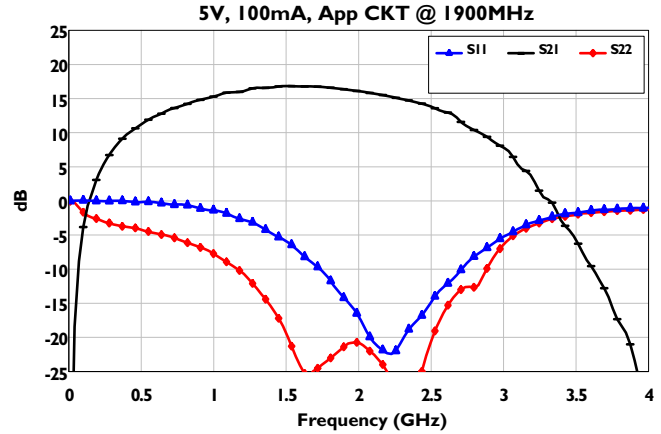

DC-2.8 GHz InGaP HBT 0.5W Medium Power Amplifier



October 2008 - Rev 06-Oct-08

CGB800I-SC
RoHS

Typical S-Parameter and Noise Performance: 2.14 GHz

2.14GHz	-40	25	85	Unit
Gain	15.8	15.5	14.9	dB
PI dB	28.2	27.0	26.7	dBm
NF	3.3	3.9	4.7	dB

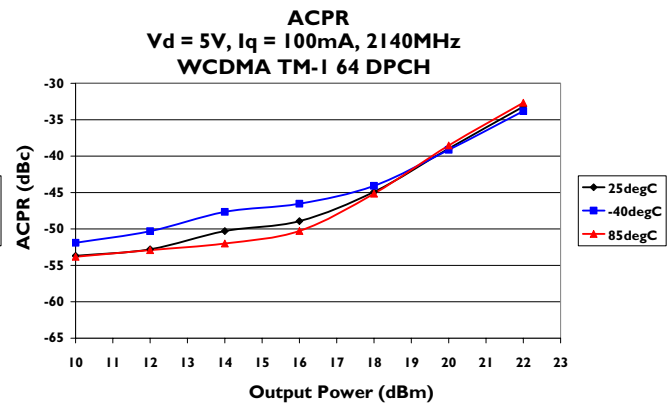
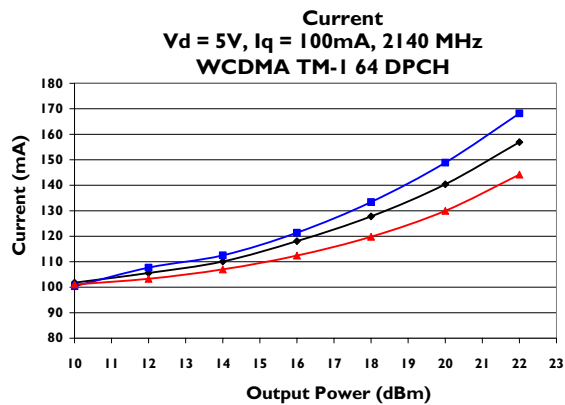
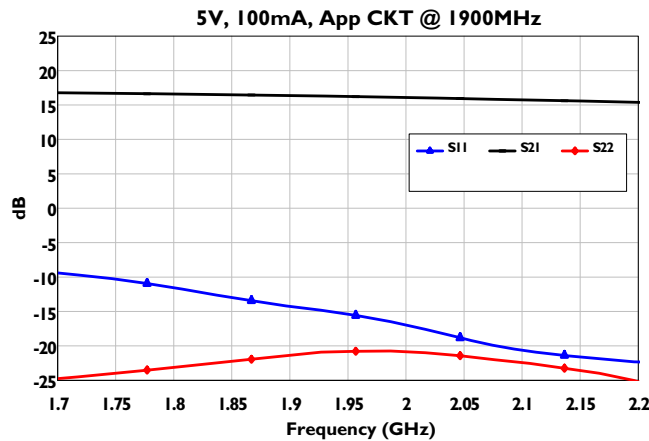
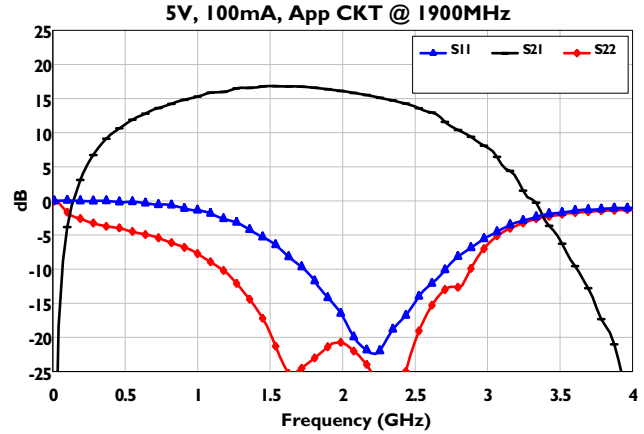

DC-2.8 GHz InGaP HBT 0.5W Medium Power Amplifier



October 2008 - Rev 06-Oct-08

CGB800I-SC
RoHS

Typical S-Parameter and Noise Performance: 2.45 GHz

2.45GHz	-40	25	85	Unit
Gain	14.0	13.7	12.8	dB
PI dB	26.8	26.6	26.2	dBm
NF	3.8	4.1	4.9	dB

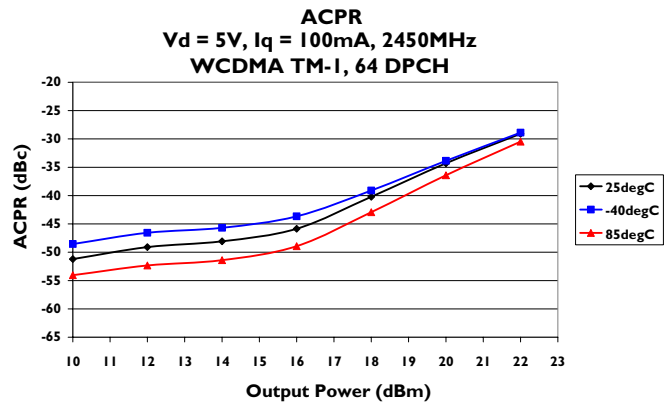
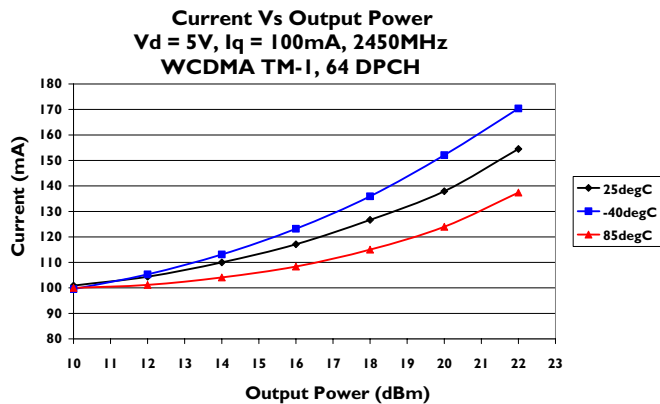
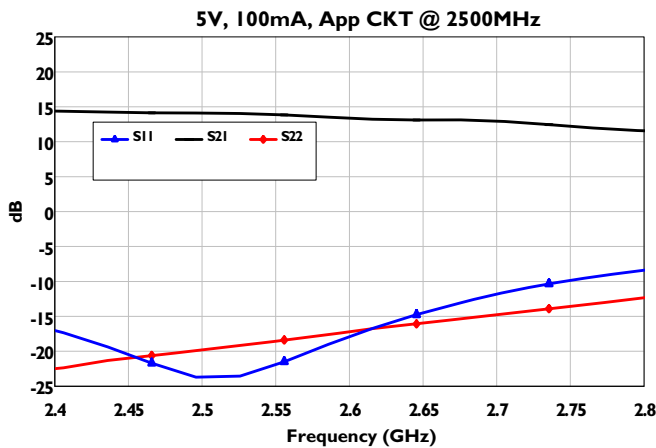
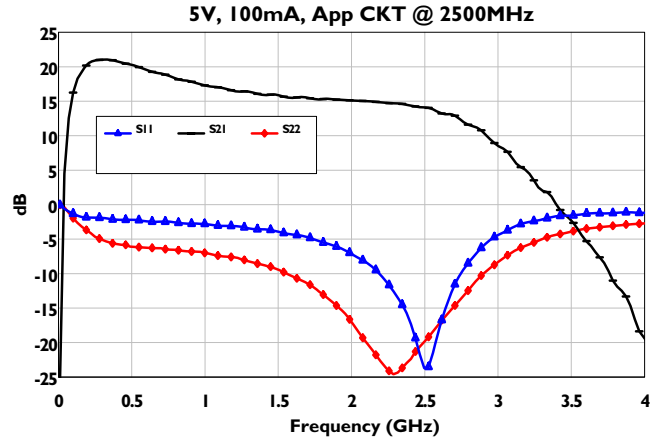

DC-2.8 GHz InGaP HBT 0.5W Medium Power Amplifier



October 2008 - Rev 06-Oct-08

CGB800I-SC
RoHS

Typical S-Parameter and Noise Performance: 2.75 GHz

2.75GHz	-40	25	85	Unit
Gain	12.3	11.9	11.0	dB
PI dB	25.4	25.2	24.8	dBm
NF	4.7	5.5	7.5	dB

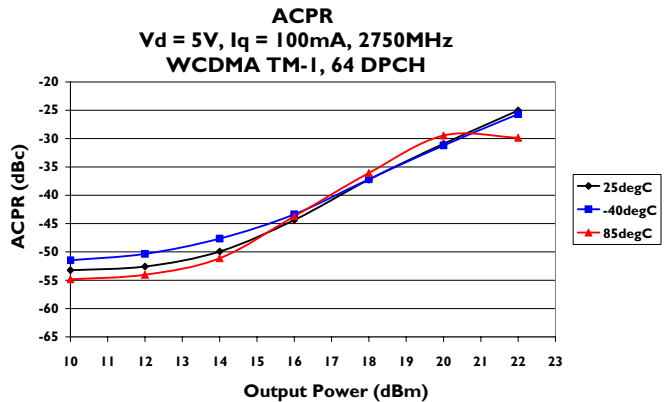
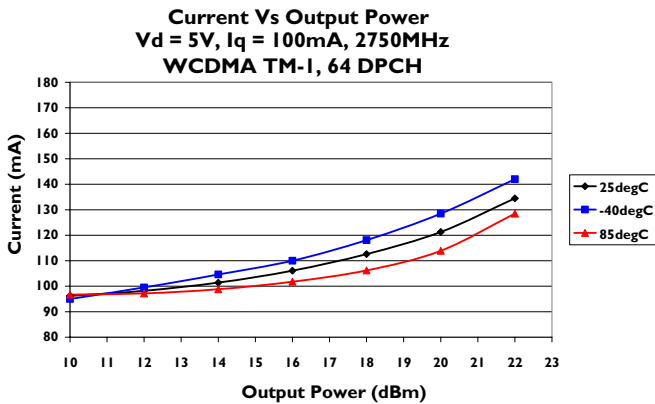
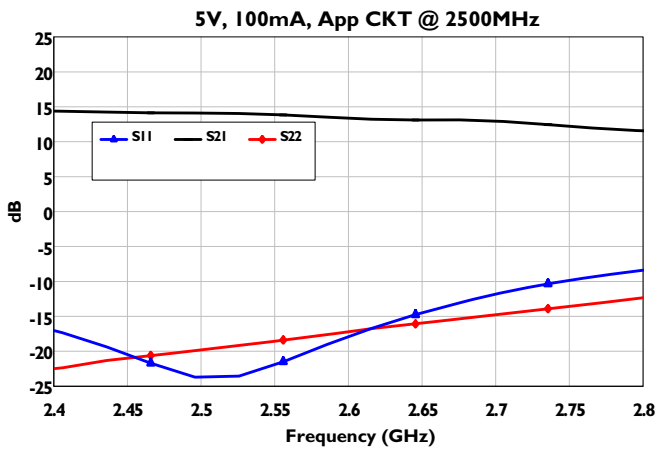
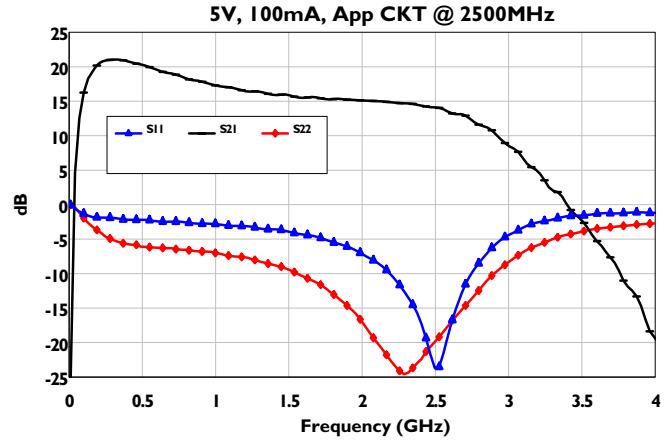

DC-2.8 GHz InGaP HBT 0.5W Medium Power Amplifier

October 2008 - Rev 06-Oct-08

MTTF

These numbers were calculated based on accelerated life test information received from the fabrication foundry and measured thermal resistance.

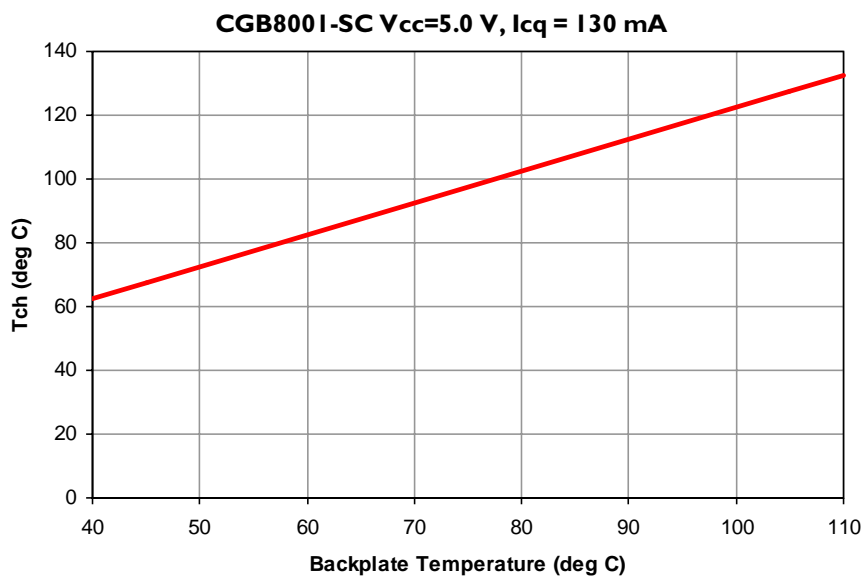
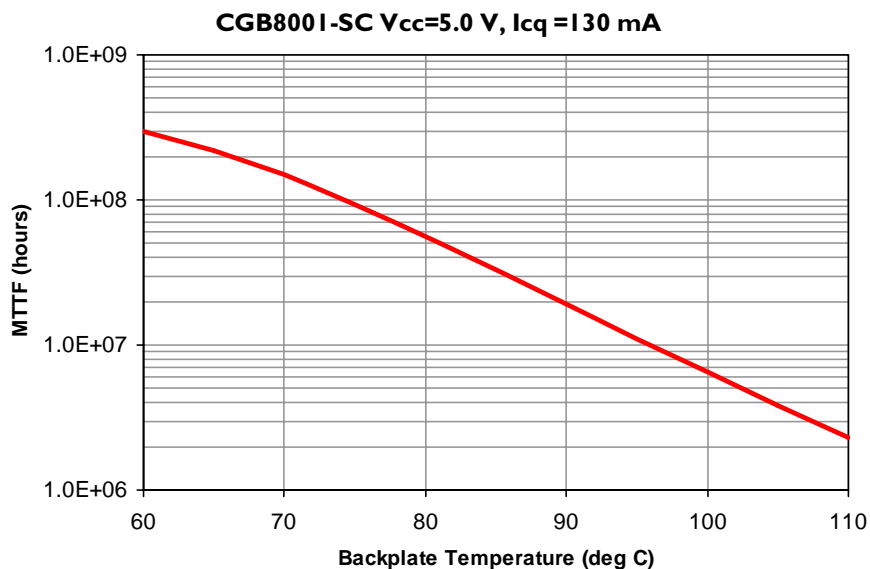

DC-2.8 GHz InGaP HBT 0.5W Medium Power Amplifier

October 2008 - Rev 06-Oct-08

Handling and Assembly Information

CAUTION! - Mimix Broadband MMIC Products contain gallium arsenide (GaAs) which can be hazardous to the human body and the environment. For safety, observe the following procedures:

- Do not ingest.
- Do not alter the form of this product into a gas, powder, or liquid through burning, crushing, or chemical processing as these by-products are dangerous to the human body if inhaled, ingested, or swallowed.
- Observe government laws and company regulations when discarding this product. This product must be discarded in accordance with methods specified by applicable hazardous waste procedures.

Life Support Policy - Mimix Broadband's products are not authorized for use as critical components in life support devices or systems without the express written approval of the President and General Counsel of Mimix Broadband. As used herein: (1) Life support devices or systems are devices or systems which, (a) are intended for surgical implant into the body, or (b) support or sustain life, and whose failure to perform when properly used in accordance with instructions for use provided in the labeling, can be reasonably expected to result in a significant injury to the user. (2) A critical component is any component of a life support device or system whose failure to perform can be reasonably expected to cause the failure of the life support device or system, or to affect its safety or effectiveness.

Package Attachment - This packaged product from Mimix Broadband is provided as a rugged surface mount package compatible with high volume solder installation. Care should be taken not to apply heavy pressure to the top or base material to avoid package damage. Vacuum tools or other suitable pick and place equipment may be used to pick and place this part. Care should be taken to ensure that there are no voids or gaps in the solder connection so that good RF, DC and ground connections are maintained. Voids or gaps can eventually lead not only to RF performance degradation, but reduced reliability and life of the product due to thermal stress.

Mimix Lead-Free RoHS Compliant Program - Mimix has an active program in place to meet customer and governmental requirements for eliminating lead (Pb) and other environmentally hazardous materials from our products. All Mimix RoHS compliant components are form, fit and functional replacements for their non-RoHS equivalents. Lead plating of our RoHS compliant parts is 100% matte tin (Sn) over copper alloy and is backwards compatible with current standard SnPb low-temperature reflow processes as well as higher temperature (260°C reflow) "Pb Free" processes.

Ordering Information

Part Number for Ordering	Description
CGB8001-SC-0G00	Matte Tin plated RoHS compliant SOT-89 surface mount package in bulk quantity
CGB8001-SC-0G0T	Matte Tin plated RoHS compliant SOT-89 surface mount package in tape and reel
PB-CGB8001-SC-00A0	Evaluation Board for 850-950 MHz
PB-CGB8001-SC-00B0	Evaluation Board for 1800-2200 MHz
PB-CGB8001-SC-00C0	Evaluation Board for 2400-2800 MHz

We also offer the plastic packages with SnPb (Tin-Lead) or NiPdAu plating. Please contact your regional sales manager for more information regarding different plating types



Proper ESD procedures should be followed when handling this device.

Mimix Broadband, Inc., 10795 Rockley Rd., Houston, Texas 77099
Tel: 281.988.4600 Fax: 281.988.4615 mimixbroadband.com

Page 9 of 9