

<b>AsahiKASEI</b> ASAHI KASEI EMD	<b>AKD4104-A</b> <b>AK4104 Evaluation Board Rev.0</b>
--------------------------------------	--

**GENERAL DESCRIPTION**

The AKD4104-A is an evaluation board for the AK4104, 192 kHz 24-Bit 3.3V DIT. The AKD4104-A be designed for getting digital interface signals from extern instruments, it is easy to evaluate the AK4104.

■ **Ordering guide**

AKD4104-A --- AK4104 Evaluation Board

**FUNCTION**

- **Get digital interface signals form extern instruments using PORT3 (DSP)**
- **Optical output for internal DIT**

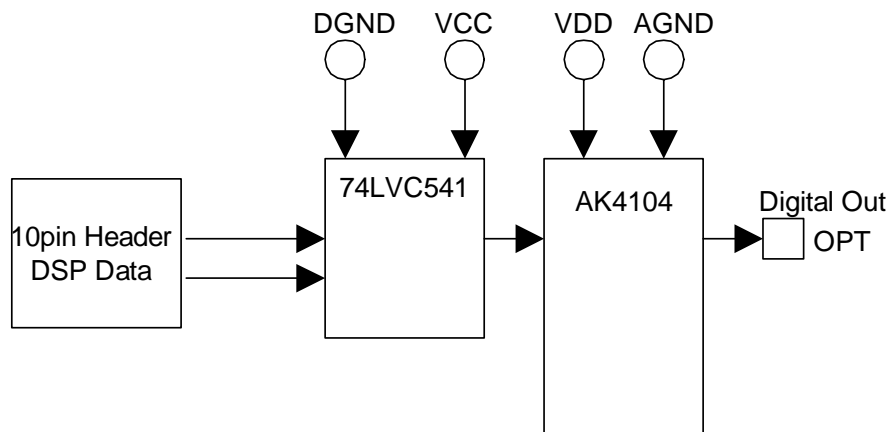

Figure 1. AKD4104-A Block Diagram

## ■ Operation sequence

### 1) Set up the power supply lines.

[VDD]	(Red)	= 2.7 ~ 3.6V (typ. 3.3V, for AK4104)
[VCC]	(Red)	= 2.7 ~ 3.6V (typ. 3.3V, for 74LVC541 and for logic)
[AGND]	(Black)	= 0V
[DGND]	(Black)	= 0V

Each supply line should be distributed from the power supply unit.

### 2) Set-up the evaluation modes, jumper pins (See the followings.)

### 3) Power on.

AK4104 should be reset once by bringing SW1 "L" upon power-down.

AK4104 can power-up when bringing SW1 "H".

## ■ Evaluation mode

D/D part evaluation using PORT3 (DSP), and supplying all interface signals from external equipments  
In case of using PORT3 (DSP), and supplying signals (MCLK, BICK, LRCK, SDTI) that is needed for the AK4104 from external equipments, set up jumper pins as following.

- ① JP2 (CDTO / SDTI2) : CDTO / SDTI2 pins
  - CDTO: CDTO be selected. <Default>
  - SDTI2: SDTI2 be selected.
  
- ③ JP3 (SDTI2) : TEST1 pin
  - VDD: shorted with GND. <Default>
  - GND: shorted with GND.
  
- ③ JP15 (VDD) : VDD and VCC can be shorted
  - OPEN: Separate VDD and VCC.
  - SHORT: Short VDD and VCC. <Default>
  
- ④ JP16 (GND) : AGND and DGND can be shorted
  - OPEN: Separate AGND and DGND.
  - SHORT: Short AGND and DGND. <Default>

■ **The function of the toggle SW**

[SW1] (AK4104-PDN): Resets the AK4104. Keep “H” during normal operation.  
 The AK4104 should be reset once by bringing SW1 “L” upon power-up.

■ **Serial control**

The AKD4104-A can be controlled via the printer port (parallel port) of IBM-AT compatible PC. Connect PORT4 (uP-I/F) to PC by 10-line flat cable packed with the AKD4104-A. Take care of the direction of connector. There is a mark at pin#1. The pin layout of PORT4 as shown Figure 3.

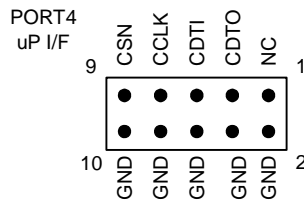

Figure 3. PORT4 pin layout

## Control Software Manual

### ■ Set-up of evaluation board and control software

1. Set up the AKD4104-A according to the **Operating Sequence** located on page 2.
2. Connect IBM-AT compatible PC with AKD4104-A by 10-line type flat cable (packed with AKD4104-A). Take care of the direction of 10pin header. (Please install the driver in the CD-ROM when this control software is used on Windows 2000/XP. Please refer “Installation Manual of Control Software Driver by AKM device control software”. In case of Windows95/98/ME, this installation is not needed. This control software does not operate on Windows NT.)
3. Insert the CD-ROM labeled “AKD4104-A Evaluation Kit” into the CD-ROM drive.
4. Access the CD-ROM drive and double-click the icon of “akd4104-a.exe” to set up the control program.
5. Please evaluate according to the following.

### ■ Operation flow

Keep the following flow.

1. Set up the control program according to explanation above.
2. Click “Port Reset” button.

### ■ Explanation of each buttons

1. [Port Reset]: Set up the USB interface board (AKDUSBIF-A) .
2. [Write default]: Initialize the register of AK4104.
3. [All Write]: Write all registers that is currently displayed.
4. [Function1]: Dialog to write data by keyboard operation.
5. [Function2]: Dialog to write data by keyboard operation.
6. [Function3]: The sequence of register setting can be set and executed.
7. [Function4]: The sequence that is created on [Function3] can be assigned to buttons and executed.
8. [Function5]: The register setting that is created by [SAVE] function on main window can be assigned to buttons and executed.
9. [SAVE]: Save the current register setting.
10. [OPEN]: Write the saved values to all register.
11. [Write]: Dialog to write data by mouse operation.

### ■ Indication of data

Input data is indicated on the register map. Red letter indicates “H” or “1” and blue one indicates “L” or “0”. Blank is the part that is not defined in the datasheet.

## ■ Explanation of each dialog

### 1. [Write Dialog]: Dialog to write data by mouse operation

There are dialogs corresponding to each register.

Click the [Write] button corresponding to each register to set up the dialog. If you check the check box, data becomes “H” or “1”. If not, “L” or “0”.

If you want to write the input data to AK4104, click [OK] button. If not, click [Cancel] button.

### 2. [Function1 Dialog] : Dialog to write data by keyboard operation

Address Box: Input registers address in 2 figures of hexadecimal.

Data Box: Input registers data in 2 figures of hexadecimal.

If you want to write the input data to AK4104, click [OK] button. If not, click [Cancel] button.

### 3. [Function2 Dialog] : Dialog to evaluate ATT

Address Box: Input registers address in 2 figures of hexadecimal.

Start Data Box: Input starts data in 2 figures of hexadecimal.

End Data Box: Input end data in 2 figures of hexadecimal.

Interval Box: Data is written to AK4104 by this interval.

Step Box: Data changes by this step.

Mode Select Box:

\*If you check this check box, data reaches end data, and returns to start data.

[Example] Start Data = 00, End Data = 09

Data flow: 00 01 02 03 04 05 06 07 08 09 09 08 07 06 05 04 03 02 01 00

\*If you do not check this check box, data reaches end data, but does not return to start data.

[Example] Start Data = 00, End Data = 09

Data flow: 00 01 02 03 04 05 06 07 08 09

If you want to write the input data to AK4104, click [OK] button. If not, click [Cancel] button.



## **4. [Save] and [Open]**

### **4-1. [Save]**

Save the current register setting data. The extension of file name is “akr”.

(Operation flow)

- (1) Click [Save] Button.
- (2) Set the file name and push [Save] Button. The extension of file name is “akr”.

### **4-2. [Open]**

The register setting data saved by [Save] is written to AK4104. The file type is the same as [Save].

(Operation flow)

- (1) Click [Open] Button.
- (2) Select the file (\*.akr) and Click [Open] Button.

## 5. [Function3 Dialog]

The sequence of register setting can be set and executed.

- (1) Click [F3] Button.
- (2) Set the control sequence.  
Set the address, Data and Interval time. Set "-1" to the address of the step where the sequence should be paused.
- (3) Click [Start] button. Then this sequence is executed.

The sequence is paused at the step of Interval="-1". Click [START] button, the sequence restarts from the paused step.

This sequence can be saved and opened by [Save] and [Open] button on the Function3 window. The extension of file name is "aks".

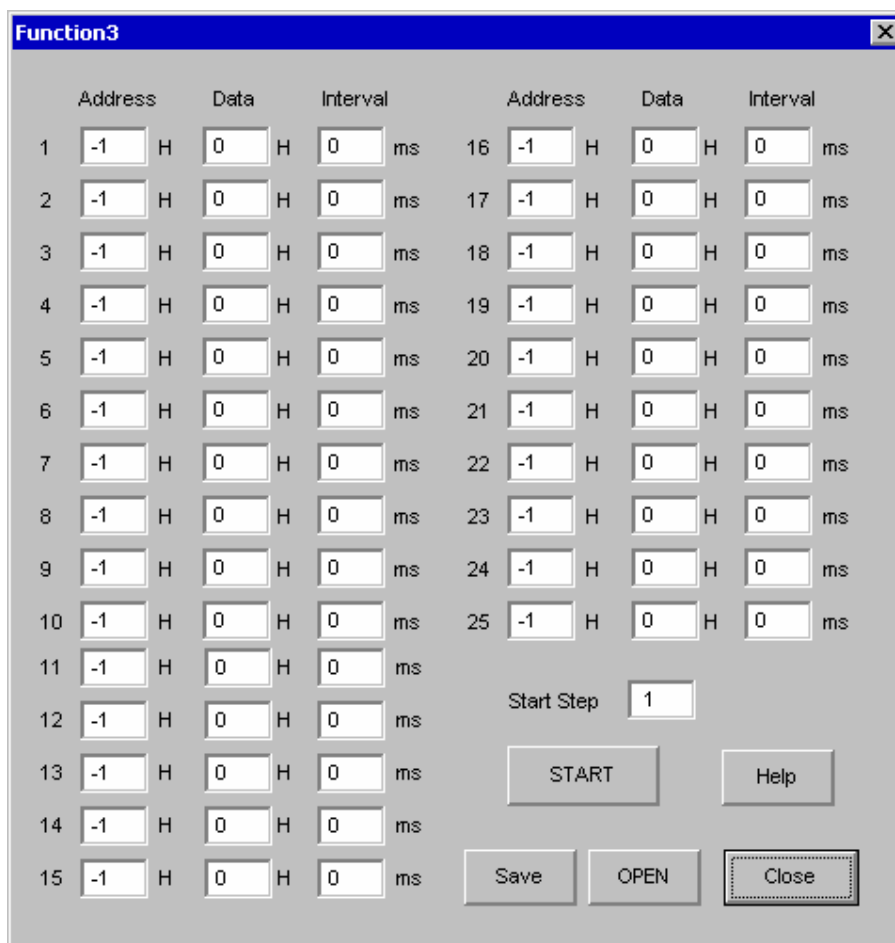

	Address	Data	Interval		Address	Data	Interval		
1	-1	H	0	ms	16	-1	H	0	ms
2	-1	H	0	ms	17	-1	H	0	ms
3	-1	H	0	ms	18	-1	H	0	ms
4	-1	H	0	ms	19	-1	H	0	ms
5	-1	H	0	ms	20	-1	H	0	ms
6	-1	H	0	ms	21	-1	H	0	ms
7	-1	H	0	ms	22	-1	H	0	ms
8	-1	H	0	ms	23	-1	H	0	ms
9	-1	H	0	ms	24	-1	H	0	ms
10	-1	H	0	ms	25	-1	H	0	ms
11	-1	H	0	ms					
12	-1	H	0	ms					
13	-1	H	0	ms					
14	-1	H	0	ms					
15	-1	H	0	ms					

Start Step

START      Help

Save      OPEN      Close

Figure 4. Window of [F3]

### 6. [Function4 Dialog]

The sequence that is created on [Function3] can be assigned to buttons and executed. When [F4] button is clicked, the window as shown in Figure5 opens.

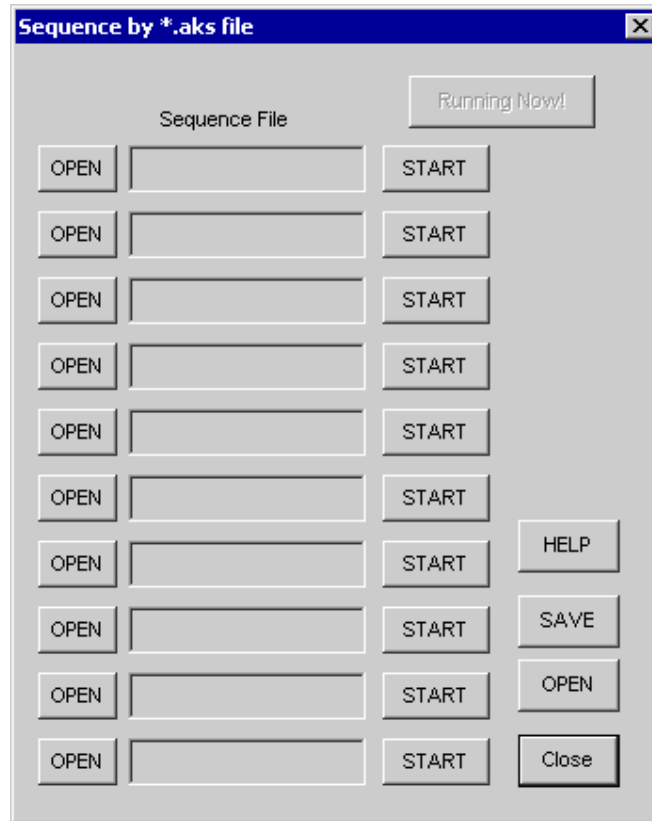

Figure 5. [F4] window



**6-1. [OPEN] buttons on left side and [START] buttons**

(1) Click [OPEN] button and select the sequence file (\*.aks).

The sequence file name is displayed as shown in Figure6.

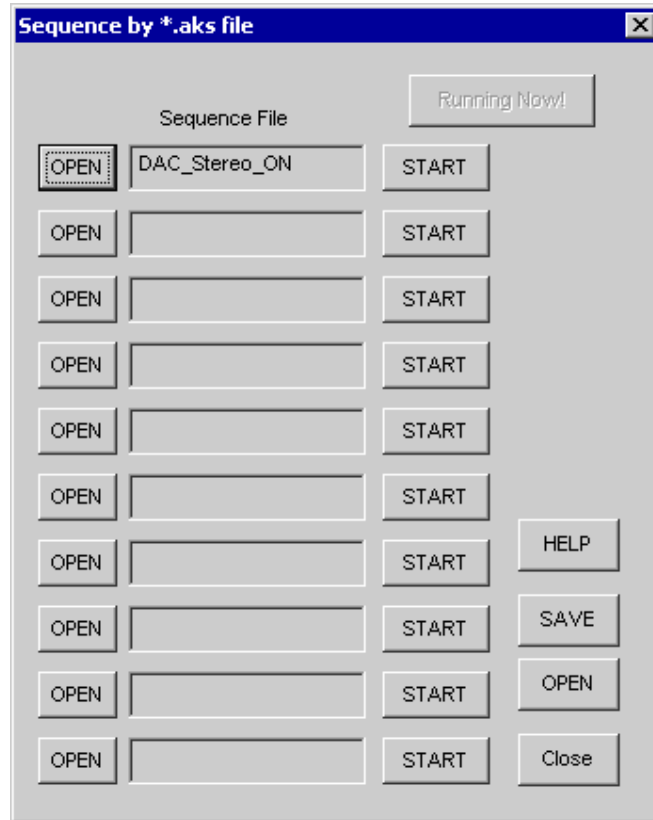

Figure 6. [F4] window(2)

(2) Click [START] button, then the sequence is executed.

**6-2. [SAVE] and [OPEN] buttons on right side**

[SAVE]: The sequence file names can assign be saved. The file name is \*.ak4.

[OPEN]: The sequence file names assign that are saved in \*.ak4 are loaded.

**6-3. Note**

- (1) This function doesn't support the pause function of sequence function.
- (2) All files need to be in same folder used by [SAVE] and [OPEN] function on right side.
- (3) When the sequence is changed in [Function3], the file should be loaded again in order to reflect the change.

## 7. [Function5 Dialog]

The register setting that is created by [SAVE] function on main window can be assigned to buttons and executed. When [F5] button is clicked, the following window as shown in Figure7 opens.

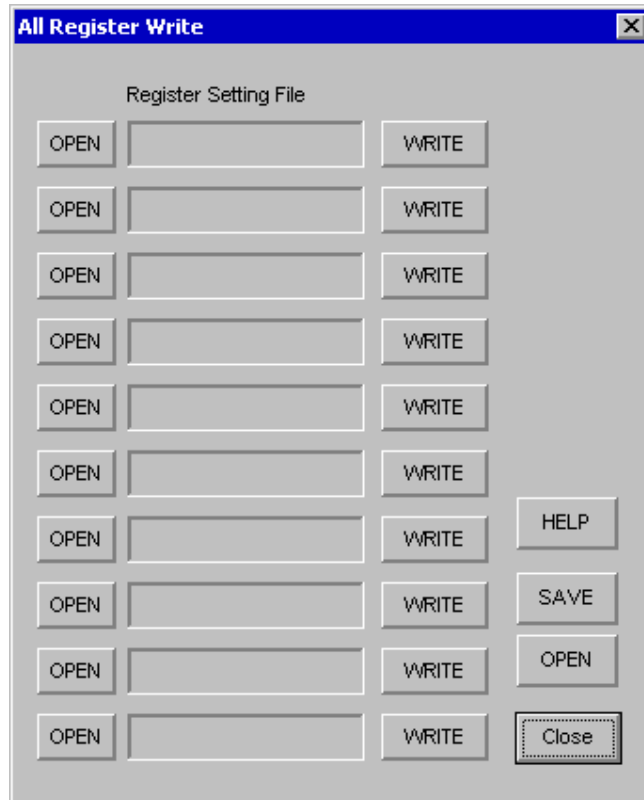

Figure 7. [F5] window

### 7-1. [OPEN] buttons on left side and [WRITE] button

- (1) Click [OPEN] button and select the register setting file (\*.akr).
- (2) Click [WRITE] button, then the register setting is executed.

### 7-2. [SAVE] and [OPEN] buttons on right side

[SAVE] : The register setting file names assign can be saved. The file name is \*.ak5.

[OPEN] : The register setting file names assign that are saved in \*.ak5 are loaded.

### 7-3. Note

- (1) All files need to be in same folder used by [SAVE] and [OPEN] function on right side.
- (3) When the register setting is changed by [Save] Button in main window, the file should be loaded again in order to reflect the change.

<b>Revision History</b>
-------------------------

Date (yy/mm/dd)	Manual Revision	Board Revision	Reason	Contents
07/07/05	KM089600	0		First Edition

— IMPORTANT NOTICE —

- These products and their specifications are subject to change without notice.  
When you consider any use or application of these products, please make inquiries the sales office of Asahi Kasei EMD Corporation (AKEMD) or authorized distributors as to current status of the products.
- AKEMD assumes no liability for infringement of any patent, intellectual property, or other rights in the application or use of any information contained herein.
- Any export of these products, or devices or systems containing them, may require an export license or other official approval under the law and regulations of the country of export pertaining to customs and tariffs, currency exchange, or strategic materials.
- AKEMD products are neither intended nor authorized for use as critical components<sup>Note1</sup> in any safety, life support, or other hazard related device or system<sup>Note2</sup>, and AKEMD assumes no responsibility for such use, except for the use approved with the express written consent by Representative Director of AKEMD. As used here:
  - Note1)** A critical component is one whose failure to function or perform may reasonably be expected to result, whether directly or indirectly, in the loss of the safety or effectiveness of the device or system containing it, and which must therefore meet very high standards of performance and reliability.
  - Note2)** A hazard related device or system is one designed or intended for life support or maintenance of safety or for applications in medicine, aerospace, nuclear energy, or other fields, in which its failure to function or perform may reasonably be expected to result in loss of life or in significant injury or damage to person or property.
- It is the responsibility of the buyer or distributor of AKEMD products, who distributes, disposes of, or otherwise places the product with a third party, to notify such third party in advance of the above content and conditions, and the buyer or distributor agrees to assume any and all responsibility and liability for and hold AKEMD harmless from any and all claims arising from the use of said product in the absence of such notification.

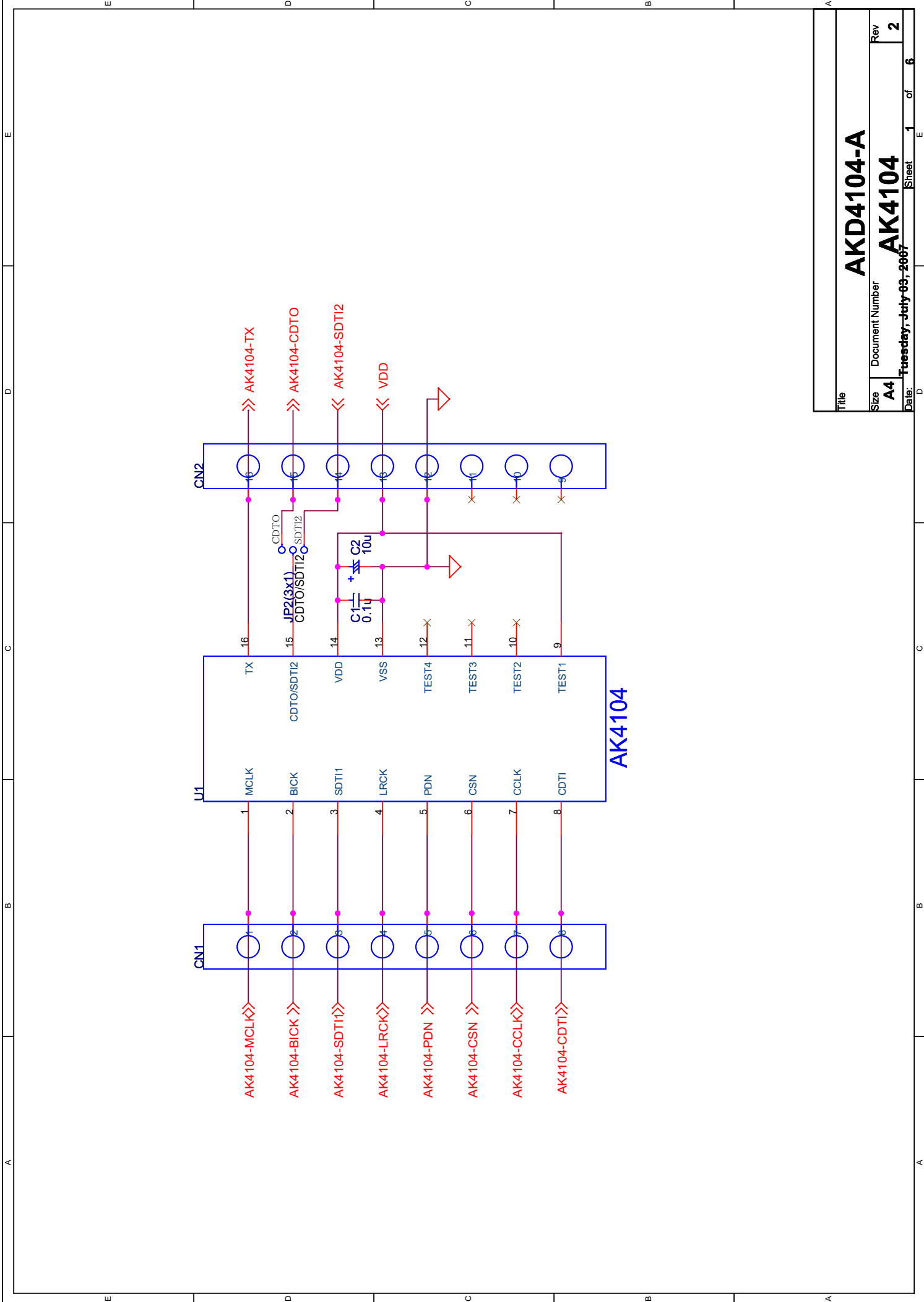

**AKD4104-A**

Title	
Size	Document Number
<b>A4</b>	<b>AK4104</b>
Date:	Rev
Tuesday, July 03, 2007	<b>2</b>
Sheet	of
1	6

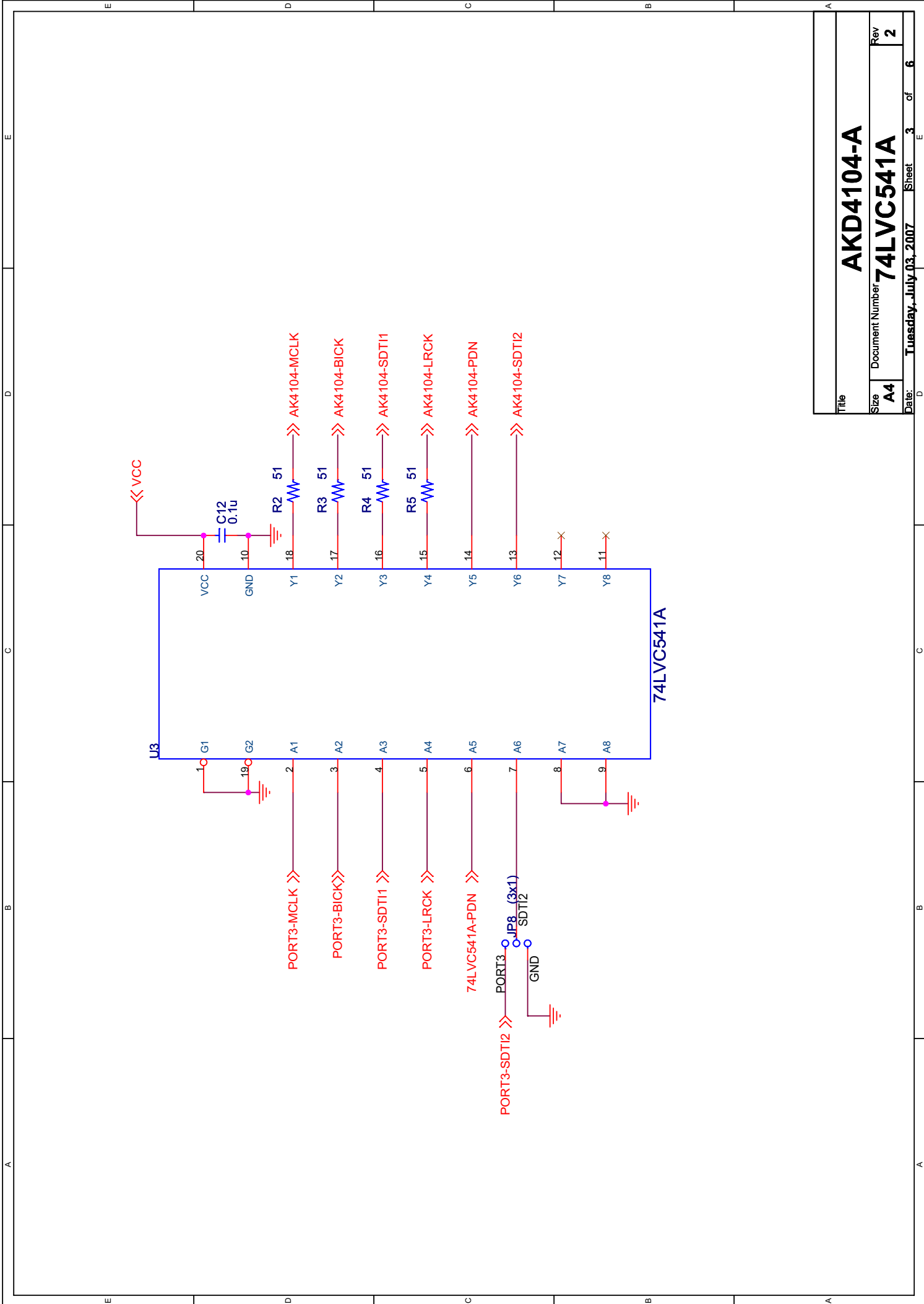

# AKD4104-A

Title: **AKD4104-A**  
 Size: **A4**  
 Document Number: **74LVC541A**  
 Date: **Tuesday, July 03, 2007**

Sheet **3** of **6**  
 Rev **2**

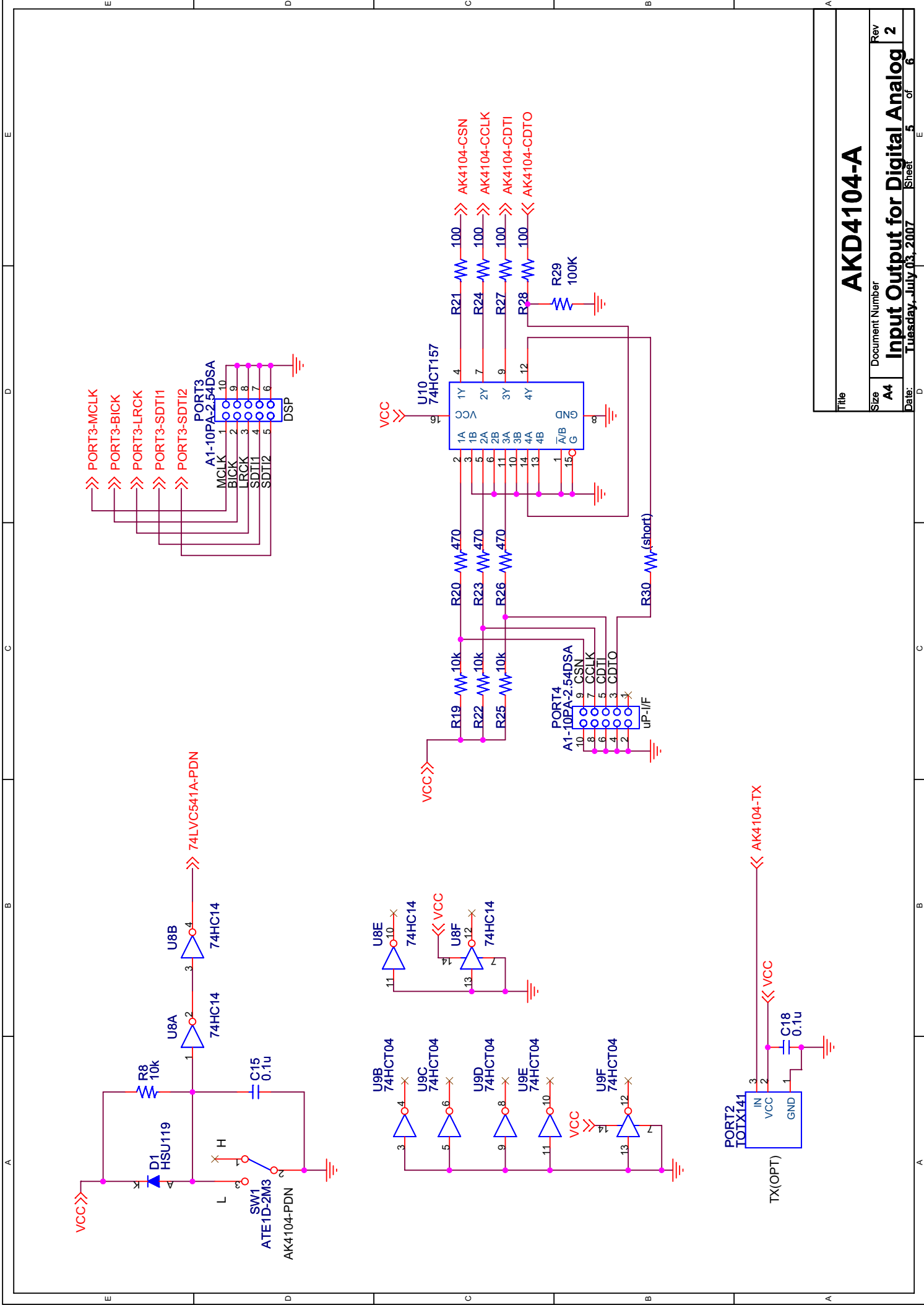

# AKD4104-A

Title		Document Number	
Size	A4	Sheet	5 of 6
Date:	Tuesday, July 03, 2007	Rev	2

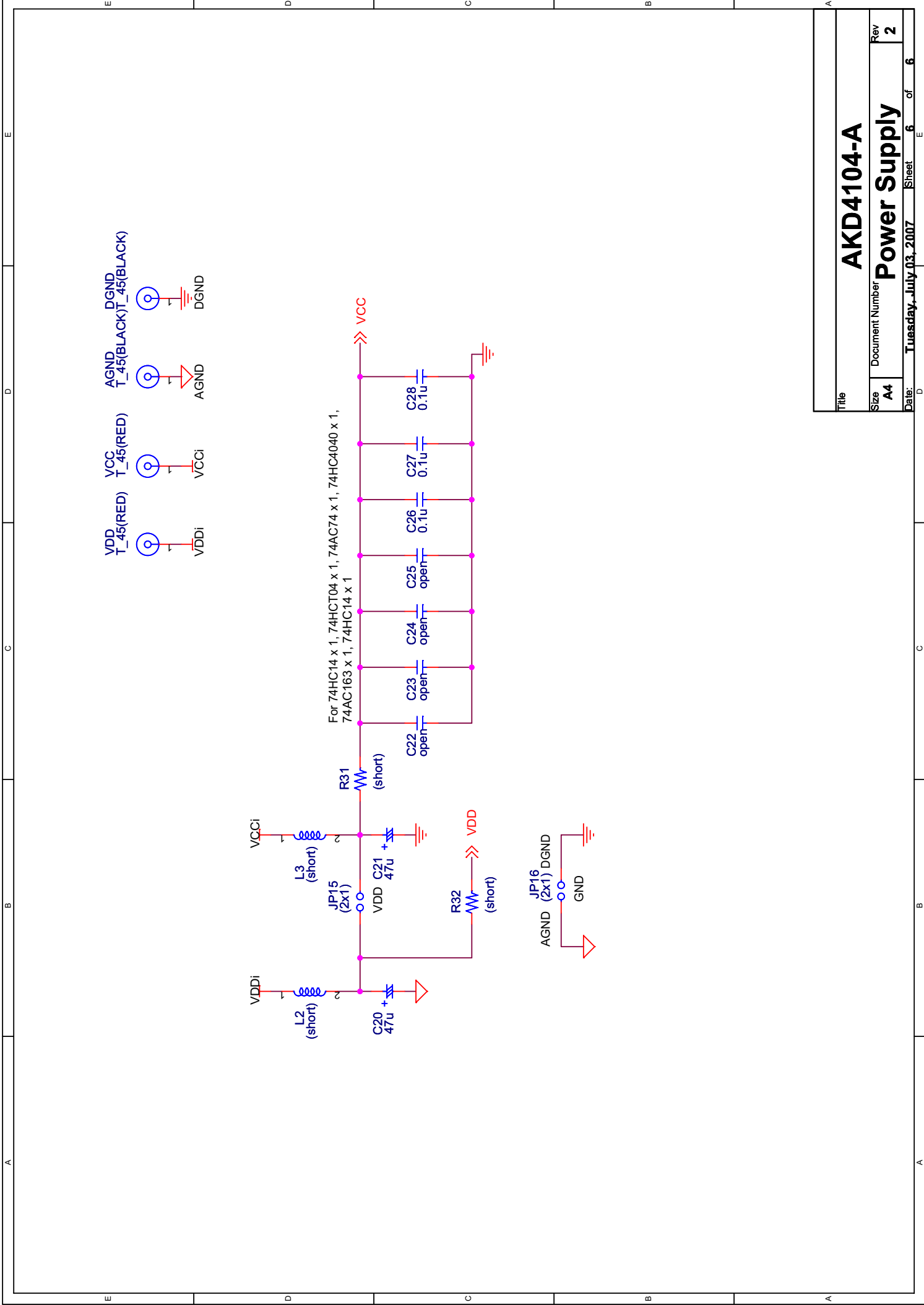

Title		<b>AKD4104-A</b>	
Size	Document Number	Sheet	Rev
<b>A4</b>	<b>Power Supply</b>	<b>6</b> of <b>6</b>	<b>2</b>
Date:		<b>Tuesday, July 03, 2007</b>	

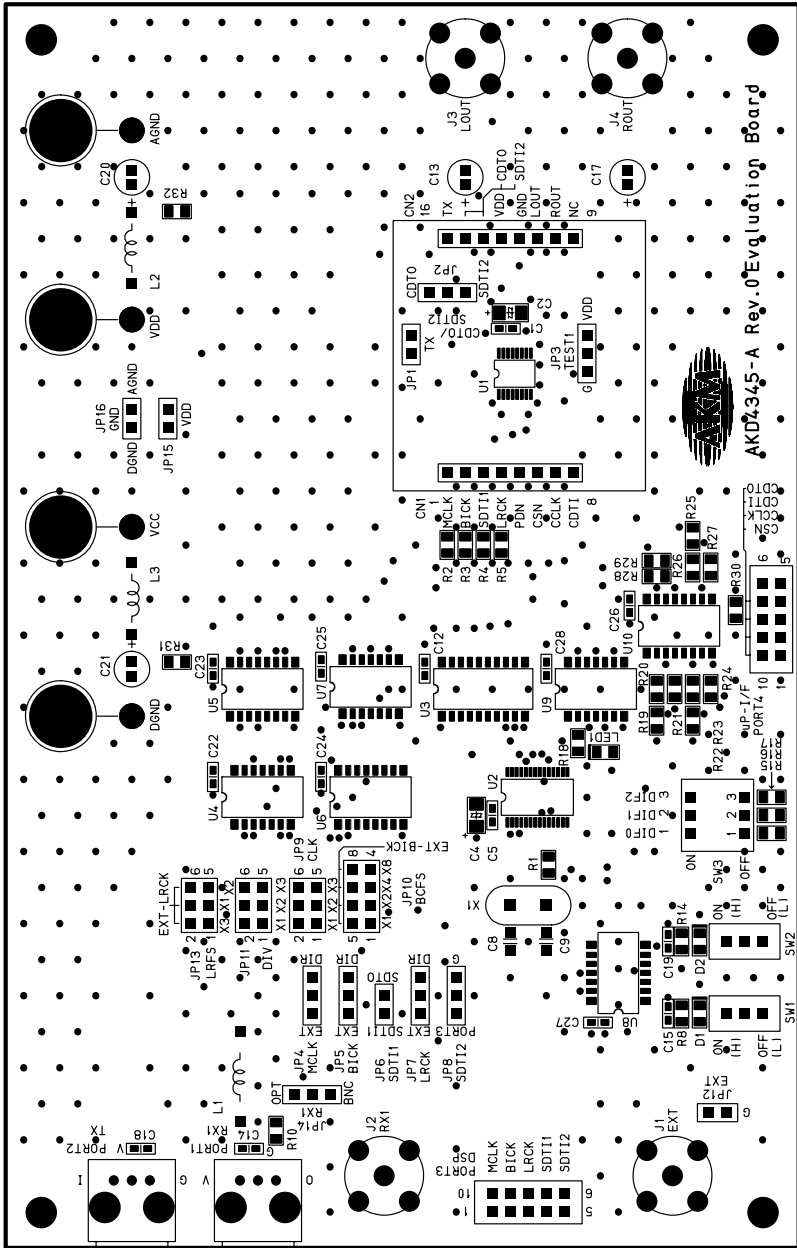

AKDx345-A L1 SILK



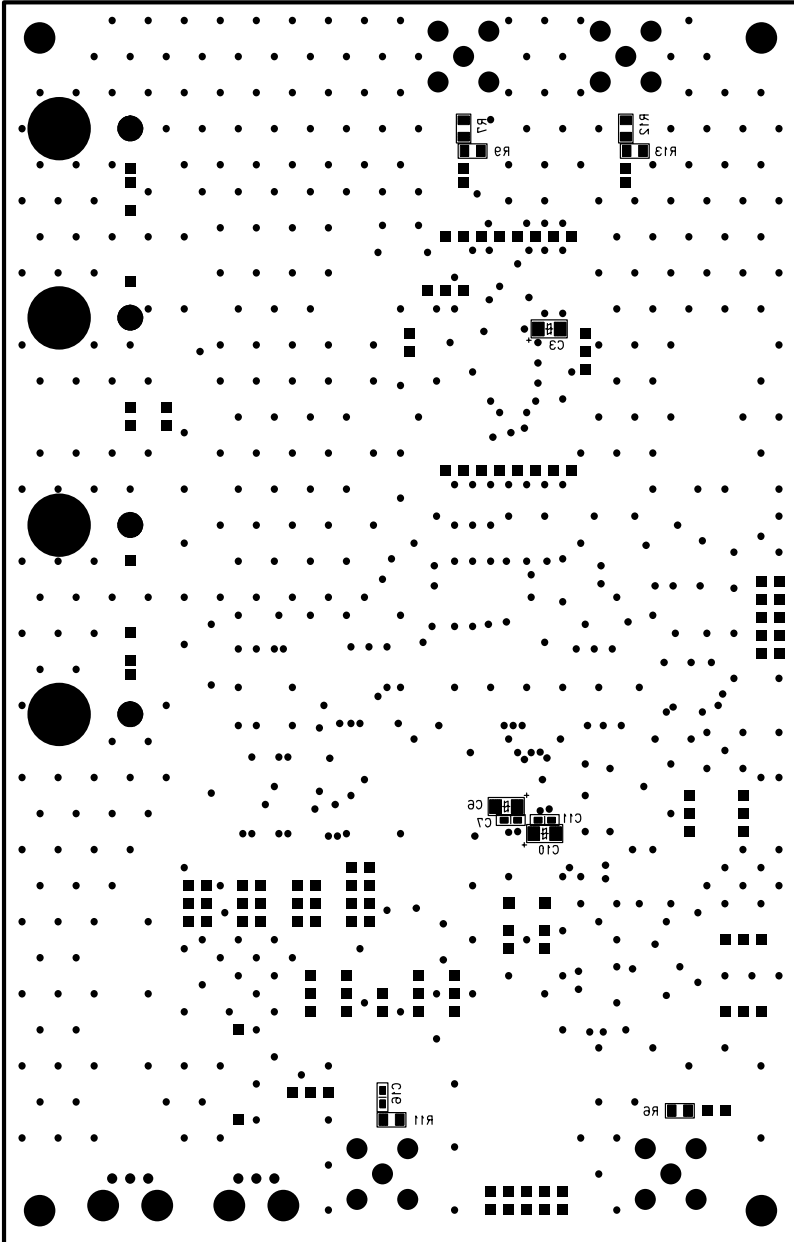

AKD3PC2-V L3 21LK

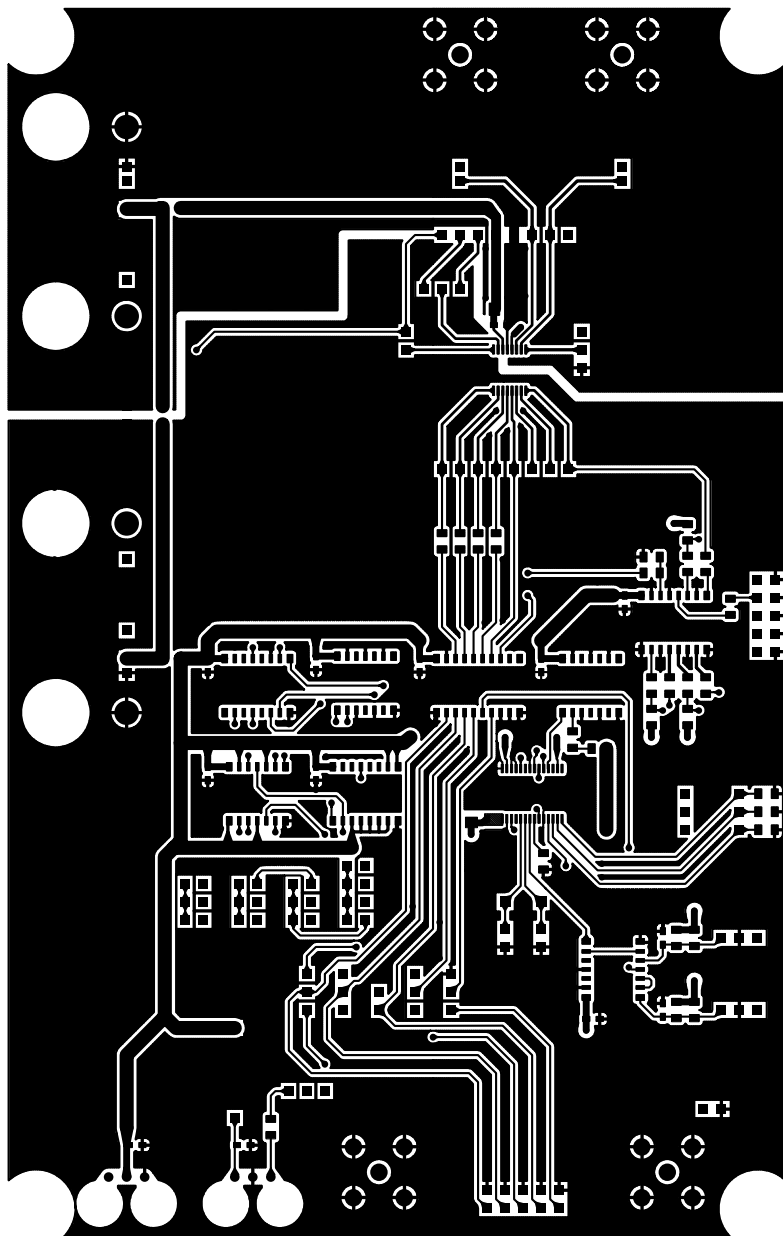

AKD4345-A L1

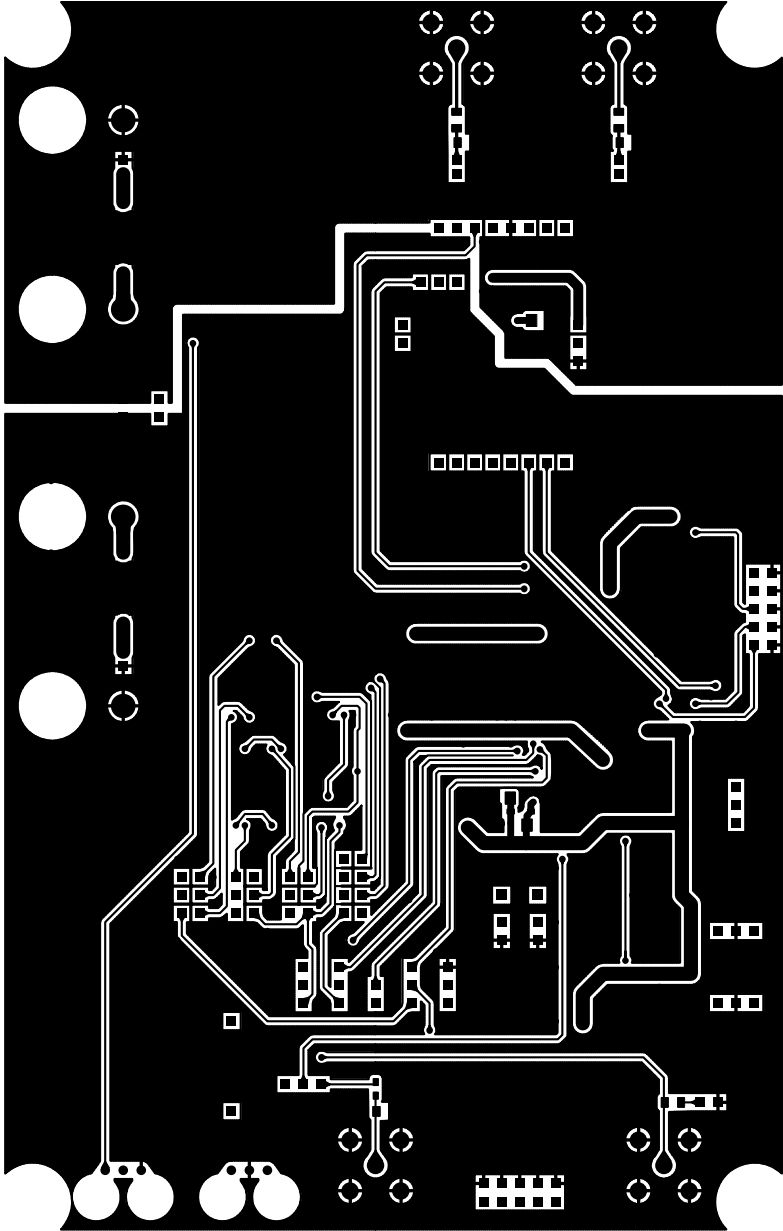

AKD131E2-A FS