



Multiple-Output Clock Generators with Dual PLLs and OTP

General Description

The MAX9471/MAX9472 multipurpose clock generators are ideal for consumer and communication applications. The MAX9471/MAX9472 feature two buffered phase-locked loop (PLL) outputs that can be independently set from 4MHz to 200MHz. These devices also provide one (MAX9472) or two (MAX9471) buffered outputs of the reference clock.

The MAX9471 outputs a set of MPEG/AC3 audio and video frequencies most commonly used in consumer applications. The MAX9472 outputs a set of common audio frequencies. These frequencies are selected through an I²C[†] interface (MAX9471) or by setting the three-level FS pins. The MAX9471/MAX9472 feature a one-time-programmable (OTP) ROM, allowing one-time programming of the two PLL outputs.

The MAX9471/MAX9472 include two basic configurations. In one configuration, the OTP ROM sets PLL1 output to any frequency between 4MHz to 200MHz, and the I²C interface (MAX9471) or programmable pins set the PLL2 output frequency to a set of audio and video frequencies. In the other configuration, the OTP ROM sets both PLL1 and PLL2 frequencies to fixed values between 4MHz to 200MHz. In both cases, the reference output is available, but the OTP ROM can disable it.

The OTP ROM on the MAX9471/MAX9472 is factory set based on the customer requirements. Contact the factory for samples with preferred frequencies.

The devices operate from a 3.3V supply and are specified over the -40°C to +85°C extended temperature range. The MAX9471 is available in a 20-pin TQFN package. The MAX9472 is available in a 14-pin TSSOP package.

Applications

- Digital TVs
- Communication Systems
- Data Networking Systems
- Set-Top Boxes
- Home Entertainment Centers
- Multimedia PCs

†Purchase of I²C components from Maxim Integrated Products, Inc., or one of its sublicensed Associated Companies, conveys a license under the Philips I²C Patent Rights to use these components in an I²C system, provided that the system conforms to the I²C Standard Specification as defined by Philips.

Features

- ◆ 5MHz to 50MHz Input Clock Reference
- ◆ Crystal or Input-Clock-Based Reference
- ◆ Two Fractional-N Feedback PLLs (4MHz to 200MHz) with Buffered Outputs
- ◆ Two Buffered Outputs of Reference Clock
- ◆ OTP for Factory-Preset PLL Frequencies Available (Contact Factory)
- ◆ Programmable Through I²C Interface or Three-Level Logic Pins for Video or Audio Clocks
- ◆ Low-RMS Jitter PLL (14ps for 45MHz)
- ◆ Integrated VCXO with ±200ppm Tuning Range
- ◆ Available in 20-Pin TQFN and 14-Pin TSSOP Packages
- ◆ +3.3V Supply
- ◆ -40°C to +85°C Temperature Range

Ordering Information

PART	TEMP RANGE	PIN-PACKAGE	PKG CODE
MAX9471ETP+**	-40°C to +85°C	20 TQFN-EP*	T2055-5
MAX9472EUD+**	-40°C to +85°C	14 TSSOP	U14-2

*EP = Exposed pad.

**Marking is for samples only. Contact factory for ordering information.

+Denotes lead-free package.

Pin Configurations

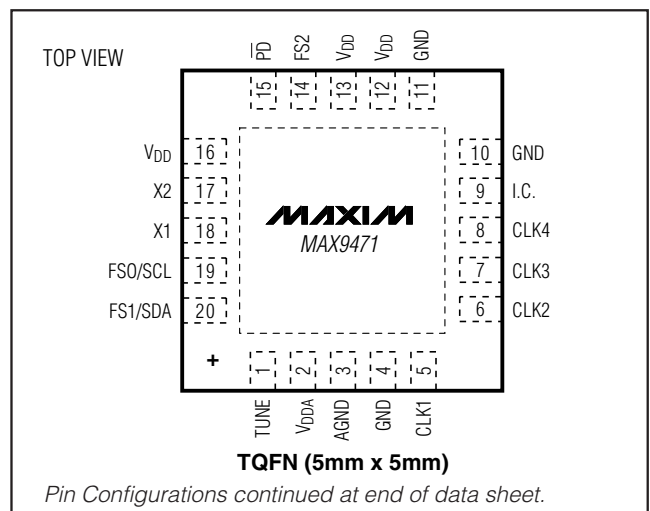

Multiple-Output Clock Generators with Dual PLLs and OTP

ABSOLUTE MAXIMUM RATINGS

V _{DD} to GND	-0.3V to +4.0V	Continuous Power Dissipation (T _A = +70°C)
V _{DDA} to AGND	-0.3V to +4.0V	20-Pin TQFN (derate 21.3mW/°C above +70°C)
AGND to GND	-0.3V to +0.3V	14-Pin TSSOP (derate 9.1mW/°C above +70°C)
All Other Pins to GND	-0.3V to V _{DD} + 0.3V	Storage Temperature Range
Short-Circuit Duration (all LVCMOS outputs)	Continuous	Maximum Junction Temperature
ESD Protection (Human Body Model)	±2kV	Operating Temperature Range
		Lead Temperature (soldering, 10s)

Stresses beyond those listed under "Absolute Maximum Ratings" may cause permanent damage to the device. These are stress ratings only, and functional operation of the device at these or any other conditions beyond those indicated in the operational sections of the specifications is not implied. Exposure to absolute maximum rating conditions for extended periods may affect device reliability.

DC ELECTRICAL CHARACTERISTICS

(V_{DD} = V_{DDA} = +3.0V to +3.6V and T_A = -40°C to +85°C. Typical values at V_{DD} = V_{DDA} = 3.3V, T_A = +25°C, unless otherwise noted.)
(Note 1)

PARAMETER	SYMBOL	CONDITIONS	MIN	TYP	MAX	UNITS
LVCMOS INPUTS (P_D, X1 as a reference INPUT CLK)						
Input High Level	V _{IH1}		2.0		V _{DD}	V
Input Low Level	V _{IL1}		0		0.8	V
Input Current High Level	I _{IH1}	V _{IN} = V _{DD}			20	μA
Input Current Low Level	I _{IL1}	V _{IN} = 0	-20			μA
THREE-LEVEL INPUTS (FS0, FS1, FS2, as FS2 = open)						
Input High Level	V _{IH2}		2.5			V
Input Low Level	V _{IL2}				0.8	V
Input Open Level	V _{IO2}		1.27		2.10	V
Input Current	I _{IL2} , I _{IH2}	V _{IL2} = 0 or V _{IH2} = V _{DD}	-10		+10	μA
SERIAL INTERFACE (SCL, SDA) (Note 2) (MAX9471)						
Input High Level	V _{IH}		0.7 x V _{DD}			V
Input Low Level	V _{IL}				0.3 x V _{DD}	V
Input-Leakage Current	I _{IH} , I _{IL}		-1		+1	μA
Low-Level Output	V _{OL}	I _{SINK} = 4mA			0.4	V
Input Capacitance	C _I	(Note 3)		8.4		pF
CLOCK OUTPUTS (CLK__)						
Output High Level	V _{OH}	I _{OH} = -4mA	V _{DD} - 0.6			V
Output Low Level	V _{OL}	I _{OL} = 4mA			0.4	V
POWER SUPPLIES						
Digital Power-Supply Voltage	V _{DD}		3.0		3.6	V
Analog Power-Supply Voltage	V _{DDA}		3.0		3.6	V
Total Current for Digital and Analog Supplies	I _{DC}	CLK1 at 125MHz and CLK2 at 74.1758MHz; all outputs not loaded		12		mA
Total Power-Down Current	I _{PD}	P _D = low		60		μA

Multiple-Output Clock Generators with Dual PLLs and OTP

MAX9471/MAX9472

AC ELECTRICAL CHARACTERISTICS

($V_{DD} = V_{DDA} = +3.0V$ to $+3.6V$, $T_A = -40^{\circ}C$ to $+25^{\circ}C$. Typical values are at $V_{DD} = V_{DDA} = 3.3V$, $T_A = +25^{\circ}C$ with $f_{XTL} = 27MHz$, unless otherwise noted.) (Note 3)

PARAMETER	SYMBOL	CONDITIONS	MIN	TYP	MAX	UNITS
OUTPUT CLOCKS (CLK1, CLK2)						
Minimum Frequency Range	f_{OUT}	$f_{IN} = 5MHz$ to $50MHz$	4			MHz
Maximum Frequency Range	f_{OUT}	$f_{IN} = 5MHz$ to $50MHz$, $C_L < 5pF$	133	200		MHz
Clock Rise Time	t_R	20% to 80% of V_{DD} , $C_L = 10pF$, $f_{OUT} = 74.1758MHz$ (Figure 5)		1.4		ns
Clock Fall Time	t_F	80% to 20% of V_{DD} , $C_L = 10pF$, $f_{OUT} = 74.1758MHz$ (Figure 5)		1.2		ns
Duty Cycle		$f_{OUT} = 74.1758MHz$, $C_L = 10pF$	42	50	58	%
Output Period Jitter	JP	125MHz, $C_L = 5pF$, $f_{IN} = 27MHz$		26.3		RMSps
		74.1758MHz, $C_L = 10pF$, $f_{IN} = 27MHz$		33.6		
Soft Power-On Time	t_{FST}	SDA from low to high, $f_{OUT} = 71.1758MHz$, $f_{IN} = 13MHz$ (Figure 6)		1		ms
Hard Power-On Time	t_{PO1}	(Figure 6)		15		ms
VCXO CLOCKS (CLK3, CLK4)						
Crystal Frequency	f_{XTL}			27		MHz
Crystal Accuracy				± 30		ppm
Tuning Voltage Range	V_{TUNE}		0.0		3.0	V
VCXO Tuning Range		$V_{TUNE} = 0$ to $3V$, $C_1 = C_2 = 4.0pF$	± 150	± 200		ppm
TUNE Input Impedance	Z_{TUNE}			95		$k\Omega$
Output CLK Accuracy		$V_{TUNE} = 1.5V$, $C_1 = C_2 = 4.0pF$		± 50		ppm
Output Duty Cycle		$C_L = 10pF$ load, CLK3	40	50	60	%
Output Period Jitter		$C_L = 10pF$		36		RMSps
Output Rise Time	t_R	20% to 80% of V_{DD} (Figure 5), $C_L = 10pF$		1.4		ns
Output Fall Time	t_F	80% to 20% of V_{DD} (Figure 5), $C_L = 10pF$		1.4		ns

Multiple-Output Clock Generators with Dual PLLs and OTP

SERIAL-INTERFACE TIMING CHARACTERISTICS (MAX9471)

(V_{DD} = V_{DDA} = +3.3V, T_A = -40°C to +85°C, unless otherwise noted.) (Note 1, Figure 2)

PARAMETER	SYMBOL	CONDITIONS	MIN	TYP	MAX	UNITS
Serial Clock	f _{SCL}				400	kHz
Bus Free Time Between STOP and START Conditions	t _{BUF}		1.3			μs
Hold Time, Repeated START Condition	t _{HD,STA}		0.6			μs
Repeated START Condition Setup Time	t _{SU,STA}		0.6			μs
STOP Condition Setup Time	t _{SU,STO}		0.6			μs
Data Hold Time	t _{HD,DAT}	(Note 4)	15		900	ns
Data Setup Time	t _{SU,DAT}		100			ns
SCL Clock Low Period	t _{LOW}		1.3			μs
SCL Clock High Period	t _{HIGH}		0.7			μs
Rise Time of SDA and SCL, Receiving	t _R	(Notes 3, 5)	20 + 0.1C _b		300	ns
Fall Time of SDA and SCL, Receiving	t _F	(Notes 3, 5)	20 + 0.1C _b		300	ns
Fall Time of SDA, Transmitting	t _{F,TX}	(Notes 3, 6)	20 + 0.1C _b		250	ns
Pulse Width of Spike Suppressed	t _{SP}	(Notes 3, 7)	0		50	ns
Capacitive Load for Each Bus Line	C _b	(Note 3)			400	pF

Note 1: All parameters are tested at T_A = +25°C. Specifications over temperature are guaranteed by design.

Note 2: No high-output level is specified, only the output resistance to the bus. Pullup resistors on the bus provide the high-level voltage.

Note 3: Guaranteed by design.

Note 4: A master device must provide a hold time of at least 300ns for the SDA signal (referred to V_{IL} of the SCL signal) to bridge the undefined region of SCL's falling edge.

Note 5: C_b = total capacitance of one bus line in pF. t_R and t_F measured between 0.3 x V_{DD} and 0.7 x V_{DD}.

Note 6: Bus sink current is less than 6mA. C_b is the total capacitance of one bus line in pF. t_R and t_F are measured between 0.3 x V_{DD} and 0.7 x V_{DD}.

Note 7: Input filters on the SDA and SCL inputs suppress noise spikes less than 50ns.

Multiple-Output Clock Generators with Dual PLLs and OTP

Typical Operating Characteristics

(VDD = VDDA = +3.3V, TA = +25°C, fXTL = 27MHz, unless otherwise noted.)

MAX9471/MAX9472

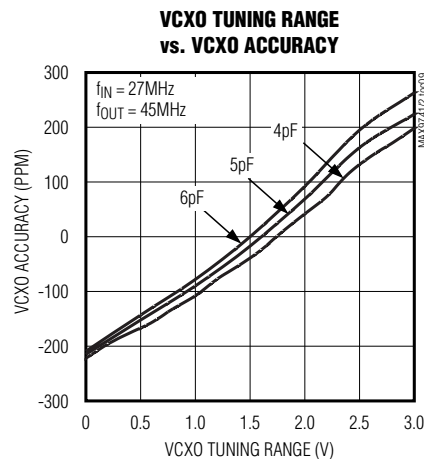
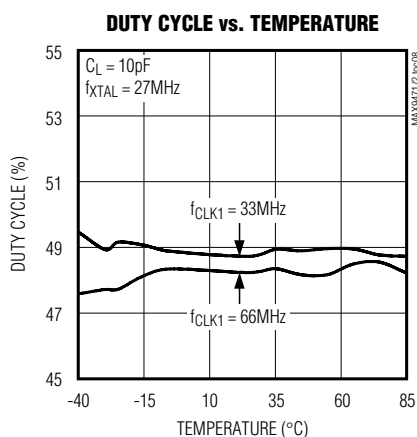
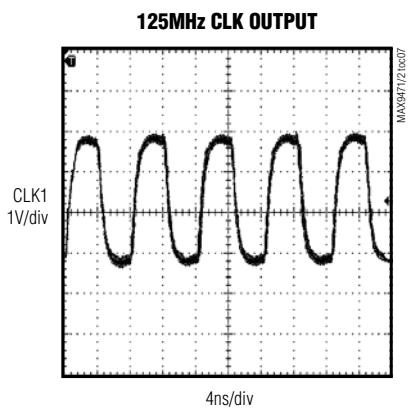
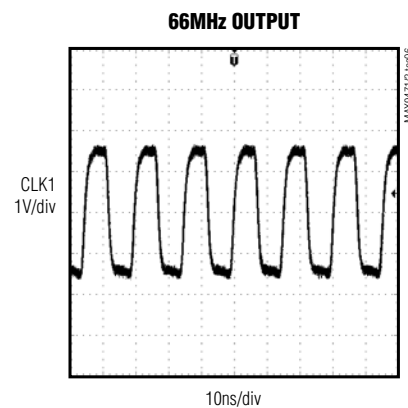
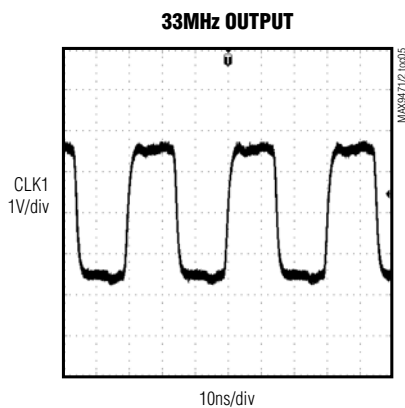
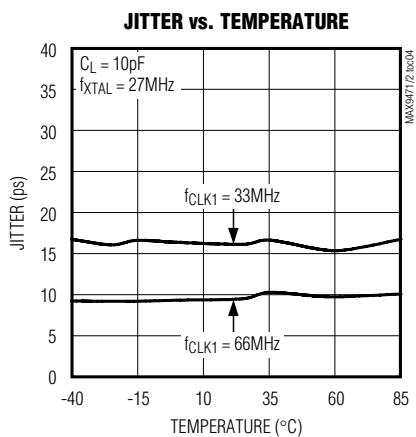
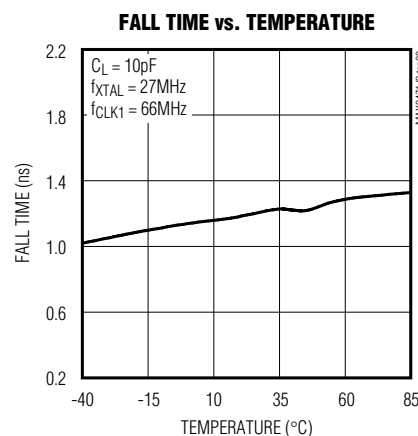
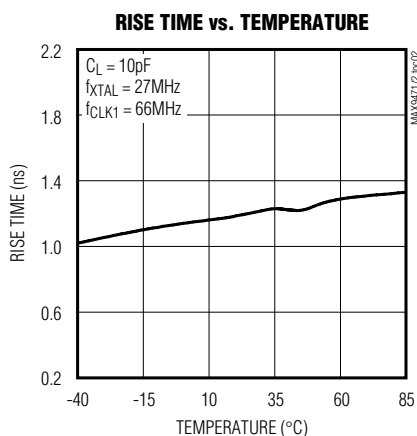
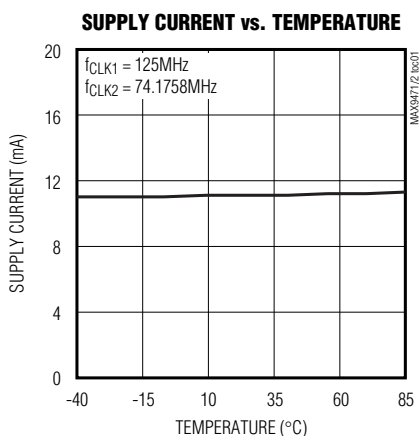

Multiple-Output Clock Generators with Dual PLLs and OTP

Typical Operating Circuit/Block Diagram

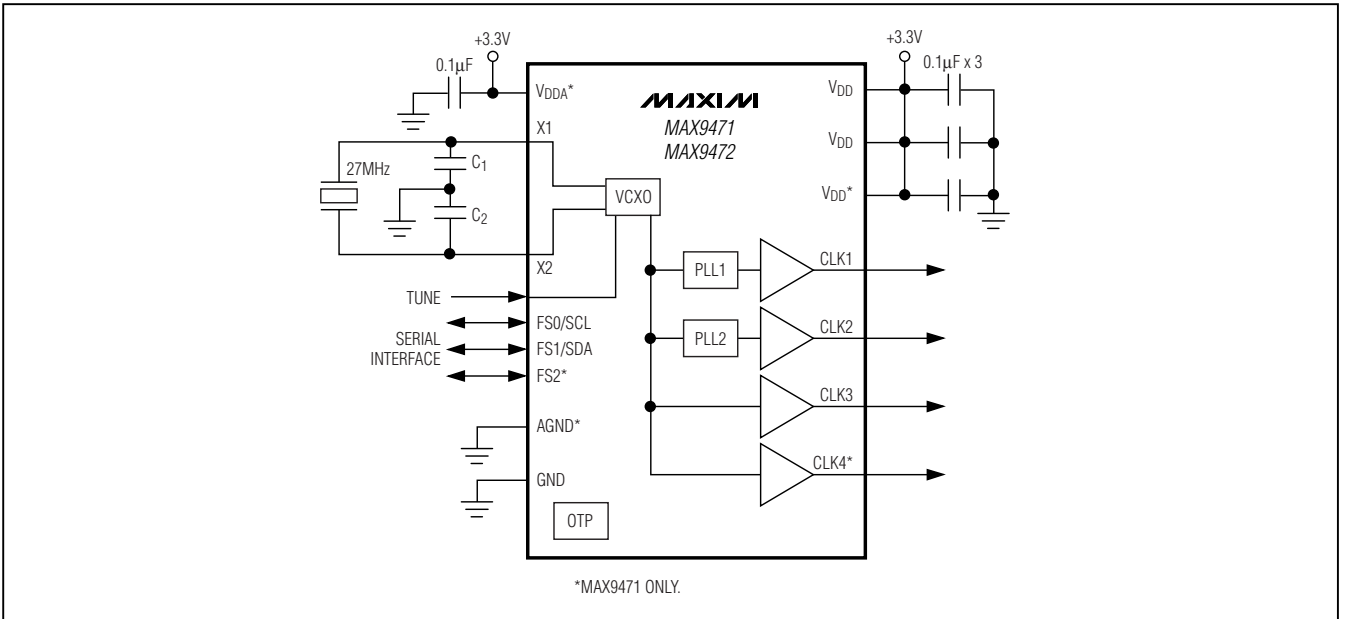

Pin Description

PIN		NAME	FUNCTION
MAX9471	MAX9472		
1	5	TUNE	VCXO Tune Voltage Input. If using a reference clock input, connect TUNE to VDD.
2	—	VDDA	Analog Power Supply. Bypass to GND with a 0.1µF capacitor.
3	—	AGND	Analog Ground
4, 10, 11	6, 10, 11	GND	Ground
5	7	CLK1	Output Clock 1. PLL1 buffered output.
6	8	CLK2	Output Clock 2. PLL2 buffered output.
7	9	CLK3	Output Clock 3. VCXO buffered output.
8	—	CLK4	Output Clock 4. VCXO buffered output.
9	—	I.C.	Internally Connected. Leave unconnected.
12, 13, 16	4, 12	VDD	Power Supply. Bypass to GND with a 0.1µF capacitor.
14	—	FS2	Function Select 2
15	13	$\overline{\text{PD}}$	Active-Low, Power-Down Input. Pull high for normal operation, drive $\overline{\text{PD}}$ low to place MAX9471/MAX9472 in power-down mode.
17	14	X2	Crystal Connection 2. Leave open if using a reference clock.
18	1	X1	Crystal Connection 1 or Reference Clock Input
19	—	FS0/SCL	Function Select 0/Serial Clock. Set FS2 high to place the device in I ² C mode (see Table 1).
20	—	FS1/SDA	Function Select 1/Serial Data. Set FS2 high to place the device in I ² C mode (see Table 1).
—	2	FS1	Function Select 1
—	3	FS0	Function Select 0
EP	—	EP	Exposed Pad (MAX9471 only). Connect EP to GND.

Multiple-Output Clock Generators with Dual PLLs and OTP

Detailed Description

The MAX9471/MAX9472 have two programmable fractional-N feedback PLLs so that almost any frequencies between 4MHz to 200MHz can be generated. The MAX9471 provides four outputs: two for the PLLs and two for the reference clock. The MAX9472 provides three outputs: two for the PLLs and one for the reference clock. The crystal frequency can be between 5MHz and 30MHz. The internal VCXO has a fine-tuning range of ± 200 ppm.

Power-Down

Driving \overline{PD} low places the MAX9471/MAX9472 in power-down mode. \overline{PD} overrides all other functions, setting all outputs to high impedance and shutting down the two PLLs. Every output has an 80k Ω (typ) internal pulldown resistor.

Voltage-Controlled Crystal Oscillator (VCXO)

The MAX9471/MAX9472s' internal VCXO produces a reference clock for the PLLs used to generate the output clocks. The oscillator uses a crystal clock as the base frequency reference and has a voltage-controlled tuning input for micro adjustment in a range of ± 200 ppm. The tuning voltage V_{TUNE} can vary from 0V to 3V as shown in Figure 1. The crystal should be AT cut and oscillate on its fundamental mode with ± 30 ppm accuracy. The crystal shunt capacitor should be less than 10pF, including board parasitic capacitance. To achieve up to ± 200 ppm pullability, the crystal-loading capacitance should be less than 14pF. The VCXO is a free-running oscillator. It starts oscillating with an internal POR signal and can be disabled by \overline{PD} . VCXO settles at approximately 5ms at power-on and 10 μ s at a change of the V_{TUNE} voltage.

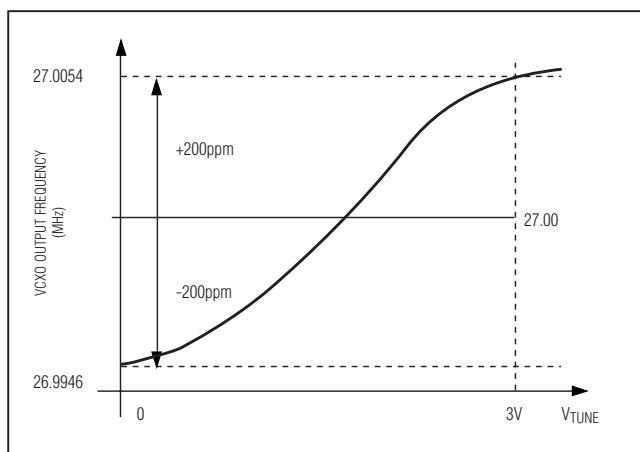

Figure 1. VCXO Tuning Range for a 27MHz Crystal

Choosing different C_1 and C_2 capacitors allows flexibility for centering the various crystals. See the *Typical Operating Characteristics* for an example.

To use the MAX9471/MAX9472 as a synthesizer with an input reference clock, connect the input clock to X1 and TUNE to V_{DD} , and leave X2 unconnected. This configuration is for applications where the micro tuning is not needed, and there is a system reference clock available.

One-Time Programmable Memory

The MAX9471/MAX9472 feature a factory-configurable, OTP memory for nonvolatile applications allowing for simple and permanent clock generation. Contact the factory for presetting the MAX9471/MAX9472 to requested frequencies.

Using OTP, the MAX9471/MAX9472 can be configured to two different configurations. One configuration is to have PLL1 set to any frequency between 4MHz to 200MHz and select the PLL2's frequency by I²C (MAX9471) or programmable pins. The second configuration is to preset the frequencies in PLL1 and PLL2 to fixed values between 4MHz to 200MHz. In both cases, the reference output is available, but it can be disabled by OTP. At power-up, all the outputs are enabled.

Frequency Selection of CLK2 Output

The OTP ROM can set PLL2's output to be selectable from a group of frequencies that are common for MPEG video and audio applications. The frequency selection can be done by the FS_ inputs or through the I²C interface (MAX9471). For the MAX9471, pull FS2 high (Table 1) to select the PLL2 frequency through the I²C interface. Otherwise, the frequencies are selected according to Table 2. For the MAX9471, Table 3 shows the mappings for I²C programming.

Serial Interface (MAX9471)

The MAX9471 can be programmed through a 2-wire, I²C-compatible serial interface. The device is activated after power-up and FS2 = high. The device operates as a slave that sends and receives data through clock line SCL and data line SDA for bidirectional communication with the master. A master (typically a microcontroller) initiates all data transfers to and from the MAX9471 and

Table 1. Mode Selection by FS2 (MAX9471 Only)

FS2	MODE
Low or open	Pin programmable
High	I ² C enabled

Multiple-Output Clock Generators with Dual PLLs and OTP

Table 2. MAX9471/MAX9472 Frequency Selection at CLK2

FS2	FS1	FS0	FREQUENCY (MHz)
AUDIO FREQUENCIES			
Open	Open	Open	4.096
Open	Open	Low	6.144
Open	Open	High	8.1920
Open	Low	High	11.2896
Open	Low	Open	12.2880
Open	Low	Low	16.3840
Open	High	High	22.5792
Open	High	Open	24.5760
Open	High	Low	9.216
Low	Open	High	16.9344
Low	Open	Open	18.4320
Low	Open	Low	33.8688
Low	High	High	36.864
VIDEO FREQUENCIES			
Low	Low	Low	74.1758241
Low	Low	High	74.25
Low	Low	Open	54.054
High	X	X	Disable three-level pins and enable I ² C

*MAX9472 can be programmed to FS2 = open settings only.

Table 3. MAX9471 I²C Frequency Selection at CLK2 (FS2 = High)

A4	A3	A2	A1	FREQUENCY (MHz)
AUDIO FREQUENCIES				
0	0	0	0	4.096
0	0	0	1	6.144
0	0	1	0	8.1920
0	0	1	1	11.2896
0	1	0	0	12.2880
0	1	0	1	16.3840
0	1	1	0	22.5792
0	1	1	1	24.5760
1	0	0	0	9.216
1	0	0	1	16.9344
1	0	1	0	18.4320
1	0	1	1	33.8688
1	1	0	0	36.864
VIDEO FREQUENCIES				
1	1	0	1	74.1758241
1	1	1	0	74.25
1	1	1	1	54.054

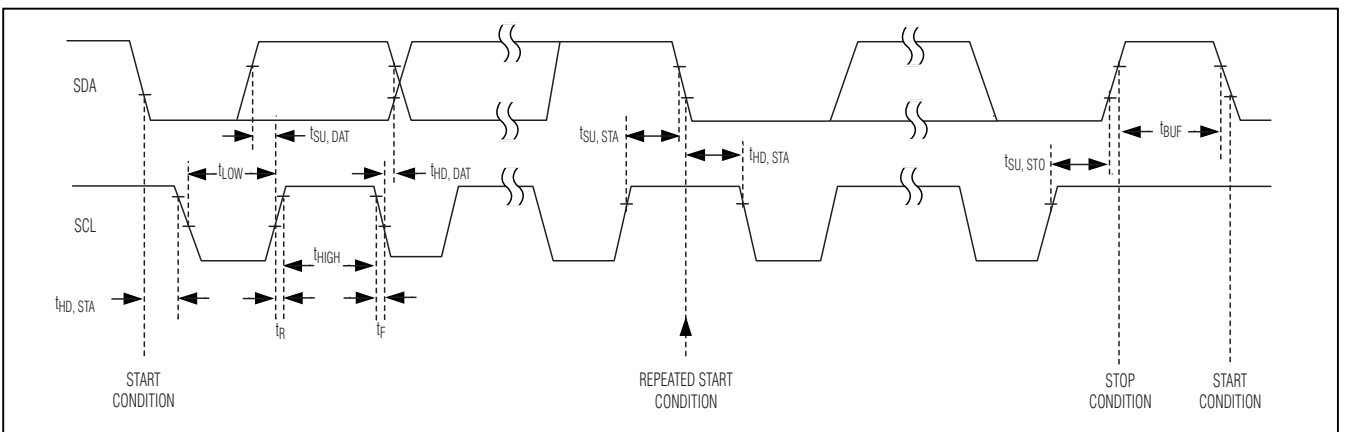

Figure 2. I²C Timing Diagram

generates the SCL clock that synchronizes the data transfer. The SDA line operates as both an input and an open-drain output. A pullup resistor, typically 4.7k Ω , is required on SDA. The SCL line operates only as an

input. A pullup resistor, typically 4.7k Ω , is required on SCL if there are multiple masters on the 2-wire bus, or if the master in a single-master system has an open-drain SCL output. Figure 2 is the I²C timing diagram.

Multiple-Output Clock Generators with Dual PLLs and OTP

Device Address

The default I²C address for the MAX9471 is factory set to 1100111. Contact factory for different addresses.

START and STOP Conditions

Both SCL and SDA remain high when the interface is not busy. The active master signals the beginning of a transmission with a START (S) condition by transitioning SDA from high to low while SCL is high. When the master has finished communicating with the slave, it issues a STOP (P) condition by transitioning SDA from low to high while SCL is high. The bus is then free for another transmission (Figure 3).

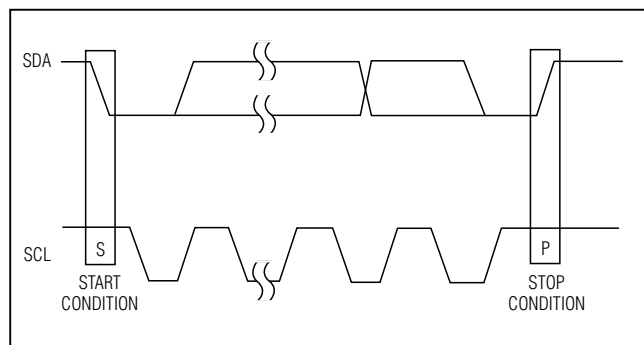

Figure 3. START and STOP Diagram

Data Transfer and ACK

Following the START condition, each SCL clock pulse transfers 1 bit. Between a START and a STOP, multiple bits are transferred on the 2-wire bus. The first 7 bits are for the device address. Bit 8 indicates the writing (low) or reading (high) operation (R/W). Bit 9 is the ACK for the address and operation type. The next 8 bits (bit 10 to bit 17) form the content byte. The next bit, bit 18, is the ACK for the content byte. The master always transfers the first 8 bits (address + R/W). The slave (MAX9471) may receive a content byte from the bus or transfer a content byte to the bus. The ACK bits are transmitted by the address or content recipient. A low-ACK bit indicates a successful transfer; otherwise, a high-ACK bit indicates an unsuccessful transfer. More content bytes can be continuously transferred until the master sends a STOP. For the MAX9471 data writing, after the 9 bits with the slave ID, R/W, and ACK, 1 data byte is sent to the MAX9471 from the master. Figure 4 shows the structure of the data transfer. Figure 5 shows CLK_r rise and fall times.

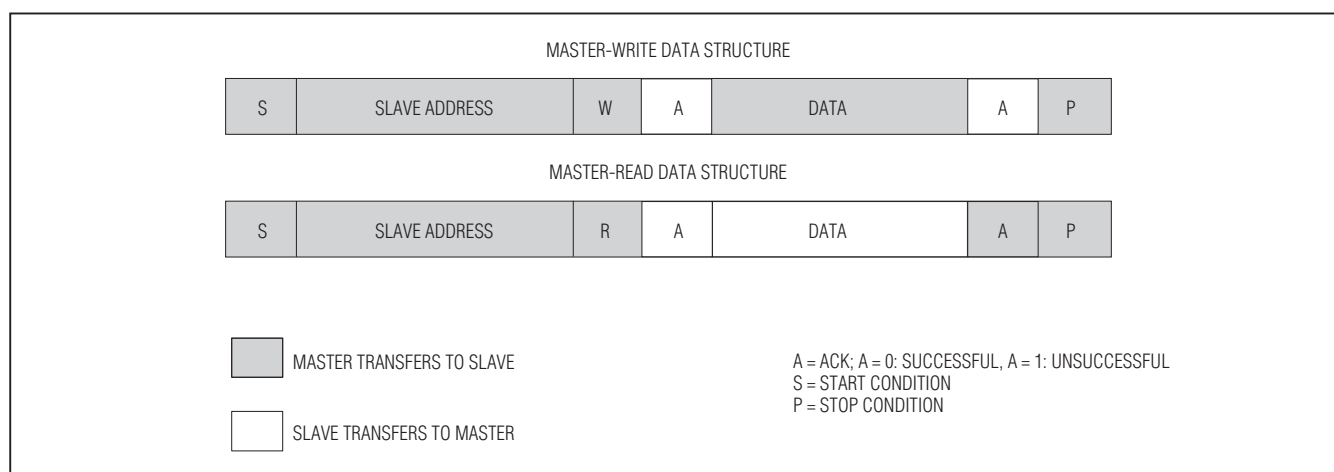

Figure 4. Serial-Interface Data Structure

Multiple-Output Clock Generators with Dual PLLs and OTP

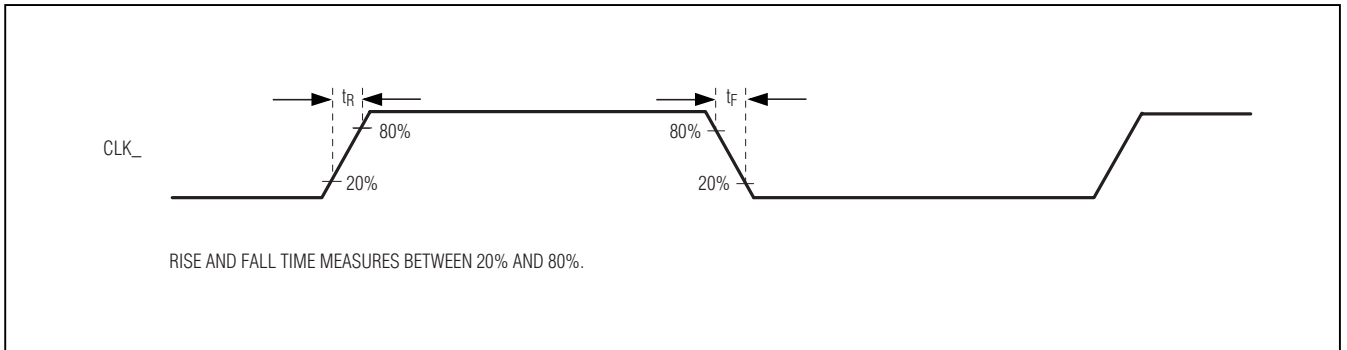

Figure 5. CLK_ Rise and Fall Times

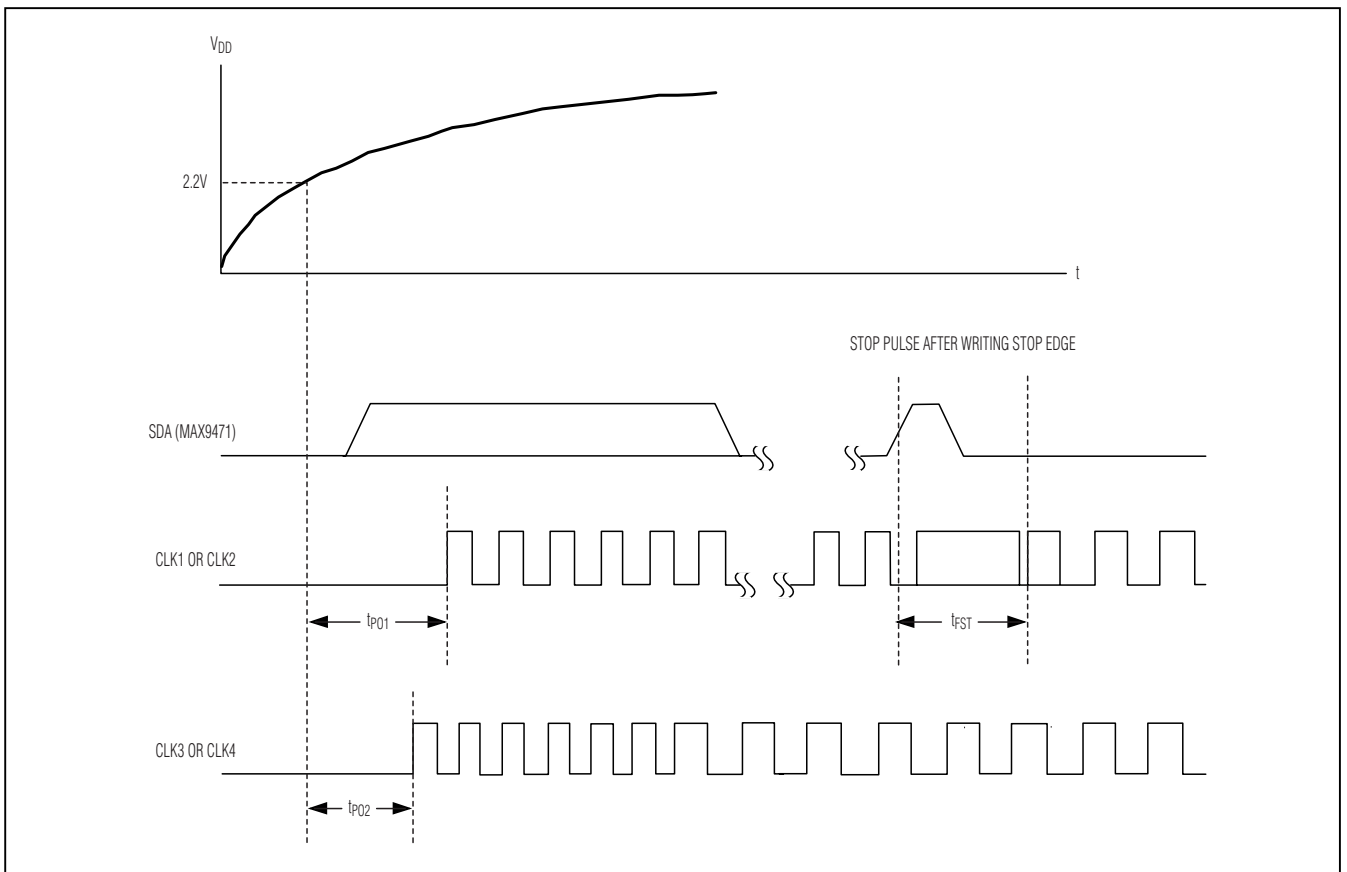

Figure 6. VCXO and PLL Timing Diagram

Multiple-Output Clock Generators with Dual PLLs and OTP

Applications Information

Crystal Selection

When using a crystal with the MAX9471/MAX9472s' internal oscillator, connect the crystal to X1 and X2. Choose an AT-cut crystal that oscillates on its fundamental mode with ± 30 ppm and loading capacitance less than 14pF. To achieve a wide VCXO tuning range, select a crystal with motional capacitance greater than 7fF and connect 6pF or less shunt capacitors at X1 and X2 to ground. When the VCXO is used as an oscillator, select both shunt capacitors to be approximately 13pF. The optimal shunt capacitors for achieving minimum frequency offset can be determined experimentally.

Board Layout Considerations and Bypassing

The MAX9471/MAX9472s' oscillator frequencies make proper layout important to ensure stability. For best performance, place components as close as possible to the device.

Digital or AC transient signals on GND can create noise at the clock output. Return GND to the highest quality ground available. Bypass each VDD and VDDA with a 0.1 μ F capacitor, placed as close as possible to the device. Careful PC board ground layout minimizes crosstalk between the outputs and digital inputs.

Pin Configurations (continued)

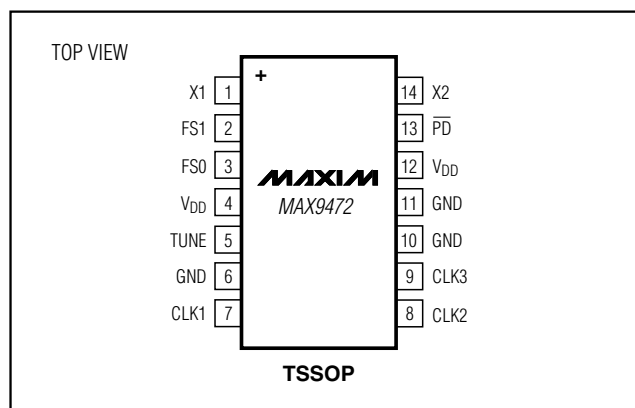

Chip Information

PROCESS: CMOS

MAX9471/MAX9472

Multiple-Output Clock Generators with Dual PLLs and OTP

Package Information

(The package drawing(s) in this data sheet may not reflect the most current specifications. For the latest package outline information, go to www.maxim-ic.com/packages.)

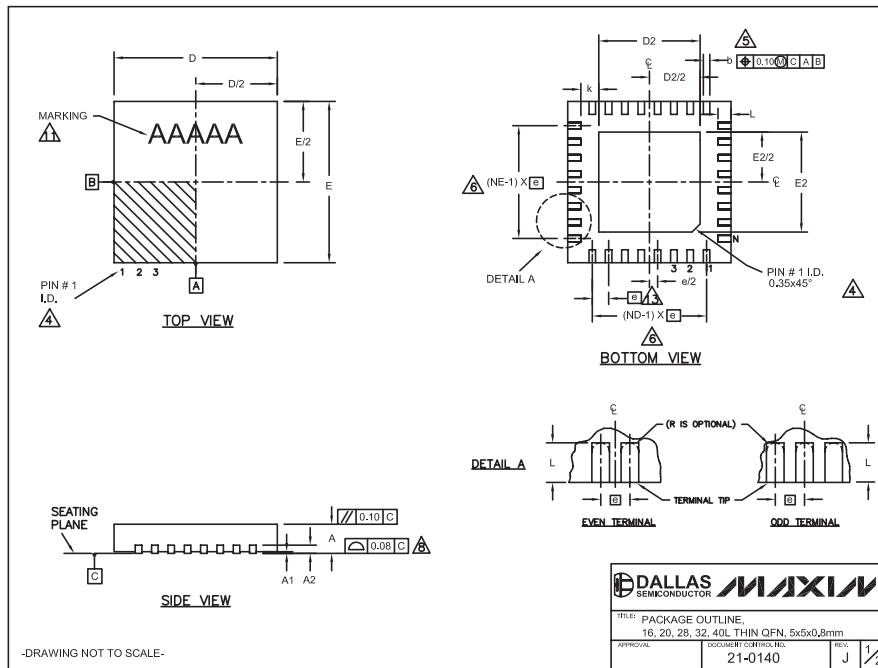

QFN THIN.EPS

COMMON DIMENSIONS															
PKG.	16L 5x5			20L 5x5			28L 5x5			32L 5x5			40L 5x5		
SYMBOL	MIN.	NOM.	MAX.	MIN.	NOM.	MAX.	MIN.	NOM.	MAX.	MIN.	NOM.	MAX.	MIN.	NOM.	MAX.
A	0.70	0.75	0.80	0.70	0.75	0.80	0.70	0.75	0.80	0.70	0.75	0.80	0.70	0.75	0.80
A1	0	0.02	0.05	0	0.02	0.05	0	0.02	0.05	0	0.02	0.05	0	0.02	0.05
A2	0.20 REF.			0.20 REF.			0.20 REF.			0.20 REF.			0.20 REF.		
b	0.25	0.30	0.35	0.25	0.30	0.35	0.20	0.25	0.30	0.20	0.25	0.30	0.15	0.20	0.25
D	4.90	5.00	5.10	4.90	5.00	5.10	4.90	5.00	5.10	4.90	5.00	5.10	4.90	5.00	5.10
E	4.90	5.00	5.10	4.90	5.00	5.10	4.90	5.00	5.10	4.90	5.00	5.10	4.90	5.00	5.10
e	0.80 BSC.			0.65 BSC.			0.50 BSC.			0.50 BSC.			0.40 BSC.		
k	0.25	-	-	0.25	-	-	0.25	-	-	0.25	-	-	0.25	-	-
L	0.30	0.40	0.50	0.45	0.55	0.65	0.45	0.55	0.65	0.30	0.40	0.50	0.30	0.40	0.50
N	16			20			28			32			40		
ND	4			5			7			8			10		
NE	4			5			7			8			10		
JEDEC	WHHB			WHHC			WHHD-1			WHHD-2			---		

EXPOSED PAD VARIATIONS								
PKG. CODES	D2			E2				
	MIN.	NOM.	MAX.	MIN.	NOM.	MAX.		
T1655-2	3.00	3.10	3.20	3.00	3.10	3.20		
T1655-3	3.00	3.10	3.20	3.00	3.10	3.20		
T1655N-1	3.00	3.10	3.20	3.00	3.10	3.20		
T2055-3	3.00	3.10	3.20	3.00	3.10	3.20		
T2055-4	3.00	3.10	3.20	3.00	3.10	3.20		
T2055-6	3.15	3.25	3.35	3.15	3.25	3.35		
T2855-3	3.15	3.25	3.35	3.15	3.25	3.35		
T2855-4	2.60	2.70	2.80	2.60	2.70	2.80		
T2855-5	2.60	2.70	2.80	2.60	2.70	2.80		
T2855-6	3.15	3.25	3.35	3.15	3.25	3.35		
T2855-7	2.60	2.70	2.80	2.60	2.70	2.80		
T2855-8	3.15	3.25	3.35	3.15	3.25	3.35		
T2855N-1	3.15	3.25	3.35	3.15	3.25	3.35		
T3255-3	3.00	3.10	3.20	3.00	3.10	3.20		
T3255-4	3.00	3.10	3.20	3.00	3.10	3.20		
T3255-6	3.00	3.10	3.20	3.00	3.10	3.20		
T3255N-1	3.00	3.10	3.20	3.00	3.10	3.20		
T4055-1	3.40	3.50	3.60	3.40	3.50	3.60		
T4055-2	3.40	3.50	3.60	3.40	3.50	3.60		

NOTES:

- DIMENSIONING & TOLERANCING CONFORM TO ASME Y14.5M-1994.
- ALL DIMENSIONS ARE IN MILLIMETERS, ANGLES ARE IN DEGREES.
- N IS THE TOTAL NUMBER OF TERMINALS.
- THE TERMINAL #1 IDENTIFIER AND TERMINAL NUMBERING CONVENTION SHALL CONFORM TO JEDEC 95-1 SPP-012. DETAILS OF TERMINAL #1 IDENTIFIER ARE OPTIONAL, BUT MUST BE LOCATED WITHIN THE ZONE INDICATED. THE TERMINAL #1 IDENTIFIER MAY BE EITHER A MOLD OR MARKED FEATURE.
- DIMENSION b APPLIES TO METALLIZED TERMINAL AND IS MEASURED BETWEEN 0.25 mm AND 0.30 mm FROM TERMINAL TIP.
- ND AND NE REFER TO THE NUMBER OF TERMINALS ON EACH D AND E SIDE RESPECTIVELY.
- DEPOPULATION IS POSSIBLE IN A SYMMETRICAL FASHION.
- COPLANARITY APPLIES TO THE EXPOSED HEAT SINK SLUG AS WELL AS THE TERMINALS.
- DRAWING CONFORMS TO JEDEC MO220, EXCEPT EXPOSED PAD DIMENSION FOR T2855-3 AND T2855-6.
- WARPAGE SHALL NOT EXCEED 0.10 mm.
- MARKING IS FOR PACKAGE ORIENTATION REFERENCE ONLY.
- NUMBER OF LEADS SHOWN ARE FOR REFERENCE ONLY.
- LEAD CENTERLINES TO BE AT TRUE POSITION AS DEFINED BY BASIC DIMENSION "e", ±0.05.

-DRAWING NOT TO SCALE-

Multiple-Output Clock Generators with Dual PLLs and OTP

Package Information (continued)

(The package drawing(s) in this data sheet may not reflect the most current specifications. For the latest package outline information, go to www.maxim-ic.com/packages.)

MAX9471/MAX9472

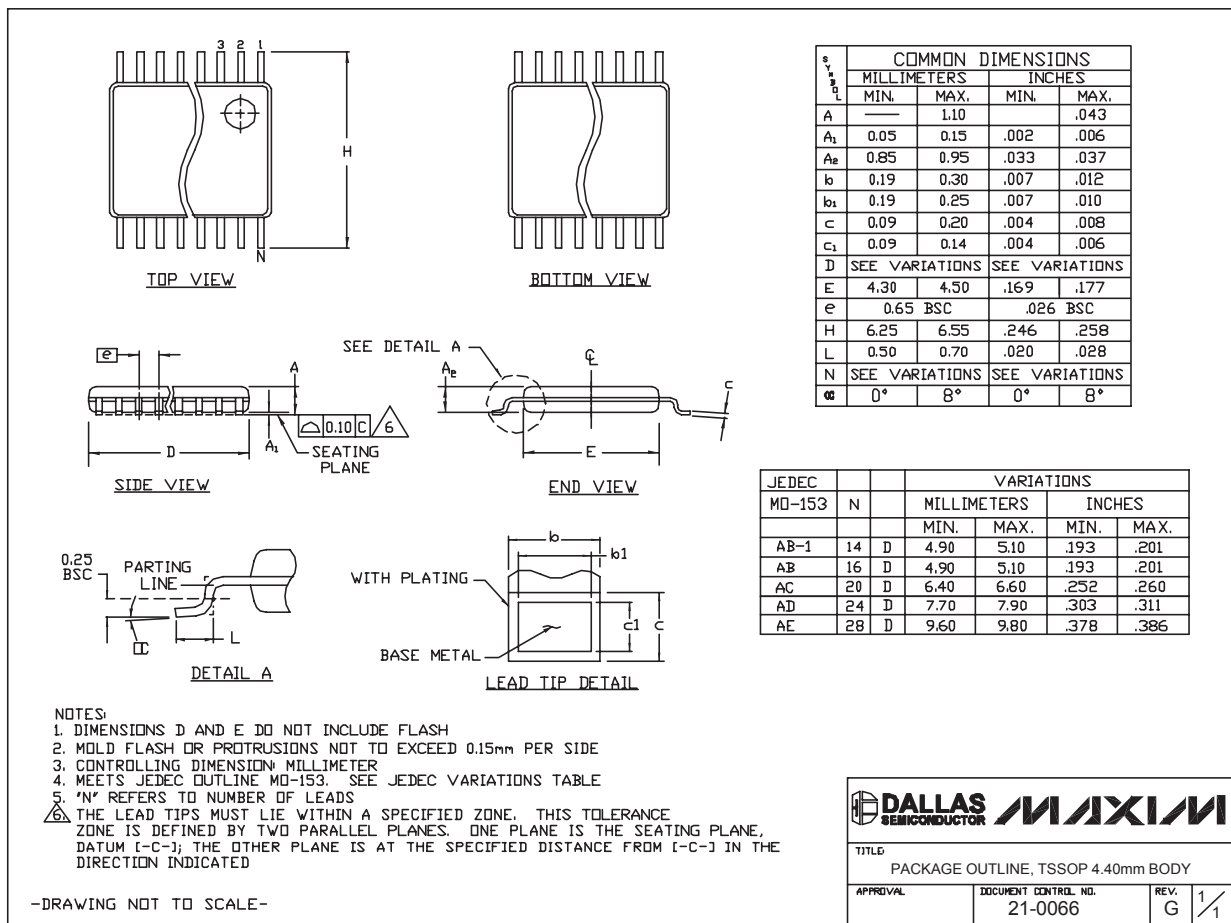

TSSOP4.40mm.EPS

TITLE	
PACKAGE OUTLINE, TSSOP 4.40mm BODY	
APPROVAL	DOCUMENT CONTROL NO.
	21-0066
REV.	1/1
G	

Maxim cannot assume responsibility for use of any circuitry other than circuitry entirely embodied in a Maxim product. No circuit patent licenses are implied. Maxim reserves the right to change the circuitry and specifications without notice at any time.

Maxim Integrated Products, 120 San Gabriel Drive, Sunnyvale, CA 94086 408-737-7600 _____ 13