

BGU7003

Wideband silicon germanium low-noise amplifier MMIC

Rev. 01 — 2 March 2009

Product data sheet

1. Product profile

1.1 General description

The BGU7003 MMIC is a wideband amplifier in SiGe:C technology for high speed, low-noise applications in a plastic, leadless 6 pin, extremely thin small outline SOT891 package.

CAUTION



This device is sensitive to ElectroStatic Discharge (ESD). Therefore care should be taken during transport and handling.

1.2 Features

- Low noise high gain microwave MMIC
- Applicable between 40 MHz and 6 GHz
- Integrated temperature stabilized bias for easy design
- Bias current configurable with external resistor
- Noise figure NF = 0.80 dB at 1.575 GHz
- Insertion power gain = 18.3 dB at 1.575 GHz
- 110 GHz transit frequency - SiGe:C technology
- Power-down mode current consumption < 1 μ A
- Optimized performance at low 5 mA supply current
- ESD protection > 1 kV Human Body Model (HBM) on all pins

1.3 Applications

- GPS
- Satellite radio
- Low-noise amplifiers for microwave communications systems
- WLAN and CDMA applications
- Analog / digital cordless applications

1.4 Quick reference data

Table 1. Quick reference data

$T_{amb} = 25\text{ °C}$; $V_{CC} = 2.5\text{ V}$; $I_{CC(tot)} = 5.0\text{ mA}$; $V_{ENABLE} \geq 0.7\text{ V}$; $f = 1575\text{ MHz}$; $Z_S = Z_L = 50\text{ }\Omega$ (input and output matched to $50\text{ }\Omega$) unless otherwise specified.

Symbol	Parameter	Conditions	Min	Typ	Max	Unit
V_{CC}	supply voltage	RF input AC coupled	2.2	-	2.85	V
$I_{CC(tot)}$	total supply current	configurable with external resistor	[1] 3	-	15	mA
T_{amb}	ambient temperature		-40	+25	+85	°C
P_{tot}	total power dissipation	$T_{sp} \leq 103\text{ °C}$	[2] -	-	70	mW
$ S_{21} ^2$	Insertion power gain		-	18.3	-	dB
NF	noise figure		-	0.80	-	dB
$P_{I(1dB)}$	input power at 1 dB gain compression		-	-20.1	-	dBm
IP_{3I}	input third-order intercept point	jammers at $f_1 = f + 138\text{ MHz}$ and $f_2 = f + 276\text{ MHz}$	-	-0.2	-	dBm

[1] $I_{CC(tot)} = I_{CC} + I_{RF_OUT} + I_{R_BIAS}$.

[2] T_{sp} is the temperature at the solder point of the ground lead.

2. Pinning information

Table 2. Pinning

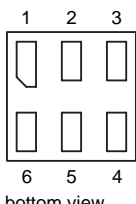
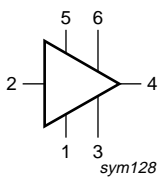
Pin	Description	Simplified outline	Graphic symbol
1	R_BIAS	 bottom view	 sym128
2	RF_IN		
3	GND		
4	RF_OUT		
5	ENABLE		
6	V_{CC}		

3. Ordering information

Table 3. Ordering information

Type number	Package		
	Name	Description	Version
BGU7003	XSON6	plastic extremely thin small outline package; no leads; 6 terminals; body $1 \times 1 \times 0.5\text{ mm}$	SOT891

4. Marking

Table 4. Marking codes

Type number	Marking code
BGU7003	B3

5. Limiting values

Table 5. Limiting values

In accordance with the Absolute Maximum Rating System (IEC 60134).

Symbol	Parameter	Conditions	Min	Max	Unit
V_{CC}	supply voltage	RF input AC coupled	-	3.0	V
$I_{CC(tot)}$	total supply current	configurable with external resistor	-	25	mA
P_{tot}	total power dissipation	$T_{sp} \leq 103\text{ °C}$	[1]	70	mW
T_{stg}	storage temperature		-65	+150	°C
T_j	junction temperature		-	150	°C

[1] T_{sp} is the temperature at the solder point of the ground lead.

6. Thermal characteristics

Table 6. Thermal characteristics

Symbol	Parameter	Conditions	Typ	Unit
$R_{th(j-sp)}$	thermal resistance from junction to solder point		235	K/W

7. Characteristics

Table 7. Characteristics

$T_{amb} = 25\text{ °C}$; $V_{CC} = 2.5\text{ V}$; $I_{CC(tot)} = 5.0\text{ mA}$; $V_{ENABLE} \geq 0.7\text{ V}$ unless otherwise specified. All measurements done on characterization board without matching, de-embedded up to the pins.

Symbol	Parameter	Conditions	Min	Typ	Max	Unit
V_{CC}	supply voltage	RF input AC coupled	2.2	-	2.85	V
$I_{CC(tot)}$	total supply current	configurable with external resistor [1]	3	-	15	mA
		$V_{ENABLE} \leq 0.4\text{ V}$ [1]	-	-	0.001	mA
T_{amb}	ambient temperature		-40	+25	+85	°C
$ S_{21} ^2$	insertion power gain	$T_{amb} = 25\text{ °C}$				
		$f = 1.575\text{ GHz}$	16.0	17.5	-	dB
		$f = 2.4\text{ GHz}$ [2]	14.0	15.2	-	dB
		$f = 5.8\text{ GHz}$ [2]	10.0	11.4	-	dB
		$-40\text{ °C} \leq T_{amb} \leq 85\text{ °C}$				
		$f = 1.575\text{ GHz}$ [2]	15.0	17.5	-	dB
		$f = 2.4\text{ GHz}$ [2]	13.0	15.2	-	dB
		$f = 5.8\text{ GHz}$ [2]	9.0	11.4	-	dB
MSG	maximum stable gain	$f = 1.575\text{ GHz}$	-	20.5	-	dB
		$f = 2.4\text{ GHz}$	-	17.8	-	dB
		$f = 5.8\text{ GHz}$	-	15.4	-	dB
NF_{min}	minimum noise figure	$f = 1.575\text{ GHz}$	-	0.70	-	dB
		$f = 2.4\text{ GHz}$	-	0.80	-	dB
		$f = 5.8\text{ GHz}$	-	1.5	-	dB

[1] $I_{CC(tot)} = I_{CC} + I_{RF_OUT} + I_{R_BIAS}$.

[2] Guaranteed by design and characterization.

Table 8. ENABLE (pin 5) $-40\text{ }^{\circ}\text{C} \leq T_{\text{amb}} \leq +85\text{ }^{\circ}\text{C}$

V_{ENABLE} (V)	State
≤ 0.4	OFF
≥ 0.7	ON

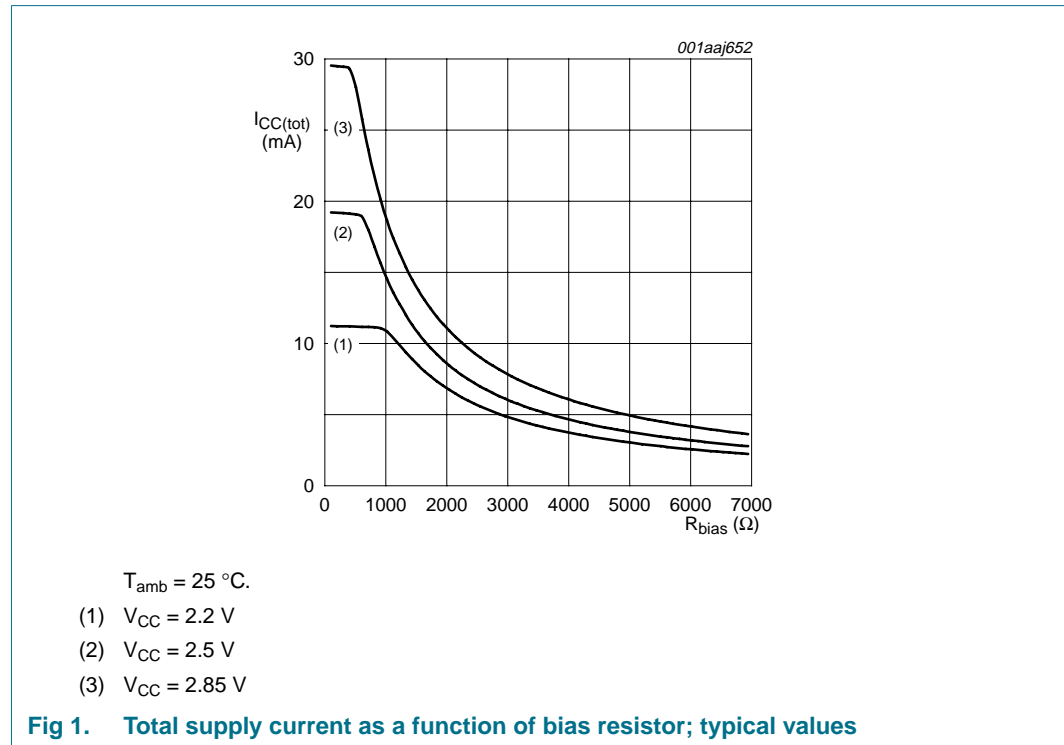

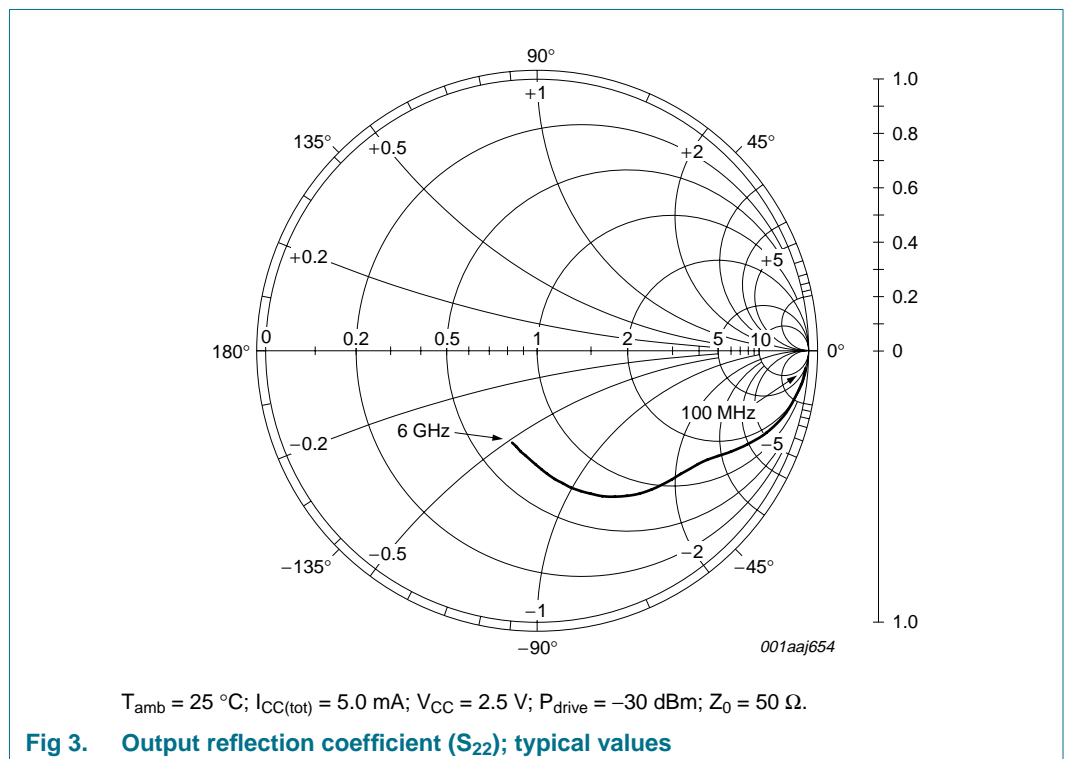
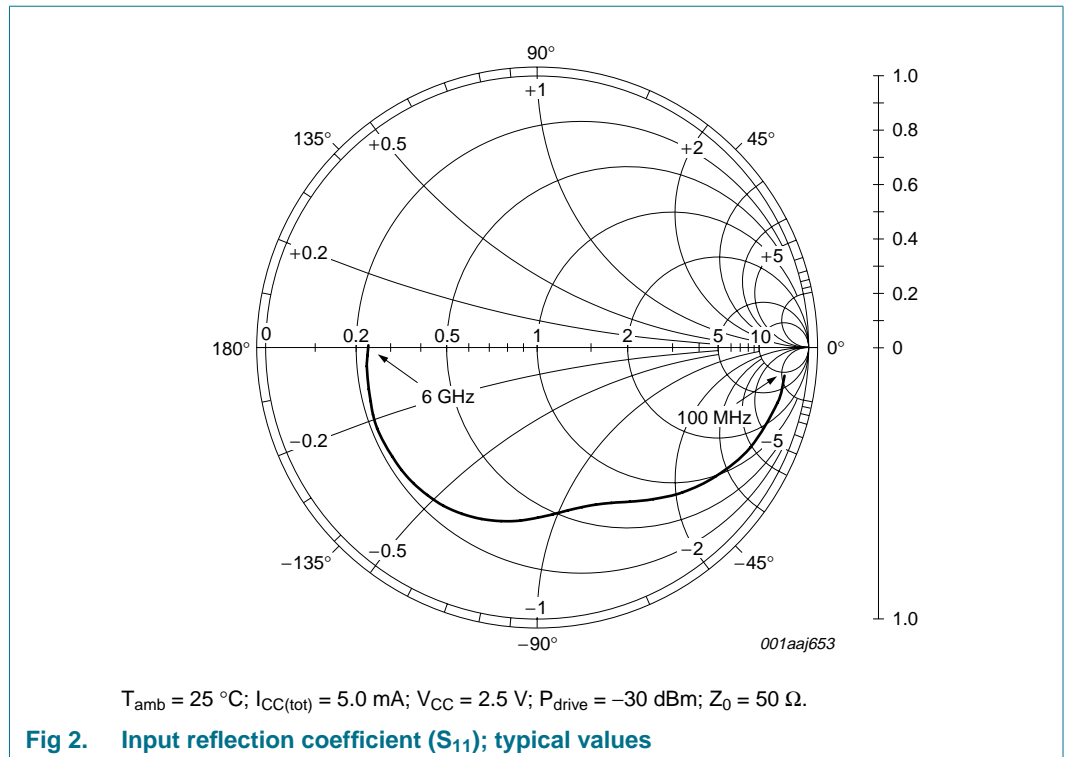

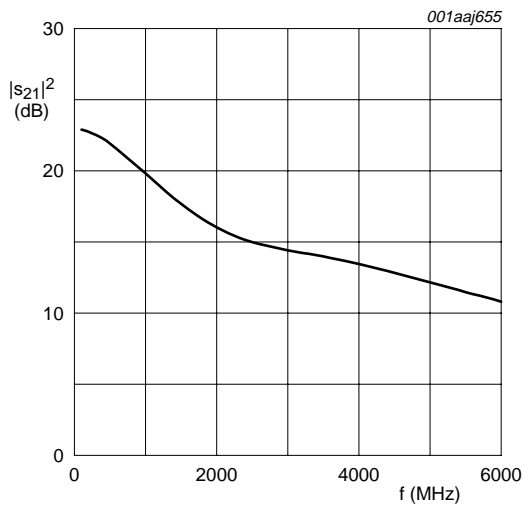

$T_{amb} = 25\text{ }^{\circ}\text{C}$; $I_{CC(tot)} = 5.0\text{ mA}$; $V_{CC} = 2.5\text{ V}$;
 $P_{drive} = -30\text{ dBm}$; $Z_0 = 50\text{ }\Omega$.

Fig 4. Insertion power gain ($|S_{21}|^2$) as a function of frequency; typical values

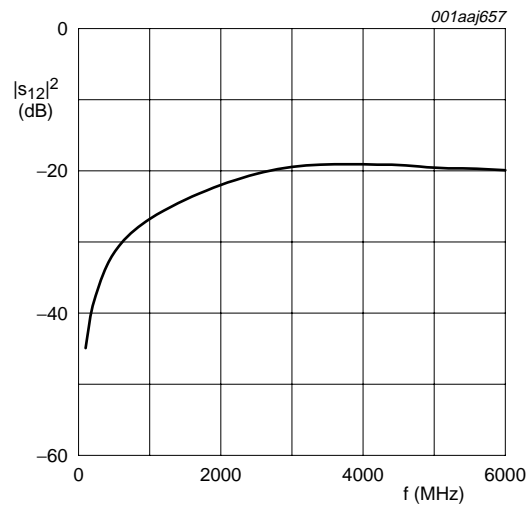

$T_{amb} = 25\text{ }^{\circ}\text{C}$; $I_{CC(tot)} = 5.0\text{ mA}$; $V_{CC} = 2.5\text{ V}$;
 $P_{drive} = -30\text{ dBm}$; $Z_0 = 50\text{ }\Omega$.

Fig 5. Isolation ($|S_{12}|^2$) as a function of frequency; typical values

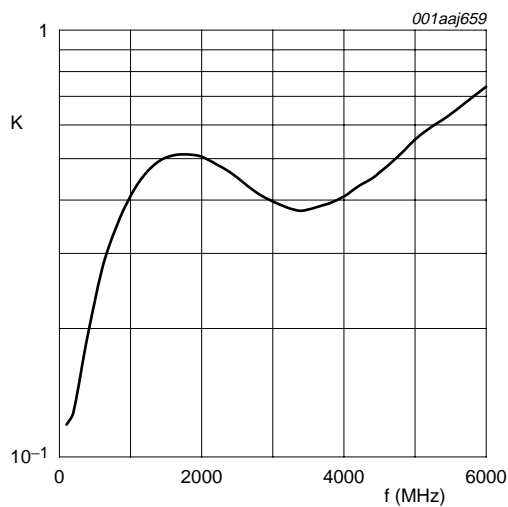

$T_{amb} = 25\text{ }^{\circ}\text{C}$; $I_{CC(tot)} = 5.0\text{ mA}$; $V_{CC} = 2.5\text{ V}$;
 $P_{drive} = -30\text{ dBm}$; $Z_0 = 50\text{ }\Omega$.

Fig 6. Rollet's stability factor as a function of frequency; typical values

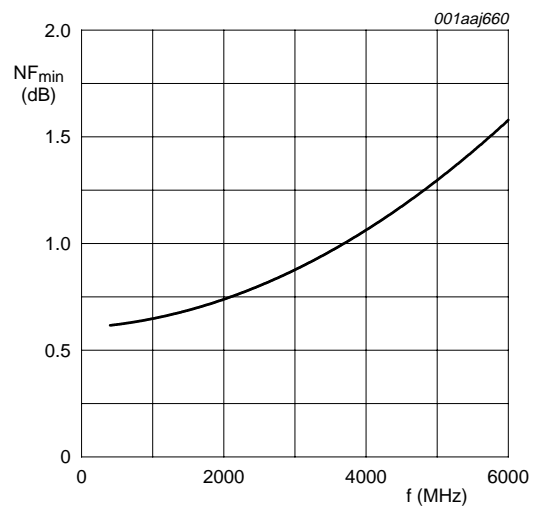

$T_{amb} = 25\text{ }^{\circ}\text{C}$; $I_{CC(tot)} = 5.0\text{ mA}$; $V_{CC} = 2.5\text{ V}$;
 $P_{drive} = -30\text{ dBm}$; $Z_0 = 50\text{ }\Omega$.

Fig 7. Minimum noise figure as a function of frequency; typical values

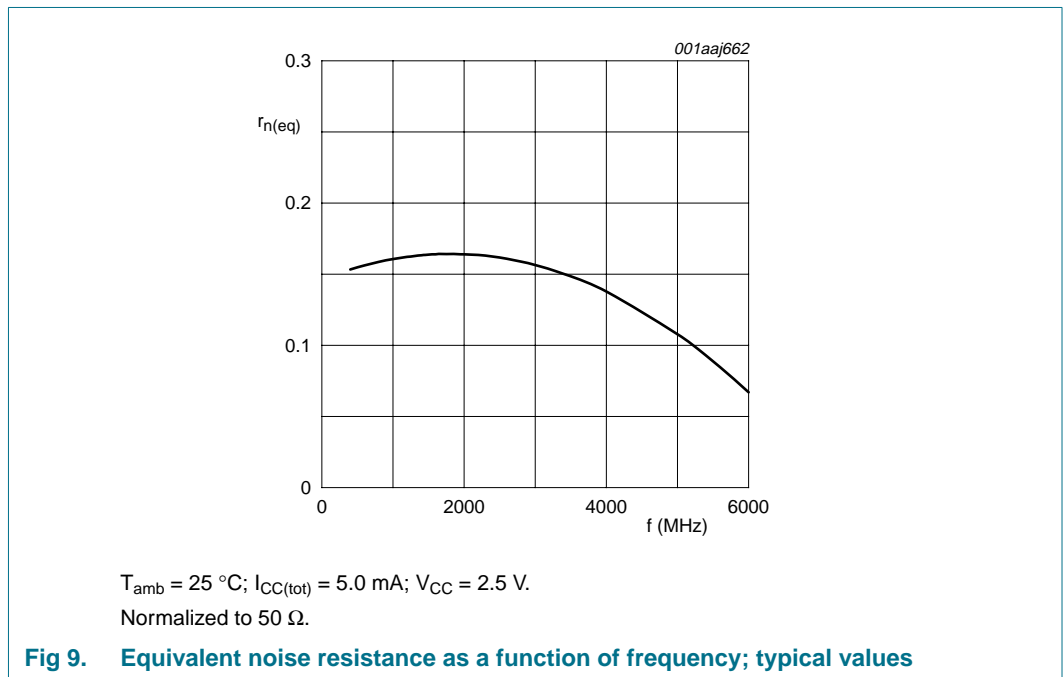
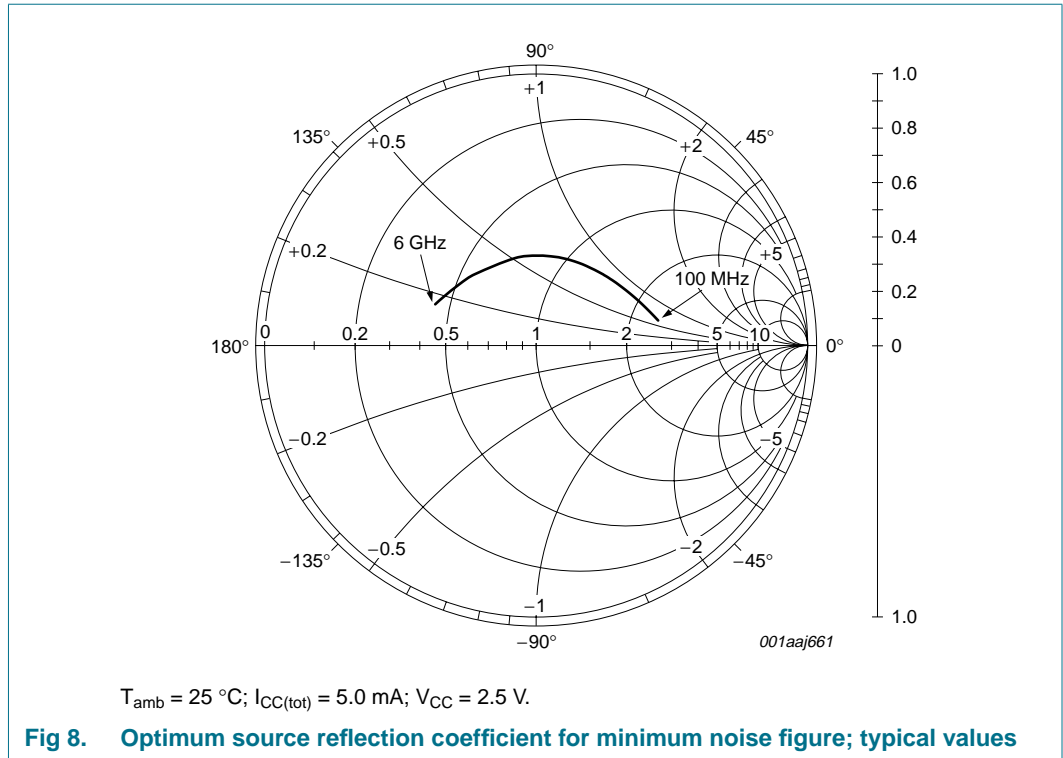

8. Application information GPS LNA

Other applications available. Please contact your local sales representative for more information. Application note(s) available on the NXP website.

8.1 Application circuit

In [Figure 10](#) the application diagram as supplied on the evaluation board is given.

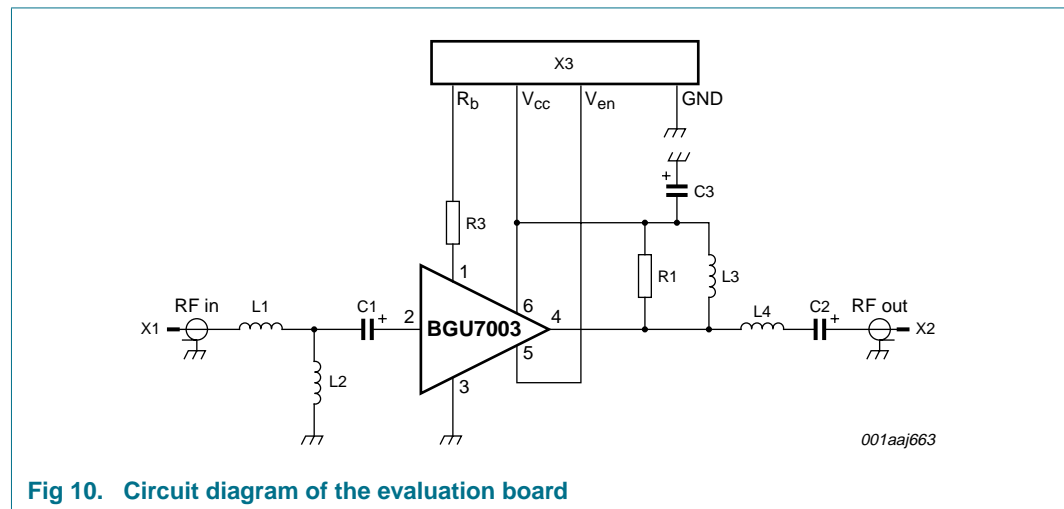

Fig 10. Circuit diagram of the evaluation board

Table 9. List of components

For circuit, see [Figure 10](#).

Component	Description	Value	Supplier name/type	Remarks
C1, C2	capacitor	100 pF [1]	MurataGRM1555	DC blocking
C3	capacitor	180 pF [1]	MurataGRM1555	decoupling
L1	inductor	2.7 nH [1]	Murata/LQW15A high quality factor, low series resistance	input matching
L2	inductor	33 nH [1]	Murata/LQW15A high quality factor, low series resistance	input matching
L3	inductor	3.9 nH [1]	Murata/LQG15HS	output matching / DC shunt
L4	inductor	4.7 nH [1]	Murata/LQG15HS	output matching
R1	resistor	180 Ω [1]		
R2	resistor	0 Ω [1]		bridge
R3	resistor	3300 Ω [1]		bias setting
X1, X2	SMA RF connector	-	Johnson, end launch SMA 142-0701-841	RF input / RF output
X3	DC header	-	Molex, PCB header, right angle, 1 row, 4 way 90121-0764	bias connector

[1] all capacitors, inductors and resistors have 0402 footprint.

8.2 Application board layout

Figure 11 shows the board layout with component identifications.

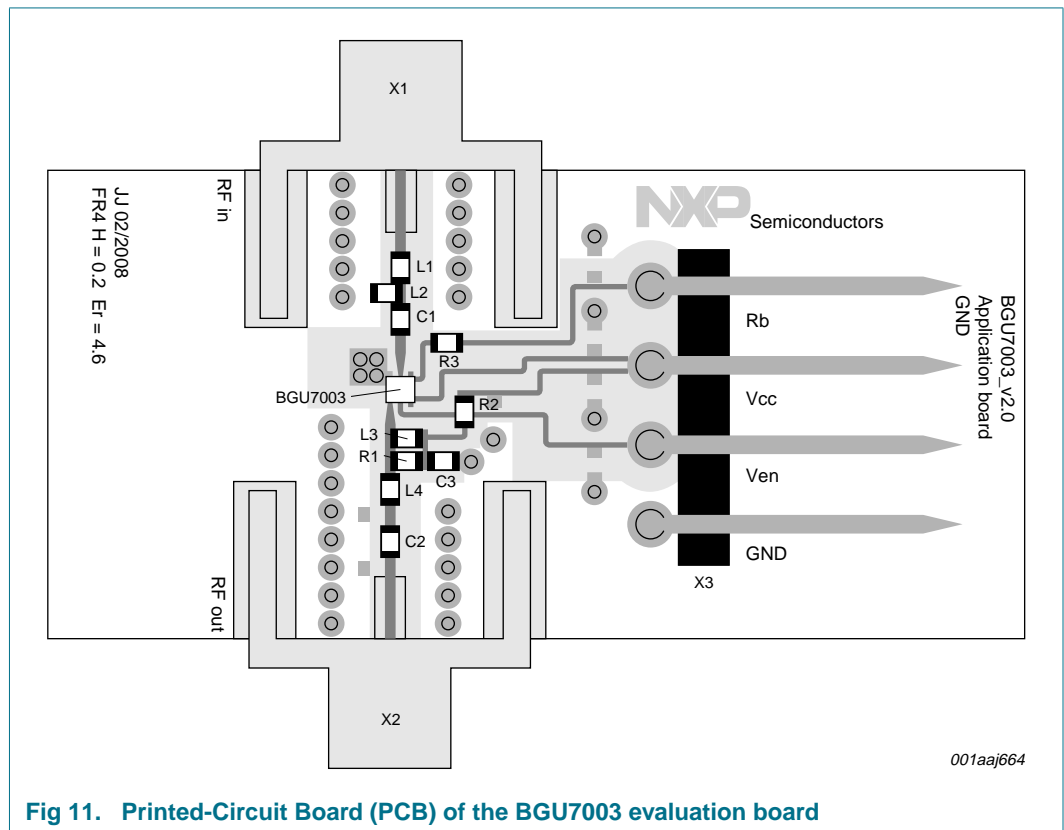

Fig 11. Printed-Circuit Board (PCB) of the BGU7003 evaluation board

8.3 Printed-Circuit Board

The material that has been used for the evaluation board is FR4 using the stack shown in Figure 12.

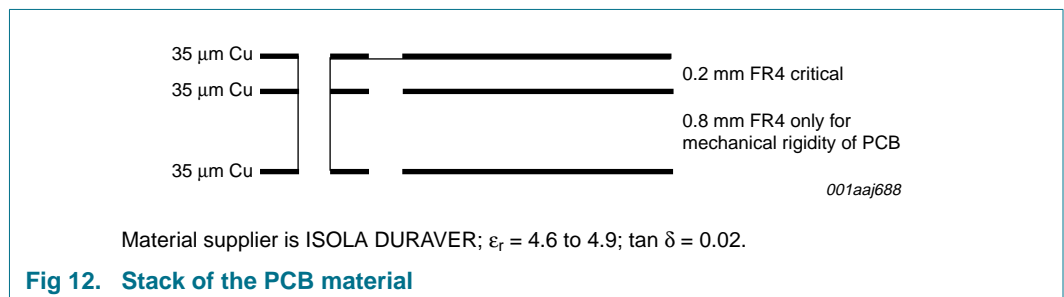

Fig 12. Stack of the PCB material

8.4 GPS evaluation board

Table 10. GPS application characteristics

$T_{amb} = 25\text{ }^{\circ}\text{C}$; $V_{CC} = 2.5\text{ V}$; $I_{CC(tot)} = 5.0\text{ mA}$; $f = 1.575\text{ GHz}$; $V_{ENABLE} \geq 0.7\text{ V}$; $Z_S = Z_L = 50\text{ }\Omega$ (input and output matched to $50\text{ }\Omega$) unless otherwise specified.

Symbol	Parameter	Conditions	Min	Typ	Max	Unit
$ S_{21} ^2$	Insertion power gain		-	18.3	-	dB
$ S_{11} ^2$	input return loss		-	-5.4	-	dB
$ S_{22} ^2$	output return loss		-	-19.5	-	dB
$ S_{12} ^2$	isolation		-	-24.6	-	dB
NF	noise figure		-	0.80	-	dB
$P_{i(1dB)}$	input power at 1 dB gain compression		-	-20.1	-	dBm
$P_{L(1dB)}$	output power at 1 dB gain compression		-	-2.8	-	dBm
$IP3_I$	input third-order intercept point	jammers at $f_1 = f + 138\text{ MHz}$ and $f_2 = f + 276\text{ MHz}$	-	-0.2	-	dBm
		$f_1 = f + 5\text{ MHz}$; $f_2 = f + 10\text{ MHz}$	-	-5.2	-	dBm

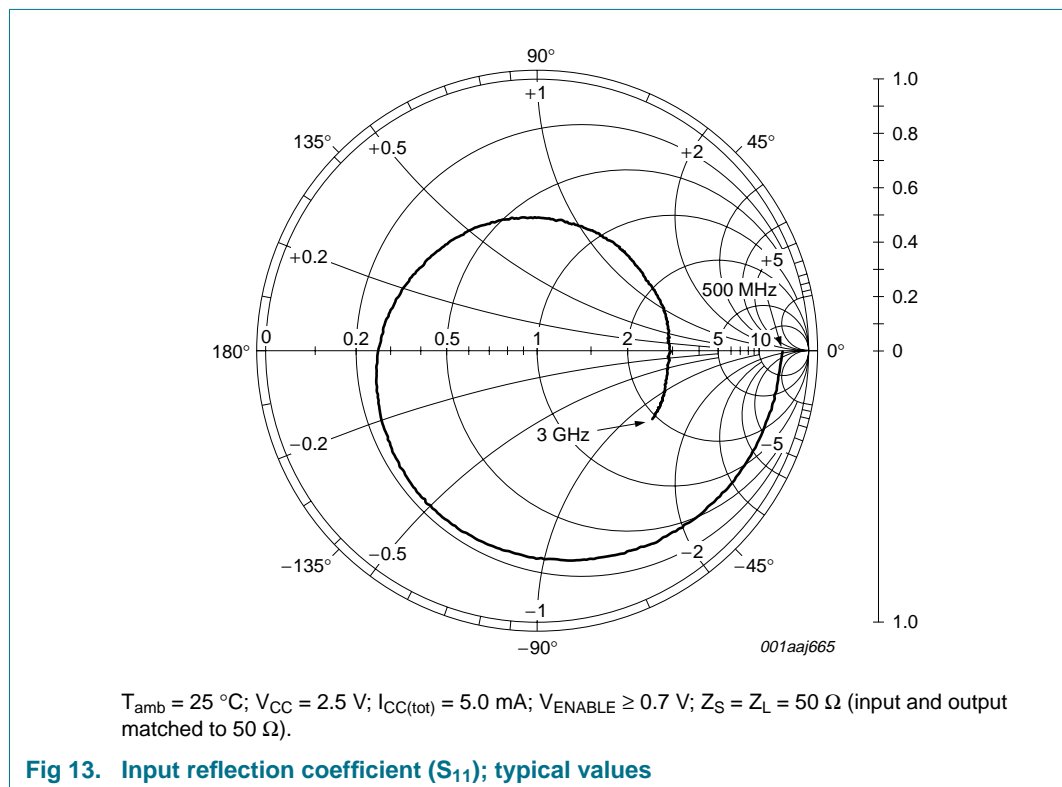

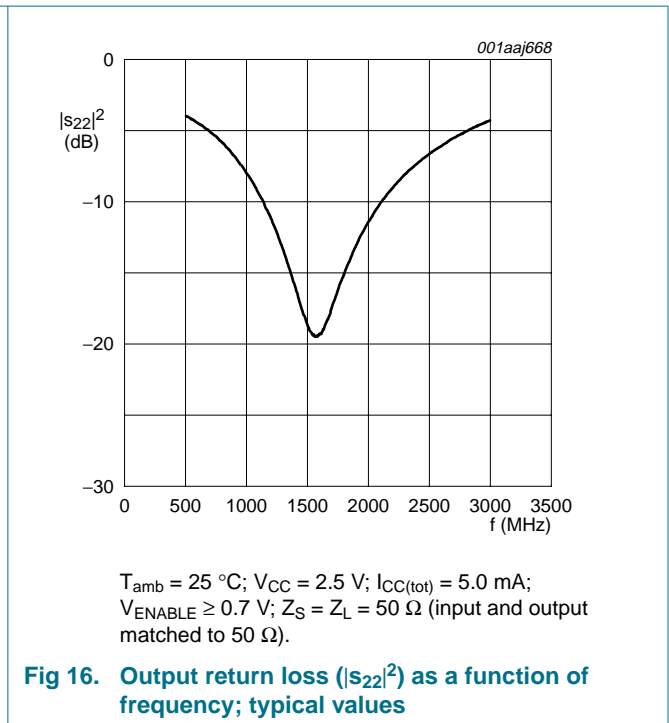
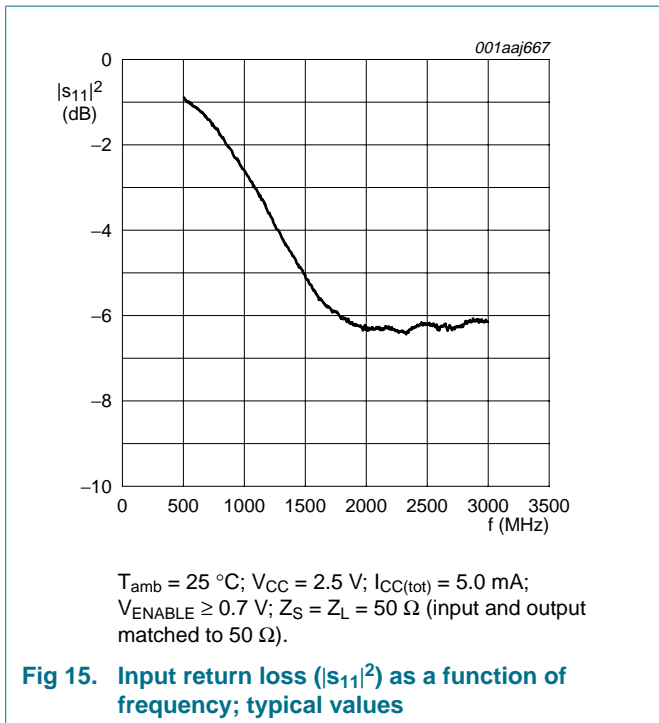
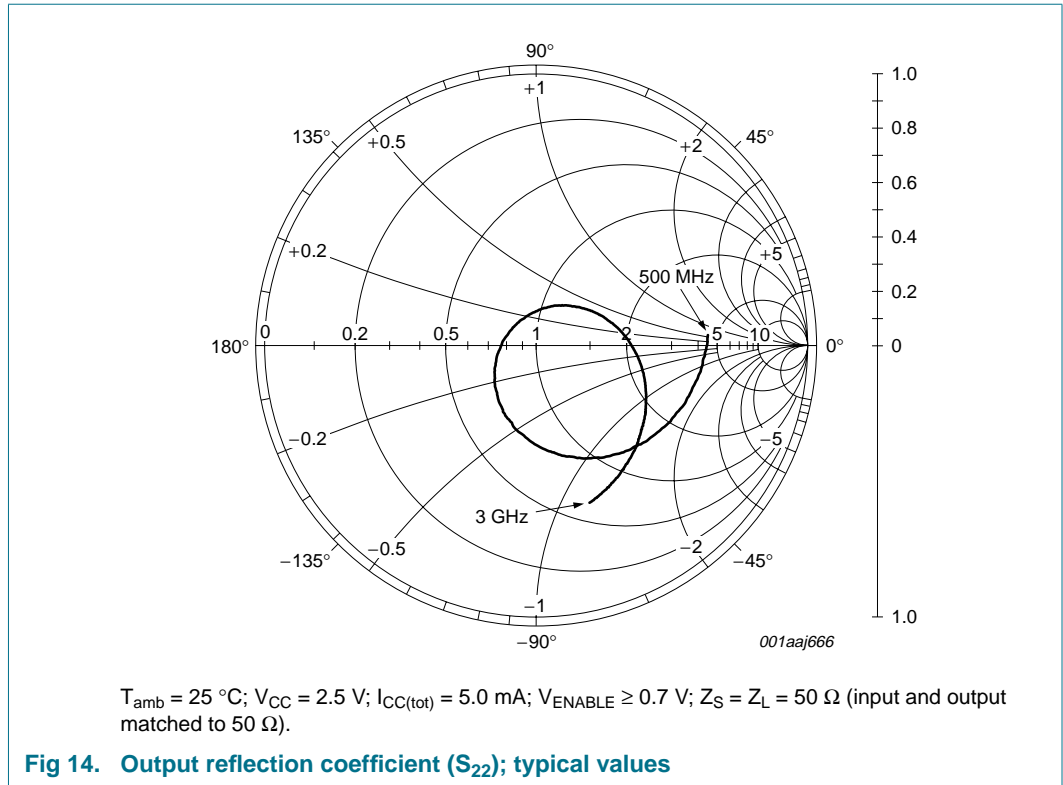

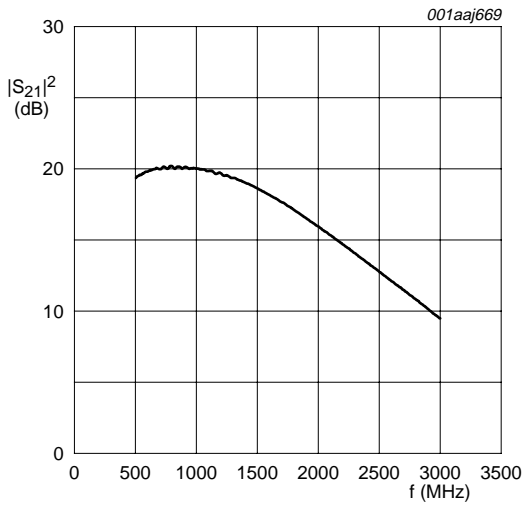

$T_{amb} = 25\text{ }^{\circ}\text{C}$; $V_{CC} = 2.5\text{ V}$; $I_{CC(tot)} = 5.0\text{ mA}$;
 $V_{ENABLE} \geq 0.7\text{ V}$; $Z_S = Z_L = 50\text{ }\Omega$ (input and output
 matched to $50\text{ }\Omega$).

Fig 17. Insertion power gain ($|S_{21}|^2$) as a function of frequency; typical values

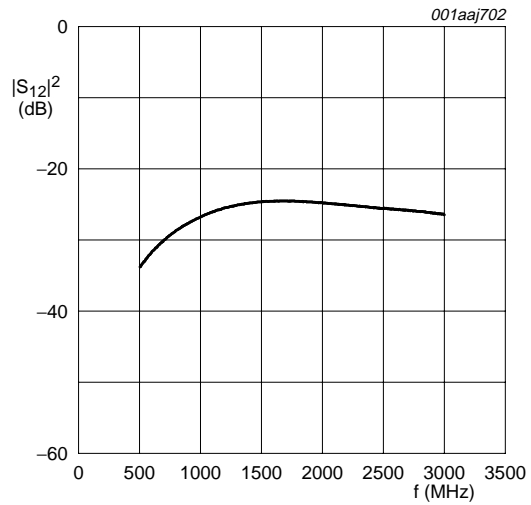

$T_{amb} = 25\text{ }^{\circ}\text{C}$; $V_{CC} = 2.5\text{ V}$; $I_{CC(tot)} = 5.0\text{ mA}$;
 $V_{ENABLE} \geq 0.7\text{ V}$; $Z_S = Z_L = 50\text{ }\Omega$ (input and output
 matched to $50\text{ }\Omega$).

Fig 18. Reverse Isolation ($|S_{12}|^2$) as a function of frequency; typical values

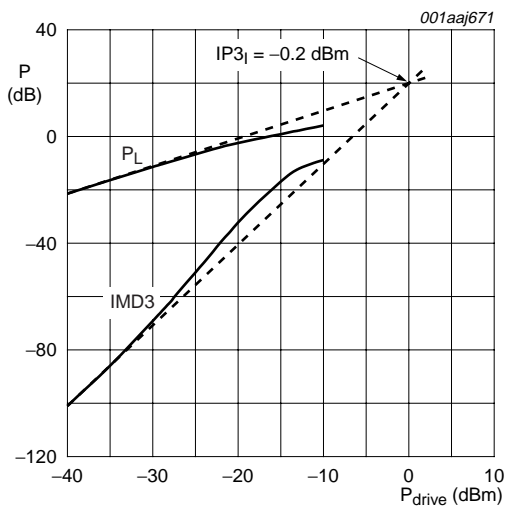

$T_{amb} = 25\text{ }^{\circ}\text{C}$; $V_{CC} = 2.5\text{ V}$; $I_{CC(tot)} = 5.0\text{ mA}$;
 $f = 1.575\text{ GHz}$; $f_1 = f + 138\text{ MHz}$; $f_2 = f + 276\text{ MHz}$;
 $V_{ENABLE} \geq 0.7\text{ V}$; $Z_S = Z_L = 50\text{ }\Omega$ (input and output
 matched to $50\text{ }\Omega$)

Fig 19. Load power and third order intermodulation distortion as function of drive power; typical values

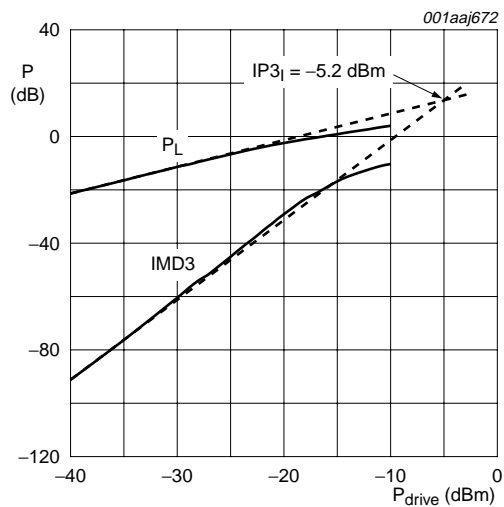

$T_{amb} = 25\text{ }^{\circ}\text{C}$; $V_{CC} = 2.5\text{ V}$; $I_{CC(tot)} = 5.0\text{ mA}$;
 $f = 1.575\text{ GHz}$; $f_1 = f + 5\text{ MHz}$; $f_2 = f + 10\text{ MHz}$;
 $V_{ENABLE} \geq 0.7\text{ V}$; $Z_S = Z_L = 50\text{ }\Omega$ (input and output
 matched to $50\text{ }\Omega$)

Fig 20. Load power and third order intermodulation distortion as function of drive power; typical values

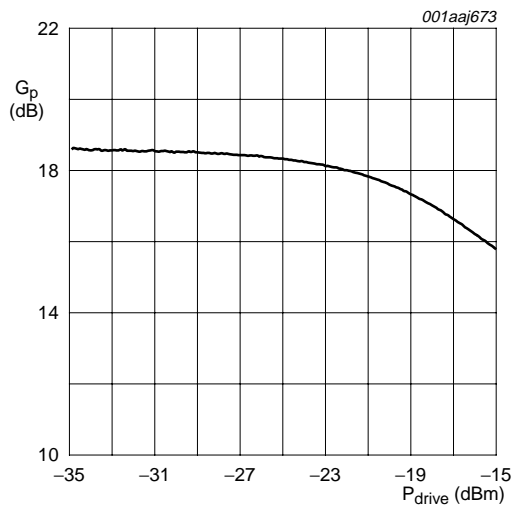

$T_{amb} = 25\text{ }^{\circ}\text{C}$; $V_{CC} = 2.5\text{ V}$; $I_{CC(tot)} = 5.0\text{ mA}$;
 $f = 1.575\text{ GHz}$; $V_{ENABLE} \geq 0.7\text{ V}$; $Z_S = Z_L = 50\text{ }\Omega$ (input
 and output matched to $50\text{ }\Omega$).

Fig 21. Power gain as a function of drive power; typical values

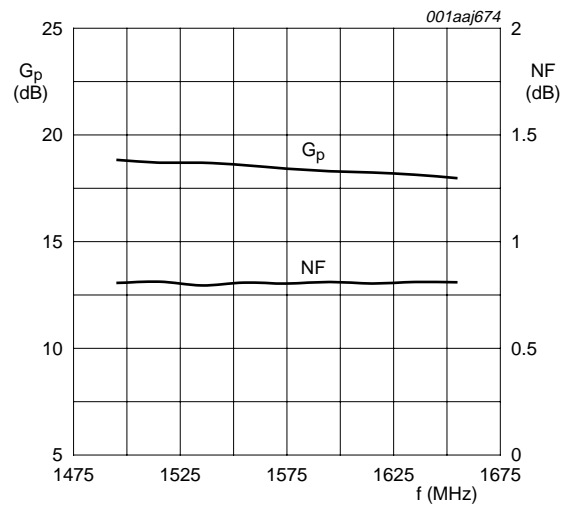

$T_{amb} = 25\text{ }^{\circ}\text{C}$; $V_{CC} = 2.5\text{ V}$; $I_{CC(tot)} = 5.0\text{ mA}$;
 $V_{ENABLE} \geq 0.7\text{ V}$; $Z_S = Z_L = 50\text{ }\Omega$ (input and output
 matched to $50\text{ }\Omega$).

Fig 22. Power gain and noise figure as function of frequency; typical values

9. Package outline

XSON6: plastic extremely thin small outline package; no leads; 6 terminals; body 1 x 1 x 0.5 mm

SOT891

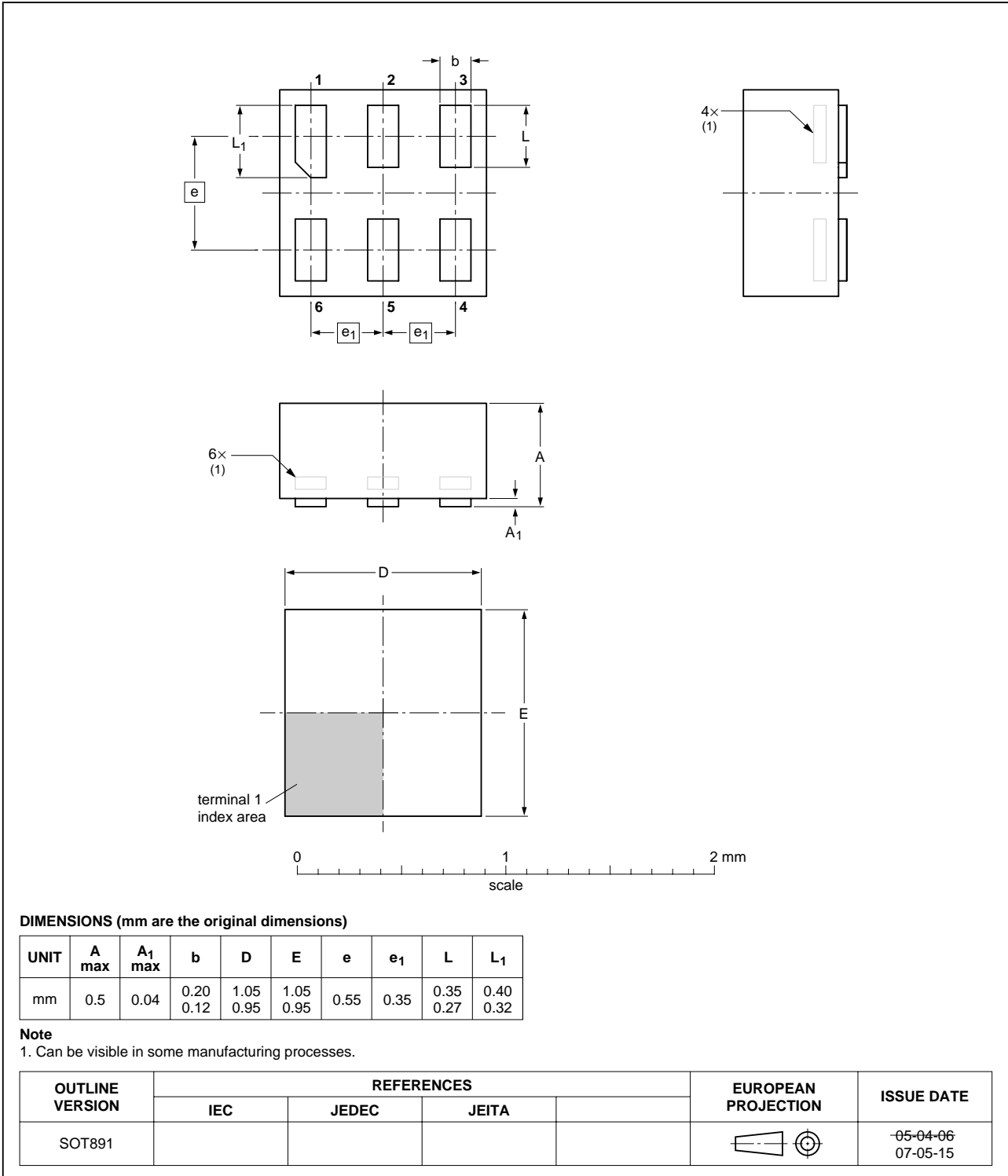
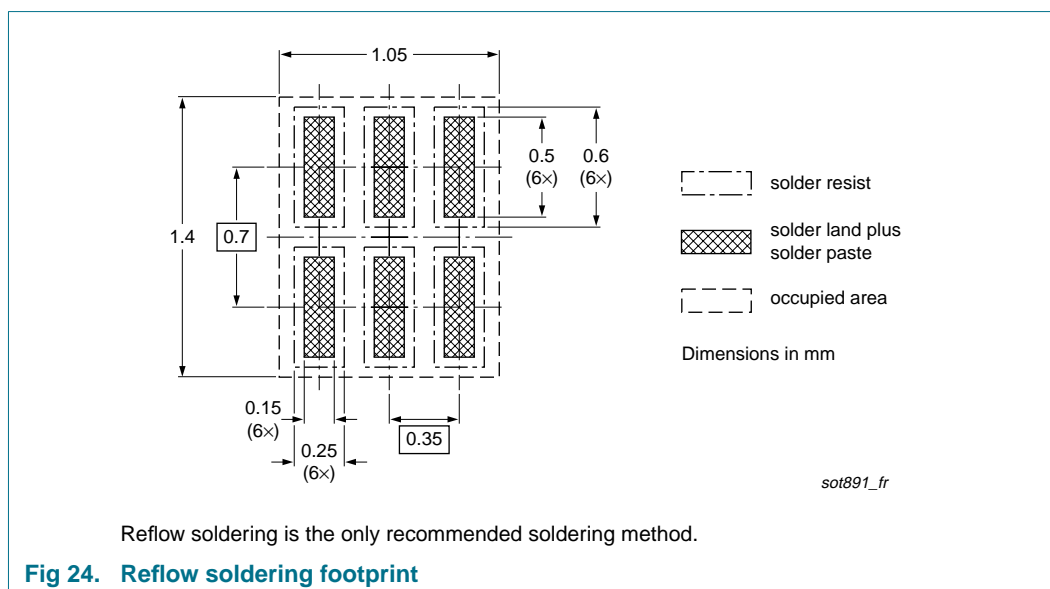

Fig 23. Package outline SOT891 (XSON6)

10. Soldering



11. Abbreviations

Table 11. Abbreviations

Acronym	Description
AC	Alternating Current
CDMA	Code Division Multiple Access
DC	Direct Current
FR4	Flame Retardant 4
GPS	Global Positioning System
LNA	Low-Noise Amplifier
MMIC	Monolithic Microwave Integrated Circuit
RF	Radio Frequency
SiGe:C	Silicon Germanium Carbon
SMA	SubMiniature version A
WLAN	Wireless Local Area Network

12. Revision history

Table 12. Revision history

Document ID	Release date	Data sheet status	Change notice	Supersedes
BGU7003_1	20090302	Product data sheet	-	-

13. Legal information

13.1 Data sheet status

Document status ^{[1][2]}	Product status ^[3]	Definition
Objective [short] data sheet	Development	This document contains data from the objective specification for product development.
Preliminary [short] data sheet	Qualification	This document contains data from the preliminary specification.
Product [short] data sheet	Production	This document contains the product specification.

[1] Please consult the most recently issued document before initiating or completing a design.

[2] The term 'short data sheet' is explained in section "Definitions".

[3] The product status of device(s) described in this document may have changed since this document was published and may differ in case of multiple devices. The latest product status information is available on the Internet at URL <http://www.nxp.com>.

13.2 Definitions

Draft — The document is a draft version only. The content is still under internal review and subject to formal approval, which may result in modifications or additions. NXP Semiconductors does not give any representations or warranties as to the accuracy or completeness of information included herein and shall have no liability for the consequences of use of such information.

Short data sheet — A short data sheet is an extract from a full data sheet with the same product type number(s) and title. A short data sheet is intended for quick reference only and should not be relied upon to contain detailed and full information. For detailed and full information see the relevant full data sheet, which is available on request via the local NXP Semiconductors sales office. In case of any inconsistency or conflict with the short data sheet, the full data sheet shall prevail.

13.3 Disclaimers

General — Information in this document is believed to be accurate and reliable. However, NXP Semiconductors does not give any representations or warranties, expressed or implied, as to the accuracy or completeness of such information and shall have no liability for the consequences of use of such information.

Right to make changes — NXP Semiconductors reserves the right to make changes to information published in this document, including without limitation specifications and product descriptions, at any time and without notice. This document supersedes and replaces all information supplied prior to the publication hereof.

Suitability for use — NXP Semiconductors products are not designed, authorized or warranted to be suitable for use in medical, military, aircraft, space or life support equipment, nor in applications where failure or malfunction of an NXP Semiconductors product can reasonably be expected to result in personal injury, death or severe property or environmental

damage. NXP Semiconductors accepts no liability for inclusion and/or use of NXP Semiconductors products in such equipment or applications and therefore such inclusion and/or use is at the customer's own risk.

Applications — Applications that are described herein for any of these products are for illustrative purposes only. NXP Semiconductors makes no representation or warranty that such applications will be suitable for the specified use without further testing or modification.

Limiting values — Stress above one or more limiting values (as defined in the Absolute Maximum Ratings System of IEC 60134) may cause permanent damage to the device. Limiting values are stress ratings only and operation of the device at these or any other conditions above those given in the Characteristics sections of this document is not implied. Exposure to limiting values for extended periods may affect device reliability.

Terms and conditions of sale — NXP Semiconductors products are sold subject to the general terms and conditions of commercial sale, as published at <http://www.nxp.com/profile/terms>, including those pertaining to warranty, intellectual property rights infringement and limitation of liability, unless explicitly otherwise agreed to in writing by NXP Semiconductors. In case of any inconsistency or conflict between information in this document and such terms and conditions, the latter will prevail.

No offer to sell or license — Nothing in this document may be interpreted or construed as an offer to sell products that is open for acceptance or the grant, conveyance or implication of any license under any copyrights, patents or other industrial or intellectual property rights.

Quick reference data — The Quick reference data is an extract of the product data given in the Limiting values and Characteristics sections of this document, and as such is not complete, exhaustive or legally binding.

13.4 Trademarks

Notice: All referenced brands, product names, service names and trademarks are the property of their respective owners.

14. Contact information

For more information, please visit: <http://www.nxp.com>

For sales office addresses, please send an email to: salesaddresses@nxp.com

15. Contents

1	Product profile	1
1.1	General description	1
1.2	Features	1
1.3	Applications	1
1.4	Quick reference data	2
2	Pinning information	2
3	Ordering information	2
4	Marking	2
5	Limiting values	3
6	Thermal characteristics	3
7	Characteristics	3
8	Application information GPS LNA	7
8.1	Application circuit	8
8.2	Application board layout	9
8.3	Printed-Circuit Board	9
8.4	GPS evaluation board	10
9	Package outline	14
10	Soldering	15
11	Abbreviations	15
12	Revision history	15
13	Legal information	16
13.1	Data sheet status	16
13.2	Definitions	16
13.3	Disclaimers	16
13.4	Trademarks	16
14	Contact information	16
15	Contents	17

Please be aware that important notices concerning this document and the product(s) described herein, have been included in section 'Legal information'.

founded by

PHILIPS

© NXP B.V. 2009.

All rights reserved.

For more information, please visit: <http://www.nxp.com>

For sales office addresses, please send an email to: salesaddresses@nxp.com

Date of release: 2 March 2009

Document identifier: BGU7003_1