





Messrs.					
Product Specification	Model:	MTF-TQ35SP721-AV	Rev. No.	Issued Date.	Page.
			A	Aug. 09, 07	1 / 38

**LIQUID CRYSTAL DISPLAY MODULE**  
**MODEL: MTF-TQ35SP721-AV**  
**Customer's No.:**

Acceptance

*Microtips Technology Inc.*  
*12F. No.31 Lane 169, Kang Ning St.,*  
*Hsi-Chih, Taipei Hsien, Taiwan*  
*FAX: 886-2-26958625*

Approved and Checked by

Approved by	Checked by		Made by
			



*Microtips Technology Inc.*



Messrs.					
Product Specification	Model:	MTF-TQ35SP721-AV	Rev. No.	Issued Date.	Page.
			A	Aug. 09, 07	3 / 38

## Contents

<b>1. GENERAL DESCRIPTION AND FEATURES</b> .....	5
1.1 Features .....	5
1.2 General Specifications.....	5
<b>2. BLOCK DIAGRAM</b> .....	6
2.1 TFT-LCD Module (Interface System Structure) with Back Light Unit.....	6
<b>3. INPUT TERMINAL PIN ASSIGNMENT</b> .....	7
3.1 CN1 Pin Assignment (LCD).....	7
<b>4. OPTICAL CHARACTERISTICS</b> .....	9
<b>5. ABSOLUTE MAXIMUM RATINGS</b> .....	12
5.1 Absolute Ratings of Environment .....	12
5.2 Electrical Absolute Rating.....	13
<b>6. ELECTRICAL CHARACTERISTICS</b> .....	14
6.1 DC Electrical Characteristics .....	14
6.2 AC Characteristics.....	15
<b>7. OPERATION SPECIFICATIONS</b> .....	18
7.1 Timing Controller Timing Chart .....	18
7.2 SPI TIMING CHARACTERISTICS .....	23
<b>8. COMMAND LIST &amp; INSTRUCTION DESCRIPTIONS</b> .....	24
8.1 Command List .....	24
8.2 Instruction Descriptions .....	24
8.3 Power ON/OFF sequence.....	24
<b>9. BACKLIGHT SPECIFICATIONS</b> .....	25
9.1 Absolute Maximum Ratings.....	25
9.2 Electrical/Operating Characteristics.....	25
9.3 Electrical Circuit of Backlight.....	25
<b>10. BASIC DISPLAY COLOR AND GRAY SCALE</b> .....	26
<b>11. QUALITY STANDARD FOR LCD</b> .....	27
11.1 Objective .....	27
11.2 Scope .....	27
11.3 Inspection specification.....	29
<b>12. RELIABILITY CONDITION FOR LCD</b> .....	32
12.1 LCM Reliability Test.....	32
12.2 Touch panel Reliability .....	33
<b>13. PRECAUTIONS</b> .....	34
13.1 Operation.....	34
13.2 Safety.....	34
13.3 Handling .....	34



Messrs.					
Product Specification	Model:	MTF-TQ35SP721-AV	Rev. No.	Issued Date.	Page.
			A	Aug. 09, 07	4 / 38

13.4 Static electricity .....	36
13.5 Storage.....	36
13.6 Cleaning .....	36
13.7 Waste .....	36
<b>14. WARRANTY .....</b>	<b>37</b>
<b>15. DIMENSIONAL OUTLINES .....</b>	<b>37</b>



Messrs.					
Product Specification	Model:	MTF-TQ35SP721-AV	Rev. No.	Issued Date.	Page.
			A	Aug. 09, 07	5 / 38

## 1. GENERAL DESCRIPTION AND FEATURES

MTF-TQ35SP721-AV is a TM (Transmissive) type color active matrix TFT (Thin Film Transistor) liquid crystal display (LCD) that uses amorphous silicon TFT as a switching devices. This model is composed of a TFT-LCD module, a driver circuit, touch panel and a back-light unit. The resolution of a 3.5" contains 320RGBx240 dots and can display up to 16.7M colors. The following table described the features of MTF-TQ35SP721-AV.

### 1.1 Features

- Support 24-bit data (RGB) or CCIR656/CCIR601 8 bit format or 8 bit serial RGB.
- Support Low power control mode (stand by mole)
- UP and down scan capability

### 1.2 General Specifications

Item	Specification	Unit	Note
Screen Size	3.5" diagonal	inch	--
Display Resolution	320 x RGB x 240	Dot	--
Dot Pitch	0.073 (W) x 0.219 (H)	mm	--
Active Area	70.08 (W) x 52.56 (H)	mm	--
Outline Dimension	77.8 (W) x 64.5 (H) x 4.1 (T), Including touch panel, but not including FPCB	mm	--
Display Mode	Normally white/Transmissive	--	--
Pixel Arrangement	RGB-Strip	--	--
Surface Treatment	Anti-glare (AG)	--	--
weight	39	g	--
Viewing Direction	6 o'clock	--	--
Input Interface	Digital 24-bits parallel RGB	--	--
Color Garmut	NTSC 50%	--	--
Driver IC	Himax HX8615 & HX8218	--	--

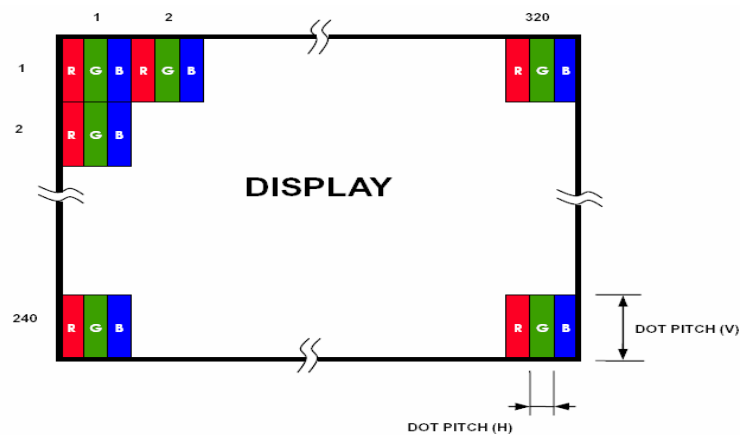

Pixel Arrangement



*Microtips Technology Inc.*

Messrs.					
Product Specification	Model:	MTF-TQ35SP721-AV	Rev. No.	Issued Date.	Page.
			A	Aug. 09, 07	6 / 38

## 2. BLOCK DIAGRAM

### 2.1 TFT-LCD Module (Interface System Structure) with Back Light Unit

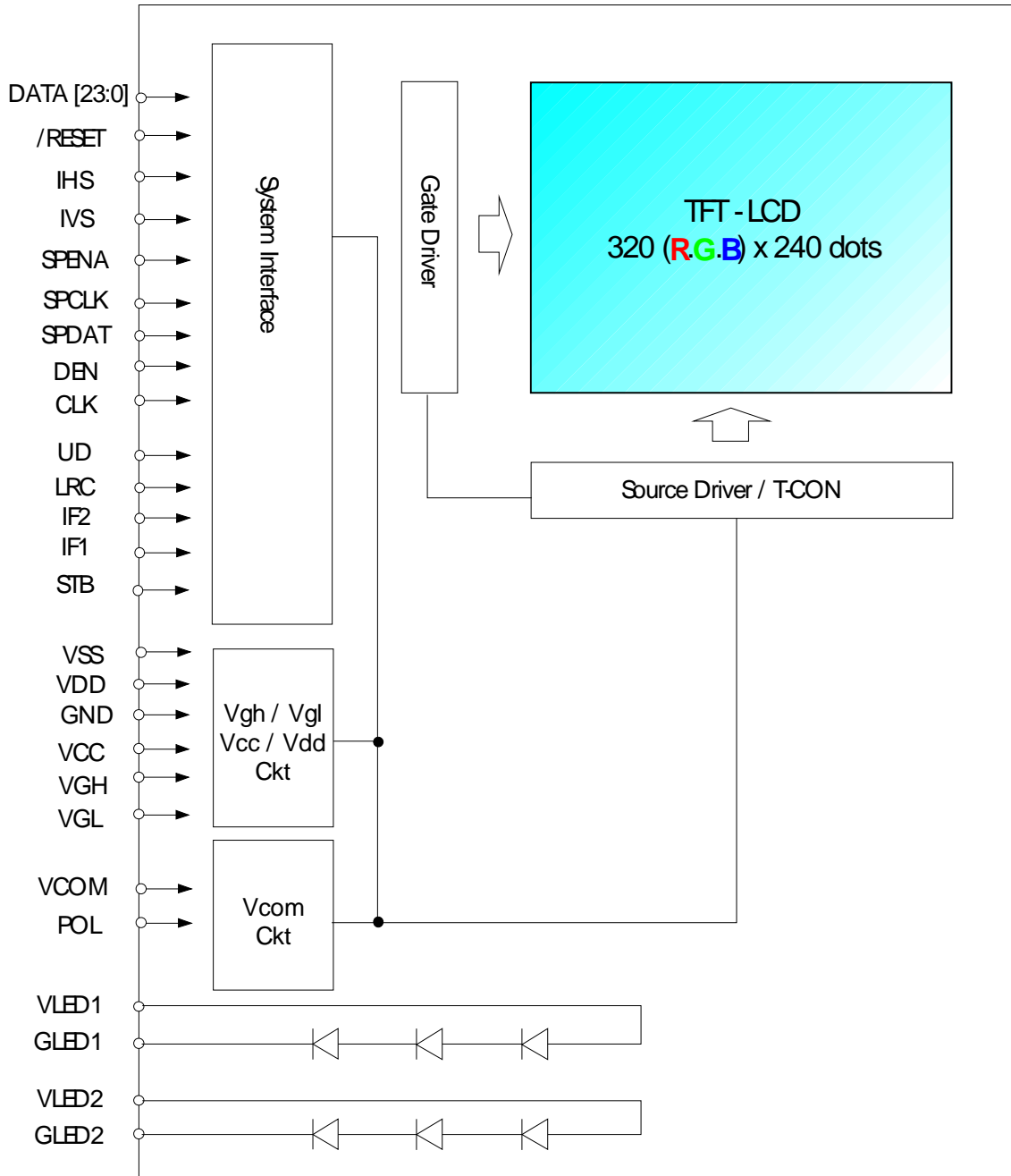

Messrs.					
Product Specification	Model:	MTF-TQ35SP721-AV	Rev. No.	Issued Date.	Page.
			A	Aug. 09, 07	7 / 38

### 3. INPUT TERMINAL PIN ASSIGNMENT

#### 3.1 CN1 Pin Assignment (LCD)

Pin No.	Symbol	I/O	Function	Remark
1	LED K1	I	Backlight LED Ground	
2	LED K2	I	Backlight LED Ground	
3	LED A1	I	Backlight LED Power (10.2V/20mA)	
4	LED A2	I	Backlight LED Power (10.2V/20mA)	
5	N/C	--	Not Connection	
6	RESET	I	Hardware Reset	
7	POL	O	Polarity Signal Connect to Vcom driving circuit	Note 1
8	N/C or Y1 (Top)	I	No connection (for MTF-TQ35SN721-AV) or Y1 (Top) (for for MTF-TQ35SP721-AV)	
9	N/C or X1 (Right)	I	No connection (for MTF-TQ35SN721-AV) or X1 (Right) (for for MTF-TQ35SP721-AV)	
10	N/C or Y2 (Bottom)	I	No connection (for MTF-TQ35SN721-AV) or Y2 (Bottom) (for for MTF-TQ35SP721-AV)	
11	N/C or X2 (Left)	I	No connection (for MTF-TQ35SN721-AV) or X2 (Left) (for for MTF-TQ35SP721-AV)	
12	B0	I	Blue Data Bit 0	
13	B1	I	Blue Data Bit 1	
14	B2	I	Blue Data Bit 2	
15	B3	I	Blue Data Bit 3	
16	B4	I	Blue Data Bit 4	
17	B5	I	Blue Data Bit 5	
18	B6	I	Blue Data Bit 6	
19	B7	I	Blue Data Bit 7	
20	G0	I	Green Data Bit0	
21	G1	I	Green Data Bit1	
22	G2	I	Green Data Bit2	
23	G3	I	Green Data Bit3	
24	G4	I	Green Data Bit4	
25	G5	I	Green Data Bit5	
26	G6	I	Green Data Bit6	
27	G7	I	Green Data Bit7	
28	R0	I	Red Data Bit0	
29	R1	I	Red Data Bit1	



Messrs.					
Product Specification	Model:	MTF-TQ35SP721-AV	Rev. No.	Issued Date.	Page.
			A	Aug. 09, 07	8 / 38

30	R2	I	Red Data Bit2	
31	R3	I	Red Data Bit3	
32	R4	I	Red Data Bit4	
33	R5	I	Red Data Bit5	
34	R6	I	Red Data Bit6	
35	R7	I	Red Data Bit7	
36	H <sub>SYNC</sub>	I	Horizontal Sync Input	
37	V <sub>SYNC</sub>	I	Vertical Sync Input	
38	D <sub>CLK</sub>	I	Dot Data Clock	
39	V <sub>DD</sub>	I	Analog Power	
40	V <sub>DD</sub>	I	Analog Power	
41	V <sub>CC</sub>	I	Digital Power	
42	V <sub>CC</sub>	I	Digital Power	
43	SP <sub>ENA</sub>	I	SPI Interface Data Enable Signal	
44	N/C	--	Not Connection	
45	V <sub>GL</sub>	I	Gate OFF Power	
46	N/C	--	Not Connection	
47	V <sub>GH</sub>	I	Gate ON Power	
48	NC	--	Not Connection	
49	SP <sub>CLK</sub>	I	SPI Interface Data Clock	
50	SP <sub>DAT</sub>	I	SPI Interface Data	
51	VCOM	I	Driving Input	Note 1
52	DEN	I	Data Enable Input	
53	AGND	I	Analog Ground	
54	DGND	I	Digital Ground	

Note :

1. The polarity of Vcom (Pin 3) should be generated from POL (M) (Pin 13).



*Microtips Technology Inc.*



Messrs.					
Product Specification	Model:	MTF-TQ35SP721-AV	Rev. No.	Issued Date.	Page.
			A	Aug. 09, 07	9 / 38

#### 4. OPTICAL CHARACTERISTICS

The following items are measured under stable conditions. The optical characteristics should be measured in a dark room or equivalent state with the methods shown in Note (1).

(Ta=25(2°C , Vcc = VCI=3.3V, If40mA)

Item		Symbol	Condition	Min	Type	Max	Unit	Note
Brightness	MTF-TQ35SN721-AV	Br	--	200	250	--	cd/m <sup>2</sup>	Note2
	MTF-TQ35SP721-AV	Br	--	160	200	--	cd/m <sup>2</sup>	
Response time	Rise	t <sub>R</sub>	θ=0°	--	15	30	ms	Note3
	Fall	t <sub>F</sub>		--	35	50	ms	
Contrast ratio		CR	At optimized viewing angle	--	200	--	--	Note4
Color Chromaticity	Red	R <sub>X</sub>	θ=0° Normal Viewing Angle	0.566	0.596	0.626	--	--
		R <sub>Y</sub>		0.315	0.345	0.375		
	Green	G <sub>X</sub>		0.287	0.317	0.347	--	
		G <sub>Y</sub>		0.542	0.572	0.602		
	Blue	B <sub>X</sub>		0.106	0.136	0.166	--	
		B <sub>Y</sub>		0.147	0.177	0.207		
	White	W <sub>X</sub>		0.284	0.314	0.344	--	
		W <sub>Y</sub>		0.330	0.360	0.390		
Viewing Angle (6H)	Hor.	θ <sub>R</sub>	CR≥10	50	60	--	Degree	Note5
		θ <sub>L</sub>		50	60	--		
	Ver.	θ <sub>B</sub>		40	50	--		
		θ <sub>F</sub>		50	60	--		
LED Life time	±25°C	LL	IL=20mA	--	40,000	--	hour	Note6

Note1 : Definition of Transmittance (T%)

$$T = \text{Aperture Ratio (TFT)} \times W_Y \text{ (CF)}$$

Note2 : Test Equipment Setup

After stabilizing and leaving the panel alone at a given temperature for 30 min., the measurement should be executed. Measurement should be executed in a stable, windless, and dark room. 30 min. after lighting the back-light. This should be measured in the center of screen.

Back-Light current: 20\*2=40mA

Environment condition : 1. Ta=25±2°C

2. illuminations ≤ 1 lux



*Microtips Technology Inc.*

Messrs.					
Product Specification	Model:	MTF-TQ35SP721-AV	Rev. No.	Issued Date.	Page.
			A	Aug. 09, 07	10 / 38

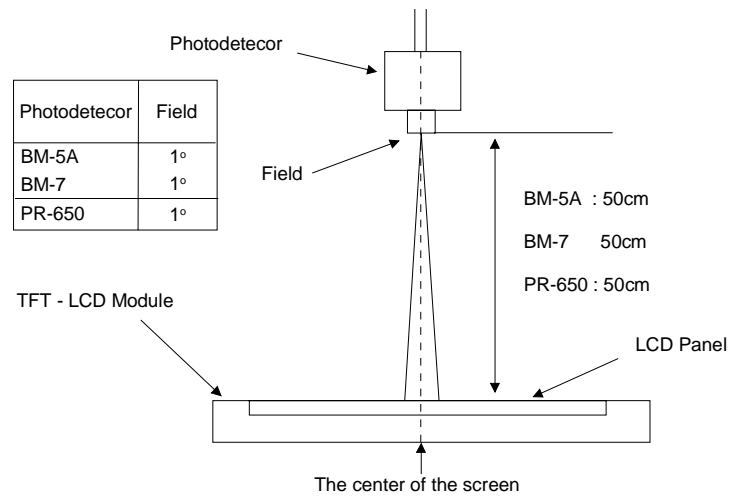

Note3 : Definition of response time: TR and TF

The response time is defined as the following figure and shall be measured by switching the input signal for “black” and “white”.

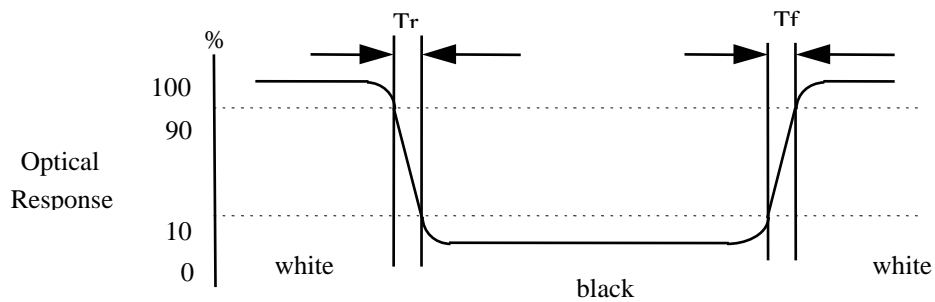

Note4 : Definition of contrast ratio:

$$\text{Contrast Ratio (CR)} = \frac{\text{Brightness measured when LCD is at "white state"}}{\text{Brightness measured when LCD is at "black state"}}$$

Note5 : Measured at the center area of the panel when all the input terminals of LCD panel are electrically opened.



*Microtips Technology Inc.*

Messrs.					
Product Specification	Model:	MTF-TQ35SP721-AV	Rev. No.	Issued Date.	Page.
			A	Aug. 09, 07	11 / 38

View Angle

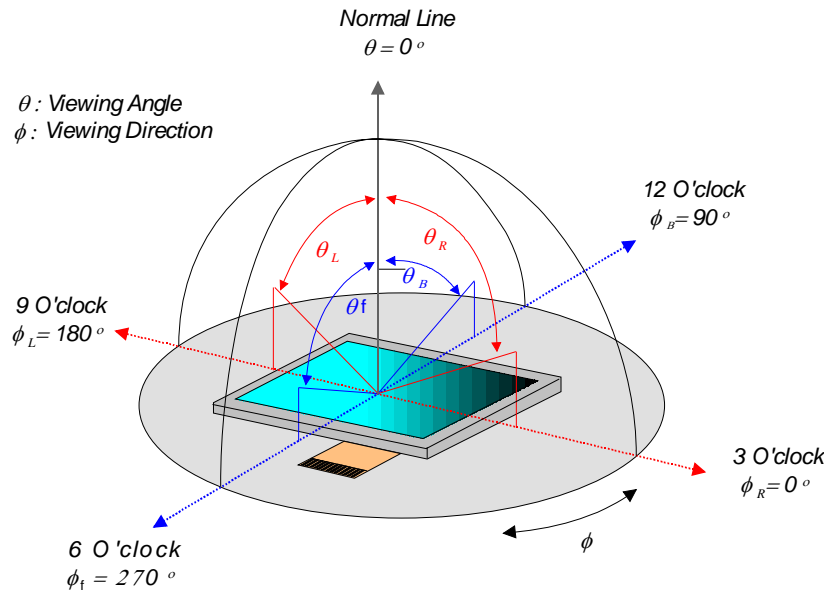

Note6 : This is the reference value. The white-LED life time is defined as a time when brightness not to become under 50% of the original value (at Ta=25°C)



*Microtips Technology Inc.*

Messrs.					
Product Specification	Model:	MTF-TQ35SP721-AV	Rev. No.	Issued Date.	Page.
			A	Aug. 09, 07	12 / 38

## 5. ABSOLUTE MAXIMUM RATINGS

### 5.1 Absolute Ratings of Environment

If the operating condition exceeds the following absolute maximum ratings, the TFT LCD module may be damaged permanently.

(Ta=25(2°C, VSS=GND=0)

Item	Symbol	Min.	Max.	Unit	Note
Storage temperature	TSTG	-30	80	°C	(1)
Operating temperature (Ambient temperature)	TOPR	-20	70	°C	(1), (2)

Note (1) 95 % RH Max. ( 40 °C ≥ Ta )

Maximum wet-bulb temperature at 39 °C or less. (Ta > 40 °C) No condensation.

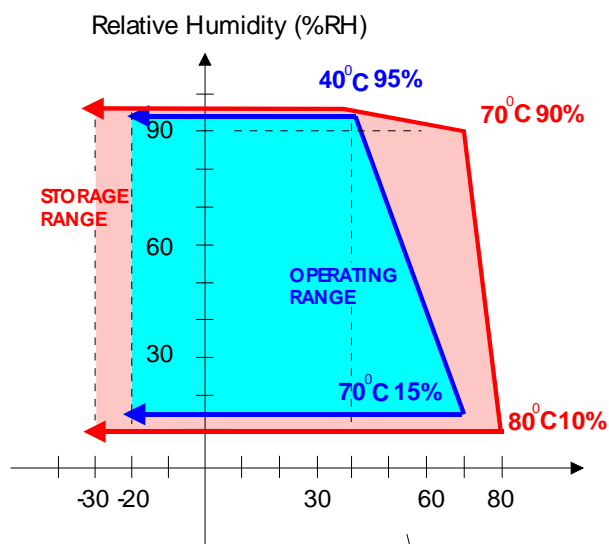

- (2) In case of below 0°, the response time of liquid crystal (LC) becomes slower and the color of panel becomes darker than normal one. Level of retardation depends on temperature, because of LC's character



*Microtips Technology Inc.*

Messrs.					
Product Specification	Model:	MTF-TQ35SP721-AV	Rev. No.	Issued Date.	Page.
			A	Aug. 09, 07	13 / 38

## 5.2 Electrical Absolute Rating

### 5.2.1 TFT-LCD Module

(Ta=25±2°C, V<sub>SS</sub>=GND=0)

Item	Symbol	Value		Unit	Condition
		Min.	Max.		
Power voltage	V <sub>DD</sub>	-0.3	+7.0	V	AV <sub>SS</sub> =0
	V <sub>CC</sub>	-0.3	+7.0	V	GND=0
	V <sub>GH</sub>	-0.3	+32.0	V	GND=0
	V <sub>GL</sub>	-22.0	+0.3	V	GND=0
	V <sub>GH</sub> -V <sub>GL</sub>	-0.3	+45	V	GND=0

### 5.2.2 Back-Light Unit

(Ta=25±2°C)

Item	Symbol	Min.	Max.	Unit	Note
Current	I <sub>f</sub>	--	40	mA	(1)

Note (1) Permanent damage to the device may occur if maximum values are exceeded or reverse voltage is loaded.

Functional operation should be restricted to the conditions described under normal operating conditions.



Messrs.					
Product Specification	Model:	MTF-TQ35SP721-AV	Rev. No.	Issued Date.	Page.
			A	Aug. 09, 07	14 / 38

## 6. ELECTRICAL CHARACTERISTICS

### 6.1 DC Electrical Characteristics

(Ta=25±2°C)

Item	Symbol	Value			Unit	Condition
		Min.	Typ.	Max.		
Digital Power Supply	V <sub>CC</sub>	3.0	3.3	3.6	V	--
Digital Operating Current	I <sub>CC</sub>	--	6.0	--	mA	--
Analog Power Supply	V <sub>DD</sub>	3.8	5.0	5.5	V	--
Analog Operating Current	I <sub>DD</sub>	--	5.0	--	mA	--
Gate On Power	V <sub>GH</sub>	--	15	--	V	--
Gate Off Power	V <sub>GL</sub>	--	-10	--	V	--
Gate On Current	I <sub>GH</sub>	--	50	--	μA	--
Gate Off Current	I <sub>GL</sub>	--	50	--	μA	--
Vcom	VcomAC	--	5	--	V	--
	VcomAD	--	1.1	--	V	--
Frame frequency	fFrame	--	60	90	Hz	--



Messrs.					
Product Specification	Model:	MTF-TQ35SP721-AV	Rev. No.	Issued Date.	Page.
			A	Aug. 09, 07	15 / 38

## 6.2 AC Characteristics

### 6.2.1 Input signal characteristics

#### 6.2.1.1 Digital Serial RGB interface (960x240 resolution)

PARAMETER		Symbol	Min.	Typ.	Max.	Unit
CLK period		TOSC	--	52	--	ns
Data setup time		TSU	12	--	--	ns
Data hold time		THD	12	--	--	ns
IHS period		TH	--	1224	--	TOSC
IHS pulse width		THS	5	90	--	TOSC
IHS rising time		TCr	12	--	--	ns
IHS falling time		TCf	12	--	--	ns
IVS pulse width		TVS	1	3	5	TH
IVS rising time		TVr	12	--	--	ns
IVS falling time		TVf	12	--	--	μs
IVS-DEN time	NTSC	TVSE	--	18	--	TH
	PAL	TVSE	--	26	--	TH
IHS-DEN time		THE	108	204	264	TOSC
DEN pulse width		TEP	--	960	--	TOSC
DEN-STH time		TDES	--	3	--	TOSC
IVS period	NTSC	--	--	262.5	--	TH
	PAL	--	--	312.5	--	TH

Note:

When SYNC mode is used, 1st data start from 204th CLK after IHS falling



*Microtips Technology Inc.*

Messrs.					
Product Specification	Model:	MTF-TQ35SP721-AV	Rev. No.	Issued Date.	Page.
			A	Aug. 09, 07	16 / 38

#### 6.2.1.2 Digital Parallel RGB interface (960x240 resolution)

PARAMETER		Symbol	Min.	Typ.	Max.	Unit
CLK period		TOSC	--	156	--	ns
Data setup time		TSU	12	--	--	ns
Data hold time		THD	12	--	--	ns
IHS period		TH	--	408	--	TOSC
IHS pulse width		THS	5	30	--	TOSC
IHS rising time		TCr	12	--	--	ns
IHS falling time		TCf	12	--	--	ns
IVS pulse width		TVS	1	3	5	TH
IVS rising time		TVr	12	--	--	ns
IVS falling time		TVf	12	--	--	µs
IVS-DEN time	NTSC	TVSE	--	18	--	TH
	PAL	TVSE	--	26	--	TH
IHS-DEN time		THE	36	68	88	TOSC
DEN pulse width		TEP	--	320	--	TOSC
DEN-STH time		TDES	--	1	--	TOSC
IVS period	NTSC	--	--	262.5	--	TH
	PAL	--	--	312.5	--	TH

Note:

When SYNC mode is used, 1st data start from 68th CLK after IHS falling.

#### 6.2.1.3 CCIR601/656 Interface

PARAMETER		Symbol	Min.	Typ.	Max.	Unit
CLK period		TOSC	--	37	--	ns
Data setup time		TSU	12	--	--	ns
Data hold time		THD	12	--	--	ns
IVS falling to IHS rising time for odd field		THVO	1	--	--	Tosc
IVS falling to HIS falling time for even field		THVE	1	--	--	Tosc



*Microtips Technology Inc.*



Messrs.					
Product Specification	Model:	MTF-TQ35SP721-AV	Rev. No.	Issued Date.	Page.
			A	Aug. 09, 07	17 / 38

#### 6.2.1.4 Hardware reset timing

PARAMETER	Symbol	Min.	Typ.	Max.	Unit
RESETB low pulse width	TRSB	10	--	--	ns
STB Setup Time	TSTB	20	--	--	ns

#### 6.2.2 Output signal characteristics for digital input signal

PARAMETER	Symbol	Min.	Typ.	Max.	Unit
Rising time	Tr	--	--	10	ns
Falling time	Tf	--	--	10	ns
Internal STH setup time	TSUS	12	--	--	ns
Internal STH hold time	THDS	12	--	--	ns
Internal data setup time	TSUD	60	--	--	ns
Internal data hold time	THDD	40	--	--	ns
OEH pulse width	TOEH	--	1248	--	ns
OEV pulse width	TOEV	--	4992	--	ns
CKV pulse width	TCKV	--	3744	--	ns
IHS-OEH time	T1	--	4368	--	ns
IHS-CKV time	T2	--	2496	--	ns
IHS-OEV time	T3	--	624	--	ns
STV setup time	TSUV	--	1872	--	ns
STV pulse width	TSTV	--	1	--	TH
IVS-STV time	NTSC	TVS1	--	19	TH
	PAL	TVS1	--	27	TH
OEH-STV time	TOES	--	2	--	TH
Output settling time	TST	--	12	20	μs



Product Specification	Model:	MTF-TQ35SP721-AV	Rev. No.	Issued Date.	Page.
			A	Aug. 09, 07	18 / 38

## 7. OPERATION SPECIFICATIONS

### 7.1 Timing Controller Timing Chart

#### 7.1.1 Clock and Data waveform

- **CCIR601 ( HS\_POL = "L" in Register R2 )**

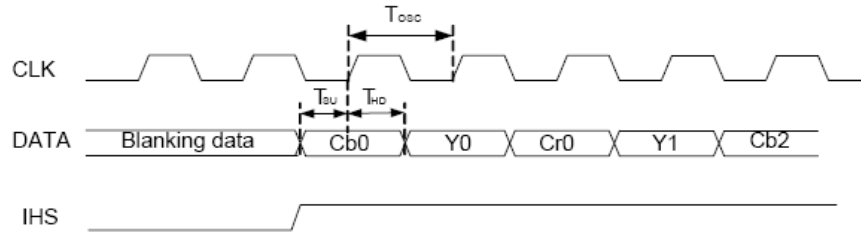

- **CCIR656**

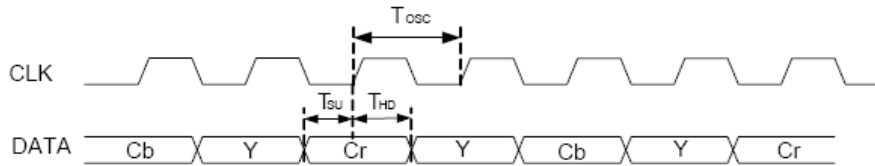

- **Digital Serial RGB**

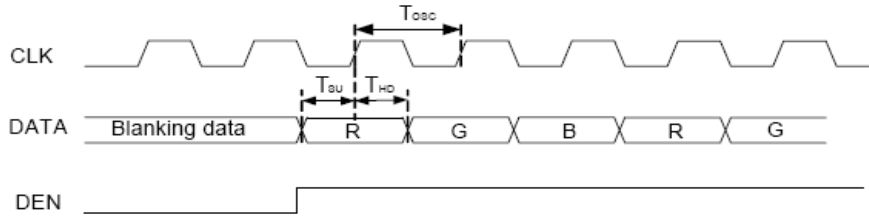

- **Digital Parallel RGB**

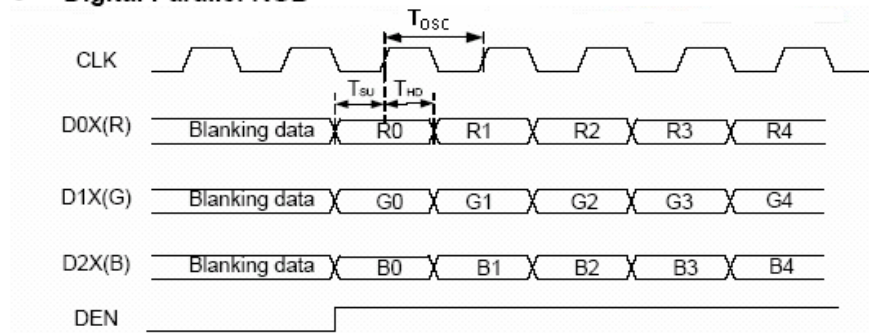

Messrs.					
Product Specification	Model:	MTF-TQ35SP721-AV	Rev. No.	Issued Date.	Page.
			A	Aug. 09, 07	19 / 38

### 7.1.2 Digital/Analog RGB timing waveform

#### 7.1.2.1 IHS and horizontal control timing waveform

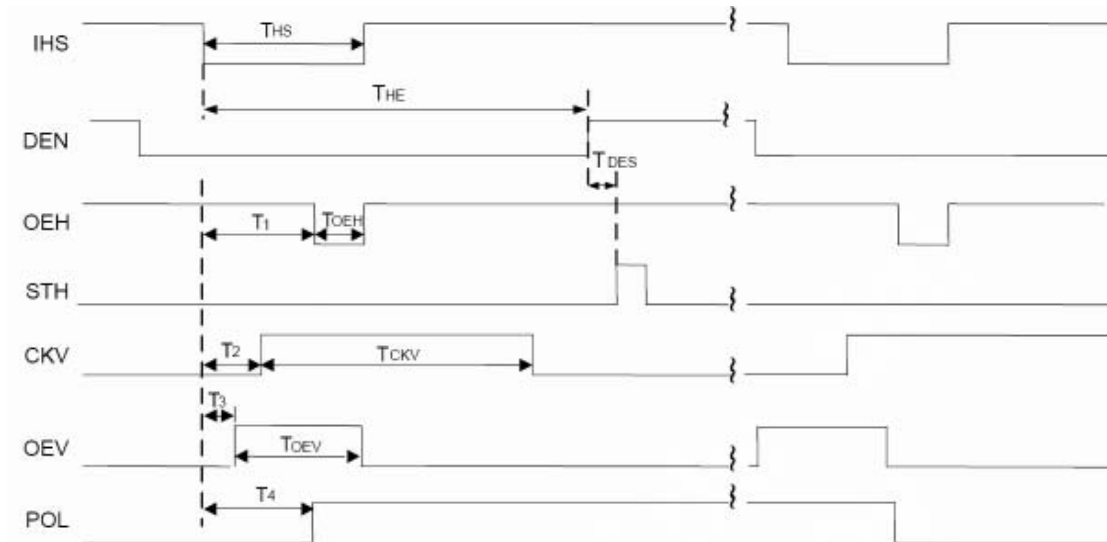

Messrs.					
Product Specification	Model:	MTF-TQ35SP721-AV	Rev. No.	Issued Date.	Page.
			A	Aug. 09, 07	20 / 38

7.1.2.2 IHS and vertical shift clock timing waveform

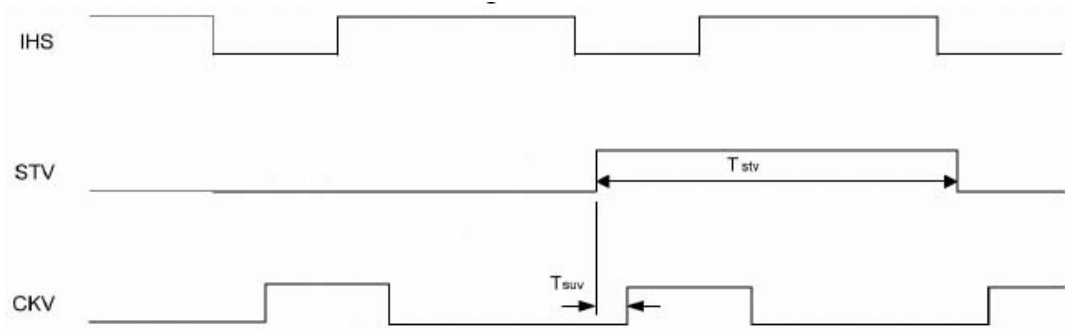

7.1.2.3 IHS and vertical control timing waveform

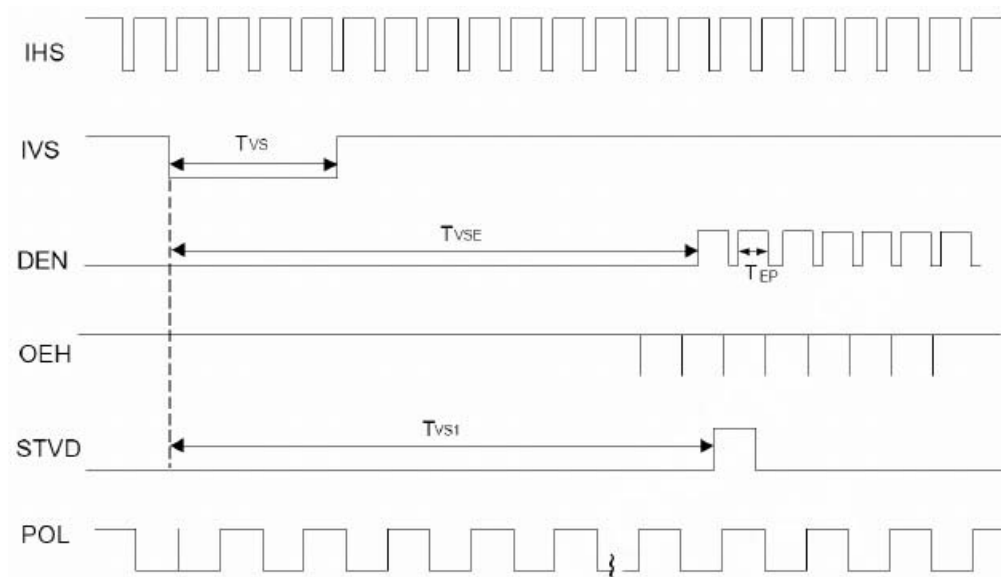

Messrs.					
Product Specification	Model:	MTF-TQ35SP721-AV	Rev. No.	Issued Date.	Page.
			A	Aug. 09, 07	21 / 38

7.1.3 CCIR601 timing waveform (VS\_POL= "H",HS\_POL="L" in Register R2)

7.1.3.1 IHS and IVS Timing

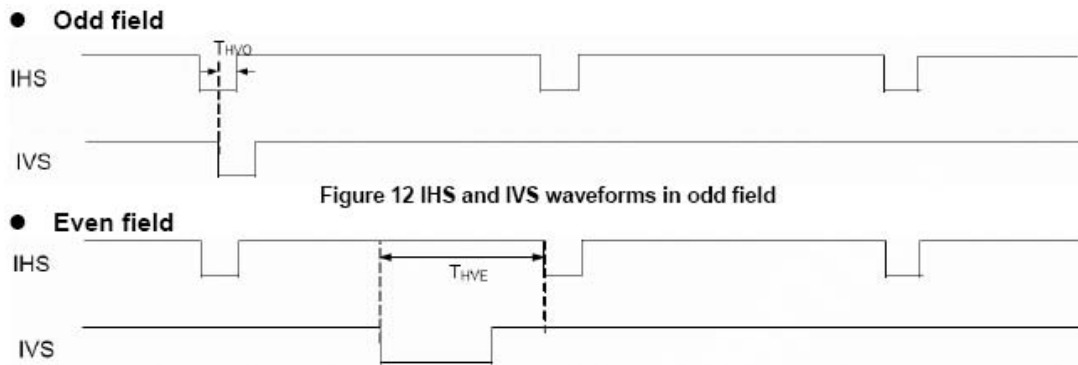

Messrs.

Product Specification	Model:	MTF-TQ35SP721-AV	Rev. No.	Issued Date.	Page.
			A	Aug. 09, 07	22 / 38

● ITU-R BT.601 NTSC Input Timing

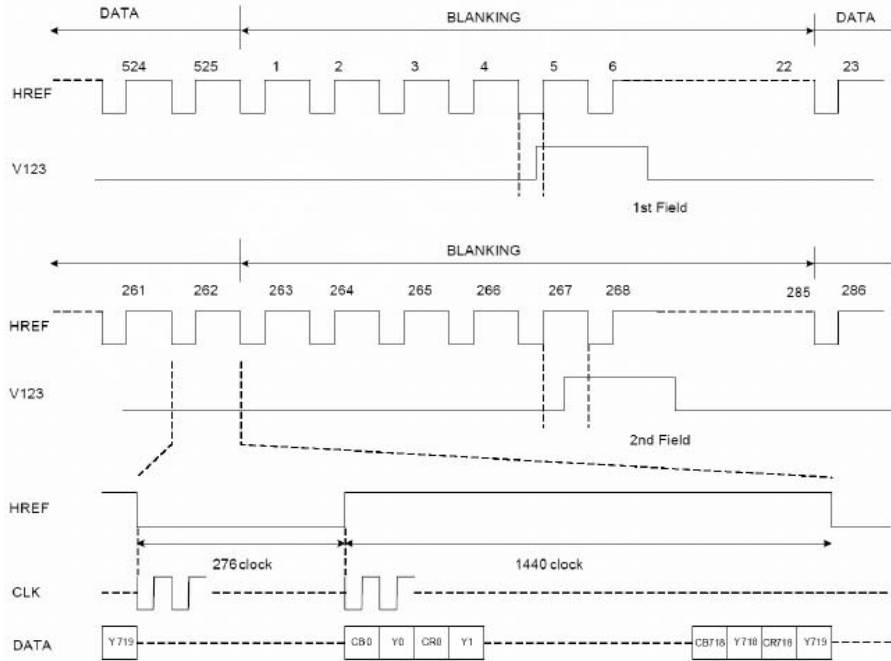

● ITU-R BT.601 PAL Input Timing

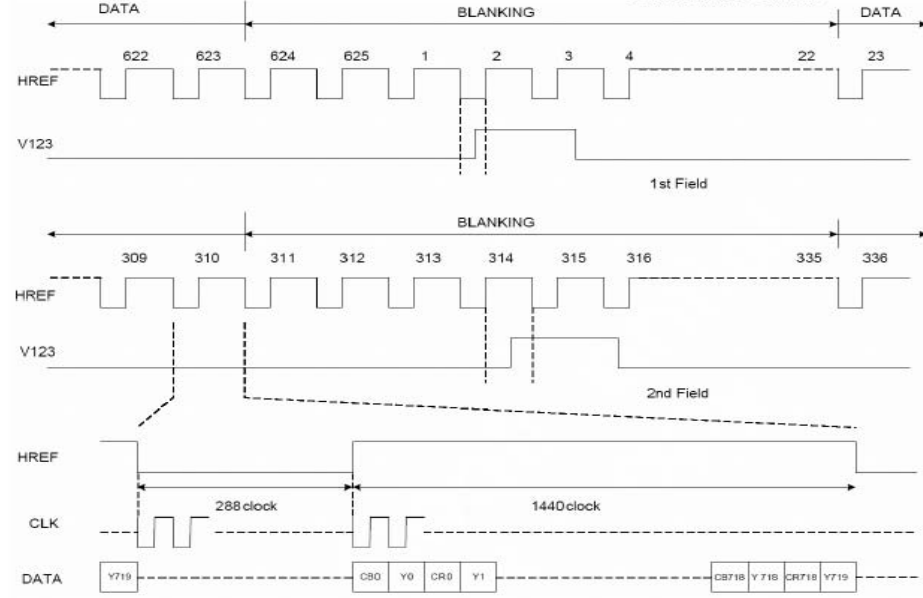

Microtips Technology Inc.

Messrs.					
Product Specification	Model:	MTF-TQ35SP721-AV	Rev. No.	Issued Date.	Page.
			A	Aug. 09, 07	23 / 38

## 7.2 SPI TIMING CHARACTERISTICS

PARAMETER	Symbol	Min.	Typ.	Max.	Unit
SPCK period	TCK	60	--	--	ns
SPCK high width	TCKH	30	--	--	ns
SPCK low width	TCKL	30	--	--	ns
Data setup time	TSU1	12	--	--	ns
Data hold time	THD1	12	--	--	ns
SPENA to SPCK setup time	TCS	20	--	--	ns
SPENA to SPDA hold time	TCE	20	--	--	ns
SPENA high pulse width	TCD	50	--	--	ns
SPDA output latency	TCR	--	1/2	--	TcK

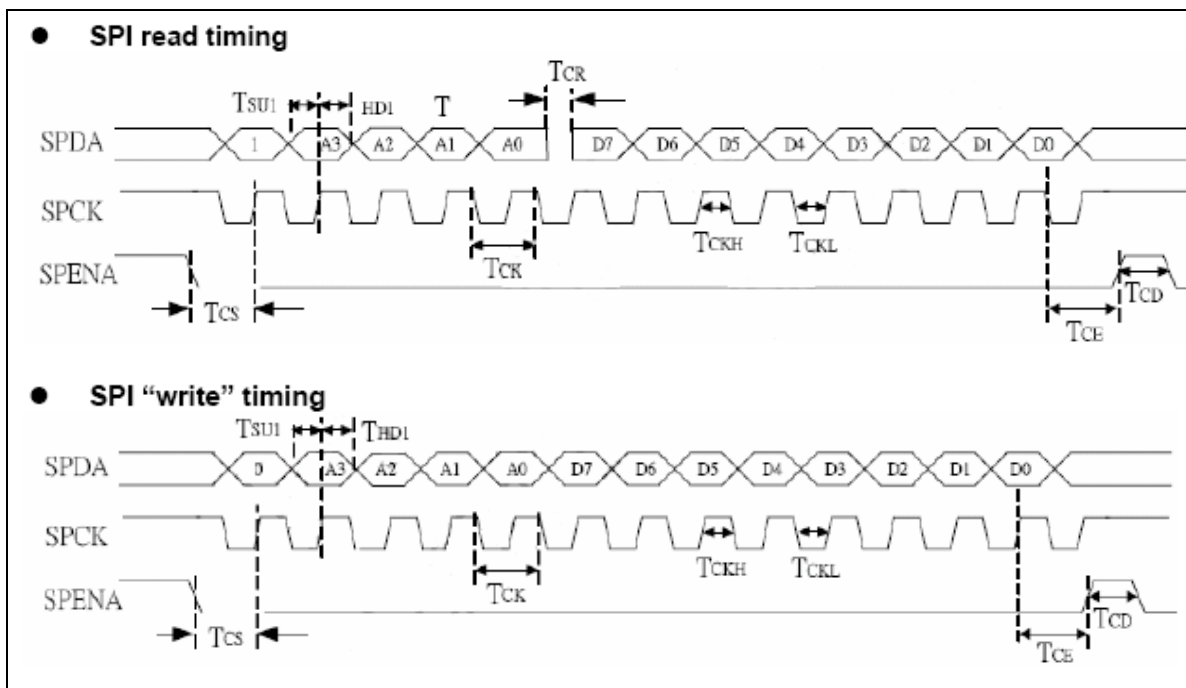

Messrs.					
Product Specification	Model:	MTF-TQ35SP721-AV	Rev. No.	Issued Date.	Page.
			A	Aug. 09, 07	24 / 38

## 8. COMMAND LIST & INSTRUCTION DESCRIPTIONS

### 8.1 Command List

Refer to the Appendix 1: HX-8615 & HX-8218 IC Specification

### 8.2 Instruction Descriptions

Refer to the Appendix 1: HX-8615 & HX-8218 IC Specification

### 8.3 Power ON/OFF sequence

To prevent the device from damage due to latch up, the power ON/OFF sequence shown below must be followed.

When power on: VDD→VGL→VGH

When power off: VGH→VGL→VDD

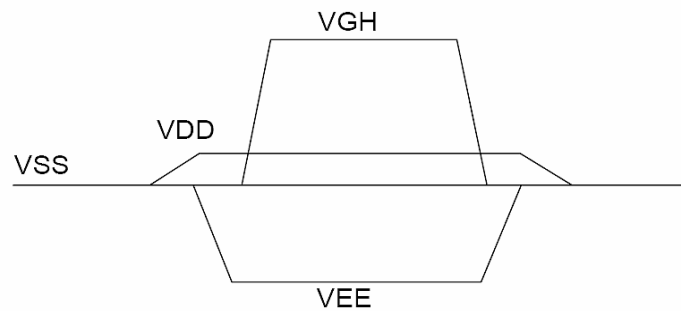



Messrs.					
Product Specification	Model:	MTF-TQ35SP721-AV	Rev. No.	Issued Date.	Page.
			A	Aug. 09, 07	25 / 38

## 9. BACKLIGHT SPECIFICATIONS

### 9.1 Absolute Maximum Ratings

Ta = 25°C

Parameter	Symbol	Maximun Rating	Units
Peak Forward Current	I <sub>FM</sub>	60	mA
Reverse Voltage	V <sub>R</sub>	20	V
LED Power Dissipation	P <sub>D</sub>	256	mW
Operating Temperature	T <sub>OPR</sub>	-20~+70	°C
Storage Temperature	T <sub>STG</sub>	-30~+80	°C

### 9.2 Electrical/Operating Characteristics

Ta = 25°C

Parameter	Symbol	Min.	Typ.	Max.	Units	Test Condition
Forward Voltage(VLED1\VLED2)	V <sub>F</sub>	9.0	10.2	11.4	V	Ta=25°C IP=40mA
LED (1+2) Current	I <sub>L</sub>	--	20+20	--	mA	
Uniformity*	--	75	--	--	%	
Chromaticity Coordinates	X	0.27	0.30	0.32	--	
	Y	0.27	0.31	0.33	--	

\*Uniformity = (Min./Max.) x 100%

### 9.3 Electrical Circuit of Backlight

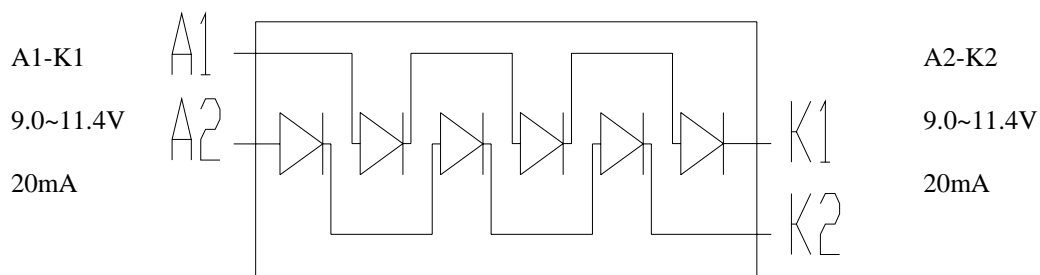

Microtips Technology Inc.

Messrs.					
Product Specification	Model:	MTF-TQ35SP721-AV	Rev. No.	Issued Date.	Page.
			A	Aug. 09, 07	26 / 38

### 10. BASIC DISPLAY COLOR AND GRAY SCALE

Color		Input Color Data																											
		Red								Green								Blue											
		MSB				LSB				MSB				LSB				MSB				LSB							
		R7	R6	R5	R4	R3	R2	R1	R0	G7	G6	G5	G4	G3	G2	G1	G0	B7	B6	B5	B4	B3	B2	B1	B0				
Basic Colors	Black	0	0	0	0	0	0	0	0	0	0	0	0	0	0	0	0	0	0	0	0	0	0	0	0	0	0	0	0
	Red(255)	1	1	1	1	1	1	1	1	0	0	0	0	0	0	0	0	0	0	0	0	0	0	0	0	0	0	0	0
	Green(255)	0	0	0	0	0	0	0	0	1	1	1	1	1	1	1	1	0	0	0	0	0	0	0	0	0	0	0	0
	Blue(255)	0	0	0	0	0	0	0	0	0	0	0	0	0	0	0	0	1	1	1	1	1	1	1	1	1	1	1	1
	Cyan	0	0	0	0	0	0	0	0	1	1	1	1	1	1	1	1	1	1	1	1	1	1	1	1	1	1	1	1
	Magenta	1	1	1	1	1	1	1	1	0	0	0	0	0	0	0	0	0	0	0	0	0	0	0	0	0	0	0	0
	Yellow	1	1	1	1	1	1	1	1	1	1	1	1	1	1	1	1	0	0	0	0	0	0	0	0	0	0	0	0
	White	1	1	1	1	1	1	1	1	1	1	1	1	1	1	1	1	1	1	1	1	1	1	1	1	1	1	1	1
Red	Red(0) Dark	0	0	0	0	0	0	0	0	0	0	0	0	0	0	0	0	0	0	0	0	0	0	0	0	0	0	0	0
	Red(1)	0	0	0	0	0	0	0	1	0	0	0	0	0	0	0	0	0	0	0	0	0	0	0	0	0	0	0	0
	Red(2)	0	0	0	0	0	0	1	0	0	0	0	0	0	0	0	0	0	0	0	0	0	0	0	0	0	0	0	0
	:	:	:	:	:	:	:	:	:	:	:	:	:	:	:	:	:	:	:	:	:	:	:	:	:	:	:	:	:
	Red(253)	1	1	1	1	1	1	0	1	0	0	0	0	0	0	0	0	0	0	0	0	0	0	0	0	0	0	0	0
	Red(254)	1	1	1	1	1	1	1	0	0	0	0	0	0	0	0	0	0	0	0	0	0	0	0	0	0	0	0	0
	Red(255) Bright	1	1	1	1	1	1	1	1	0	0	0	0	0	0	0	0	0	0	0	0	0	0	0	0	0	0	0	0
Green	Green(0) Dark	0	0	0	0	0	0	0	0	0	0	0	0	0	0	0	0	0	0	0	0	0	0	0	0	0	0	0	0
	Green(1)	0	0	0	0	0	0	0	0	0	0	0	0	0	0	0	1	0	0	0	0	0	0	0	0	0	0	0	0
	Green(2)	0	0	0	0	0	0	0	0	0	0	0	0	0	0	1	0	0	0	0	0	0	0	0	0	0	0	0	0
	:	:	:	:	:	:	:	:	:	:	:	:	:	:	:	:	:	:	:	:	:	:	:	:	:	:	:	:	:
	Green(253)	0	0	0	0	0	0	0	0	1	1	1	1	1	1	0	1	0	0	0	0	0	0	0	0	0	0	0	0
	Green(254)	0	0	0	0	0	0	0	0	1	1	1	1	1	1	1	0	0	0	0	0	0	0	0	0	0	0	0	0
	Green(255) Bright	0	0	0	0	0	0	0	0	1	1	1	1	1	1	1	1	0	0	0	0	0	0	0	0	0	0	0	0
Blue	Blue(0) Dark	0	0	0	0	0	0	0	0	0	0	0	0	0	0	0	0	0	0	0	0	0	0	0	0	0	0	0	0
	Blue(1)	0	0	0	0	0	0	0	0	0	0	0	0	0	0	0	0	0	0	0	0	0	0	0	0	0	0	1	0
	Blue(2)	0	0	0	0	0	0	0	0	0	0	0	0	0	0	0	0	0	0	0	0	0	0	0	0	0	0	1	0
	:	:	:	:	:	:	:	:	:	:	:	:	:	:	:	:	:	:	:	:	:	:	:	:	:	:	:	:	:
	Blue(253)	0	0	0	0	0	0	0	0	0	0	0	0	0	0	0	0	1	1	1	1	1	1	1	1	1	0	1	0
	Blue(254)	0	0	0	0	0	0	0	0	0	0	0	0	0	0	0	0	1	1	1	1	1	1	1	1	1	1	0	1
	Blue(255) Bright	0	0	0	0	0	0	0	0	0	0	0	0	0	0	0	0	1	1	1	1	1	1	1	1	1	1	1	1



Messrs.					
Product Specification	Model:	MTF-TQ35SP721-AV	Rev. No.	Issued Date.	Page.
			A	Aug. 09, 07	27 / 38

## 11. QUALITY STANDARD FOR LCD

### 11.1 Objective

This specification book is the standard for LCD module general inspection. And also this book will be refer t o customer approval specification.

### 11.2 Scope

This specification book is applicable to general LCD module. If supplier has any doubt or requirement, then it can be discussed.

#### 11.2.1 Acceptable Quality Level

INSPECTION	SAMPLING PROCEDURES	A.Q.L
Major	MIL-STD-105E Inspection Level II Normal Inspection Single sample inspection	1
Minor	MIL-STD-105E Inspection Level II Normal Inspection Single sample inspection	1.5

#### Major defect :

A major defect is a defect that could result in failure or extremely reduction on the usability of the product for its intended purpose.

#### Minor defect :

A minor defect is one that does not materially reduce the usability of the product for its intended purple or is a departure from established standards giving no significant bearing on the effective use or operation of the unit.

#### 11.2.2 Inspection Conditions

##### 11.2.2.1 The environmental conditions for inspection shall be as follows

- Room Temperature :  $25 \pm 10^{\circ}\text{C}$
- Humidity Temperature :  $45 \pm 20\% \text{RH}$

##### 11.2.3 The external visual inspection

- The inspection shall be performed by using 40Watts fluorescent lamp for illumination and the distance between LCD and eyes of the inspector shall be 30cm or more.



Messrs.					
Product Specification	Model:	MTF-TQ35SP721-AV	Rev. No.	Issued Date.	Page.
			A	Aug. 09, 07	28 / 38

#### 11.2.4 Inspection Item

Pinhole, Bright spot, Black spot, White spot, Black line, White Line, Foreign particle, Bubble	The color of a small area is different from the remainder. The phenomenon dose not change with voltage.
Contrast variation	The color of a small area is different from the remainder. The phenomenon change with voltage.
Glass defect	Glass crack, Chip
Operating	Function, Contrast, Uniformity, Components

#### 11.2.5 Definition of the Area

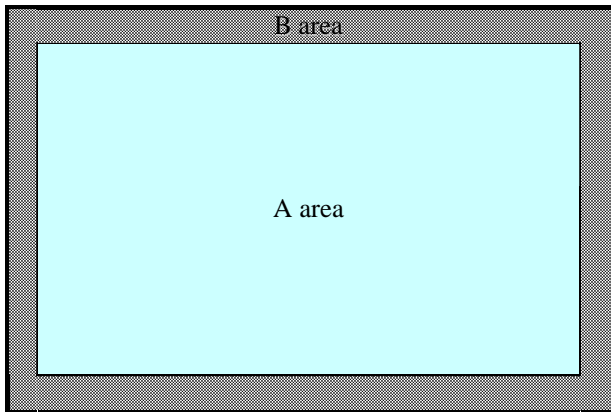

A area: Viewing Area  
 B area: Out of Viewing Area



Messrs.					
Product Specification	Model:	MTF-TQ35SP721-AV	Rev. No.	Issued Date.	Page.
			A	Aug. 09, 07	29 / 38

### 11.3 Inspection specification

#### 11.3.1 Non-operating inspection specification

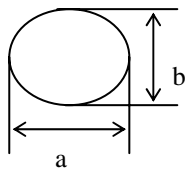
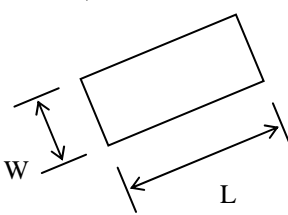
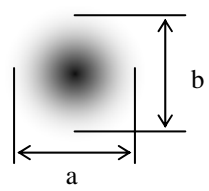
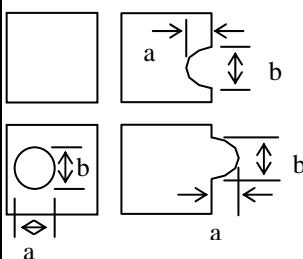
Class of defects	No.	Inspection Item	Criteria of defects		Acceptable Q'ty		
					Zone A	Zone B	
Major	1	Circuits	1. Circuit short		0	0	
			2. Circuit open				
Minor	2	Black spot, White spot, Bright spot, Foreign particle  $\phi = (a+b)/2$	A	$\phi \leq 0.1$	*	Ignore	
			B	$0.1 < \phi < 0.2$	3		
			C	$0.2 \leq \phi < 0.3$	1		
			D	$0.3 \leq \phi$	0		
			Total defect point (B,C)		3		
			* Reject when 5 or more spots are gathered within 5mm circle.				
	3	Black line, White line 	A	$W \leq 0.02$	-	*	Ignore
			B	$0.02 < W \leq 0.05$	$L \leq 5$	2	
			C	$0.05 < W \leq 0.1$	$L \leq 3$	2	
			D	$0.1 < W$	-	0	
Total defect point (B,C)			3				
* Reject when 5 or more spots are gathered within 5mm circle.							
4	Contrast variation  $\phi = (a+b)/2$	A	$\phi \leq 0.3$	Ignore	Ignore		
		B	$0.3 < \phi \leq 0.4$	2			
		C	$0.4 < \phi \leq 0.5$	1			
		D	$0.5 < \phi$	0			
		Total defect point (B,C)		3			
5	Pattern deformity  $\phi = (a+b)/2$	1. Pin hole					
		A	$\phi \leq 0.15$	Ignore	Ignore		
		B	$0.15 < \phi \leq 0.2$	2 (*)			
			$0.2 < \phi$	0			
		* Two pin hole shall not formed in the single dot					
		2. Excess, void					
A	$a \leq 0.2$ and $b \leq 0.2$	Ignore	Ignore				
B	$0.2 < a$ or $0.2 < b$	0					



Messrs.					
Product Specification	Model:	MTF-TQ35SP721-AV	Rev. No.	Issued Date.	Page.
			A	Aug. 09, 07	30 / 38

Minor	6	Dot defect	A	Bright dot	$N \leq 2$	Ignore
			B	Dark dot	$N \leq 3$	
			C	Total defect dot	$N \leq 4$	
			* This inspection item does not apply to B/W LCD			
	7	Bubble between Polarizer and panel	A	$\phi \leq 0.3$	Ignore	Ignore
			B	$0.3 < \phi \leq 0.5$	2	
			C	$0.5 < \phi$	0	
	8	Polarizer scratch and particle	Circular : Same as inspection item No.2			Ignore
			Linear : Same as inspection item No.3			
	9	Polarizer Dent	A	$\phi \leq 0.2$	Ignore	Ignore
			B	$0.2 < \phi \leq 0.3$	2	
			C	$0.3 < \phi \leq 0.4$	1	
			D	$0.4 < \phi$	0	
			Total defect point (B,C)		3	
	10	Bubble in the Cell	Any size		0	0
11	Dirt on polarizer	Dirt which can be wiped easily should be accepted.				
12	Protection film	The protection film should not be stripped up to viewing area and the peeled off angle should not exceed 20 degrees.				
13	Polarizer shift	<ol style="list-style-type: none"> <li>Shifting in position should not exceed the glass outline dimension.</li> <li>Incomplete covering of the viewing area due to shifting is not allowed.</li> <li>Shifting in position should be within the tolerance (refer to module dimensional drawing)</li> </ol>				
14	Silicon	<ol style="list-style-type: none"> <li>Silicon must cover all circuits.</li> <li>Silicon thickness should be within specification (refer to module dimensional drawing)</li> </ol>				
15	Tape	<ol style="list-style-type: none"> <li>Location: refer to specification.</li> <li>Insufficient adhesive.</li> </ol>				
Major	16	TCP, FPC defect	Film or Pattern should not have crack.			
	17	Components	Missing components not allowed.			

\* Condition of item 2~9

- Distance between defects must be more than 10mm with light on, more than 15mm with light off.
- Total acceptable defect number
  - Defects with light on : 6 points



**Microtips Technology Inc.**

Messrs.					
Product Specification	Model:	MTF-TQ35SP721-AV	Rev. No.	Issued Date.	Page.
			A	Aug. 09, 07	31 / 38

Class of defects	No.	Inspection Item	Criteria of defects
Major	1	No display	--
	2	Abnormal operation	--
	3	Contrast defect	Judge according to module specification. Establish boundary sample if required.
	4	Viewing angle defect	Judge according to module specification. Establish boundary sample if required.
	5	Excess power consumption	Judge according to module specification.
	6	Back-light, LED defect	1. No lit-on 2. Different color 3. Low brightness
	7	Speaker, Vibrator defect	1. No operation 2. Abnormal operation
Minor	8	Cross-talk defect	No noticeable crosstalk. Establish boundary sample if required.
	9	Uneven brightness	No noticeable unevenness allowed. Establish boundary sample if required.
	10	Uneven color	No noticeable unevenness allowed. Establish boundary sample if required.
	11	Spot, Pinhole, Foreign particle, Line	Same as in Chapter 7.1



Messrs.					
Product Specification	Model:	MTF-TQ35SP721-AV	Rev. No.	Issued Date.	Page.
			A	Aug. 09, 07	32 / 38

## 12. RELIABILITY CONDITION FOR LCD

### 12.1 LCM Reliability Test

#### 12.1.1 Reliability Test Condition

No.	TFT	Item	Condition	Test time	Note
1	V	High temp. operating	70°C	240 Hrs	--
2	V	Low temp. operating	-20°C	240 Hrs	--
3	V	High temp. storage	80°C	240 Hrs	--
4	V	Low temp. storage	-30°C	240 Hrs	--
5	V	High Temp / High Humidity Storage	T = 60°C /90%. For (But no condensation dew)	24 Hrs	--
6	V	High Temp/ High Humidity Operating	T = 40°C /90% For (But no condensation dew)	240 Hrs	--
7	V	Thermal Shock	-30°C → +25°C → +80°C, 50 cycle 30min 5min 30min	--	--

#### 12.1.2 Operating Test Pattern

No.	Items	Test Pattern
1	Test Pattern in Driving Condition	1. Full Red 2. Full Green 3. Full Blue 4. Gradation (horizontal) 5. Gradation (vertical) 6. Character (111111) 7. Full White 8. Full Black 9. Black Line (horizontal) 10. Black Line (vertical) 11. Mosaic (1X1) The Test Pattern is changed 1sec. The same Pattern are repeated.
2	Black Square	Black Window and White Background





Messrs.					
Product Specification	Model:	MTF-TQ35SP721-AV	Rev. No.	Issued Date.	Page.
			A	Aug. 09, 07	33 / 38

### 12.1.3 Test Method

The method of visual inspection is equal to the appearance standard. Evaluation and assessment made two hours after return to room temperature ( $25 \pm 5^{\circ}\text{C}$ ). The LCDs subjected to the test must not have dew condensation.

The test pattern is gray scale and the operating voltage sweep from  $V_{th}$  to  $V_{sat}$  variable.

The non-uniformity and other appearance are checked in LCD.

### 12.1.4 Result Evaluation Criteria

There should be no change which might affect the practical display function when the display quality test is conducted under normal operating condition.

### 12.1.5 Life time

Life time expectancy of LCD Panel is approximately 50,000 hours under the room environment. Definition on the termination of life time is deterioration of contrast ratio by one fifth against initial value.

### 12.1.6 Basic rule for Reliability test

- \* Place all the samples under room temperature & humidity for 24 hours after reliability stressing.
- \* Room environment means  $25 \pm 10^{\circ}\text{C}$ ,  $45 \pm 20\% \text{RH}$
- \* There should be no condensation during the test.
- \* One LCD module shall be used for one test item only and once.

### 12.1.7 Judgment Criteria for reliability test No. 1-2

- \* Contrast (or Brightness) ratio variation is within 50% of the initial value.
- \* No abnormal function
- \* No extreme decay on appearance

### 12.1.8 Life time

Display (LCD module) : Life time expectancy of LCD Panel is approximately 50,000 hours under the room environment.

## 12.2 Touch panel Reliability

No.	Items	Min.	Typ.	Max.	Unit	Remark
1	Activation Force	50	100	150	g	1. within active area. 2. R0.8mm polyacetal pen or finger.
2	Surface Hardness	3	-	-	H	Judgment ref. JIS-K5600
3	Durability (Writing Life)	100,000	-	-	characters	1. within active area. 2. R0.8mm polyacetal pen. 3. Load: 150g 4. Speed: 60mm/sec
4	Durability (Pitting Life)	1,000,000	-	-	touches	1. within active area. 2. R0.8mm polyacetal pen. 3. Load: 250g 4. Frequency: 260 times/min



Messrs.					
Product Specification	Model:	MTF-TQ35SP721-AV	Rev. No.	Issued Date.	Page.
			A	Aug. 09, 07	34 / 38

### 13. PRECAUTIONS





#### 13.1 Operation

Burn-in sometimes happens when the same character was displayed at along time. Therefore, to prevent Burn-in, it is recommended to set up a Screen-saver function.

#### 13.2 Safety

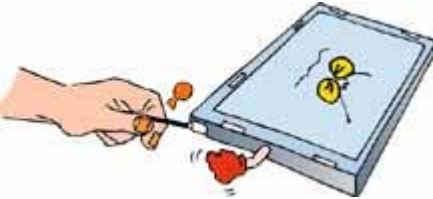
The liquid crystal in the LCD is poisonous, DO NOT put it in your mouth. If the liquid crystal touch es your skin or clothes, wash it off immediately using soap and water.







#### 13.3 Handling

	<p>a. The LCD module shall be installed flat, without twisting or bending.</p> <p>b. COF or FPC has narrow pattern width, so easily become open circuit by external force. DO NOT apply pressure to COF or FPC especially in bending area.</p>
	<p>c. To avoid damage in appearance or malfunction, DO NOT subject the module to mechanical shock or to excessive force on its surface.</p>
	<p>d. The polarizer attached to the display is very easy to damage, handle it with care to avoid scratching.</p>
	<p>e. To avoid contamination on the display surface, DO NOT touch the display surface with bare hands.</p> <p>f. Provide a space so that the LCD module does not come into contact with other components.</p>

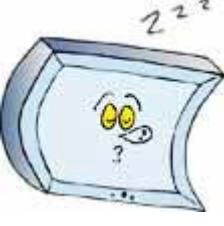

Messrs.

Product Specification	Model:	MTF-TQ35SP721-AV	Rev. No.	Issued Date.	Page.
			A	Aug. 09, 07	35 / 38

	<p>g. To protect the LCD panel from external pressure, put covering glass (acrylic board or similar board) to keep appropriate space between them.</p>
	<p>h. Be careful for condensation at sudden temperature change. Condensation makes damage to polarizer or electrical contacted parts. And after fading condensation, smear or spot will occur.</p>
	<p>i. Property of semiconductor devices may be affected when they are exposed to light possibly resulting in malfunctioning of the ICs. To prevent such malfunctioning of the ICs, your design and mounting layout done are so that the IC is not exposed to light in actual use.</p>
	<p>j. Strong light exposure causes degradation of color filter. It may not recover</p>
	<p>k. DO NOT contact with water to avoid Metal corrosion.</p> <p>l. When it is not in use, the screen must be turned off or the pattern must be frequently changed by a screen saver. If it displays the same pattern for a long period of time, brightness down/image sticking may develop due to the LCD structure.</p>
	<p>m. Never disassemble LCD product under any circumstances. If unqualified operators or users assemble the product after disassembling it, it may not function or its operation may be seriously affected.</p>



Messrs.					
Product Specification	Model:	MTF-TQ35SP721-AV	Rev. No.	Issued Date.	Page.
			A	Aug. 09, 07	36 / 38

#### 13.4 Static electricity

Since a module is composed of electronic circuits, it is not strong to electrostatic discharge.

	<ol style="list-style-type: none"> <li>The LCD module shall be installed flat, without twisting or bending. Ground soldering iron tips, tools and testers when they operate.</li> <li>Ground your body when handling the products.</li> <li>DO NOT apply voltage to the input terminal without applying power supply.</li> <li>DO NOT apply voltage that exceeds the absolute maximum rating.</li> <li>Store the products in an anti-electrostatic container.</li> <li>Peel off protect tape, attached to polarizer, slowly to minimize ESD damage.</li> </ol>
---	--

#### 13.5 Storage

	<p>Store the products in a dark place at +5 ~ +25 degree C, low humidity (50%RH or less). DO NOT store the products in an atmosphere containing organic solvents or corrosive gases.</p>
---	--

#### 13.6 Cleaning

	<ol style="list-style-type: none"> <li>DO NOT wipe the polarizer with dry cloth, as it might cause scratch.</li> <li>Wipe the polarizer with a soft cloth soaked with petroleum IPA, other chemical might damage.</li> </ol>
---	--

#### 13.7 Waste

	<p>When dispose of LCD module, manage it at the production waste according to the relevant laws and regulations.</p>
---	--



Messrs.					
Product Specification	Model:	MTF-TQ35SP721-AV	Rev. No.	Issued Date.	Page.
			A	Aug. 09, 07	37 / 38

#### 14. WARRANTY

This product has been manufactured to your company's specifications as a part for use in your company's general electronic products. It is guaranteed to perform according to delivery specifications. For any other use apart from general electronic equipment, we cannot take responsibility if the product is used in medical devices, nuclear power control equipment, aerospace equipment, fire and security systems, or any other applications in which there is a direct risk to human life and where extremely high levels of reliability are required. If the product is to be used in any of the above applications, we will need to enter into a separate product liability agreement.

- 1 We cannot accept responsibility for any defect, which may arise from additional manufacturing of the product (including disassembly and reassembly), after product delivery.
- 2 We cannot accept responsibility for any defect, which may arise after the application of strong external force to the product.
- 3 We cannot accept responsibility for any defect, which may arise due to the application of static electricity after the product has passed your company's acceptance inspection procedures.
- 4 We cannot accept responsibility for industrial property, which may arise through the use of your product, with exception to those issues relating directly to the structure or method of manufacturing of our product. Microtips-origin longer than one year from Microtips production.

#### 15. DIMENSIONAL OUTLINES

See Next page.



*Microtips Technology Inc.*

