

# Am2602/9602

## Dual Retriggerable Resettable Monostable Multivibrator

### Distinctive Characteristics:

- Retriggerable 0 to 100% duty cycle.
- 50ns to  $\infty$  output pulse width range.
- Am2602 guaranteed pulse width change over temperature range.
- 100% reliability assurance testing including high temperature bake, temperature cycling, centrifuge and

package hermeticity testing in compliance with MIL-STD-883.

- Mixing privileges for obtaining price discounts. Refer to price list.
- Electrically tested and optically inspected dice for the assemblers of hybrid products.

### FUNCTIONAL DESCRIPTION

The Am2602 and Am9602 are dual DC-level sensitive resettable retriggerable monostable multivibrators which provide an output pulse whose duration and accuracy depend on external timing components.

Provision is made for triggering on the rising or falling edge of an input signal. All inputs are DC coupled making triggering independent of input rise and fall times. Each time the output from the OR trigger gate goes from a FALSE (LOW) to TRUE (HIGH) condition triggering occurs independent of the state of the monostable.

The direct clear facility allows a timing cycle to be terminated at any time during the cycle. A LOW signal on the  $\bar{C}_0$  input resets the monostable independent of other conditions.

The Am2602 is a selected Am9602 with a guaranteed pulse width change of less than 1% over the temperature range of 0°C to +75°C.

### LOGIC DIAGRAM

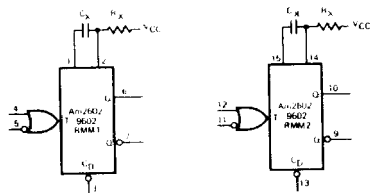

V<sub>CC</sub> = Pin 16

Gnd = Pin 8

### INTERNAL TIMING CIRCUITRY

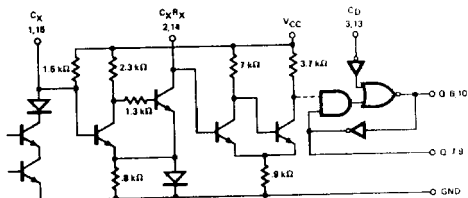

### ORDERING INFORMATION

Part Number	Package Type	Temperature Range	Order Number
Am2602	Molded DIP	0°C to +75°C	AM260259A
Am2602	Hermetic DIP	0°C to +75°C	AM260259E
Am2602	Hermetic DIP	-55°C to +125°C	AM260251E
Am2602	Hermetic Flat Pak	0°C to +125°C	AM260251N
Am2602	Dice	Note	AM2602XXD
Am9602	Molded DIP	0°C to +75°C	U6M960259X
Am9602	Hermetic DIP	0°C to +75°C	U7B960259X
Am9602	Hermetic DIP	-55°C to +125°C	U7B960251X
Am9602	Hermetic Flat Pak	-55°C to +125°C	U4L960251X
Am9602	Dice	Note	UXX9602XXD

Note: The dice supplied will contain units which meet both 0°C to +75°C and -55°C to +125°C temperature ranges.

### CONNECTION DIAGRAM Top View

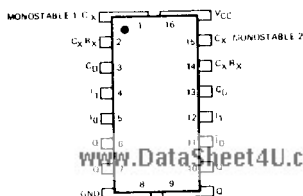

www.DataSheet4U.com

**MAXIMUM RATINGS** (Above which the useful life may be impaired)

Storage Temperature	-65°C to +150
Temperature (Ambient) Under Bias	-55°C to +125°C
Supply Voltage to Ground Potential (Pin 16 to Pin 8) Continuous	-0.5 V to +8
DC Voltage Applied to Outputs for High Output State	-0.5 V to +V <sub>CC</sub> mA
DC Input Voltage	-0.5 V to +5.5
Output Current Into Outputs When Output is LOW	50 mA
DC Input Current	-30 mA to +5 mA

**ELECTRICAL CHARACTERISTICS**

Am260250/960250X T<sub>A</sub> = 0°C to +75°C V<sub>CC</sub> = 4.75 to 5.25 V (COM grade)  
 Am260251/960251X T<sub>A</sub> = -55°C to +125°C V<sub>CC</sub> = 4.50 to 5.50 V (MIL grade)

**DC Characteristics** Over Operating Range (Note 1)

Parameters	Operating Range	Test Conditions	LIMITS						Units		
			T <sub>A</sub> = MIN		T <sub>A</sub> = +25°C		T <sub>A</sub> = MAX				
			Min	Max	Min	Typ	Max	Min	Max		
V <sub>OH</sub> Output HIGH Voltage	MIL or COM	V <sub>CC</sub> = MIN., I <sub>OH</sub> = -0.96 mA	2.40		2.40	3.6		2.40		Volt	
V <sub>OL</sub> Output LOW Voltage	MIL	I <sub>OL</sub> = 8 x I <sub>IL</sub> MAX.		0.40		0.2	0.40		0.40	Volt	
	COM	I <sub>OL</sub> = 8 x I <sub>IL</sub> MAX.		0.45		0.2	0.45		0.45		
V <sub>IH</sub> Input HIGH Voltage	MIL		2.00		1.70			1.50		Volt	
	COM		1.90		1.80			1.60			
V <sub>IL</sub> Input LOW Voltage	MIL		0.85				0.90		0.85	Volt	
	COM		0.85				0.85		0.85		
I <sub>IL</sub> Input Load Current	MIL	V <sub>IN</sub> = 0.40 V	V <sub>CC</sub> = MAX.	-1.60		-1.10	-1.60		-1.60	mA	
			V <sub>CC</sub> = MIN.	-1.24		-0.97	-1.24		-1.24		
	COM	V <sub>IN</sub> = 0.45 V	V <sub>CC</sub> = MAX.	-1.60		-1.00	-1.60		-1.60		
			V <sub>CC</sub> = MIN.	-1.41		-0.90	-1.41		-1.41		
I <sub>IH</sub> Reverse Input Current	MIL or COM	V <sub>CC</sub> = MAX., V <sub>IN</sub> = 4.5 V		60		2	60		60	μA	
I <sub>SC</sub> Short Circuit Current	MIL	V <sub>CC</sub> = 5.0 V, V <sub>O</sub> = 1.0 V			-8		-25			mA	
	COM	V <sub>CC</sub> = 5.0 V, V <sub>O</sub> = 1.0 V			-8		-35				
I <sub>DD</sub> Power Supply Current	9602 MIL	V <sub>CC</sub> = 5.0 V	GND Pins 5 and 11 R <sub>X</sub> = 10 kΩ		45		35	45		45	mA
					52		35	50		52	
	2602 COM	V <sub>CC</sub> = MAX.	GND Pins 5 and 11 R <sub>X</sub> = 10 kΩ		56		35	56		56	

**Switching Characteristics** (T<sub>A</sub> = 25°C)

Parameters	Test Conditions	2602 9602 MIL			9602 COM			Units	
		Min	Typ	Max	Min	Typ	Max		
t <sub>pd+</sub>	Turn Off Delay Negative Trigger Input to True Output		25	35	25	40		ns	
t <sub>pd-</sub>	Turn On Delay Negative Trigger Input to False Output	V <sub>CC</sub> = 5.0 V, C <sub>L</sub> = 15 pF	25	35	25	40		ns	
t <sub>pw</sub> (min)	Minimum Output Pulse Width	True Output (Q)	45	65	50	70		ns	
		False Output (Q̄)	55	75	60	80			
t <sub>pw</sub>	Pulse Width	V <sub>CC</sub> = 5.0 V, C <sub>L</sub> = 15 pF R <sub>X</sub> = 10 kΩ, C <sub>X</sub> = 1000 pF	3.08	3.42	3.76	3.08	3.42	3.76	μs
R <sub>X</sub>	Timing Resistor over Temperature Range (Note 2)		5	50	5	50		kΩ	
t <sub>pd-</sub> (C <sub>D</sub> )	Delay from C <sub>D</sub> to Q output LOW		11	17	11	17		ns	
<b>Am2602</b>			<b>Min</b>	<b>Typ</b>	<b>Max</b>				
Δt <sub>pw</sub> (T)	Maximum change in Pulse Width True Output over temperature range 0°C to +75°C	V <sub>CC</sub> = 5.0 V, C <sub>L</sub> = 15 pF R <sub>X</sub> = 10 kΩ, C <sub>X</sub> = 1000 pF						%	
	Maximum change in Pulse Width True Output over temperature range -55°C to +125°C (Am2602 MIL)				4.0	7.0			

Notes: 1. Tests are conducted with a 10 kΩ resistor placed between Pin 2 (14) and V<sub>CC</sub> unless otherwise noted.

2. Maximum permissible R<sub>X</sub> when used below 0°C is 25 kΩ.

## OPERATION RULES

1. An external resistor  $R_x$  and an external capacitor  $C_x$  are required as shown in the logic diagram. The values of  $R_x$  may vary from 5.0 k $\Omega$  to 50 k $\Omega$  for 0°C to +75°C operation and 5.0 k $\Omega$  to 25 k $\Omega$  for -55°C to +125°C operation.  $C_x$  may vary from 0 to any value necessary and obtainable.
2. If a fixed value of  $R_x$  is used, the following values are recommended:  $R_x = 30$  k $\Omega$  for 0°C to +75°C operation;  $R_x = 10$  k $\Omega$  for -55°C to +125°C operation.

3. The output pulse width  $T$  is defined as follows:

$$T = 0.32 R_x C_x \left[ 1 + \frac{0.7}{R_x} \right] \quad \text{(For } C_x \text{ greater than } 10^3 \text{ pF)} \quad \text{Where: } R_x \text{ is in k}\Omega, C_x \text{ is in pF, } T \text{ is in ns. For } C_x < 10^3 \text{ pF see Fig. 2}$$

4. If electrolytic type capacitors are to be used, it is recommended that they have low leakage. For capacitors with a high reverse leakage the following circuits can be used:



$$R < 0.6 R_x \text{ (Max)}$$

D<sub>1</sub>: any silicon type diode, such as FD700



This circuit also allows larger value of  $R$  to be used for longer output pulse width.

$$R < R_1 (0.7) (h_{FE} Q)$$

$$R_1 (\text{min}) < R_2 < R_1 (\text{max})$$

Q<sub>1</sub>: Any NPN silicon device with sufficient  $h_{FE}$  at low currents, such as 2N2511

Both circuits prevent reverse voltage across  $C_x$ . The pulse width  $T$  for the circuits is defined as follows:

$$T \approx 0.30 RC_x \left[ 1 + \frac{0.7}{R} \right] \quad \text{Where: } R \text{ is in k}\Omega, C_x \text{ is in pF, } T \text{ is in ns.}$$

5. To obtain variable pulse width, by remote trimming, the following circuit is recommended.

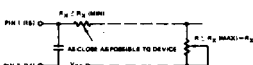

6. Under any operating condition,  $C_x$  and  $R_x$  (min) must be kept as close to the circuit as possible to minimize stray capacitance and reduce noise pickup.
7. Input Trigger Pulse Rules.

Input to Pin 5 (11)  
Pin 4 (12) = LOW  
Pin 3 (13) = HIGH

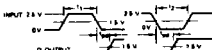

Input to Pin 4 (12)  
Pin 5 (11) = HIGH  
Pin 3 (13) = HIGH

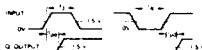

8. The retriggerable pulse width is calculated as shown below:

$$t_w = t_{pw} + t_{del} = 0.32 R_x C_x \left( 1 + \frac{0.7}{R_x} \right) + t_{del}$$

The retrigger pulse width is equal to the pulse width  $t_{pw}$  plus a delay time. For pulse widths greater than 500 ns,  $t_w$  can be approximated as  $t_{pw}$ .

NOTE: Retriggling will not occur if the retrigger pulse comes within  $0.32 R_x C_x \left( 1 + \frac{0.7}{R_x} \right)$  ns after the initial trigger pulse.

9. Reset Operation — The Am2602/9602 have an active LOW reset facility. By applying a low to the reset input, any timing cycle can be terminate if or any new cycle inhibited until the low reset input is removed. Trigger inputs will not produce spikes in the output when the reset is held low.

## DEFINITION OF TERMS

### SUBSCRIPT TERMS:

- H HIGH, applying to a HIGH logic level or when used with  $V_{CC}$  to indicate high  $V_{CC}$  value.
- I Input.
- L LOW, applying to LOW logic level or when used with  $V_{CC}$  to indicate low  $V_{CC}$  value.
- O Output.

### OPERATIONAL TERMS:

- $I_{IL}$  Forward input load current.
- $I_{OH}$  Output HIGH current, forced out of output in  $V_{OH}$  test.
- $I_{OL}$  Output LOW current, forced into the output in  $V_{OL}$  test.
- $I_{RH}$  Reverse input load current.
- Negative Current** Current flowing out of the device.
- Positive Current** Current flowing into the device.
- $V_{IH}$  Minimum logic HIGH input voltage. Refer to figure 2.
- $V_{IL}$  Maximum logic LOW input voltage. Refer to figure 2.
- $V_{OH}$  Minimum logic HIGH output voltage with output HIGH current  $I_{OH}$  flowing out of output.
- $V_{OL}$  Maximum logic LOW output voltage with output LOW current  $I_{OL}$  into output.

### FUNCTIONAL TERMS:

- $\bar{C}_0$  The asynchronous direct clear input. A LOW on this input resets the monostable independent of other conditions.
- Fan-Out** The logic HIGH or LOW output drive capability in terms of Input Unit Loads.
- $\bar{I}_0$  The active LOW input of the monostables. With input I, LOW a HIGH to LOW transition on  $\bar{I}_0$  will cause triggering.
- $I_1$  The active HIGH input of the monostables. With  $\bar{I}_1$  HIGH a LOW to HIGH transition on  $I_1$  will cause triggering.
- Input Unit Load** One TTL gate input load.
- Q** The TRUE output of the monostables.
- $\bar{Q}$  The FALSE output of the monostables.
- Triggering** The switching of the monostable from the stable state to the unstable state and start of the timing cycle.

### SWITCHING TERMS:

- $t_{pd+}$  The propagation delay from a HIGH to LOW transition on  $\bar{I}_0$  to the true (Q) output LOW to HIGH transition.
- $t_{pd-}$  The propagation delay from a HIGH to LOW transition on  $\bar{I}_0$  to the false ( $\bar{Q}$ ) output HIGH to LOW transition.
- $t_{pL}(\text{min})$  The minimum true (Q) output pulse width with  $R_x = 5$  k $\Omega$ ,  $C_x = 0$  pF.
- $t_{pw}$  The pulse width obtained with  $R_x = 10$  k $\Omega$ ,  $C_x = 1000$  pF.
- $\Delta t_{pw}(T)$  The maximum percentage change in pulse width of the true (Q) output for the Am2602 over the temperature range from the pulse width at 25°C.

**Am 2602**  
**Normalized Output**  
**Pulse Width Versus**  
**Ambient Temperature**

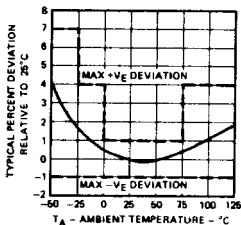
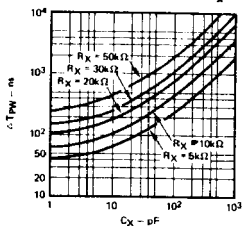

Figure 1

**Output Pulse Width ( $\Delta T_{PW}$ )**  
**Using Low Values of  $C_X$**



NOTE: Above  $C_X = 10^3$  pF Use  $\Delta T_{PW} = 0.32 C_X R_X (1+0.7/R_X)$

Figure 2

**SWITCHING TIME TEST CIRCUIT AND WAVEFORMS**

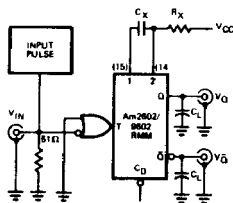

$V_{CC} = \text{Pin } 16$   
 $\text{Gnd.} = \text{Pin } 8$

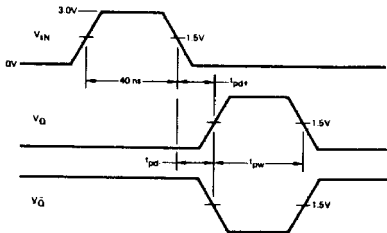

**INPUT PULSE**  
 $f = 100 \text{ kHz}$   
 $C_D = 5 \text{ pF}$   
 Width = 40 ns  
 $t_r = t_f \leq 10 \text{ ns}$

Figure 3

**TRUTH TABLE**  
Am2602/9602  
For Each Monostable

$\bar{I}_b$	$I_i$	$\bar{C}_D$	Operation
H→L	L	H	Trigger
H	L→H	H	Trigger
X	X	L	Reset

H = HIGH Voltage Level  
L = LOW Voltage Level  
X = Don't Care  
H→L = HIGH to LOW Voltage Level transition  
L→H = LOW to HIGH Voltage Level transition

Table I

**MSI INTERFACING RULES**

Interfacing Digital Family	Equivalent Input Unit Load	
	HIGH	LOW
Advanced Micro Devices 9300/2500 Series	1	1
FSC Series 9300	1	1
Ti Series 54/7400	1	1
Signetics Series 8200	2	2
National Series DM 75/85	1	1
DTL Series 930	12	1

Table III

**Am2602/9602 LOADING RULES**

Input/Output	Pin No.'s	Input Unit Load	Fanout	
			Output HIGH	Output LOW
Monostable 1	$C_x$	1	—	—
	$C_x R_x$	2	—	—
	$\bar{C}_D$	3	1	—
	$I_i$	4	1	—
	$\bar{I}_b$	5	1	—
	Q	6	—	16
	$\bar{Q}$	7	—	16
	GND	8	—	—
Monostable 2	$\bar{Q}$	9	—	16
	Q	10	—	16
	$\bar{I}_b$	11	1	—
	$I_i$	12	1	—
	$\bar{C}_D$	13	1	—
	$C_x R_x$	14	—	—
	$C_x$	15	—	—
	$V_{CC}$	16	—	—

Table II

**INPUT/OUTPUT INTERFACE CONDITIONS**

**Voltage Interface Conditions — LOW & HIGH**

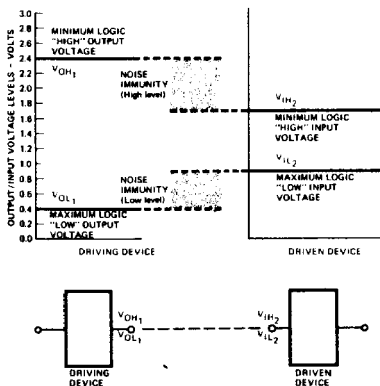
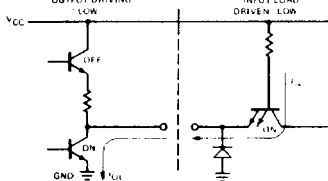
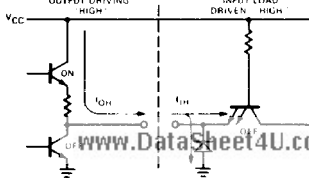

Figure 4

**Current Interface Conditions — LOW**



**Current Interface Conditions — HIGH**



# Am2602/9602 APPLICATIONS

www.DataSheet4U.com

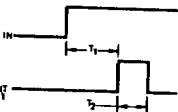
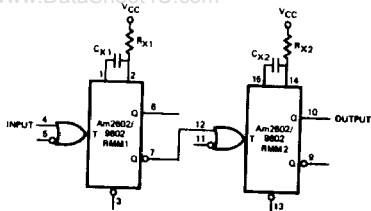

**Delayed Pulse Generation**

Figure 5

The first monostable determines the time  $T_1$  before the initiation of the output pulse. The second monostable determines  $T_2$ , the output pulse width.

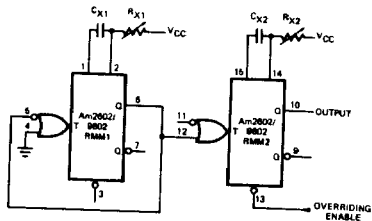

**Pulse Generator**

Figure 6

The output frequency produced with the above configuration is determined by  $C_{X1}$  and  $R_{X1}$ , while the pulse width is determined by  $C_{X2}$  and  $R_{X2}$ . Monostable 1 forms an astable multivibrator with an output pulse width of approximately 25 ns, while monostable 2 extends the pulse width to the required value.

## PHYSICAL DIMENSIONS Dual-In-Line

Hermetic

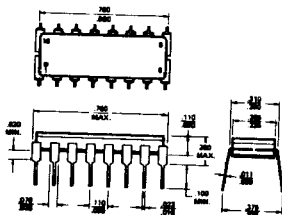

Molded

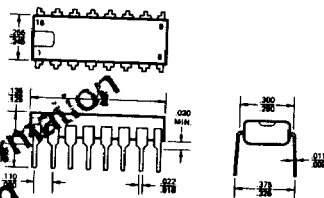

Flat Package

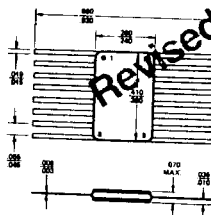

Metalization and Pad Layout

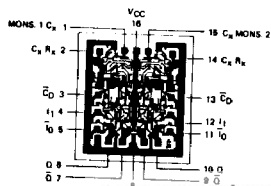

www.DataSheet4U.com



**ADVANCED  
MICRO  
DEVICES INC.**  
901 Thompson Place  
Sunnyvale  
California 94088  
(408) 732-2400  
TWX: 910-339-9280  
TELEX: 34-6306

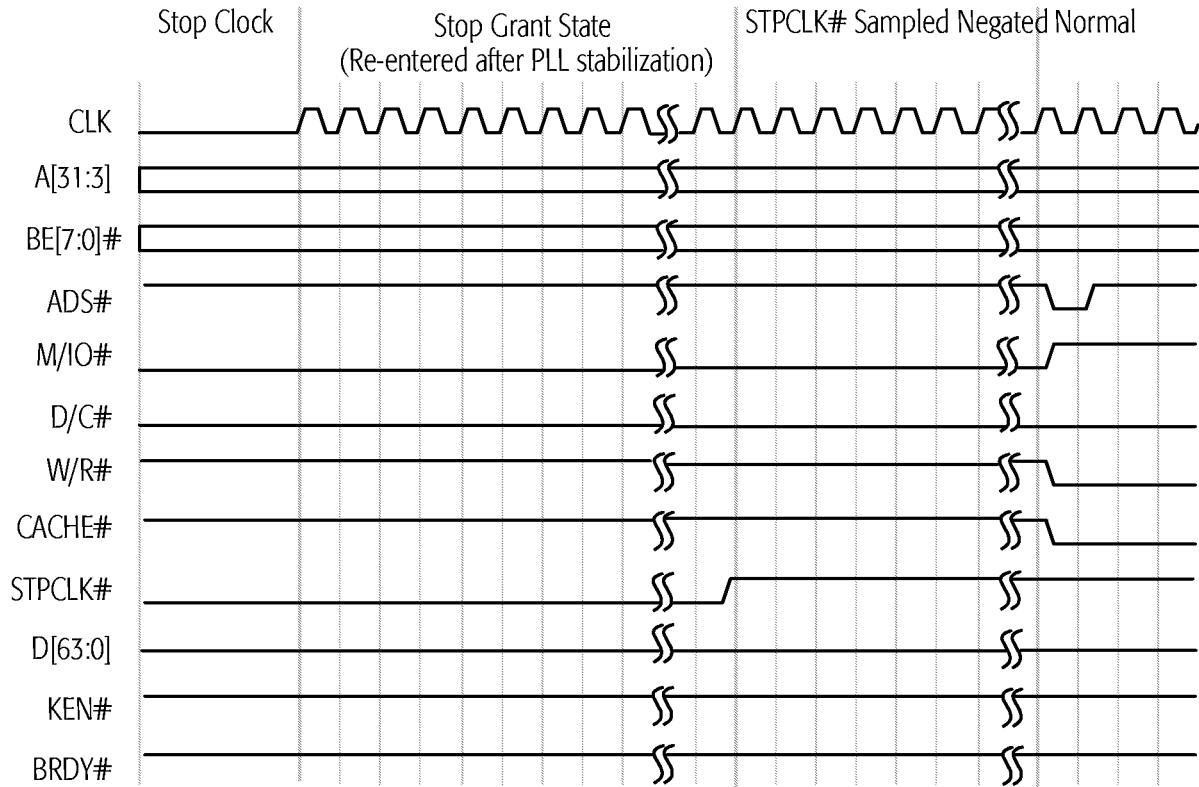

Figure 75. Stop Grant and Stop Clock Modes, Part 2

**INIT-Initiated  
Transition from  
Protected Mode to  
Real Mode**

INIT is typically asserted in response to a BIOS interrupt that writes to an I/O port. This interrupt is often in response to a Ctrl-Alt-Del keyboard input. The BIOS writes to a port (similar to port 64h in the keyboard controller) that asserts INIT. INIT is also used to support 80286 software that must return to Real mode after accessing extended memory in Protected mode.

The assertion of INIT causes the processor to empty its pipelines, initialize most of its internal state, and branch to address FFFF\_FFF0h—the same instruction execution starting point used after RESET. Unlike RESET, the processor preserves the contents of its caches, the floating-point state, the MMX state, Model-Specific Registers (MSRs), the CD and NW bits of the CR0 register, the time stamp counter, and other specific internal resources.

Figure 76 shows an example in which the operating system writes to an I/O port, causing the system logic to assert INIT. The sampling of INIT asserted starts an extended microcode sequence that terminates with a code fetch from FFFF\_FFF0h, the reset location. INIT is sampled on every clock edge but is not recognized until the next instruction boundary. During an I/O write cycle, it must be sampled asserted a minimum of three clock edges before BRDY# is sampled asserted if it is to be recognized on the boundary between the I/O write instruction and the following instruction. If INIT is asserted synchronously, it can be asserted for a minimum of one clock. If it is asserted asynchronously, it must have been negated for a minimum of two clocks, followed by an assertion of a minimum of two clocks.



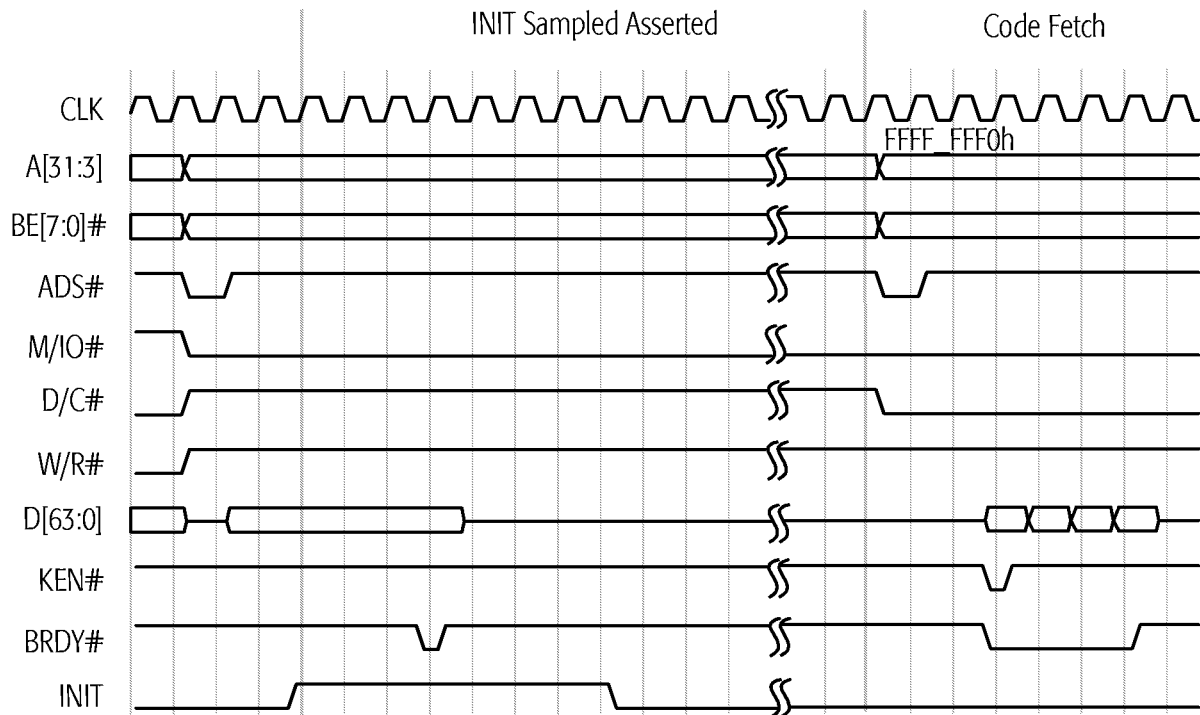

**Figure 76. INIT-Initiated Transition from Protected Mode to Real Mode**



## 6 Power-on Configuration and Initialization

On power-on the system logic must reset the AMD-K6-2 processor by asserting the RESET signal. When the processor samples RESET asserted, it immediately flushes and initializes all internal resources and its internal state, including its pipelines and caches, the floating-point state, the MMX and 3DNow! states, and all registers. Then the processor jumps to address FFFF\_FFF0h to start instruction execution.

### 6.1 Signals Sampled During the Falling Transition of RESET

**FLUSH#** FLUSH# is sampled on the falling transition of RESET to determine if the processor begins normal instruction execution or enters Tri-State Test mode. If FLUSH# is High during the falling transition of RESET, the processor unconditionally runs its Built-In Self Test (BIST), performs the normal reset functions, then jumps to address FFFF\_FFF0h to start instruction execution. (See “Built-In Self-Test (BIST)” on page 217 for more details.) If FLUSH# is Low during the falling transition of RESET, the processor enters Tri-State Test mode. (See “Tri-State Test Mode” on page 218 and “FLUSH# (Cache Flush)” on page 103 for more details.)

**BF[2:0]** The internal operating frequency of the processor is determined by the state of the bus frequency signals BF[2:0] when they are sampled during the falling transition of RESET. The frequency of the CLK input signal is multiplied internally by a ratio defined by BF[2:0]. (See “BF[2:0] (Bus Frequency)” on page 92 for the processor-clock to bus-clock ratios.)

**BRDYC#** BRDYC# is sampled on the falling transition of RESET to configure the drive strength of A[20:3], ADS#, HITM#, and W/R#. If BRDYC# is Low during the fall of RESET, these outputs are configured using higher drive strengths than the standard strength. If BRDYC# is High during the fall of RESET, the standard strength is selected. (See “BRDYC# (Burst Ready Copy)” on page 95 for more details.)

## 6.2 RESET Requirements

During the initial power-on reset of the processor, RESET must remain asserted for a minimum of 1.0 ms after CLK and V<sub>CC</sub> reach specification. (See “CLK Switching Characteristics” on page 255 for clock specifications. See “Electrical Data” on page 247 for V<sub>CC</sub> specifications.)

During a warm reset while CLK and V<sub>CC</sub> are within specification, RESET must remain asserted for a minimum of 15 clocks prior to its negation.

## 6.3 State of Processor After RESET

### Output Signals

Table 31 shows the state of all processor outputs and bidirectional signals immediately after RESET is sampled asserted.

**Table 31. Output Signal State After RESET**

Signal	State	Signal	State
A[31:3], AP	Floating	LOCK#	High
ADS#, ADSC#	High	M/IO#	Low
APCHK#	High	PCD	Low
BE[7:0]#	Floating	PCHK#	High
BREQ	Low	PWT	Low
CACHE#	High	SCYC	Low
D/C#	Low	SMIACT#	High
D[63:0], DP[7:0]	Floating	TDO	Floating
FERR#	High	VCC2DET	Low
HIT#	High	VCC2H/L#	Low
HITM#	High	W/R#	Low
HLDA	Low	—	—

### Registers

Table 32 on page 175 shows the state of all architecture registers and Model-Specific Registers (MSRs) after the processor has completed its initialization due to the recognition of the assertion of RESET.