

FMM5063X

Ku-Band Power Amplifier MMIC

FEATURES

- High Output Power; P1dB = 32.0 dBm (Typ.)
- High Linear Gain; GL = 30 dB(Typ)
- Wide Frequency Band : 12.75 - 15.4 GHz
- Impedance Matched Zin/Zout = 50Ω

DESCRIPTION

The FMM5063X is a power amplifier MMIC that contains a three stage amplifier, internally matched, for standard communications band in 12.75 to 15.4GHz frequency range. This product is well suited for point-to-point radio and V-SAT.

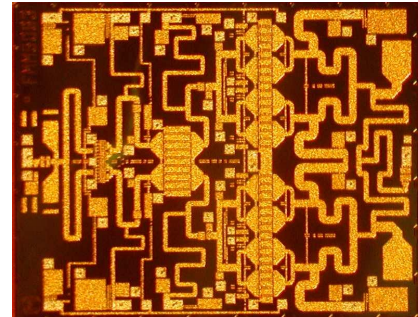

Eudyna's stringent Quality Assurance Program assures the highest reliability and consistent performance.

ABSOLUTE MAXIMUM RATING (Ambient Temperature Ta=25 °C)

Item	Stmbol	Condition	Rating	Unit
Drain-Source Voltage	VDD		10	V
Gate-Source Voltage	VGG		-3	V
Input Power	Pin		24	dBm
Strage Temperature	Tstg		-55 to +125	°C

RECOMMENDED OPERATING CONDITION

Item	Symbol	Condition	Recommended	Unit
Drain-Source Voltage	VDD		≤ 8	V
Input Power	Pin		≤ 9	dBm
Operating Backside Temperature	Top		-40 to +85	°C

This product should be hermetically packaged.

ELECTRICAL CHARACTERISTICS (Ambient Temperature Ta=25 °C)

Item	Symbol	Test Conditions	Limits			Unit
			Min.	Typ.	Max.	
Frequency Range	f	VDD=6.0V	12.75	-	15.4	GHz
Output Power at 1dB G.C.P.	P1dB	IDD(DC)=900mA typ.	30.0	32.0	-	dBm
Power Gain at 1dB G.C.P.	G1dB	Zs=Zl=50ohm	25	29	-	dB
Power Added Efficiency at 1dB G.C.P.	Nadd		-	22	-	%
Third Order Intermodulation	IM3*	*df=10MHz,Po=20dBm	-32	-37	-	dBc
Drain Current at 1dB G.C.P.	Iddrf	(S.C.L.)	-	1000	1500	mA
Input Return Loss at Pin=-20dBm	RLin		-	-8	-	dB
Output Return Loss at Pin=-20dBm	RLout		-	-12	-	dB

Note : RF parameter sample size 10ps. Criteria (accept/reject)=(0/1)

G.C.P. : Gain Compression Point
S.C.L. : Single Carrier Level

ESD	Class 0	~ 199V
------------	----------------	---------------

Note : Based on EIAJ ED-4701 C-111A(C=100pF, R=1.5kW)

FMM5063X

Ku-Band Power Amplifier MMIC

Output Power vs. Frequency

VDD=6V, IDD(DC)=900mA

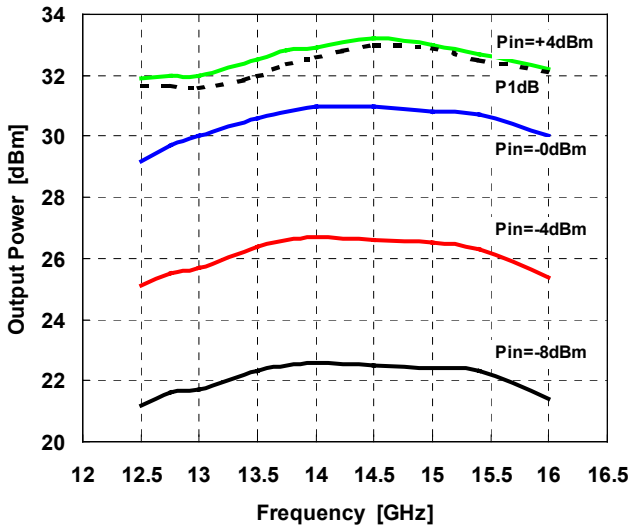

Output Power, Drain Current vs. Input Power

VDD=6V, IDD(DC)=900mA

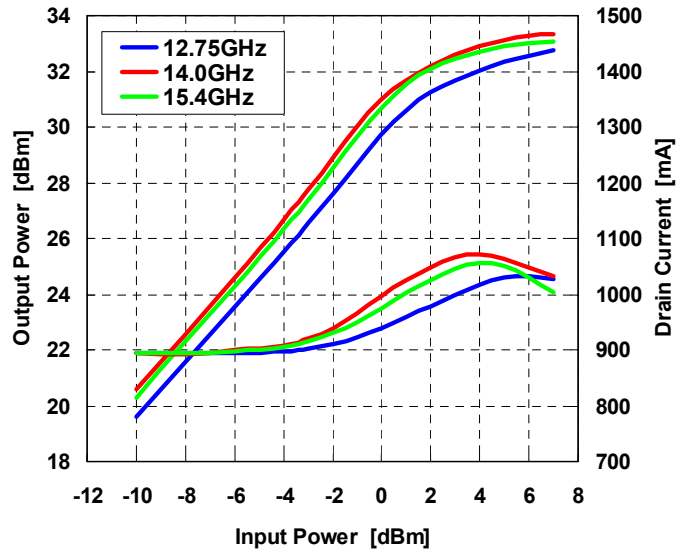

Power Added Efficiency vs. Frequency

VDD=6V, IDD(DC)=900mA

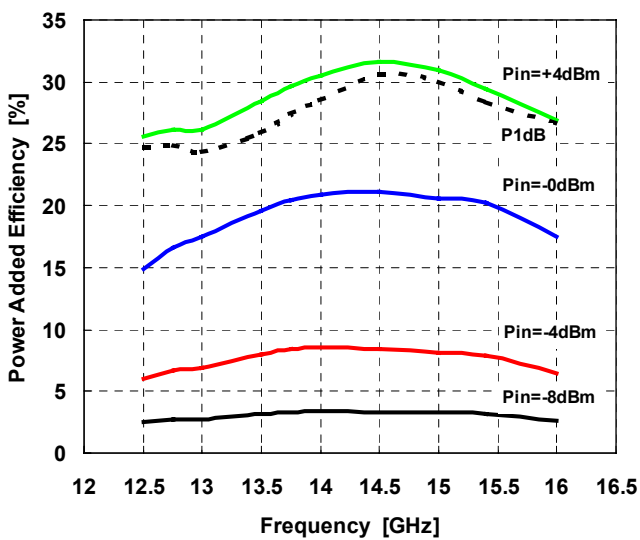

FMM5063X

Ku-Band Power Amplifier MMIC

IMD vs. Frequency

VDD=6V, IDD(DC)=900mA, Pout=20dBm S.C.L.

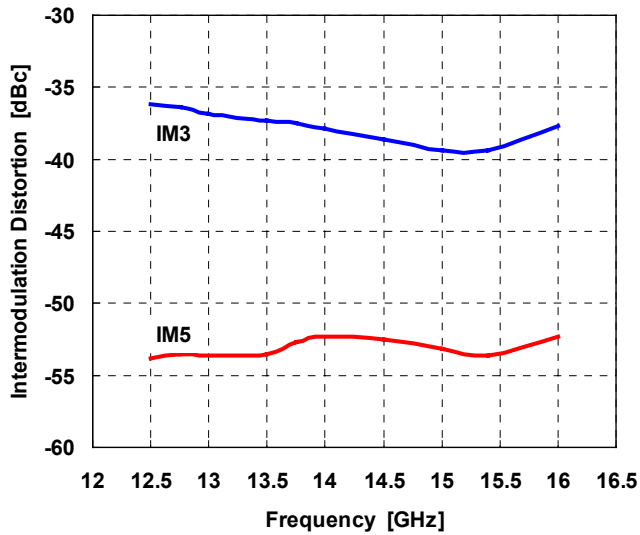

IMD vs. Output Power

VDD=6V, IDD(DC)=900mA

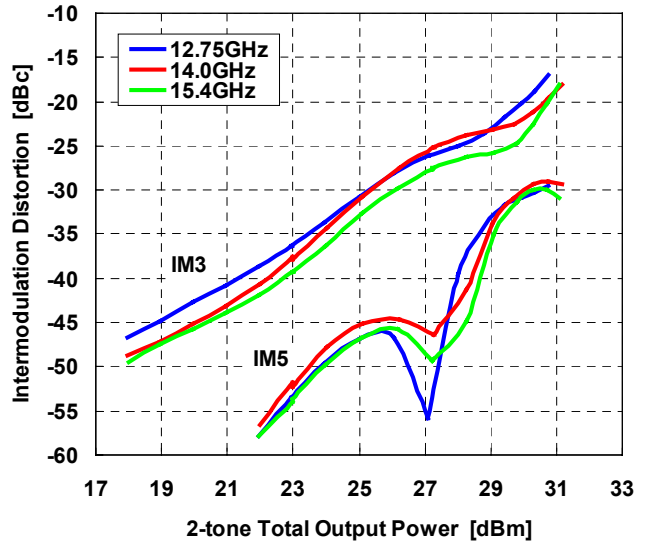

FMM5063X

Ku-Band Power Amplifier MMIC

Output Power, Drain Current vs. Input Power by Drain Voltage

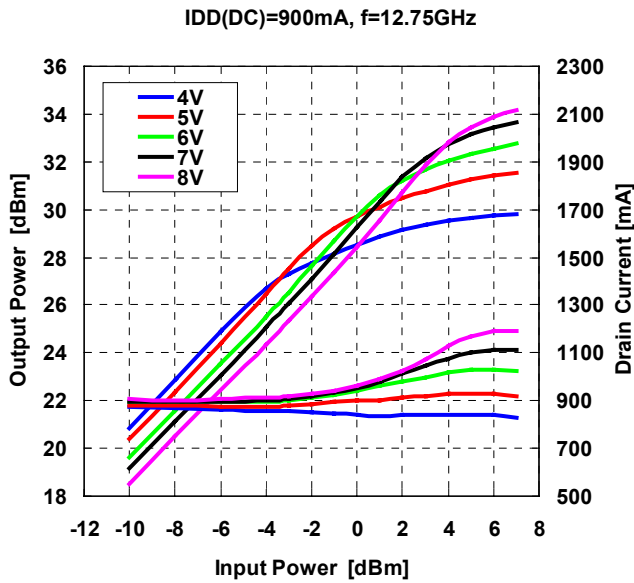

Output Power, Drain Current vs. Input Power by Drain Voltage

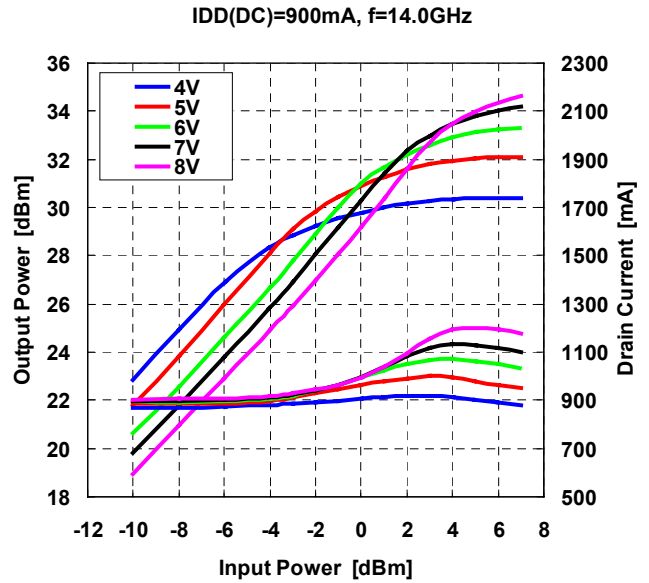

Output Power, Drain Current vs. Input Power by Drain Voltage

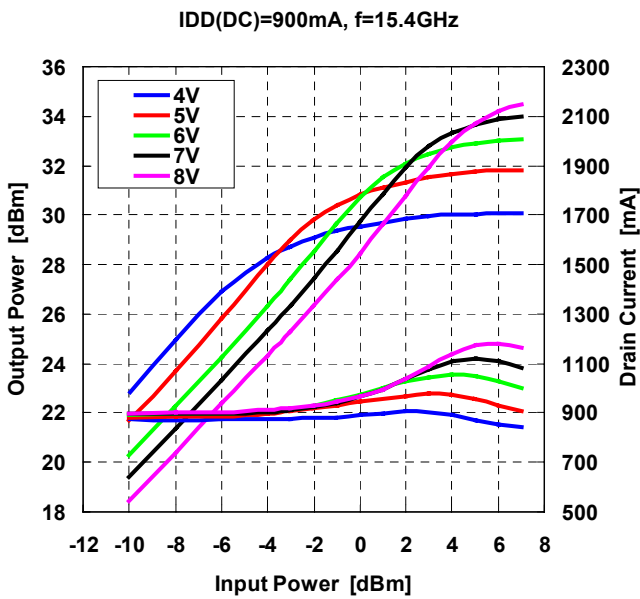

Output Power, Gain vs. Drain Voltage

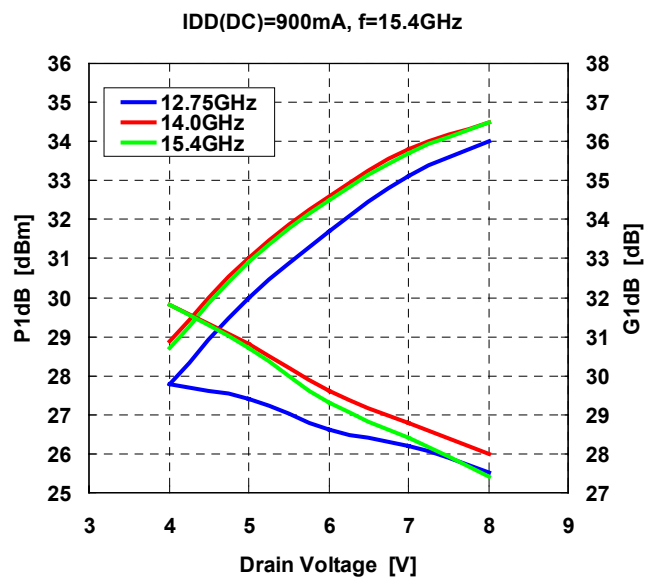

FMM5063X

Ku-Band Power Amplifier MMIC

Output Power, Drain Current
vs. INPUT POWER by Drain Current

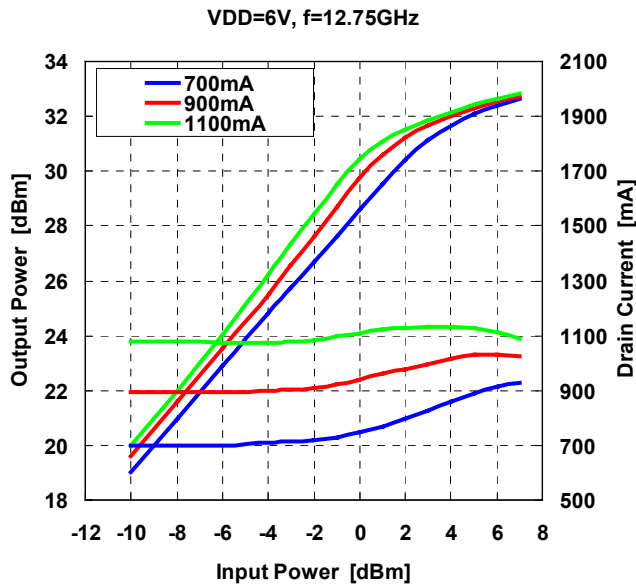

Output Power, Drain Current
vs. INPUT POWER by Drain Current

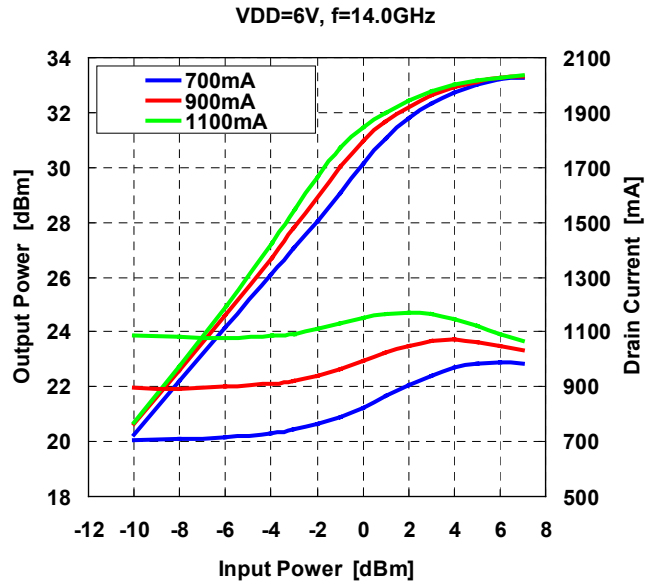

Output Power, Drain Current
vs. INPUT POWER by Drain Current

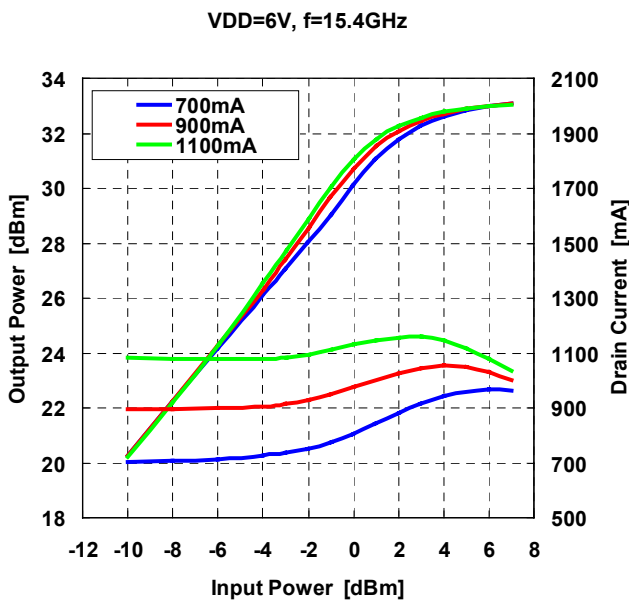

Output Power, Gain vs. Drain Current

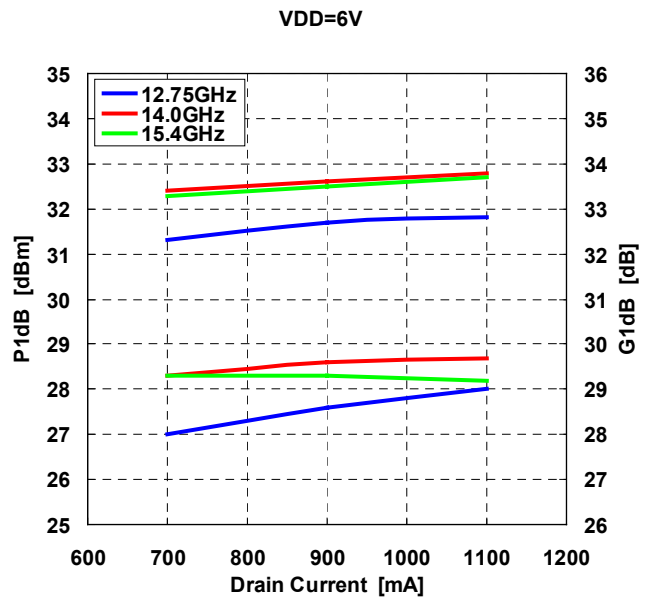

FMM5063X

Ku-Band Power Amplifier MMIC

IMD vs. OUTPUT POWER
by Drain Voltage

IDD(DC)=900mA, f=12.75GHz

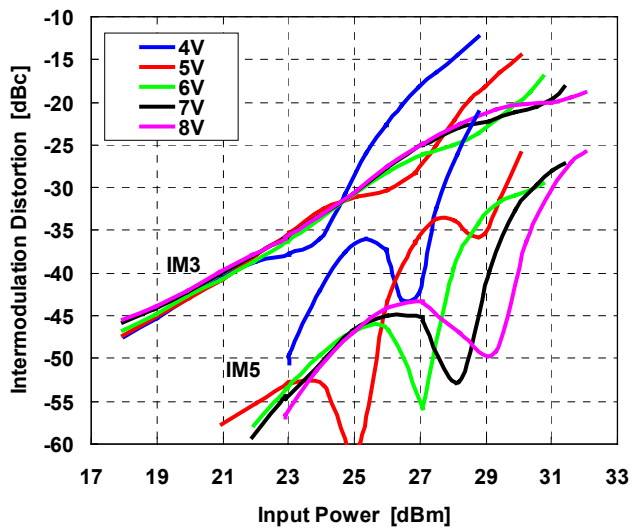

IMD vs. OUTPUT POWER
by Drain Voltage

IDD(DC)=900mA, f=14.0GHz

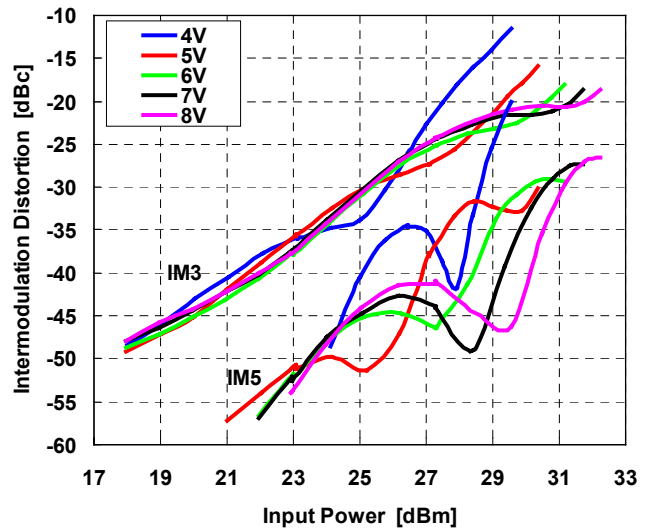

IMD vs. OUTPUT POWER
by Drain Voltage

IDD(DC)=900mA, f=15.4GHz

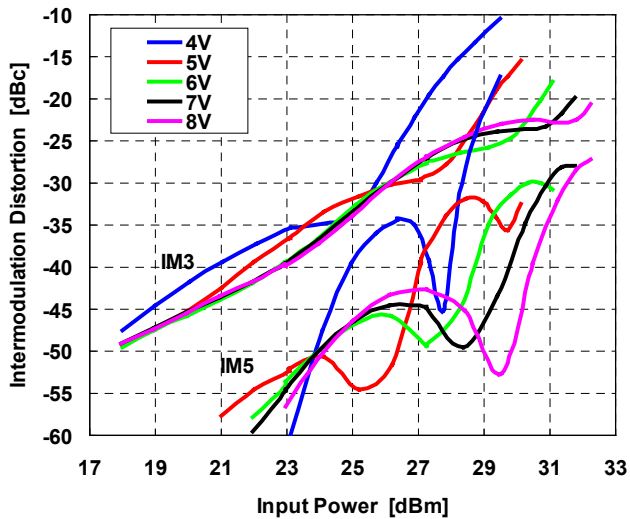

FMM5063X

Ku-Band Power Amplifier MMIC

**IMD vs. OUTPUT POWER
by Drain Current**

VDD=6V, f=12.75GHz

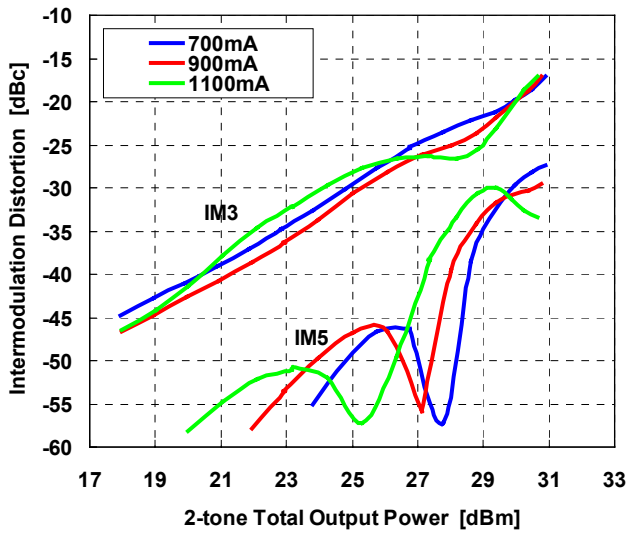

**IMD vs. OUTPUT POWER
by Drain Current**

VDD=6V, f=14.0GHz

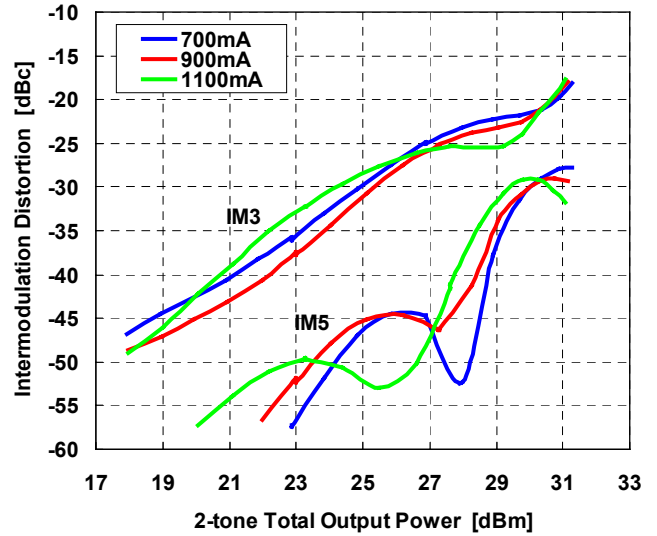

**IMD vs. OUTPUT POWER
by Drain Current**

VDD=6V, f=15.4GHz

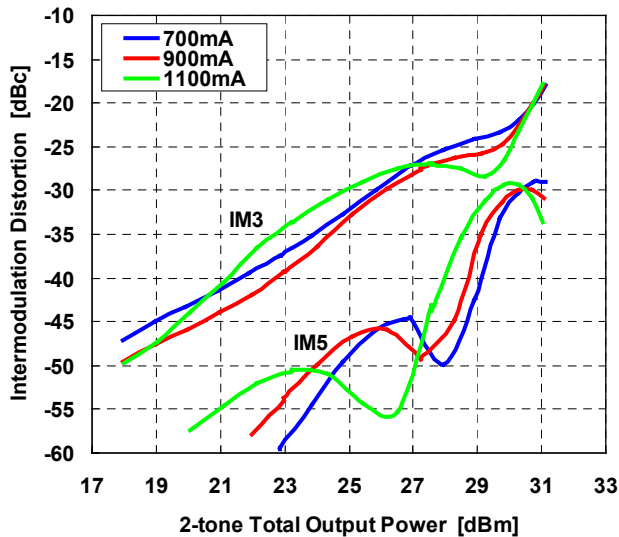

FMM5063X

Ku-Band Power Amplifier MMIC

■ S-PARAMETER

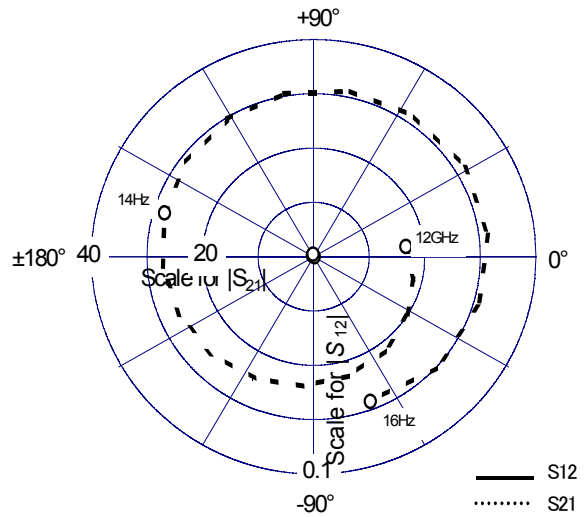
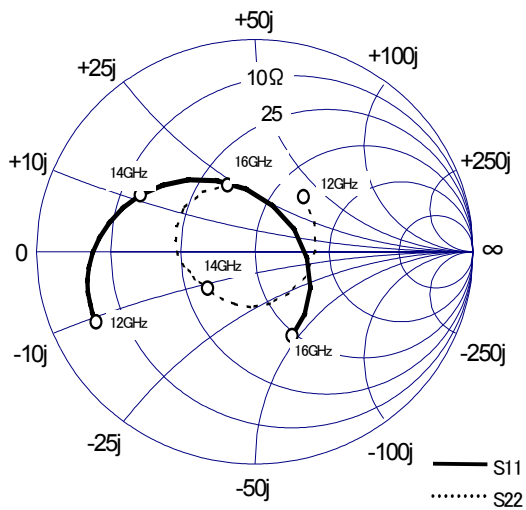

FMM5063X

Ku-Band Power Amplifier MMIC

■ S-PARAMETER

VDD=6V, IDD=900mA

Frequency [GHz]	S11		S21		S12		S22	
	MAG	ANG	MAG	ANG	MAG	ANG	MAG	ANG
1.0	0.58	-29.2	0.01	132.2	0.00	-148.2	1.00	-30.2
2.0	0.57	-42.7	0.07	-14.0	0.00	-95.8	0.97	-60.9
3.0	0.59	-57.2	0.08	-163.4	0.00	-152.7	0.96	-88.1
4.0	0.62	-70.5	0.05	169.5	0.00	36.6	0.96	-119.3
5.0	0.66	-82.8	0.10	-157.9	0.00	-99.4	0.92	-153.1
6.0	0.69	-94.0	0.57	137.7	0.00	145.6	0.83	170.2
7.0	0.73	-105.0	1.59	65.8	0.00	128.2	0.71	123.2
8.0	0.75	-115.4	3.64	-29.5	0.00	10.3	0.49	49.6
9.0	0.76	-123.8	5.00	-119.1	0.00	-67.9	0.43	-67.8
10.0	0.78	-132.7	6.54	164.2	0.00	-104.4	0.53	-158.1
11.0	0.80	-143.0	9.79	91.3	0.00	-175.6	0.51	134.5
12.0	0.80	-155.5	16.72	6.4	0.00	137.7	0.34	49.2
12.2	0.80	-158.6	18.43	-13.0	0.00	103.1	0.30	26.6
12.4	0.79	-162.0	20.09	-33.1	0.00	127.8	0.28	0.7
12.6	0.79	-165.8	21.57	-53.6	0.00	92.8	0.26	-26.6
12.8	0.78	-170.0	22.85	-74.3	0.00	88.2	0.25	-51.8
13.0	0.76	-174.6	23.90	-94.9	0.00	108.5	0.25	-74.3
13.2	0.74	-179.7	24.82	-115.5	0.00	56.1	0.26	-94.7
13.4	0.72	174.6	25.64	-135.8	0.00	27.2	0.26	-110.7
13.6	0.68	168.4	26.41	-156.0	0.00	49.2	0.27	-123.0
13.8	0.64	161.2	27.17	-176.3	0.00	15.6	0.27	-133.8
14.0	0.59	152.9	28.00	163.3	0.00	3.1	0.28	-141.7
14.2	0.53	143.3	28.82	142.7	0.00	-17.6	0.29	-147.8
14.4	0.46	131.7	29.71	121.5	0.00	-52.1	0.30	-155.0
14.6	0.38	117.3	30.51	99.9	0.00	-34.7	0.31	-162.1
14.8	0.30	97.7	31.16	77.6	0.00	-115.4	0.33	-168.4
15.0	0.23	69.1	31.60	54.7	0.00	-136.6	0.35	-177.7
15.2	0.21	30.6	31.80	31.2	0.00	145.0	0.36	172.0
15.4	0.24	-6.8	31.64	7.2	0.00	166.5	0.38	161.4
15.6	0.31	-33.5	31.10	-17.5	0.00	153.5	0.38	147.0
15.8	0.37	-52.3	30.12	-43.0	0.00	123.9	0.37	130.0
16.0	0.43	-66.5	28.53	-69.0	0.00	104.3	0.34	111.6
17.0	0.55	-97.6	14.50	164.0	0.00	-19.5	0.29	-34.6
18.0	0.65	-107.2	5.42	61.8	0.00	-98.3	0.51	-112.7
19.0	0.74	-116.4	2.25	-25.6	0.00	152.2	0.71	-150.9
20.0	0.79	-123.6	1.07	-127.3	0.00	165.1	0.82	-177.6
21.0	0.84	-130.0	0.20	117.7	0.00	-176.2	0.87	159.5
22.0	0.86	-136.1	0.03	56.9	0.00	91.7	0.92	140.5
23.0	0.87	-140.9	0.00	94.4	0.00	98.7	0.94	124.6
24.0	0.88	-144.6	0.00	80.0	0.00	65.9	0.93	108.6
25.0	0.88	-148.2	0.00	69.8	0.00	66.2	0.93	91.3
26.0	0.89	-150.9	0.00	62.1	0.00	27.9	0.93	73.6
27.0	0.90	-154.0	0.00	17.8	0.00	41.2	0.87	50.3
28.0	0.90	-156.6	0.00	3.2	0.00	-16.8	0.77	14.1
29.0	0.91	-159.7	0.00	31.5	0.00	-14.0	0.63	-44.3
30.0	0.92	-161.9	0.00	131.7	0.00	27.1	0.60	-132.2
31.0	0.92	-164.8	0.00	8.4	0.00	147.7	0.79	169.8
32.0	0.92	-167.9	0.00	145.0	0.00	15.4	0.86	136.0
33.0	0.92	-170.8	0.00	49.5	0.00	14.4	0.92	113.1
34.0	0.91	-174.1	0.00	39.1	0.00	-25.8	0.96	99.9
35.0	0.90	-177.1	0.00	16.1	0.00	118.9	0.95	88.2
36.0	0.87	179.5	0.00	-25.3	0.00	-53.4	0.94	75.7
37.0	0.85	175.7	0.00	-12.7	0.00	-61.3	0.96	68.3
38.0	0.79	172.2	0.00	-142.6	0.00	-56.1	0.98	62.8
39.0	0.74	170.8	0.00	-43.0	0.01	-99.2	0.94	53.3
40.0	0.67	168.9	0.00	-96.1	0.00	-9.9	0.97	44.9

FMM5063X

Ku-Band Power Amplifier MMIC

ΔT_{ch} vs. Drain Voltage
(Reference)

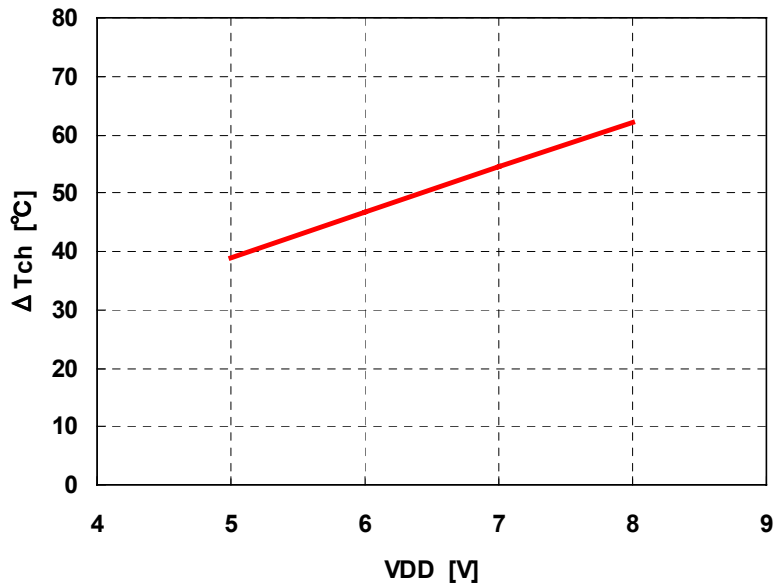

MTTF vs. T_{ch}

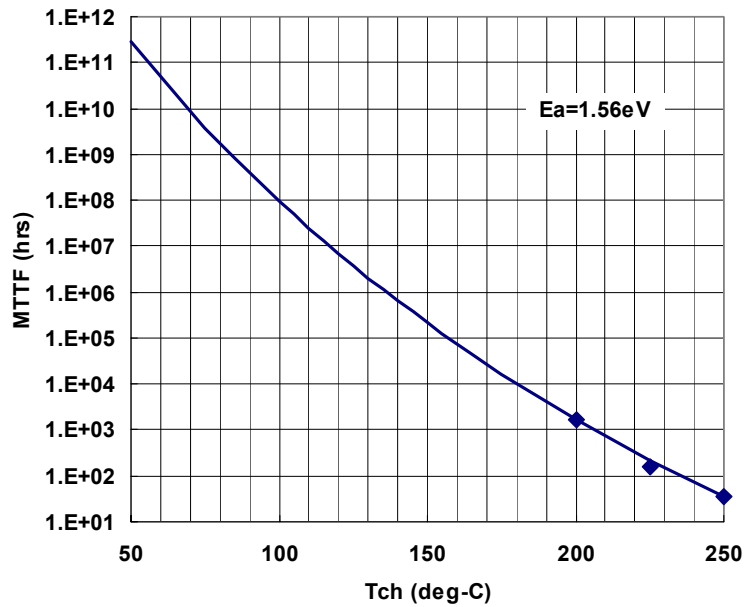

FMM5063X

Ku-Band Power Amplifier MMIC

■ Chip Outline and Bonding Pad Locations (Dimension in Micro-Meters)

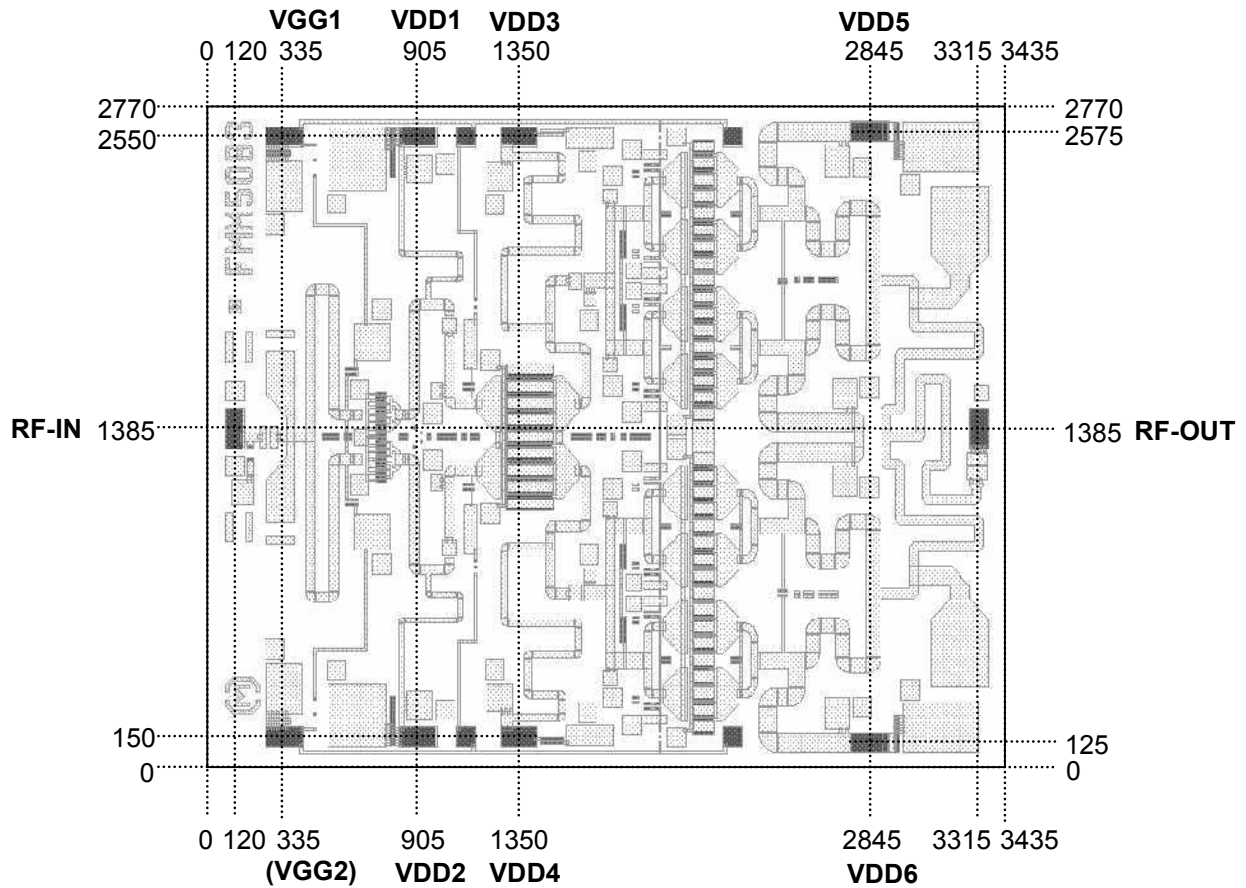

Chip Size : $3435 \pm 30 \mu\text{m} \times 2770 \pm 30 \mu\text{m}$

Chip Thickness : $60 \pm 20 \mu\text{m}$

Bonding Pad Size : $160 \mu\text{m} \times 80 \mu\text{m}$

Note : Gate voltage is required from either or both bonding pad(VGG1 or/and VGG2).

FMM5063X

Ku-Band Power Amplifier MMIC

■ Assembly Diagrams

Recommended assembly

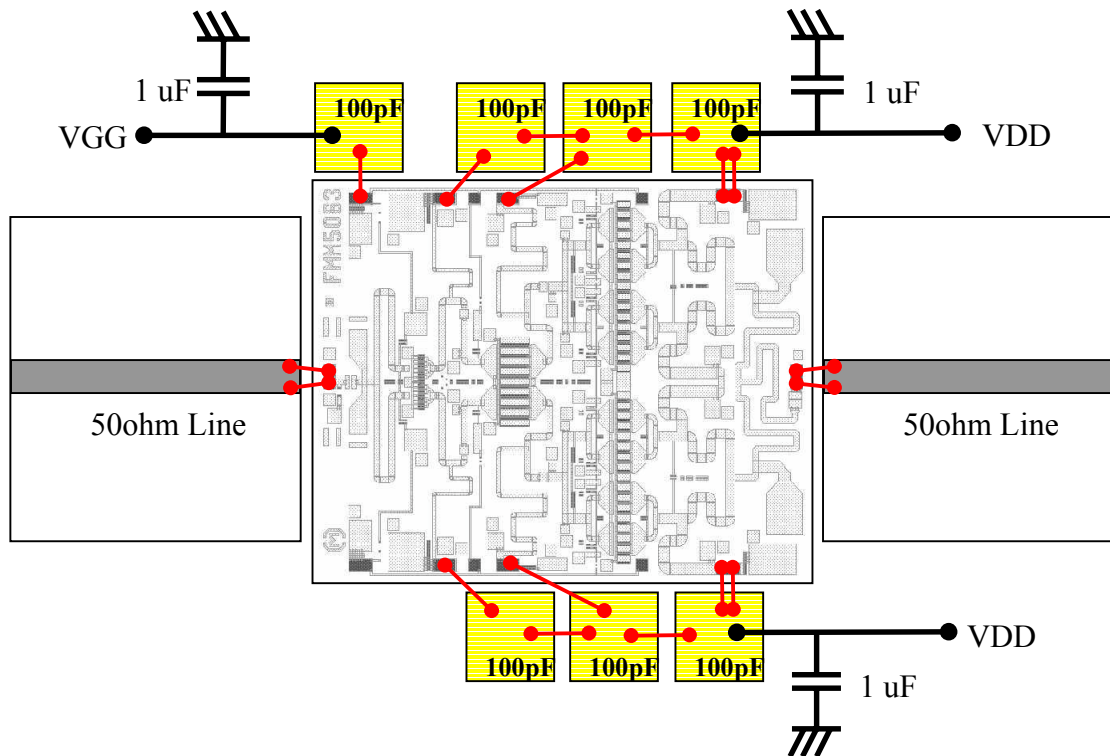

“Copper” is the recommended material for the package or carrier.

FMM5063X

Ku-Band Power Amplifier MMIC

■ DIE ATTACH

- 1) The die-attach station must have accurate temperature control, and an inert forming gas should be used.
- 2) Chips should be kept at room temperature except during die-attach.
- 3) Place package or carrier on the heated stage.
- 4) Lightly grasp the chip edges by the longer side using tweezers.

Die attach conditions

Stage Temperature : 300 to 310 deg.C

Time : less than 15 seconds

AuSn Preform Volume : per next Figure

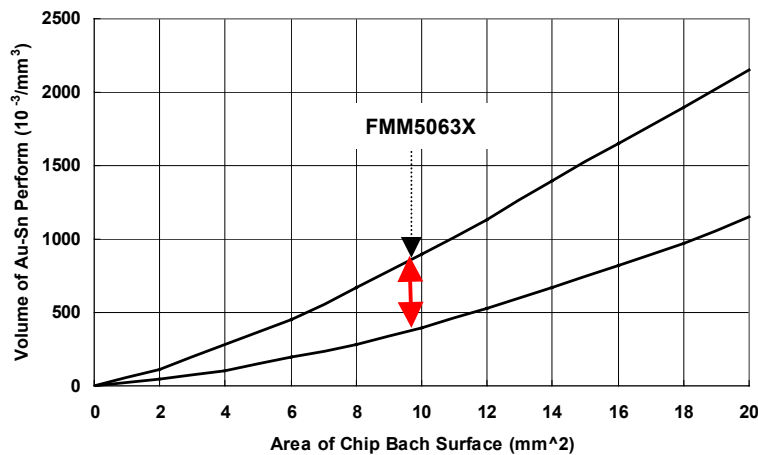

■ WIRE BONDING

The bonding equipment must be properly grounded. The following or equivalent equipment, tools, materials, and conditions are recommended.

1) Bonding Equipment and Bonding Tool.

Bonding Equipment : West Bond Model 7400 (Manual Bonder)

Bonding Tool : CCOD-1/16-S-437-60-F-2010-MP (Deweyl)

2) Bonding Wire

Material : Hard or Half hard gold

Diameter : 0.7 to 1.0 mil

3) Bonding Conditions

Method : Thermal Compression Bonding with Ultrasonic Power

Tool Force : $0.196 \text{ N} \pm 0.0196 \text{ N}$

Stage Temperature : $215 \text{ deg.C} \pm 5 \text{ deg.C}$

Tool Heater : None

Ultrasonic Power Transmitter : West Bond Model 1400

Duration : 150 mS/Bond

FMM5063X

Ku-Band Power Amplifier MMIC

For further information please contact :

Eudyna Devices USA Inc.
2355 Zanker Rd.
San Jose, CA 95131-1138, U.S.A.
TEL: +1 408 232-9500
FAX: +1 408 428-9111

Eudyna Devices Europe Ltd.
Network House
Norreys Drive
Maidenhead, Berkshire SL6 4FJ
United Kingdom
TEL: +44 (0) 1628 504800
FAX: +44 (0) 1628 504888

Eudyna Devices International Srl
Via Teglio 8/2 - 20158
Milano, Italy
TEL: +39-02-8738-1695

Eudyna Devices Asia Pte. Ltd.
Hong Kong Branch
Suite 1906B, Tower 6, China Hong Kong City
33 Canton Road, Tsimshatsui, Kowloon
Hong Kong
TEL: +852-2377-0227
FAX: +852-2377-3921

Eudyna Devices Inc.
1000 Kamisukiahara, showa-cho
Nakakomagun, Yamanashi
409-3883, Japan
(Kokubo Industrial Park)
TEL +81-55-275-4411
FAX +81-55-275-9461

Sales Division
1, Kanai-cho, Sakae-ku
Yokohama, 244-0845, Japan
TEL +81-45-853-8156
FAX +81-45-853-8170

CAUTION

Eudyna Devices Inc. products contain **gallium arsenide (GaAs)** which can be hazardous to the human body and the environment. For safety, observe the following procedures:

- Do not put these products into the mouth.
- Do not alter the form of this product into a gas, powder, or liquid through burning, crushing, or chemical processing as these by-products are dangerous to the human body if inhaled, ingested, or swallowed.
- Observe government laws and company regulations when discarding this product. This product must be discarded in accordance with methods specified by applicable hazardous waste procedures.

Eudyna Devices Inc. reserves the right to change products and specifications without notice. The information does not convey any license under rights of Eudyna Devices Inc. or others.

© 2006 Eudyna Devices Inc.

Eudyna