

Features

- Lead free as standard
- RoHS compliant*
- Low power loss & high efficiency
- High current capability
- Low profile package



The CD2419-B Series is currently available, although not recommended for new designs. The [CD2320-B Series](#) is preferred.

Applications

- AC operated products
- Set top boxes
- Computer monitors
- Cable modems

CD2419-B08200~B08800 Surface Mount Bridge Rectifier Diode

General Information

The markets of portable communications, computing and video equipment are challenging the semiconductor industry to develop increasingly smaller electronic components.

Bourns offers Bridge Rectifier Diodes for rectification applications, in compact chip package 2419 size format, which offer PCB real estate savings and are considerably smaller than most competitive parts. The Bridge Rectifier Diodes offer a forward current of 0.8 A with a choice of repetitive peak reverse voltages between 200 V and 800 V.

Electrical Characteristics (@ T_A = 25 °C Unless Otherwise Noted)

Parameter	Symbol	CD2419-				Unit
		B08200	B08400	B08600	B08800	
Maximum Repetitive Peak Reverse Voltage	V _{RRM}	200	400	600	800	V
Maximum RMS Voltage	V _{RMS}	140	280	420	560	V
Maximum DC Blocking Voltage	V _{DC}	200	400	600	800	V
Maximum Average Forward Rectified Current (T _A = 55°C)	I _(AV)	0.8				A
DC Reverse Current @ Rated DC Blocking Voltage (@T _J = 25 °C)	I _R	5				μA
DC Reverse Current @ Rated DC Blocking Voltage (@T _J = 150 °C)	I _R	200				μA
Typical Junction Capacitance ¹	C _J	25				pF
Maximum Instantaneous Forward Voltage @ 1 A	V _F	1				V
Typical Thermal Resistance ²	R _{θJL}	110				°C/W
Peak forward surge current 8.3 ms single half sine-wave superimposed on rated load (JEDEC Method)	I _{FSM}	35				A

Notes:

1 Measured @ 1.0 MHz and applied reverse voltage of 4.0 VDC.

2 Thermal resistance from junction to ambient and from junction to lead P.C.B. mounted on 0.2" x 0.2" (5.0 mm x 5.0 mm) copper pad areas.

Thermal Characteristics (@ T_A = 25 °C Unless Otherwise Noted)

Parameter	Symbol	CD2419-B08200~B08800	Unit
Operating Temperature Range	T _J	-65 to +175	°C
Storage Temperature Range	T _{STG}	-65 to +175	°C

CD2419-B08200~B08800 Surface Mount Bridge Rectifier Diode



Product Dimensions

This is a lead free product, packaged with FRP substrate and is epoxy underfilled. The terminals are pure tin plated (lead free) and are solderable per MIL-STD-750, Method 2026. The package weighs approximately 0.07 g. The package and dimensions are shown below.

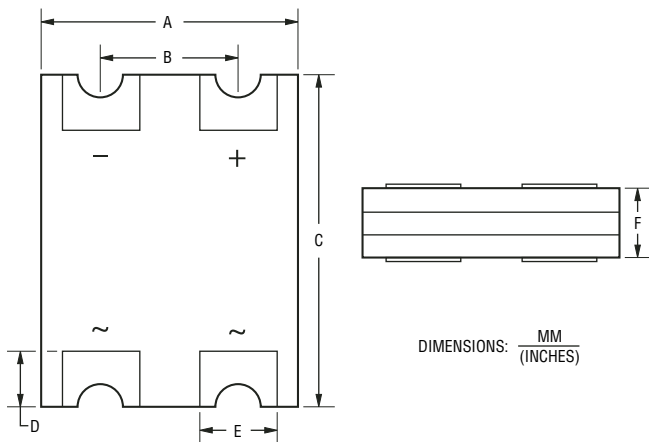

Dimensions	
A	$\frac{4.65 - 4.85}{(0.183 - 0.191)}$
B	$\frac{2.49 - 2.59}{(0.100 - 0.104)}$
C	$\frac{6.05 - 6.25}{(0.238 - 0.246)}$
D	$\frac{0.95 - 1.05}{(0.038 - 0.042)}$
E	$\frac{1.35 - 1.45}{(0.053 - 0.055)}$
F	$\frac{1.10 - 1.30}{(0.043 - 0.051)}$

Recommended Footprint

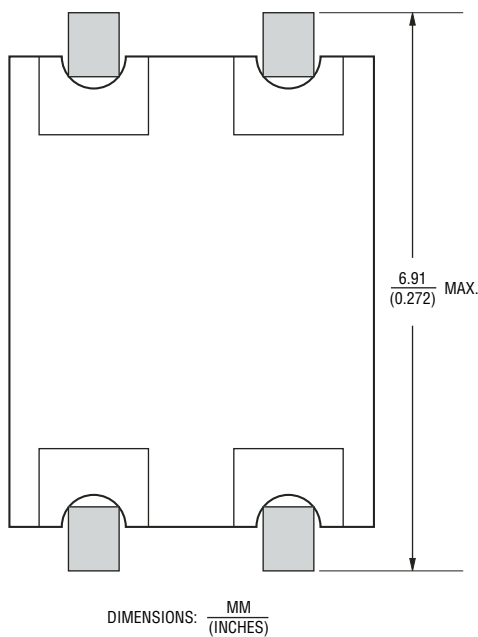

How To Order

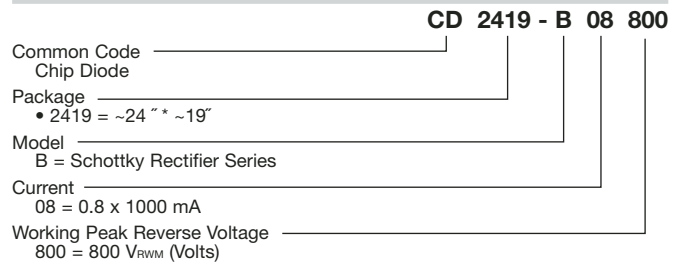

Typical Part Marking

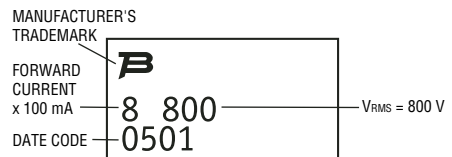

*RoHS Directive 2002/95/EC Jan 27 2003 including Annex Specifications are subject to change without notice. Customers should verify actual device performance in their specific applications.

CD2419-B08200~B08800 Surface Mount Bridge Rectifier Diode



Rating and Characteristic Curves

Forward Current Derating Curve

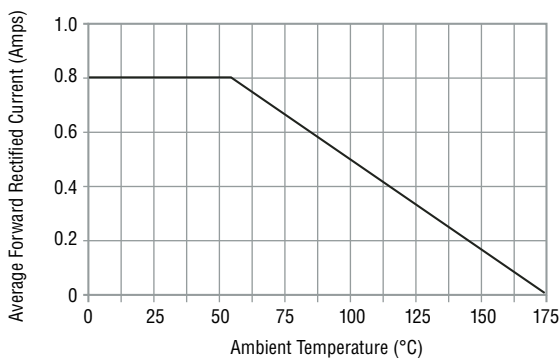

Maximum Non-Repetitive Peak Forward Surge Current

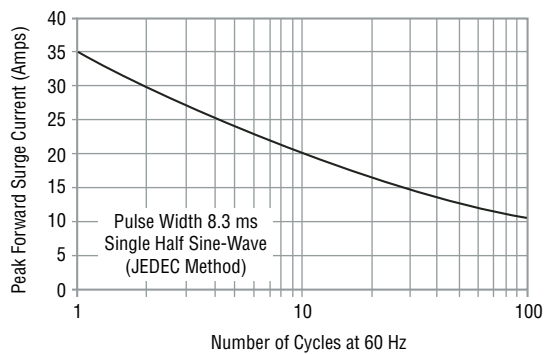

Forward Characteristics

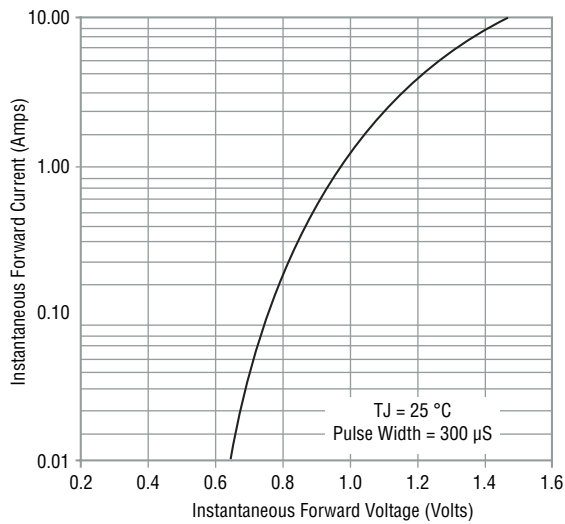

Reverse Characteristics

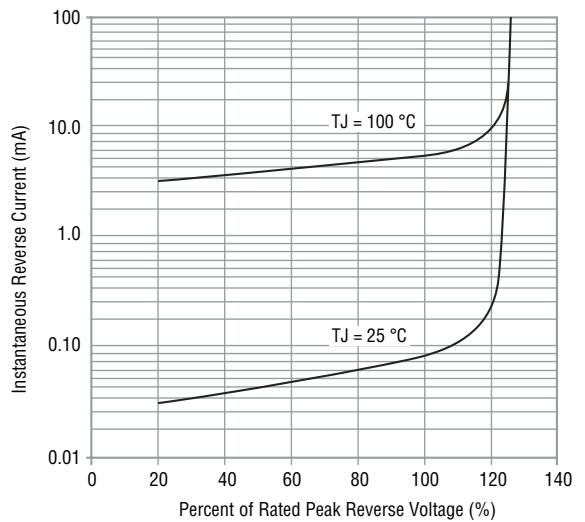

Typical Junction Capacitance

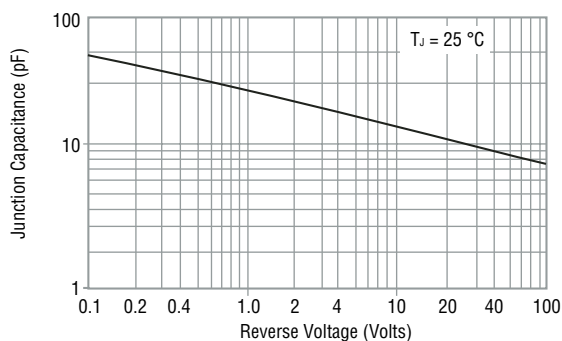

*RoHS Directive 2002/95/EC Jan 27 2003 including Annex Specifications are subject to change without notice. Customers should verify actual device performance in their specific applications.

CD2419-B08200~B08800 Surface Mount Bridge Rectifier Diode

BOURNS®

Packaging Information

The surface mount product is packaged in an 12 mm x 8 mm tape and reel format per EIA-481 standard.

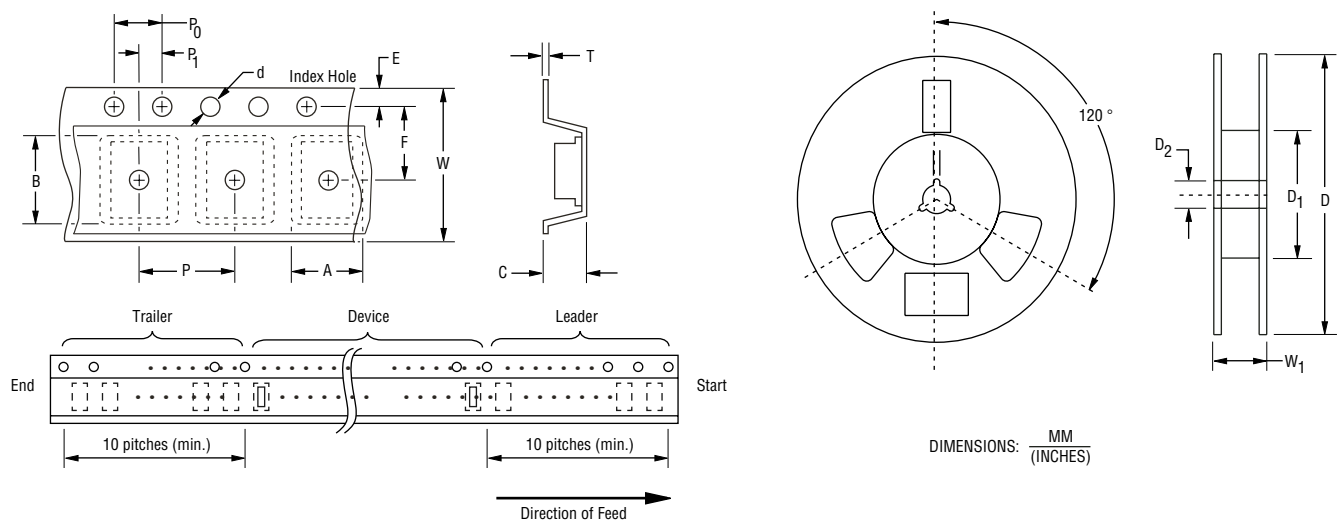

Item	Symbol	2419
Carrier Width	A	$\frac{5.10 \pm 0.10}{(0.200 - 0.004)}$
Carrier Length	B	$\frac{6.50 \pm 0.10}{(0.256 - 0.004)}$
Carrier Depth	C	$\frac{1.50 \pm 0.10}{(0.059 - 0.004)}$
Sprocket Hole	d	$\frac{1.55 \pm 0.05}{(0.061 - 0.002)}$
Reel Outside Diameter	D	$\frac{330}{(12.992)}$
Reel Inner Diameter	D ₁	$\frac{50.0}{(1.969)}$ Min.
Feed Hole Diameter	D ₂	$\frac{13.0 \pm 0.20}{(0.512 - 0.008)}$
Sprocket Hole Position	E	$\frac{1.75 \pm 0.10}{(0.069 - 0.004)}$
Punch Hole Position	F	$\frac{5.50 \pm 0.05}{(0.217 - 0.002)}$
Punch Hole Pitch	P	$\frac{8.00 \pm 0.10}{(0.315 - 0.004)}$
Sprocket Hole Pitch	P ₀	$\frac{4.00 \pm 0.10}{(0.157 - 0.004)}$
Embossment Center	P ₁	$\frac{2.00 \pm 0.05}{(0.079 - 0.002)}$
Overall Tape Thickness	T	$\frac{0.20 \pm 0.10}{(0.008 - 0.004)}$
Tape Width	W	$\frac{12.00 \pm 0.20}{(0.472 - 0.008)}$
Reel Width	W ₁	$\frac{18.7}{(0.736)}$ Max.
Quantity per Reel	—	5,000



Reliable Electronic Solutions

Asia-Pacific:

Tel: +886-2 2562-4117 • Fax: +886-2 2562-4116

Europe:

Tel: +41-41 768 5555 • Fax: +41-41 768 5510

The Americas:

Tel: +1-951 781-5500 • Fax: +1-951 781-5700

www.bourns.com

REV. 07/06

*RoHS Directive 2002/95/EC Jan 27 2003 including Annex Specifications are subject to change without notice. Customers should verify actual device performance in their specific applications.