

Features

- Ultrafast recovery time
- Low forward voltage drop
- Low leakage current
- High reliability by planer design
- Maximum Junction Temperature Range(175°C)

General Description

Winsemi's WSAD92-02 is the state of the art Ultra fast recovery rectifiers specifically designed with optimized performance of forward voltage drop and ultra fast recovery time . The planar structure and the platinum doped life time, control guarantee the best overall performance, ruggedness and reliability characteristics.

Applications

- Switching Power Supplies
- Uninterruptable Power Supplies
- Power Switching Circuits
- General Purpose

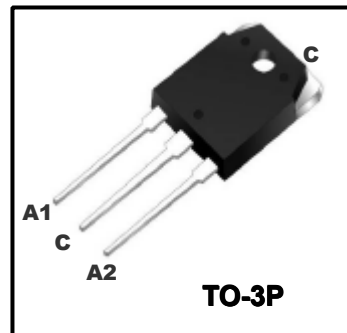
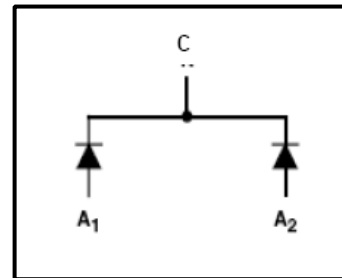

Absolute Maximum Ratings

Symbol	Parameter	Value	Units
V_{RRM}	Peak Repetitive Reverse Voltage	200	V
$I_{F(AV)}$	Average Out Current Square wave, duty=1/2, Tc=115°C	20	A
I_{FSM}	Repetitive Peak Surge Current	100	A
T_{STG}, T_J	Operating Junction Temperature & Storage Temperature	-55~175	°C

Electrical Characteristics ($T_c=25^\circ\text{C}$ unless otherwise noted)

Symbol	Parameter	Test Conditions	Value			Units
			Min	Typ	Max	
V_F	Forward Voltage Drop	$I_F=20\text{A}$	-	-	1.15	V
		$I_F=10\text{A}, T_c=125^\circ\text{C}$	-	-	0.8	V
I_{RRM}	Reverse Current	$V_R=200\text{V}$	-	5	15	μA
		$V_R=200\text{V}, T_c=150^\circ\text{C}$	-	-	4	mA
t_{rr}	Reverse Recovery Time	$I_F=20\text{A}, dI_F/dt=100\text{A}/\mu\text{s}$	-	-	30	ns
$R_{th(J-C)}$	Thermal Resistance		-	-	1.5	°C/W

Typical Performance Curves

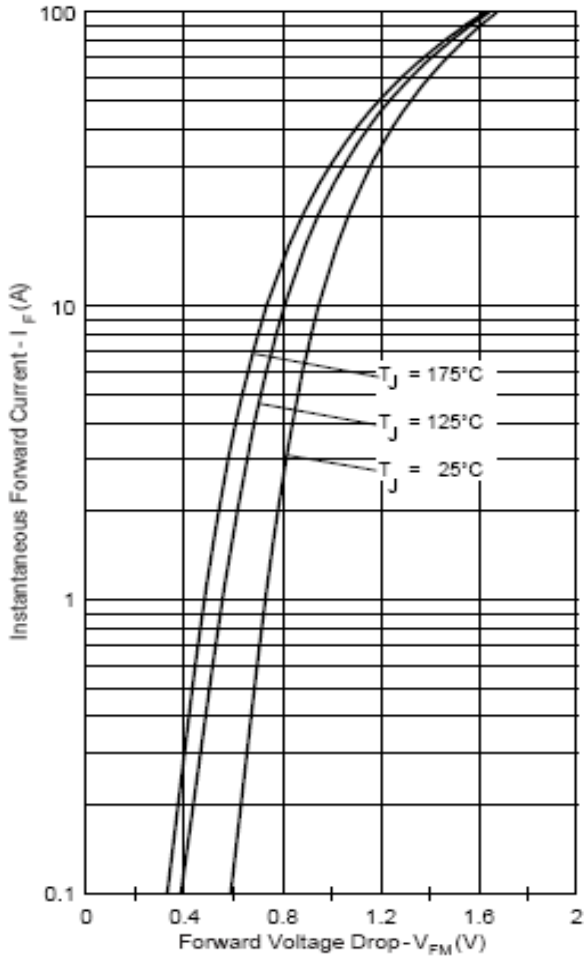

Fig.1 Forward Characteristics

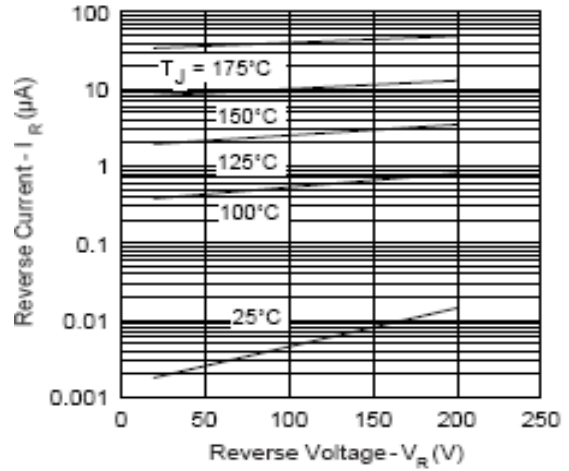

Fig.2 Reverse Characteristics

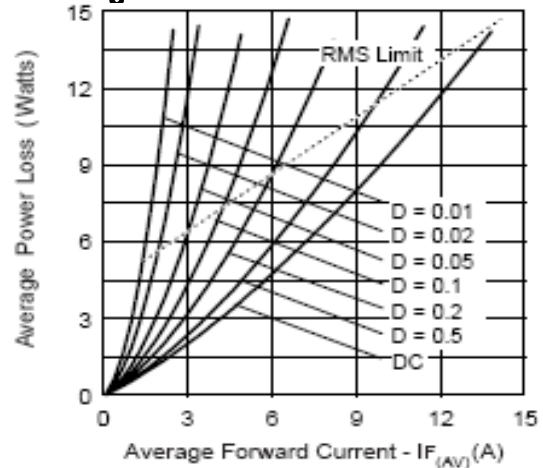

Fig.3 Forward Power Dissipation

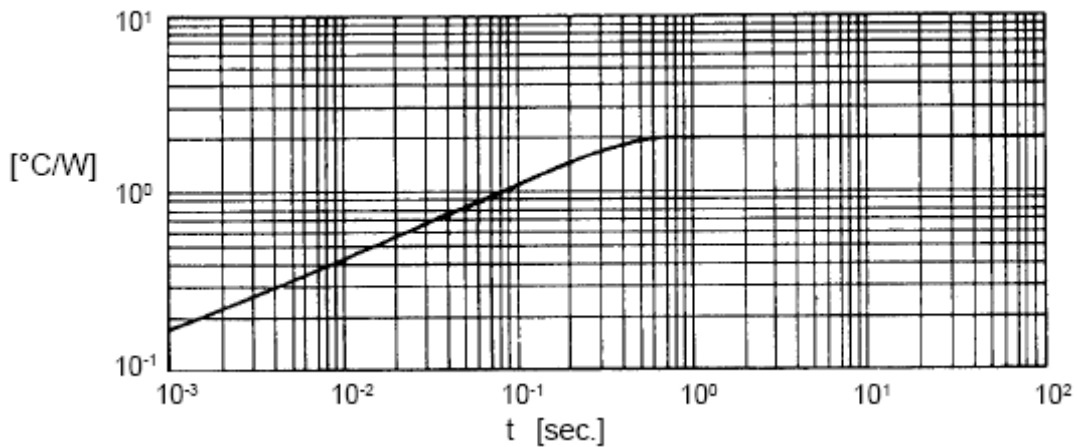

Fig.4 Transient Thermal Impedance

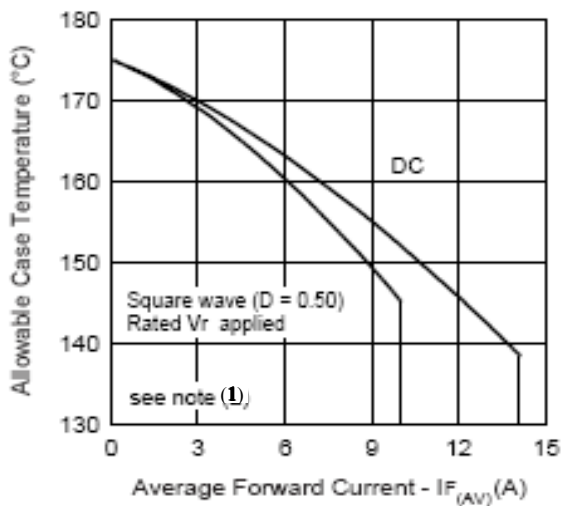

Fig.5 Case Temperature vs Out Current

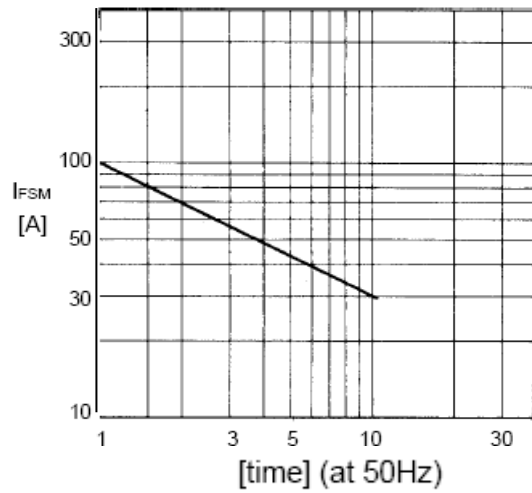

Fig.6 Surge Capability

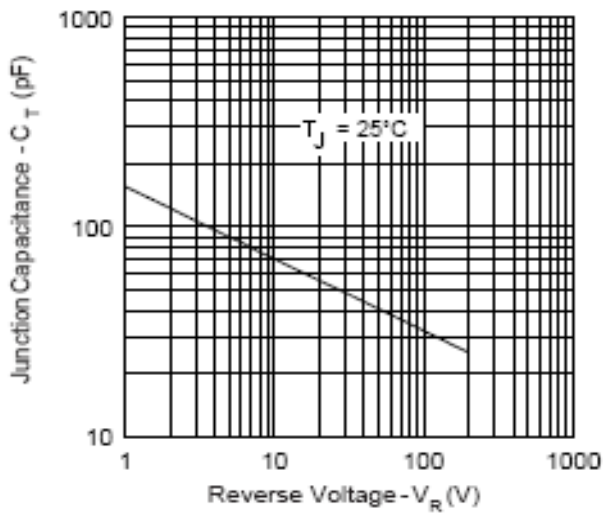

Fig.7 Junction Capacitance Characteristics

(1) Formula used: $T_C = T_J - (P_d + P_{d_{REV}}) \times R_{thJC}$

P_d = Forward Power Loss = $I_{F(AV)} \times V_{FM} @ (I_{F(AV)} / D)$ (see Fig.3)

$P_{d_{REV}}$ = Inverse Power Loss = $V_{R1} \times I_R (1 - D)$; $I_R @ V_{R1}$ = rated V_R

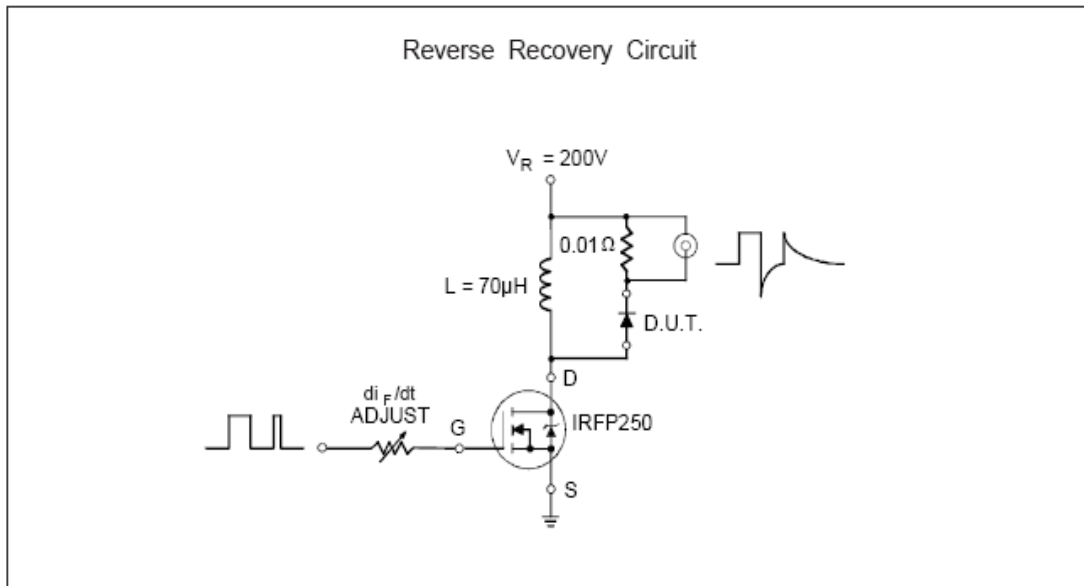

Fig.8 Reverse Recovery Parameter Test Circuit

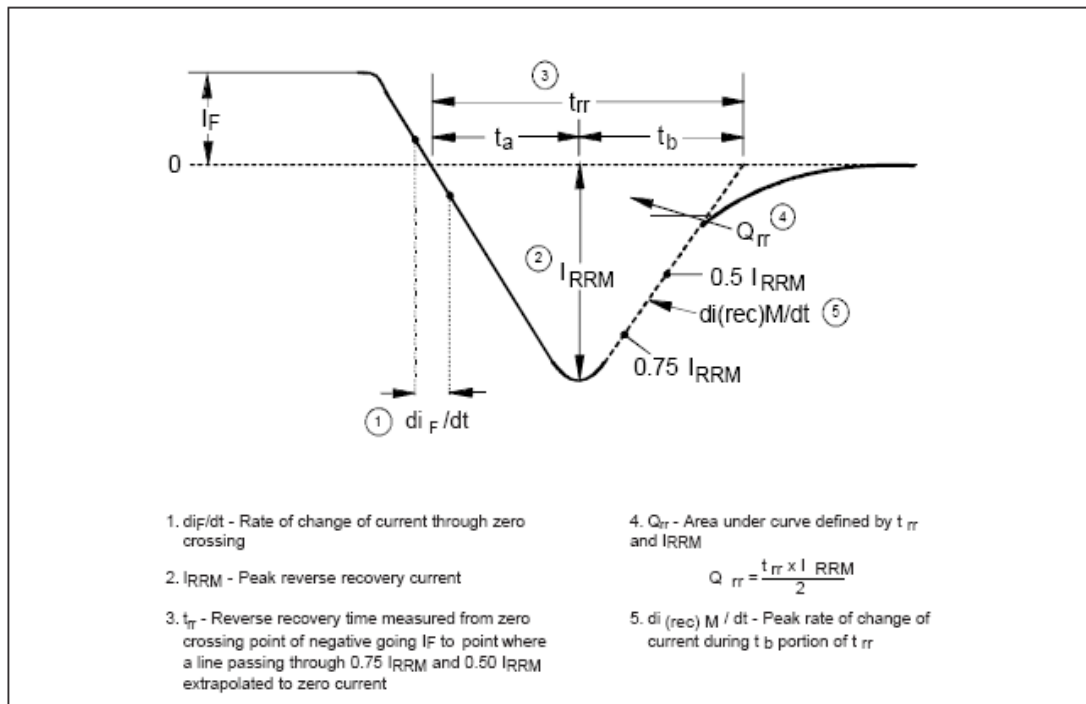

Fig.9 Reverse Recovery Waveform and Definitions

TO-3P Package Dimension

