

Power SMD LED PLCC-4

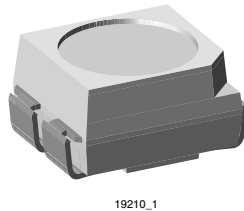

FEATURES

- 3 anode pins, 1 cathode pin
- High efficient InGaN technology
- Long life time, due to silicone casting
- Angle of half intensity $\varphi = \pm 60^\circ$
- Available in 8 mm tape
- Luminous intensity and color categorized per packing unit
- Luminous intensity ratio per packing unit $I_{Vmax}/I_{Vmin.} \leq 1.6$
- ESD-withstand voltage: up to 2 kV (HBM) according to JESD22-A114-B
- Preconditioning: according to JEDEC level 2a
- Compatible with IR-reflow, vapor phase and wave soldering processes according to CECC 00802 and J-STD-020
- AEC-Q101 qualified
- Compliant to RoHS directive 2002/95/EC and in accordance to WEEE 2002/96/EC

RoHS
COMPLIANT

DESCRIPTION

The VLMW321.. white LED is an advanced product in terms of heat dissipation.

The leadframe profile of this PLCC-4 SMD package is optimized to reduce the thermal resistance.

This allows higher drive current and doubles the light output compared to Vishay's high intensity SMD LED in PLCC-2 standard package.

PRODUCT GROUP AND PACKAGE DATA

- Product group: LED
- Package: PLCC-4
- Product series: SMD power
- Angle of half intensity: $\pm 60^\circ$

APPLICATIONS

- Camera flash light
- Signals, signs and symbol luminaire
- Marker lights
- Interior and exterior automotive lighting (brake lights, turn lights, backlighting, side markers)
- Indicator lighting
- General and architectural lighting
- Backlighting (advertising, displays, LCDs, switches, ...)

PARTS TABLE

PART	COLOR, LUMINOUS INTENSITY	TECHNOLOGY WAVELENGTH
VLMW321ABBB5K8L-08	White, $I_V = (1400 \text{ to } 2850) \text{ mcd}$	InGaN on SiC
VLMW321BACA5K8L-08	White, $I_V = (1800 \text{ to } 3550) \text{ mcd}$	InGaN on SiC

ABSOLUTE MAXIMUM RATINGS ¹⁾ VLMW321..

PARAMETER	TEST CONDITION	SYMBOL	VALUE	UNIT
Reverse voltage ²⁾		V_R	5	V
DC Forward current	$T_{amb} \leq 60\text{ }^\circ\text{C}$	I_F	50	mA
Surge forward current	$t_p \leq 10\text{ }\mu\text{s}$	I_{FSM}	0.3	A
Power dissipation		PV	200	mW
Junction temperature		T_j	125	$^\circ\text{C}$
Operating temperature range		T_{amb}	- 40 to + 110	$^\circ\text{C}$
Storage temperature range		T_{stg}	- 40 to + 110	$^\circ\text{C}$
Thermal resistance junction/ ambient	Mounted on PC board (pad design see page 6)	R_{thJA}	300	K/W

Note:

¹⁾ $T_{amb} = 25\text{ }^\circ\text{C}$, unless otherwise specified²⁾ Driving the LED in reverse direction is suitable for a short term application**OPTICAL AND ELECTRICAL CHARACTERISTICS ¹⁾ VLMW321.., WHITE**

PARAMETER	TEST CONDITION	PART	SYMBOL	MIN.	TYP.	MAX.	UNIT
Luminous intensity	$I_F = 30\text{ mA}$	VLMW321ABBB5K8L	I_V	1400	2200	2850	mcd
		VLMW321BACA5K8L	I_V	1800	2800	3550	mcd
Luminous Flux	$I_F = 30\text{ mA}$	VLMW321ABBB5K8L	ϕ_V		7000		mlm
		VLMW321BACA5K8L	ϕ_V		8900		mlm
Chromaticity coordinate x, y acc. to CIE 1931	$I_F = 30\text{ mA}$		x		0.33		
			y		0.33		
Angle of half intensity	$I_F = 30\text{ mA}$		φ		± 60		deg
Forward voltage	$I_F = 30\text{ mA}$		V_F	2.9	3.4	4	V
Reverse voltage	$I_R = 10\text{ }\mu\text{A}$		V_R	5			V
Temperature coefficient of V_F	$I_F = 30\text{ mA}$		TC_{VF}		- 3.6		mV/K
Temperature coefficient of I_V	$I_F = 30\text{ mA}$		TC_{IV}		- 0.5		%/K
Temperature coefficient of x	$I_F = 30\text{ mA}$		TC_x		- 0.0002		$\Delta x/K$
Temperature coefficient of y	$I_F = 30\text{ mA}$		TC_y		- 0.0003		$\Delta y/K$

Note:

¹⁾ $T_{amb} = 25\text{ }^\circ\text{C}$, unless otherwise specified**LUMINOUS INTENSITY CLASSIFICATION**

GROUP	LIGHT INTENSITY (mcd)	
	MIN.	MAX.
AB	1400	1800
BA	1800	2240
BB	2240	2850
CA	2850	3550

Note:

Luminous intensity is tested at a current pulse duration of 25 ms and an accuracy of $\pm 11\%$.

The above type numbers represent the order groups which include only a few brightness groups. Only one group will be shipped on each reel (there will be no mixing of two groups on each reel).

In order to ensure availability, single brightness groups will not be orderable.

In a similar manner for colors where wavelength groups are measured and binned, single wavelength groups will be shipped on any one reel.

In order to ensure availability, single wavelength groups will not be orderable.

CHROMATICITY COORDINATED GROUPS FOR WHITE SMD LED						
	X	Y		X	Y	
5L	0.291	0.268		7L	0.330	0.330
	0.285	0.279			0.330	0.347
	0.307	0.312			0.347	0.371
	0.310	0.297			0.345	0.352
5K	0.296	0.259		7K	0.330	0.310
	0.291	0.268			0.330	0.330
	0.310	0.297			0.338	0.342
	0.313	0.284			0.352	0.344
6L	0.310	0.297		8L	0.345	0.352
	0.307	0.312			0.347	0.371
	0.330	0.347			0.367	0.401
	0.330	0.330			0.364	0.380
6K	0.313	0.284		8K	0.352	0.344
	0.310	0.297			0.338	0.342
	0.330	0.330			0.364	0.380
	0.330	0.310			0.360	0.357

Note:

Chromaticity coordinate groups are tested at a current pulse duration of 25 ms and a tolerance of ± 0.01 .

TYPICAL CHARACTERISTICS

$T_{amb} = 25\text{ }^{\circ}\text{C}$, unless otherwise specified

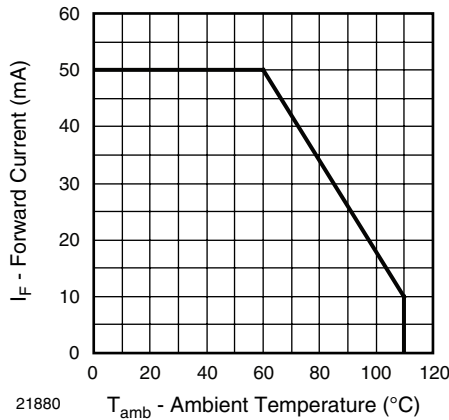

Figure 1. Forward Current vs. Ambient Temperature

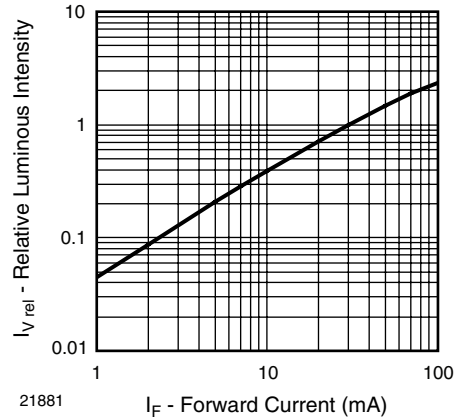

Figure 2. Relative Luminous Intensity vs. Forward Current

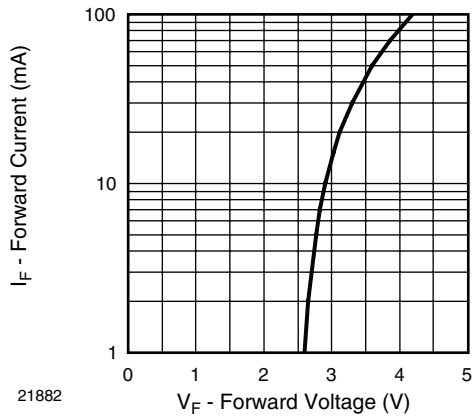

Figure 3. Forward Current vs. Forward Voltage

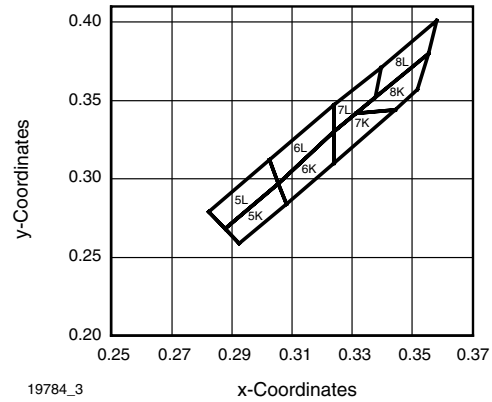

Figure 6. White Grouping SMD

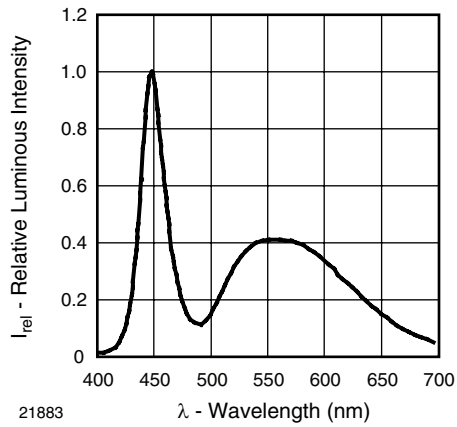

Figure 4. Relative Intensity vs. Wavelength

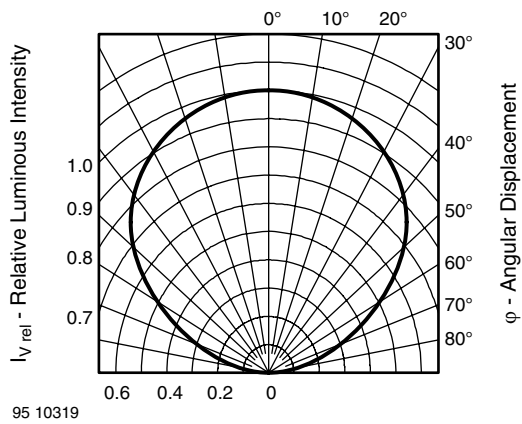
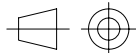
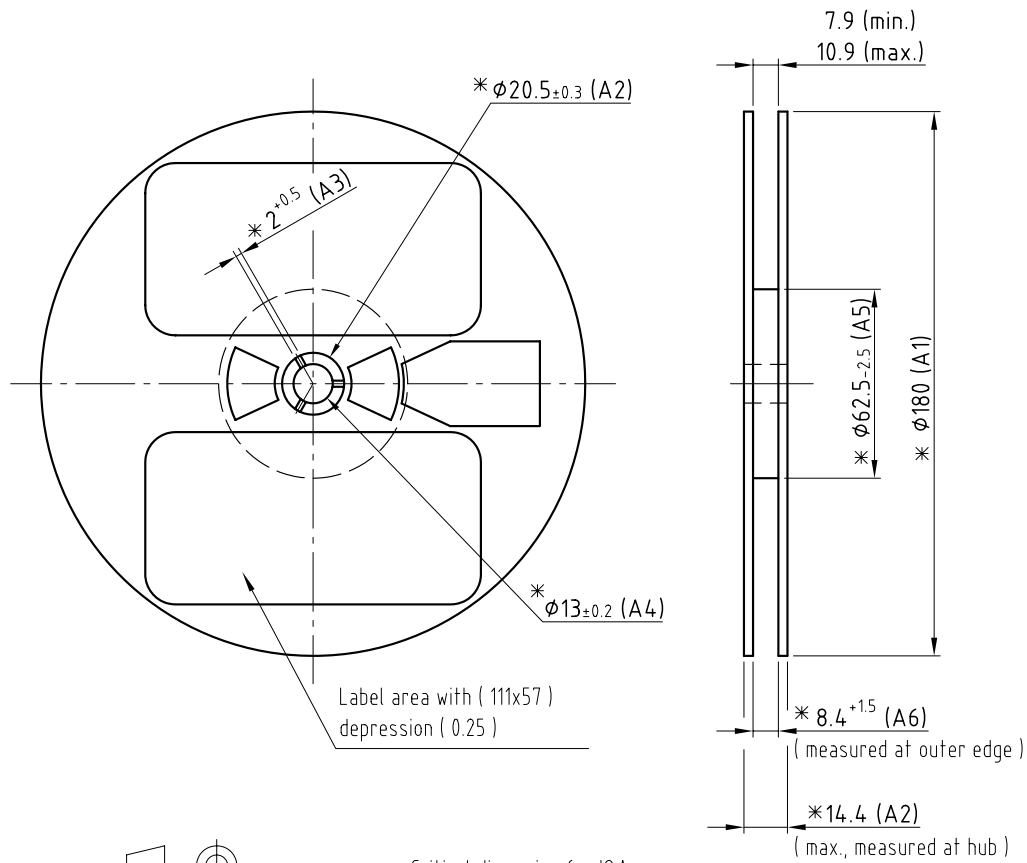

Figure 5. Rel. Luminous Intensity vs. Angular Displacement

REEL DIMENSIONS in millimeters

 technical drawings
 according to DIN
 specifications

* Critical dimension for IQA.

GS08 = 2000 pcs

 Not indicated tolerances ± 0.05
 Material: black static dissipative

 Drawing refers to following types: $\phi 180$ mm Plastic reel

Drawing-No.: 9.800-5086.01-4

Issue: 2; 05.05.08

20983

TAPING DIMENSIONS in millimeters

Taping and orientation

180 reel come in quantity of 2000 units

330 reel come in quantity of 8000 units

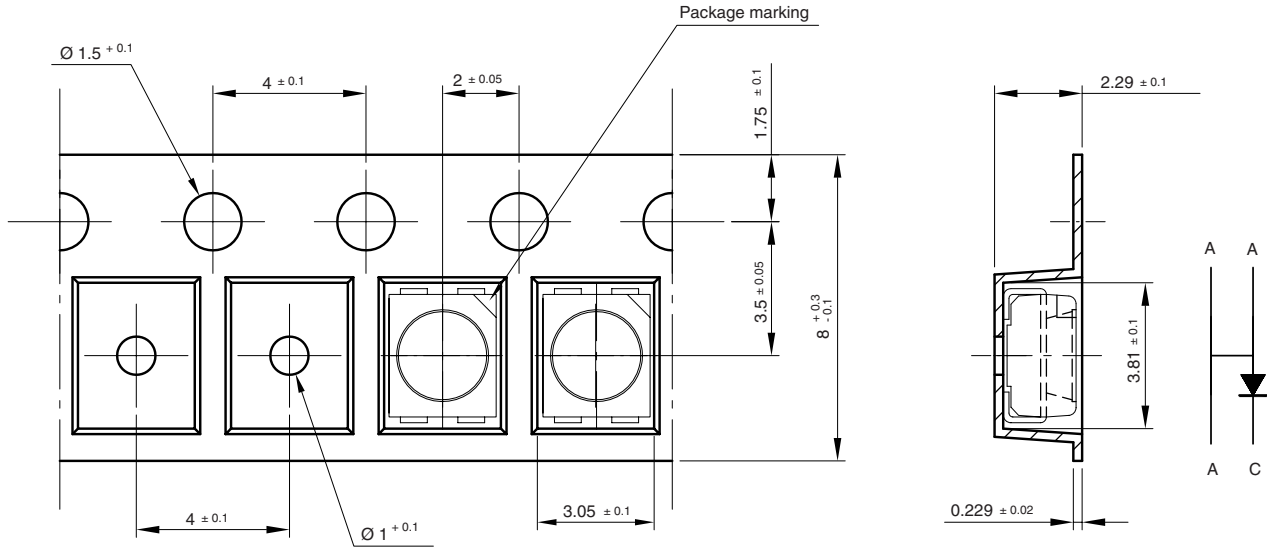

200 mm min. for 180 reel
200 mm min. for 330 reel

480 mm min. for 180 reel
960 mm min. for 330 reel

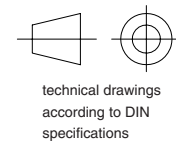
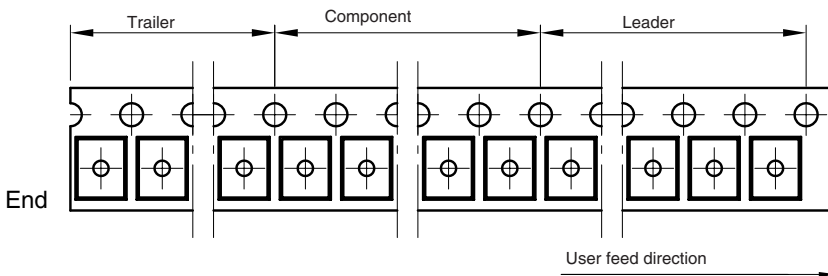

Drawing-No.: 9.700-5334.01-4

Issue: 3; 27.11.08

21066

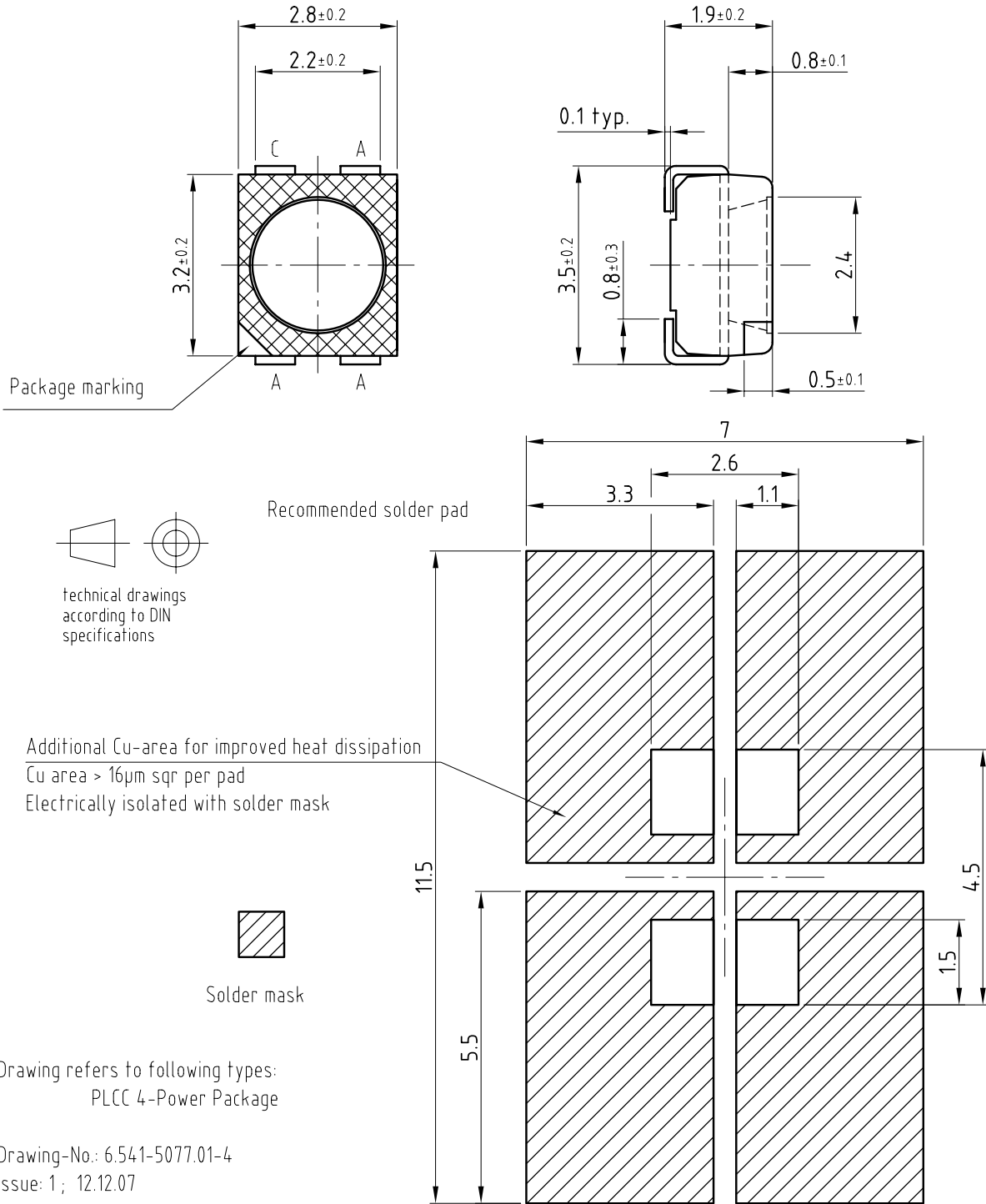
OPTIONAL PAD DESIGN DIMENSIONS in millimeters
 (Reflow-Soldering), $R_{thJA} = 290$ K/W

SOLDERING PROFILE

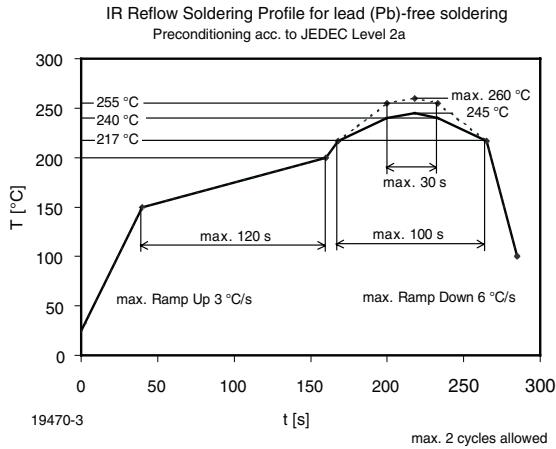

Figure 7. Vishay Lead (Pb)-free Reflow Soldering Profile (acc. to J-STD-020)

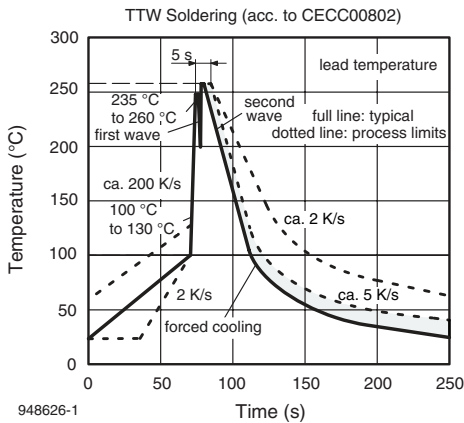
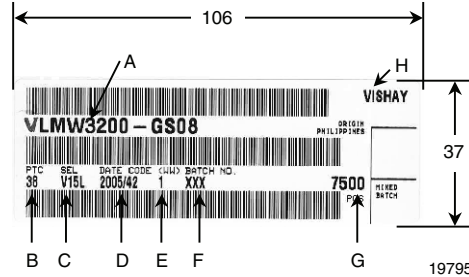

Figure 8. Double Wave Soldering of Opto Devices (all Packages)

BARCODE-PRODUCT-LABEL EXAMPLE:



- A) Type of component
- B) Manufacturing plant
- C) SEL - selection code (bin):
e.g.: V1 = code for luminous intensity group
5L = code for chrom. coordinate group
- D) Date code year/week
- E) Day code (e. g. 1: Monday)
- F) Batch no.
- G) Total quantity
- H) Company code

DRY PACKING

The reel is packed in an anti-humidity bag to protect the devices from absorbing moisture during transportation and storage.

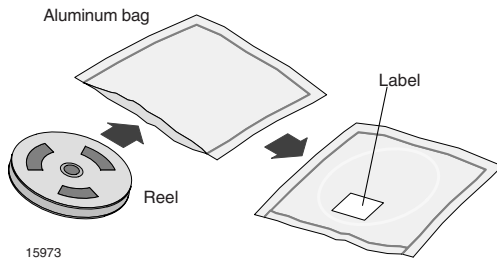

FINAL PACKING

The sealed reel is packed into a cardboard box. A secondary cardboard box is used for shipping purposes.

RECOMMENDED METHOD OF STORAGE

Dry box storage is recommended as soon as the aluminum bag has been opened to prevent moisture absorption. The following conditions should be observed, if dry boxes are not available:

- Storage temperature 10 °C to 30 °C
- Storage humidity $\leq 60\%$ RH max.

After more than 672 h under these conditions moisture content will be too high for reflow soldering.

In case of moisture absorption, the devices will recover to the former condition by drying under the following condition:

192 h at 40 °C + 5 °C/- 0 °C and < 5 % RH (dry air/nitrogen) or

96 h at 60 °C + 5 °C and < 5 % RH for all device containers or

24 h at 100 °C + 5 °C not suitable for reel or tubes.

An EIA JEDEC standard JESD22-A112 level 2a label is included on all dry bags.

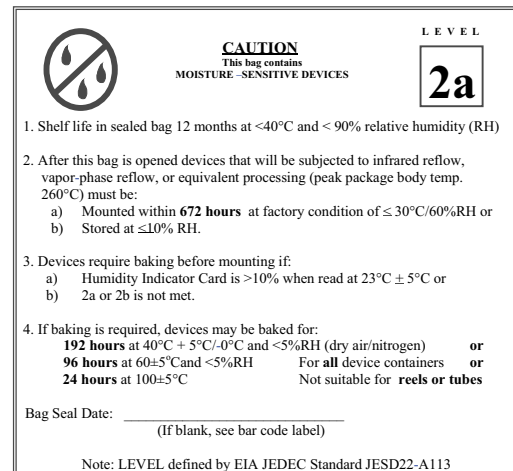

Example of JESD22-A112 Level 2a label

ESD PRECAUTION

Proper storage and handling procedures should be followed to prevent ESD damage to the devices especially when they are removed from the antistatic shielding bag. Electro-static sensitive devices warning labels are on the packaging.



Disclaimer

All product specifications and data are subject to change without notice.

Vishay Intertechnology, Inc., its affiliates, agents, and employees, and all persons acting on its or their behalf (collectively, "Vishay"), disclaim any and all liability for any errors, inaccuracies or incompleteness contained herein or in any other disclosure relating to any product.

Vishay disclaims any and all liability arising out of the use or application of any product described herein or of any information provided herein to the maximum extent permitted by law. The product specifications do not expand or otherwise modify Vishay's terms and conditions of purchase, including but not limited to the warranty expressed therein, which apply to these products.

No license, express or implied, by estoppel or otherwise, to any intellectual property rights is granted by this document or by any conduct of Vishay.

The products shown herein are not designed for use in medical, life-saving, or life-sustaining applications unless otherwise expressly indicated. Customers using or selling Vishay products not expressly indicated for use in such applications do so entirely at their own risk and agree to fully indemnify Vishay for any damages arising or resulting from such use or sale. Please contact authorized Vishay personnel to obtain written terms and conditions regarding products designed for such applications.

Product names and markings noted herein may be trademarks of their respective owners.