



# Low IBIAS, +1.4V/800nA, Rail-to-Rail Op Amps with +1.2V Buffered Reference

**MAX4036-MAX4039**

## General Description

The single MAX4036/MAX4037 and dual MAX4038/MAX4039 operational amplifiers operate from a single +1.4V to +3.6V (without reference) or +1.8V to +3.6V (with reference) supply and consume only 800nA of supply current per amplifier, and 1.1μA for the optional reference. The MAX4036/MAX4038 feature a common-mode input voltage range from 0V to  $V_{DD} - 0.4V$  at  $V_{DD} = 1.4V$ . The MAX4037/MAX4039 feature a 1.232V voltage reference capable of sourcing 100μA and sinking 20μA.

The MAX4036-MAX4039s' rail-to-rail outputs drive 5kΩ loads to within 25mV of the rails. Ultra-low supply current, low operating voltage, and rail-to-rail outputs make the MAX4036-MAX4039 ideal for use in single-cell lithium-ion (Li+), or two-cell NiCd/NiMH/alkaline battery-powered applications.

The MAX4036 is available in an SC70 package, the MAX4037 in a SOT23 package, and the MAX4038/MAX4039 in UCSP™, μMAX®, and TDFN packages. All devices are specified over the -40°C to +85°C extended temperature range.

## Applications

Battery-Powered/Solar-Powered Systems  
 Portable Medical Instrumentation  
 Pagers and Cell Phones  
 Micropower Thermostats and Potentiostats  
 Electrometer Amplifiers  
 Remote Sensor Amplifiers  
 Active Badges  
 pH Meters

μMAX is a registered trademark and UCSP is a trademark of Maxim Integrated Products, Inc.

## Functional Diagram

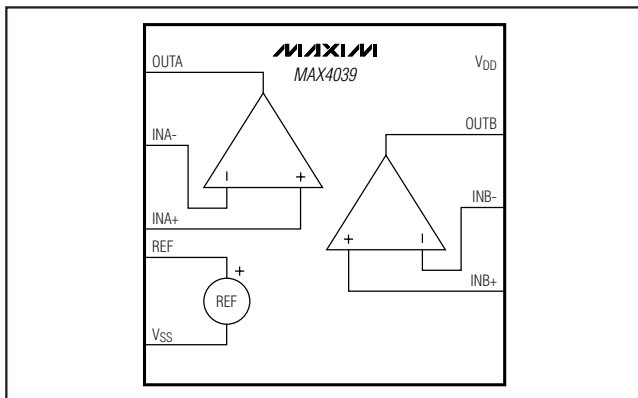

## Features

- ◆ Ultra-Low 800nA per Amplifier Supply Current
- ◆ Ultra-Low 1.4V Supply Voltage Operation (1.8V for MAX4037/MAX4039)
- ◆ Rail-to-Rail Outputs Drive 5kΩ and 5000pF Load
- ◆ 1.232V ±0.5%, 120ppm/°C (max) Reference (MAX4037/MAX4039)
- ◆ No External Reference Bypass Capacitor Required
- ◆ No Phase Reversal for Overdriven Inputs
- ◆ Low 1.0pA (typ) Input Bias Current
- ◆ Low 200μV Input Offset Voltage
- ◆ Unity-Gain Stable
- ◆ Available in Tiny UCSP, SC70, SOT23, TDFN, and μMAX Packages

## Ordering Information

PART	TEMP RANGE	PIN-PACKAGE	TOP MARK
MAX4036EXK-T	-40°C to +85°C	5 SC70-5	AFR
MAX4037EUT-T	-40°C to +85°C	6 SOT23-6	ABRX
MAX4038ETA	-40°C to +85°C	8 TDFN-EP*	AGO
MAX4038EUA	-40°C to +85°C	8 μMAX	—
MAX4038EBL-T	-40°C to +85°C	9 UCSP-9	AEG
MAX4039EBL-T	-40°C to +85°C	9 UCSP-9	AEH
MAX4039ETB	-40°C to +85°C	10 TDFN-EP*	AAN
MAX4039EUB	-40°C to +85°C	10 μMAX	—

\*EP = Exposed paddle.

Pin Configurations and Selector Guide appear at end of data sheet.

## Typical Operating Circuit

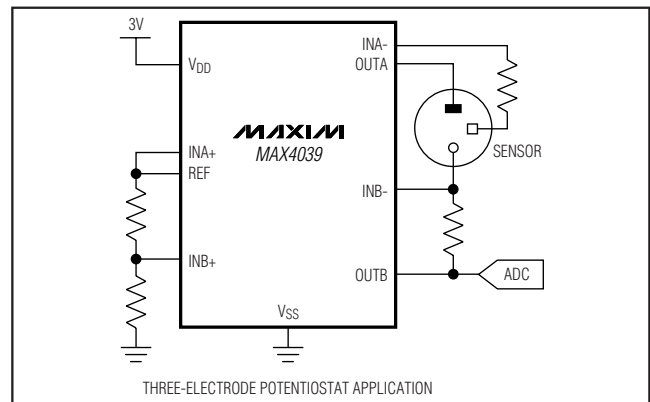

# Low IBIAS, +1.4V/800nA, Rail-to-Rail Op Amps with +1.2V Buffered Reference

## ABSOLUTE MAXIMUM RATINGS

V <sub>DD</sub> to V <sub>SS</sub> .....	-0.3V to +4.0V	8-Pin TDFN (derate 24.4mW/°C above +70°C) .....	1951mW
INA+, INB+, INA-, INB-, IN+, IN-, OUTA, OUTB, OUT, REF .....	(V <sub>SS</sub> - 0.3V) to (V <sub>DD</sub> + 0.3V)	9-Bump UCSP (derate 5.2mW/°C above +70°C).....	412mW
OUTA, OUTB, OUT, REF Shorted to V <sub>SS</sub> or V <sub>DD</sub> .....	Continuous	10-Pin μMAX (derate 5.6mW/°C above +70°C) .....	444mW
Maximum Continuous Power Dissipation (T <sub>A</sub> = +70°C)		10-Pin TDFN (derate 24.4mW/°C above +70°C) .....	1951mW
5-Pin SC70 (derate 3.1mW/°C above +70°C).....	247mW	Operating Temperature Range .....	-40°C to +85°C
6-Pin SOT23 (derate 8.7mW/°C above +70°C).....	696mW	Junction Temperature .....	+150°C
8-Pin μMAX (derate 4.5mW/°C above +70°C).....	362mW	Storage Temperature Range .....	-65°C to +150°C
		Lead Temperature (soldering, 10s).....	+300°C

Stresses beyond those listed under "Absolute Maximum Ratings" may cause permanent damage to the device. These are stress ratings only, and functional operation of the device at these or any other conditions beyond those indicated in the operational sections of the specifications is not implied. Exposure to absolute maximum rating conditions for extended periods may affect device reliability.

## ELECTRICAL CHARACTERISTICS

(V<sub>DD</sub> = +3V, V<sub>SS</sub> = V<sub>CM</sub> = 0V, V<sub>OUT</sub> = V<sub>DD</sub>/2, R<sub>L</sub> to V<sub>DD</sub>/2, C<sub>L</sub> = 15pF, T<sub>A</sub> = +25°C, unless otherwise specified.)

PARAMETER	SYMBOL	CONDITIONS	MIN	TYP	MAX	UNITS
Supply Voltage Range	V <sub>DD</sub>	MAX4036/MAX4038, guaranteed by PSRR tests	1.4		3.6	V
		MAX4037/MAX4039, guaranteed by PSRR and line regulation tests	1.8		3.6	
Supply Current	I <sub>DD</sub>	MAX4036	V <sub>DD</sub> = 1.4V	0.8	1.2	μA
			V <sub>DD</sub> = 3.6V	0.9	1.3	
		MAX4037	V <sub>DD</sub> = 1.8V	1.9	2.4	
			V <sub>DD</sub> = 3.6V	2.0	2.5	
		MAX4038	V <sub>DD</sub> = 1.4V	1.7	2.3	
			V <sub>DD</sub> = 3.6V	1.9	2.5	
MAX4039	V <sub>DD</sub> = 1.8V	2.8	4.0			
	V <sub>DD</sub> = 3.6V	3.0	4.1			
<b>OPERATIONAL AMPLIFIERS</b>						
Input Offset Voltage	V <sub>OS</sub>			±0.2	±2.0	mV
Input Bias Current	I <sub>B</sub>	(Note 1)		±1.0	±10	pA
Input Offset Current	I <sub>OS</sub>	(Note 1)		±0.3	±20	pA
Input Common-Mode Voltage Range	V <sub>CM</sub>	Guaranteed by CMRR test	V <sub>DD</sub> = 1.4V (MAX4036/MAX4038 only)	V <sub>SS</sub>	V <sub>DD</sub> - 0.4	V
			V <sub>DD</sub> = 1.8V	V <sub>SS</sub>	V <sub>DD</sub> - 0.3	
			V <sub>DD</sub> = 3.3V	V <sub>SS</sub>	V <sub>DD</sub> - 0.2	
Common-Mode Rejection Ratio	CMRR	V <sub>DD</sub> = 1.4V, V <sub>SS</sub> ≤ V <sub>CM</sub> ≤ (V <sub>DD</sub> - 0.4V) (MAX4036/MAX4038 only)	50	70		dB
		V <sub>DD</sub> = 1.8V, V <sub>SS</sub> ≤ V <sub>CM</sub> ≤ (V <sub>DD</sub> - 0.3V)	50	70		
		V <sub>DD</sub> = 3.3V, V <sub>SS</sub> ≤ V <sub>CM</sub> ≤ (V <sub>DD</sub> - 0.2V)	56	76		
Power-Supply Rejection Ratio	PSRR	1.4V ≤ V <sub>DD</sub> ≤ 3.6V (MAX4036/MAX4038 only)	62	82		dB
		1.8V ≤ V <sub>DD</sub> ≤ 3.6V	62	84		

# Low IBIAS, +1.4V/800nA, Rail-to-Rail Op Amps with +1.2V Buffered Reference

MAX4036-MAX4039

## ELECTRICAL CHARACTERISTICS (continued)

( $V_{DD} = +3V$ ,  $V_{SS} = V_{CM} = 0V$ ,  $V_{OUT\_} = V_{DD}/2$ ,  $R_L$  to  $V_{DD}/2$ ,  $C_L = 15pF$ ,  $T_A = +25^\circ C$ , unless otherwise specified.)

PARAMETER	SYMBOL	CONDITIONS	MIN	TYP	MAX	UNITS
Large-Signal Voltage Gain	$A_{VOL}$	$R_L = 100k\Omega$ , $50mV \leq V_{OUT} \leq (V_{DD} - 50mV)$	80	108		dB
		$R_L = 5k\Omega$ , $150mV \leq V_{OUT} \leq (V_{DD} - 150mV)$	78	105		
Output Voltage Swing High	$V_{DD} - V_{OH}$	$R_L = 100k\Omega$		2	5	mV
		$R_L = 5k\Omega$		25	50	
Output Voltage Swing Low	$V_{OL} - V_{SS}$	$R_L = 100k\Omega$		2	5	mV
		$R_L = 5k\Omega$		25	50	
Output Short-Circuit Current	$I_{SCO}$	To $V_{DD}$ or $V_{SS}$		$\pm 13$		mA
Gain-Bandwidth Product	GBW			4		kHz
Phase Margin	$\theta_M$			90		Degrees
Slew Rate	SR			0.4		V/ms
Power-On Time	$t_{ON}$	(Note 3)		0.25		ms
Input Noise-Voltage Density	$e_n$	$f = 1kHz$		500		$nV/\sqrt{Hz}$
Capacitive-Load Stability	$C_{LOAD}$	$A_{VCL} = 1V/V$ , no sustained oscillations		5000		pF
<b>REFERENCE (MAX4037/MAX4039)</b>						
Reference Voltage	$V_{REF}$		1.226	1.232	1.238	V
Line Regulation	$\Delta V_{REF}/\Delta V_{DD}$	$V_{DD} = +1.8V$ to $+3.6V$			0.3	%/V
Load Regulation	$\Delta V_{REF}/\Delta I_{LOAD}$	$0 \leq I_{LOAD} \leq 100\mu A$ , sourcing			0.0015	%/μA
		$-20\mu A \leq I_{LOAD} \leq 0$ , sinking			0.0075	
Reference Output Voltage Noise	$e_n$	0.1Hz to 10Hz		60		$\mu V_{P-P}$
Output Short-Circuit Current	$I_{SCR}$	Short to $V_{DD}$		0.25		mA
		Short to $V_{SS}$		1.9		
Capacitive-Load Stability Range	$C_{LOAD}$	(Note 1)	0		250	pF

## ELECTRICAL CHARACTERISTICS

( $V_{DD} = +3V$ ,  $V_{SS} = V_{CM} = 0V$ ,  $V_{OUT\_} = V_{DD}/2$ ,  $R_L$  to  $V_{DD}/2$ ,  $C_L = 15pF$ ,  $T_A = T_{MIN}$  to  $T_{MAX}$ , unless otherwise specified.) (Note 2)

PARAMETER	SYMBOL	CONDITIONS	MIN	TYP	MAX	UNITS
Supply Voltage Range	$V_{DD}$	MAX4036/MAX4038, guaranteed by PSRR test	1.4		3.6	V
		MAX4037/MAX4039, guaranteed by PSRR and line regulation tests	1.8		3.6	
Supply Current	$I_{DD}$	MAX4036	$V_{DD} = 1.4V$		1.7	μA
			$V_{DD} = 3.6V$		1.8	
		MAX4037	$V_{DD} = 1.8V$		3.1	
			$V_{DD} = 3.6V$		3.2	
		MAX4038	$V_{DD} = 1.4V$		2.9	
			$V_{DD} = 3.6V$		3.2	
		MAX4039	$V_{DD} = 1.8V$		5.2	
			$V_{DD} = 3.6V$		5.3	

# Low IBIAS, +1.4V/800nA, Rail-to-Rail Op Amps with +1.2V Buffered Reference

## ELECTRICAL CHARACTERISTICS (continued)

( $V_{DD} = +3V$ ,  $V_{SS} = V_{CM} = 0V$ ,  $V_{OUT\_} = V_{DD}/2$ ,  $R_L$  to  $V_{DD}/2$ ,  $C_L = 15pF$ ,  $T_A = T_{MIN}$  to  $T_{MAX}$ , unless otherwise specified.) (Note 2)

PARAMETER	SYMBOL	CONDITIONS		MIN	TYP	MAX	UNITS
<b>OPERATIONAL AMPLIFIERS</b>							
Input Offset Voltage	$V_{OS}$					$\pm 8$	mV
Input Offset Voltage Temperature Coefficient	$TCV_{OS}$				$\pm 1$		$\mu V/^\circ C$
Input Bias Current	$I_B$					$\pm 100$	pA
Input Offset Current	$I_{OS}$					$\pm 200$	pA
Input Common-Mode Voltage Range	$V_{CM}$	Guaranteed by CMRR test	$V_{DD} = 1.4V$ (MAX4036/MAX4038 only)	$V_{SS}$		$V_{DD} - 0.4$	V
			$V_{DD} = 1.8V$	$V_{SS}$		$V_{DD} - 0.4$	
			$V_{DD} = 3.3V$	$V_{SS}$		$V_{DD} - 0.2$	
Common-Mode Rejection Ratio	CMRR	$V_{DD} = 1.4V$ , $V_{SS} \leq V_{CM} \leq (V_{DD} - 0.4V)$ (MAX4036/MAX4038 only)		44			dB
		$V_{DD} = 1.8V$ , $V_{SS} \leq V_{CM} \leq (V_{DD} - 0.4V)$		50			
		$V_{DD} = 3.3V$ , $V_{SS} \leq V_{CM} \leq (V_{DD} - 0.2V)$		52			
Power-Supply Rejection Ratio	PSRR	$1.4V \leq V_{DD} \leq 3.6V$ (MAX4036/MAX4038 only)		60			dB
		$1.8V \leq V_{DD} \leq 3.6V$		60			
Large-Signal Voltage Gain	$A_{VOL}$	$R_L = 100k\Omega$ , $50mV \leq V_{OUT} \leq (V_{DD} - 50mV)$		75			dB
		$R_L = 5k\Omega$ , $150mV \leq V_{OUT} \leq (V_{DD} - 150mV)$		73			
Output Voltage Swing High	$V_{DD} - V_{OH}$	$R_L = 100k\Omega$				10	mV
		$R_L = 5k\Omega$				100	
Output Voltage Swing Low	$V_{OL} - V_{SS}$	$R_L = 100k\Omega$				10	mV
		$R_L = 5k\Omega$				100	
<b>REFERENCE (MAX4037/MAX4039)</b>							
Reference Voltage Temperature Coefficient	$TCV_{REF}$	(Note 1)	MAX4037EUT-T, MAX4039ETB, MAX4039EUB		25	120	ppm/ $^\circ C$
			MAX4039EBL-T		35	200	
Line Regulation	$\frac{\Delta V_{REF}}{\Delta V_{DD}}$	$V_{DD} = 1.8V$ to $3.6V$				0.6	%/V
Load Regulation	$\frac{\Delta V_{REF}}{\Delta I_{LOAD}}$	$0 \leq I_{LOAD} \leq 100\mu A$ , sourcing				0.003	%/ $\mu A$
		$-20\mu A \leq I_{LOAD} \leq 0$ , sinking				0.015	
Capacitive-Load Stability Range	$C_{LOAD}$	(Note 1)		0		250	pF

**Note 1:** Guaranteed by design.

**Note 2:** All devices are production tested at  $T_A = +25^\circ C$ . All temperature limits are guaranteed by design.

**Note 3:** Output settles within 1% of final value.

# Low IBIAS, +1.4V/800nA, Rail-to-Rail Op Amps with +1.2V Buffered Reference

## Typical Operating Characteristics

( $V_{DD} = 3V$ ,  $V_{SS} = V_{CM} = 0V$ ,  $R_L$  to  $V_{DD}/2$ ,  $T_A = +25^\circ C$ , unless otherwise noted.)

MAX4036-MAX4039

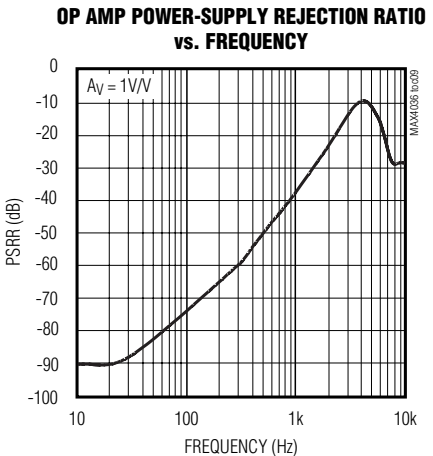
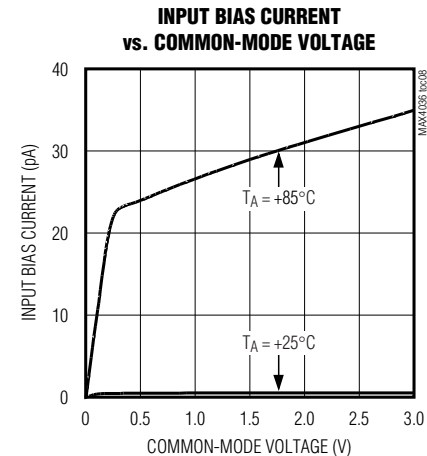
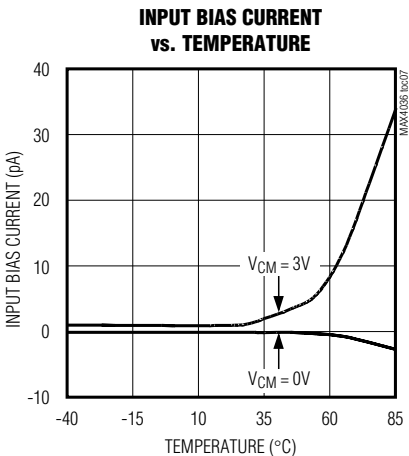
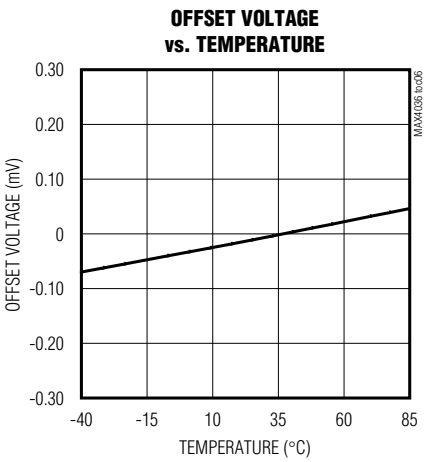
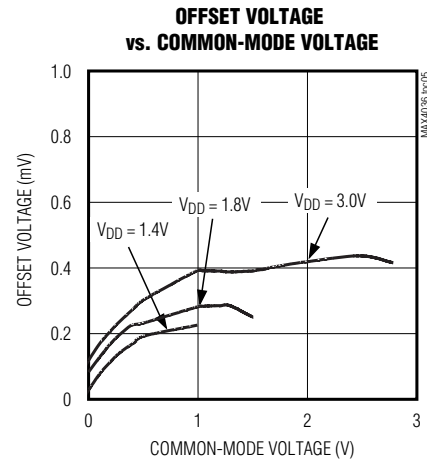
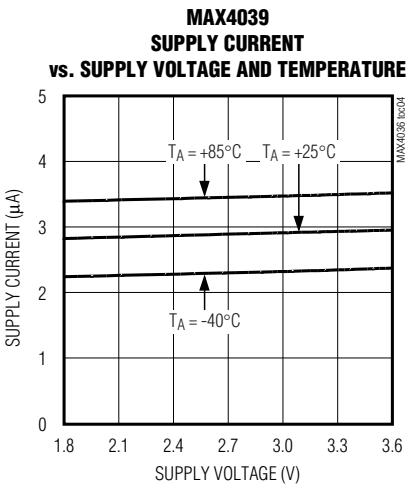
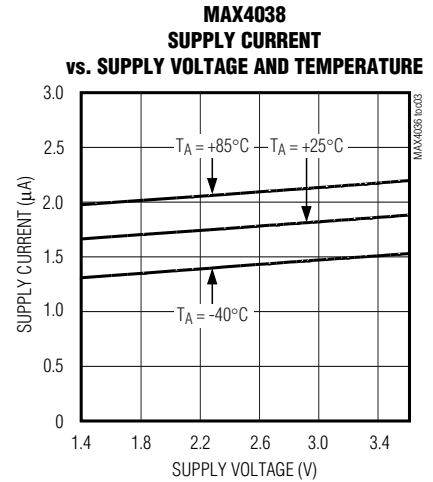
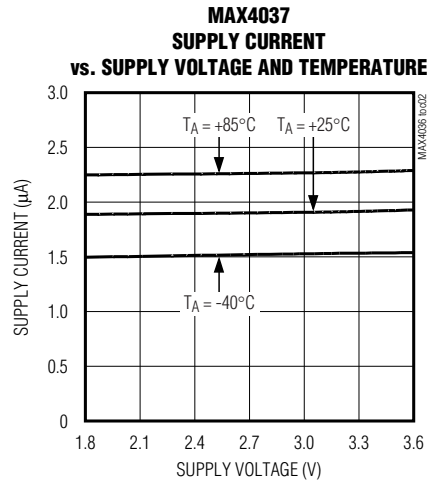
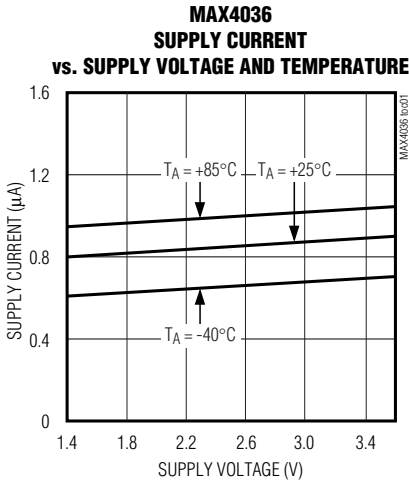

# Low IBIAS, +1.4V/800nA, Rail-to-Rail Op Amps with +1.2V Buffered Reference

## Typical Operating Characteristics (continued)

( $V_{DD} = 3V$ ,  $V_{SS} = V_{CM} = 0V$ ,  $R_L$  to  $V_{DD}/2$ ,  $T_A = +25^\circ C$ , unless otherwise noted.)

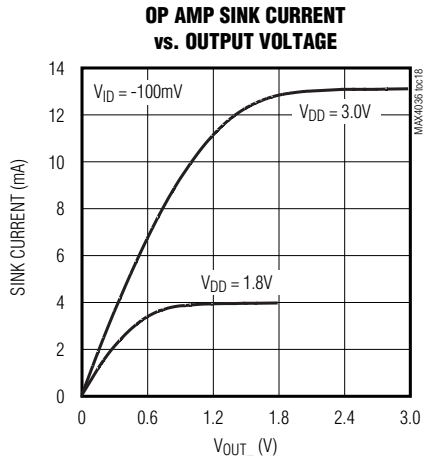
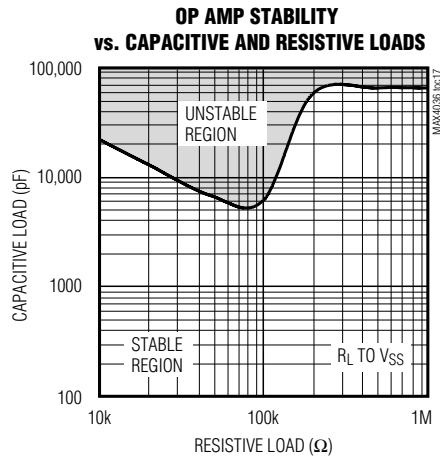
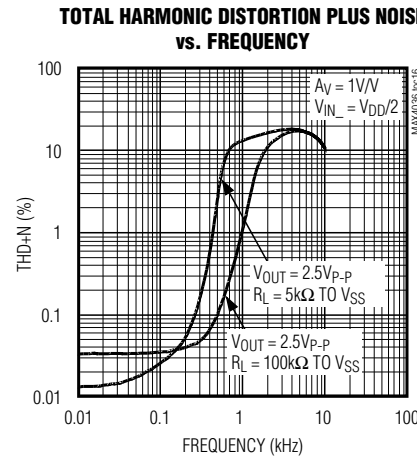
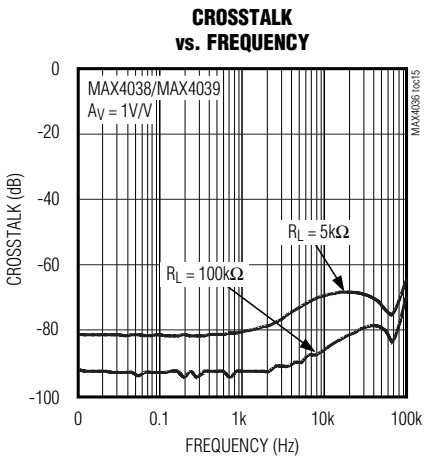
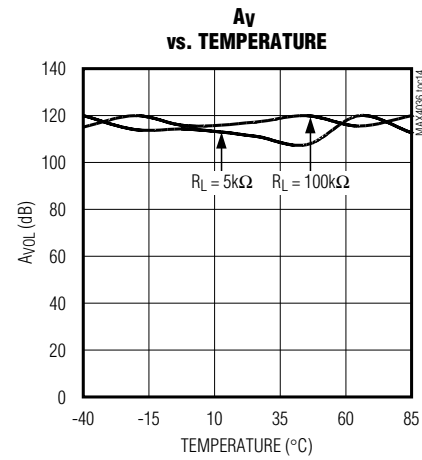
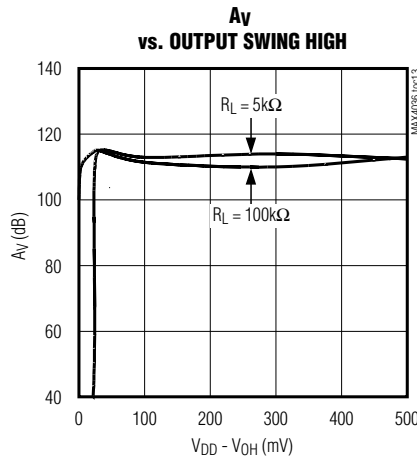
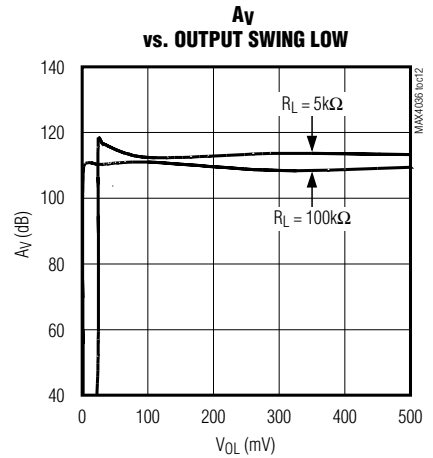
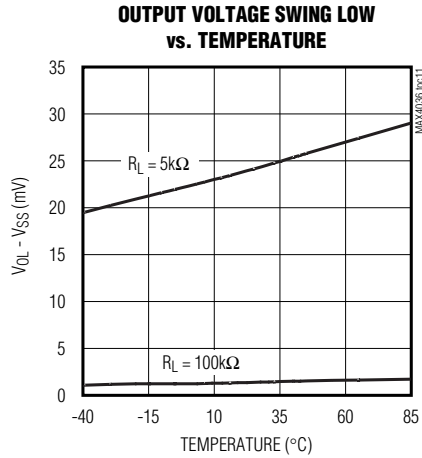
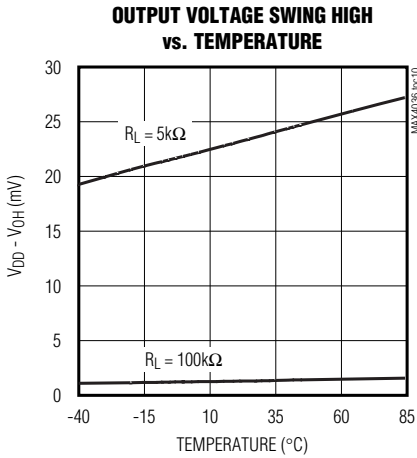

# Low IBIAS, +1.4V/800nA, Rail-to-Rail Op Amps with +1.2V Buffered Reference

MAX4036-MAX4039

## Typical Operating Characteristics (continued)

( $V_{DD} = 3V$ ,  $V_{SS} = V_{CM} = 0V$ ,  $R_L$  to  $V_{DD}/2$ ,  $T_A = +25^\circ C$ , unless otherwise noted.)

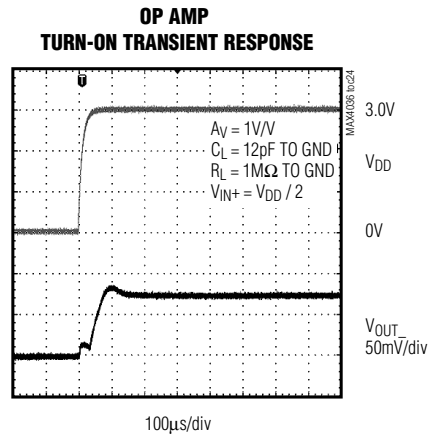
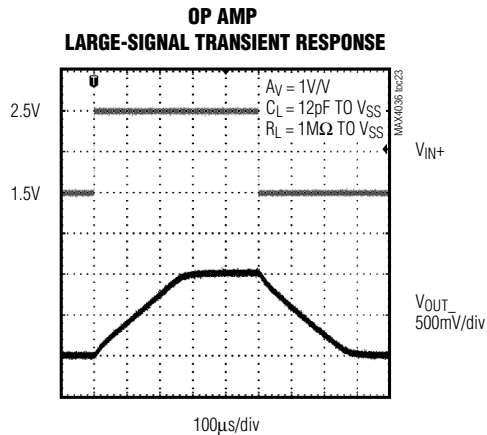
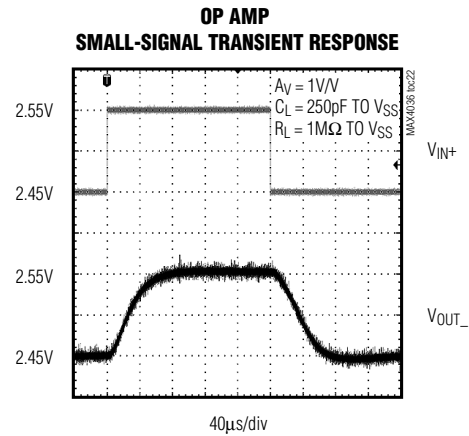
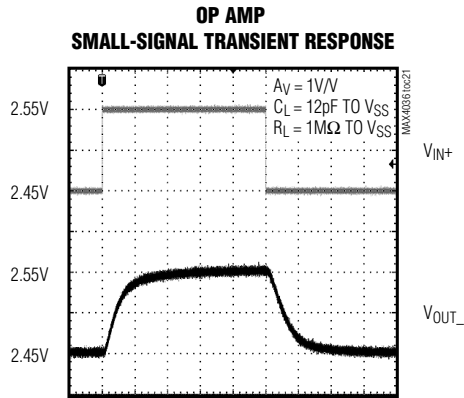
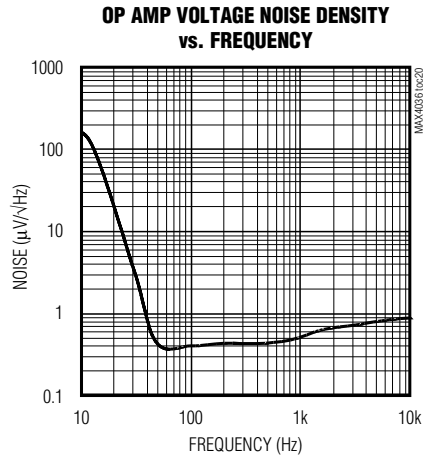
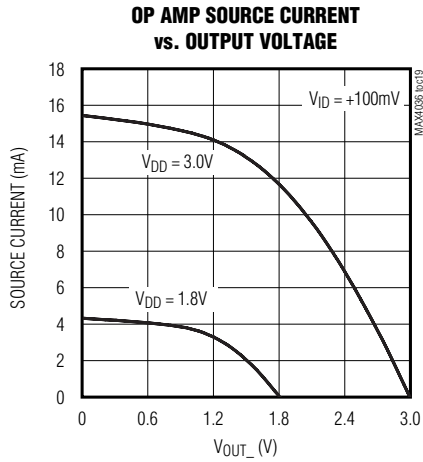

# Low IBIAS, +1.4V/800nA, Rail-to-Rail Op Amps with +1.2V Buffered Reference

## Typical Operating Characteristics (continued)

( $V_{DD} = 3V$ ,  $V_{SS} = V_{CM} = 0V$ ,  $R_L$  to  $V_{DD}/2$ ,  $T_A = +25^\circ C$ , unless otherwise noted.)

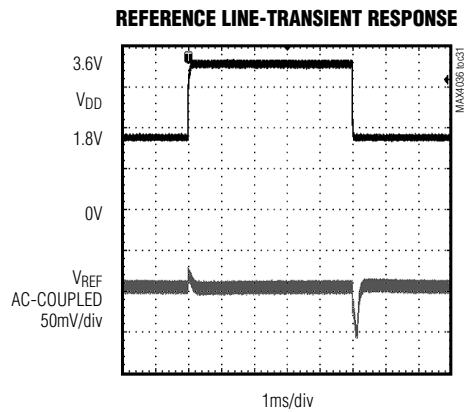
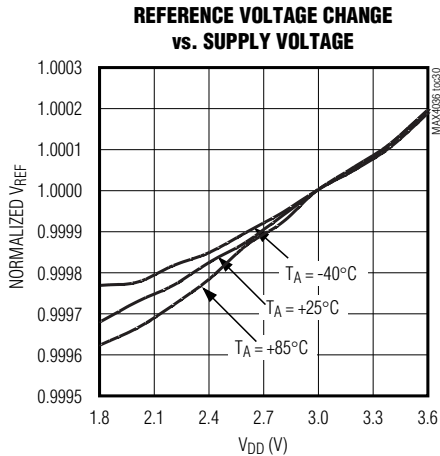
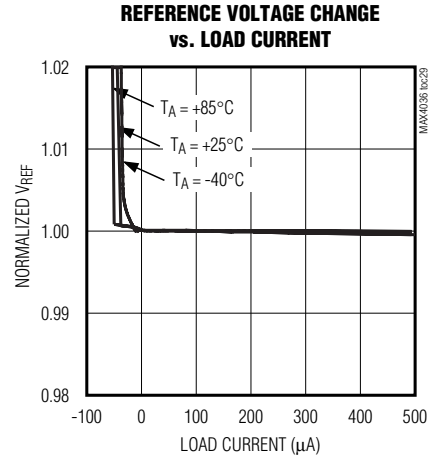
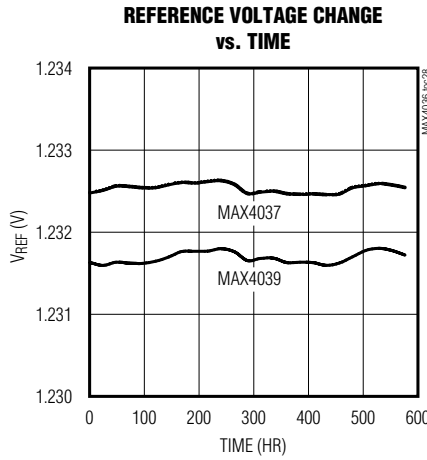
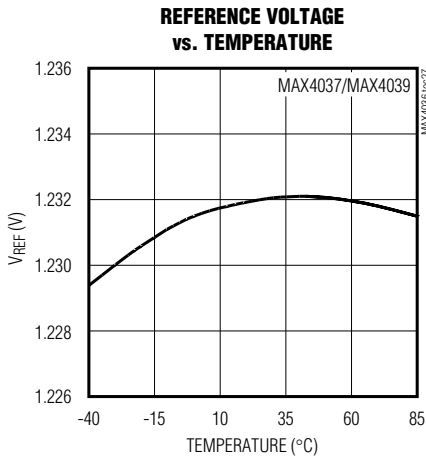
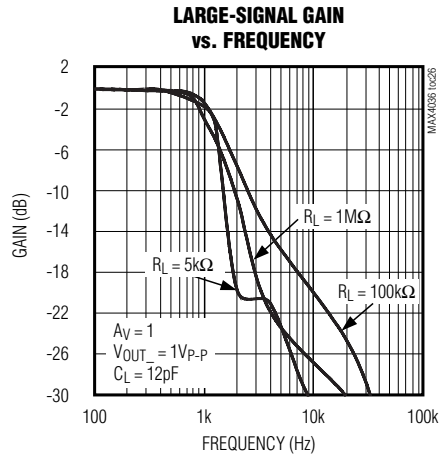
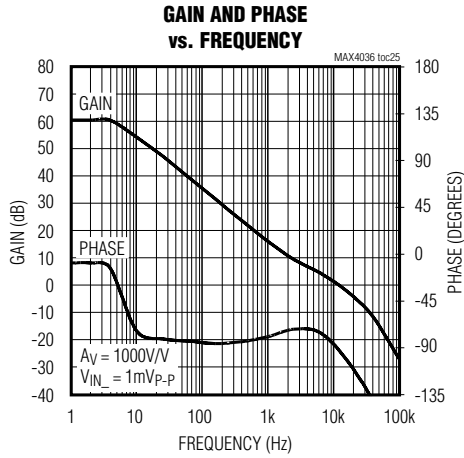



# Low IBIAS, +1.4V/800nA, Rail-to-Rail Op Amps with +1.2V Buffered Reference

## Typical Operating Characteristics (continued)

( $V_{DD} = 3V$ ,  $V_{SS} = V_{CM} = 0V$ ,  $R_L$  to  $V_{DD}/2$ ,  $T_A = +25^\circ C$ , unless otherwise noted.)

MAX4036-MAX4039

**REFERENCE LOAD-TRANSIENT RESPONSE (SINKING CURRENT)**

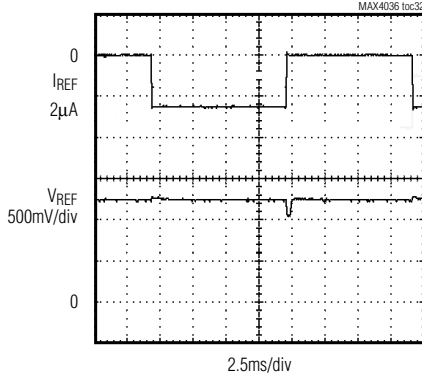

**REFERENCE LOAD-TRANSIENT RESPONSE (SINKING CURRENT)**

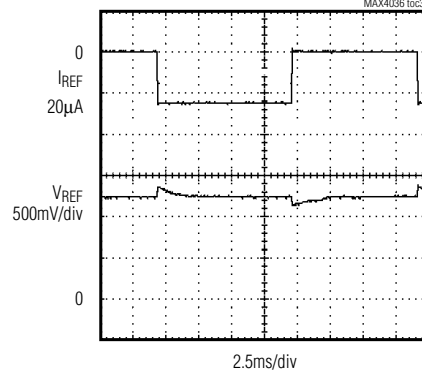

**REFERENCE LOAD-TRANSIENT RESPONSE (SOURCING CURRENT)**

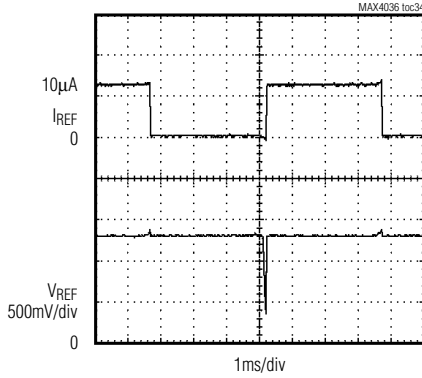

**REFERENCE LOAD-TRANSIENT RESPONSE (SOURCING CURRENT)**

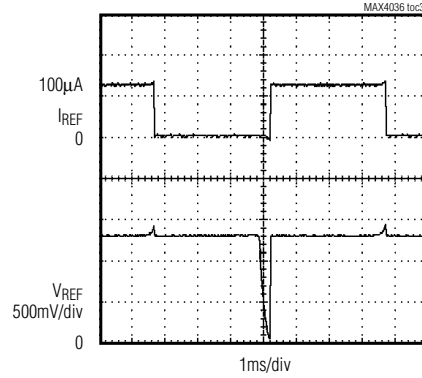

**REFERENCE TURN-ON TRANSIENT RESPONSE**

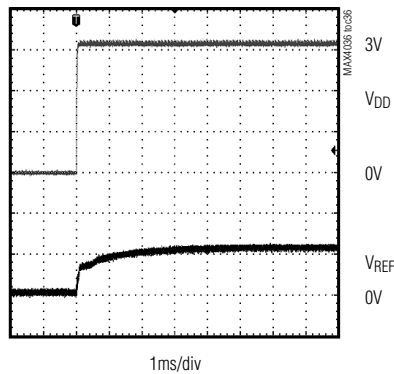

**0.1Hz TO 10Hz REFERENCE NOISE**

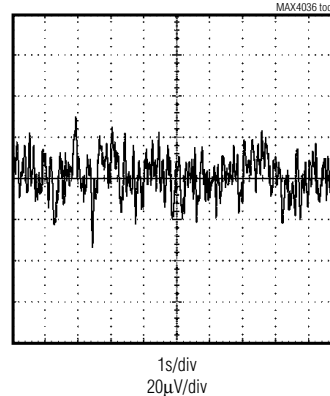

# Low IBIAS, +1.4V/800nA, Rail-to-Rail Op Amps with +1.2V Buffered Reference

## Pin Description

		PIN				NAME	FUNCTION
MAX4036	MAX4037	MAX4038		MAX4039			
		$\mu$ MAX/TDFN	UCSP	$\mu$ MAX/TDFN	UCSP		
1	3	—	—	—	—	IN+	Noninverting Amplifier Input
2	2	4	A2	5	A2	V <sub>SS</sub>	Negative Power-Supply Voltage
3	4	—	—	—	—	IN-	Inverting Amplifier Input
4	1	—	—	—	—	OUT	Amplifier Output
5	6	8	C2	10	C2	V <sub>DD</sub>	Positive Power-Supply Voltage
—	5	—	—	6	B2	REF	Reference Voltage Output
—	—	1	C1	1	C1	OUTA	Amplifier Output (Channel A)
—	—	2	B1	2	B1	INA-	Inverting Amplifier Input (Channel A)
—	—	3	A1	3	A1	INA+	Noninverting Amplifier Input (Channel A)
—	—	5	A3	7	A3	INB+	Noninverting Amplifier Input (Channel B)
—	—	6	B3	8	B3	INB-	Inverting Amplifier Input (Channel B)
—	—	7	C3	9	C3	OUTB	Amplifier Output (Channel B)
—	—	—	B2	4	—	N.C.	No Connection. Not internally connected.
—	—	—	—	—	—	EP (TDFN only)	Exposed Paddle. Solder EP to V <sub>SS</sub> or leave unconnected (TDFN packages only).

## Detailed Description

The MAX4036–MAX4039 consume an ultra-low supply current and have rail-to-rail output stages specifically designed for low-voltage operation. The input common-mode voltage range extends from V<sub>DD</sub> - 0.4V to V<sub>SS</sub>, although full rail-to-rail input range is possible with degraded performance when operating from a supply voltage above 3.0V. The input offset voltage is typically 200 $\mu$ V. Low-operating supply voltage, low supply current, and rail-to-rail outputs make the MAX4036–MAX4039 an excellent choice for precision or general-purpose low-voltage, battery-powered systems.

### Rail-to-Rail Outputs

The MAX4036–MAX4039 output stages can drive a 5k $\Omega$  load and still swing to within 40mV of the rails. Figure 1 shows the output voltage swing of the MAX4036–MAX4039 configured as a unity-gain buffer, powered from a single 2.4V supply. The output for this setup typically swings from 5mV to V<sub>DD</sub> - 5mV with a 100k $\Omega$  load.

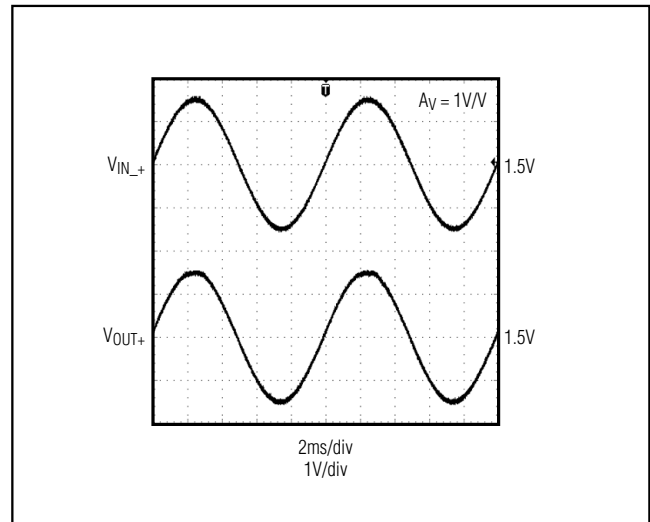

Figure 1. Rail-to-Rail Input/Output Voltage Range

# Low IBIAS, +1.4V/800nA, Rail-to-Rail Op Amps with +1.2V Buffered Reference

## Applications Information

### Power-Supply Considerations

The MAX4036-MAX4039 operate from a single 1.4V (MAX4036/MAX4038) or 1.8V (MAX4037/MAX4039) to 3.6V supply. A high amplifier power-supply rejection ratio of 82dB and the excellent reference line regulation allow the devices to be powered directly from a decaying battery voltage, simplifying design and extending battery life. The MAX4036-MAX4039 are ideally suited for low-voltage battery-powered systems. The *Typical Operating Characteristics* show the changes in supply current and reference output as a function of supply voltage.

### Power-Up Settling Time

The MAX4036-MAX4039 typically require 0.25ms to power-up. During this startup time, the output is indeterminate. The application circuit should allow for this initial delay. See the *Typical Operating Characteristics* for amplifier and reference settling time curves.

### Driving Capacitive Loads: Op Amps

The MAX4036-MAX4039 amplifier(s) require no output capacitor for stability, and are unity-gain stable for loads up to 5000pF. Applications that require greater capacitive-drive capability should use an isolation resistor between the output and the capacitive load (Figure 2). Note that this solution reduces the gain and output voltage swing because  $R_{ISO}$  forms a voltage-divider with the load resistor.

### Crossover Distortion

The MAX4036-MAX4039 output stages are capable of sourcing and sinking currents with orders of magnitude greater than the stages' quiescent current, which is less than 1 $\mu$ A. This ability to drive heavy loads with such a small quiescent current introduces crossover

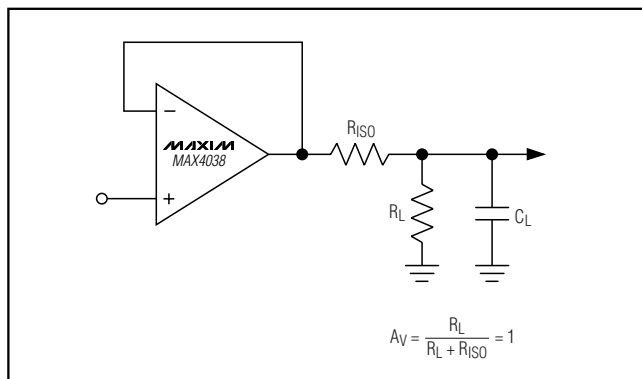

Figure 2. Using a Resistor to Isolate a Capacitive Load from the Op Amp

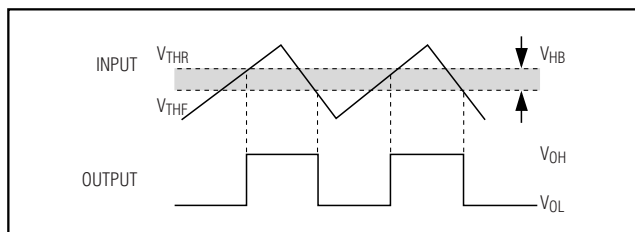

Figure 3. Hysteresis

distortion as the output stage passes between sinking and sourcing. In the crossover regions, the output impedance of the MAX4036-MAX4039 increases substantially, thereby changing the load-driving characteristics. The distortion can be greatly reduced by increasing the load resistance. For applications where low load resistance is required, bias the load such that the output current is always in one direction, to avoid crossover distortion.

### Reference Bypassing

The MAX4037/MAX4039 reference requires no external capacitors.

### Using the MAX4036-MAX4039 as a Comparator

Although optimized for use as an operational amplifier, the MAX4036-MAX4039 can be used as a rail-to-rail I/O comparator (Figures 3, 4). External hysteresis can be used to minimize the risk of output oscillation. The positive feedback circuit, shown in Figure 4, causes the input threshold to change when the output voltage changes state.

### Battery Monitoring Using the MAX4037/MAX4039 and Hysteresis

The internal reference and low operating voltage of the MAX4037/MAX4039 make the devices ideal for battery-monitoring applications. Hysteresis can be set using resistors as shown in Figure 4, and the following design procedure:

- 1) Choose  $R_3$ . The input bias current of  $IN_-$  is under 100pA over temperature, so a current through  $R_3$  around 100nA maintains accuracy. The current through  $R_3$  at the trip point is  $V_{REF} / R_3$ , or 100nA for  $R_3 = 12M\Omega$ .  $10M\Omega$  is a good practical value.
- 2) Choose the hysteresis voltage ( $V_{HB}$ ), the voltage between the upper and lower thresholds. In this example, choose  $V_{HB} = 50mV$  (see Figure 3).

# Low IBIAS, +1.4V/800nA, Rail-to-Rail Op Amps with +1.2V Buffered Reference

3) Calculate R1:

$$\begin{aligned} R1 &= R3 \times \frac{V_{HB}}{V_{DD}} \\ &= 10M\Omega \times \frac{0.5V}{2.4V} \\ &= 210k\Omega \end{aligned}$$

4) Choose the threshold voltage for  $V_{IN}$  rising ( $V_{THR}$ ). In this example, choose  $V_{THR} = 2.0V$ .

5) Calculate R2:

$$\begin{aligned} R2 &= \frac{1}{\left[ \left( \frac{V_{THR}}{V_{REF} \times R1} \right) - \frac{1}{R1} - \frac{1}{R3} \right]} \\ &= \frac{1}{\left[ \left( \frac{2.0V}{1.2V \times 210k\Omega} \right) - \frac{1}{210k\Omega} - \frac{1}{10M\Omega} \right]} \\ &= 325k\Omega \end{aligned}$$

6) Verify the threshold voltages with these formulas:

$V_{IN}$  rising:

$$V_{THR} = V_{REF} \times R1 \times \left( \frac{1}{R1} + \frac{1}{R2} + \frac{1}{R3} \right)$$

$V_{IN}$  falling:

$$V_{THF} = V_{THR} - \left( \frac{R1 \times V_{DD}}{R3} \right)$$

In this application, the MAX4036-MAX4039 supply current will vary, depending on the output state of the comparator.

### Power Supplies and Layout

The MAX4036-MAX4039 operate from a single 1.4V (MAX4036/MAX4038) or 1.8V (MAX4037/MAX4039) to 3.6V power supply. Bypass  $V_{DD}$  with a 0.1 $\mu$ F capacitor to ground to minimize noise.

Good layout techniques optimize performance by decreasing the amount of stray capacitance to the op amp's inputs and outputs. To decrease stray capacitance, minimize trace lengths by placing external components close to the device.

The exposed paddle (EP) on the TDFN packages of the MAX4038 and MAX4039 is internally connected to the device substrate,  $V_{SS}$ . Connect the exposed paddle to  $V_{SS}$  or leave EP unconnected. Running traces below the exposed paddle is not recommended.

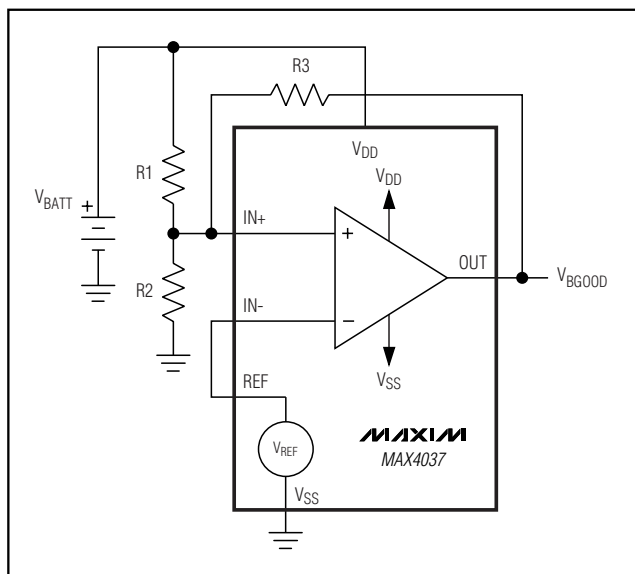

Figure 4. Battery Monitoring

### Selector Guide

PART	NO. OF AMPLIFIERS	REFERENCE
MAX4036	1	—
MAX4037	1	✓
MAX4038	2	—
MAX4039	2	✓

### Chip Information

MAX4036 TRANSISTOR COUNT: 49  
 MAX4037 TRANSISTOR COUNT: 119  
 MAX4038 TRANSISTOR COUNT: 146  
 MAX4039 TRANSISTOR COUNT: 146  
 PROCESS: BiCMOS

# Low IBIAS, +1.4V/800nA, Rail-to-Rail Op Amps with +1.2V Buffered Reference

## Pin Configurations

**MAX4036-MAX4039**

TOP VIEW

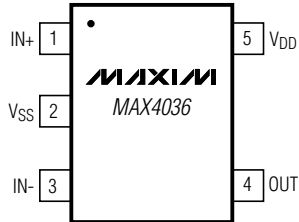

**SC70**

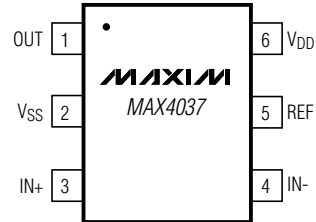

**SOT23**

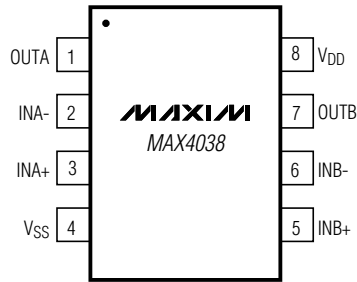

**μMAX**

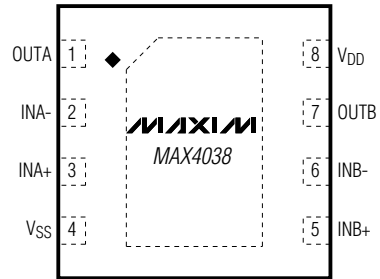

**3mm x 3mm x 0.8mm TDFN**  
TDFN EXPOSED PAD CONNECTED TO V<sub>SS</sub>.

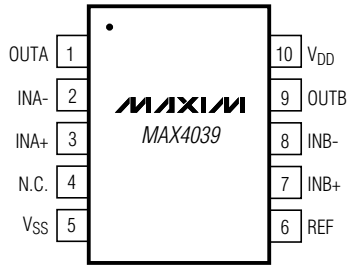

**μMAX**

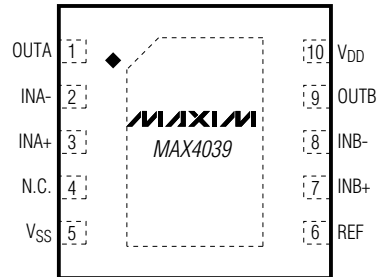

**3mm x 3mm x 0.8mm TDFN**  
TDFN EXPOSED PAD CONNECTED TO V<sub>SS</sub>.

(BUMP SIDE DOWN)

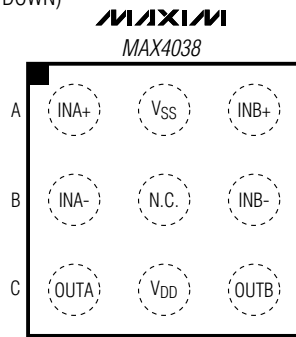

**UCSP**

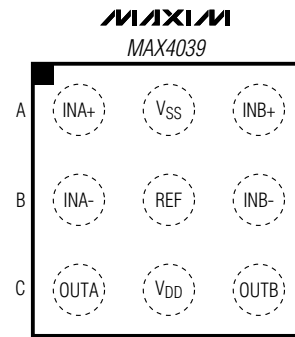

**UCSP**

# Low IBIAS, +1.4V/800nA, Rail-to-Rail Op Amps with +1.2V Buffered Reference

## Package Information

(The package drawing(s) in this data sheet may not reflect the most current specifications. For the latest package outline information, go to [www.maxim-ic.com/packages](http://www.maxim-ic.com/packages).)

COMMON DIMENSIONS		
SYMBOL	MIN	MAX
A	0.80	1.10
A1	0.00	0.10
A2	0.80	1.00
b	0.15	0.30
c	0.10	0.18
D	1.80	2.20
e	0.65 BSC.	
E	1.15	1.35
HE	1.80	2.40
L	0.10	0.40
L1	0.425 TYP.	
Q1	0.10	0.40

NOTE:

1. ALL DIMENSIONS ARE IN MILLIMETERS.
2. DIMENSIONS ARE INCLUSIVE OF PLATING.
3. DIMENSIONS ARE EXCLUSIVE OF MOLD FLASH & METAL BURR.
4. COMPLY TO EIAJ SC70 EXCEPT FOR PIN COUNT AND DIMENSION "b".
5. COPLANARITY 4 MILS. MAX.
6. FOOT LENGTH MEASURED AT INTERCEPT POINT BETWEEN DATUM "A" AND LEAD SURFACE.
7. MARKING IS FOR PACKAGE ORIENTATION REFERENCE ONLY.
8. LEAD CENTERLINES TO BE AT TRUE POSITION AS DEFINED BY BASIC DIMENSION "e", ±0.05.

SC70, 5L EFS

-DRAWING NOT TO SCALE-

TITLE: PACKAGE OUTLINE, 5L SC70	
APPROVAL	DOCUMENT CONTROL NO. 21-0076
REV. C	1/1

# Low IBIAS, +1.4V/800nA, Rail-to-Rail Op Amps with +1.2V Buffered Reference

## Package Information (continued)

(The package drawing(s) in this data sheet may not reflect the most current specifications. For the latest package outline information, go to [www.maxim-ic.com/packages](http://www.maxim-ic.com/packages).)

MAX4036-MAX4039

6LSOT-EPS

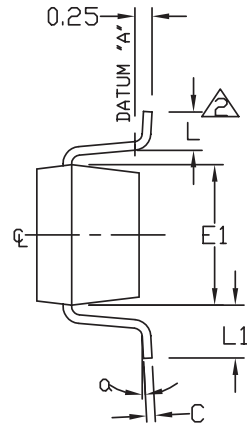
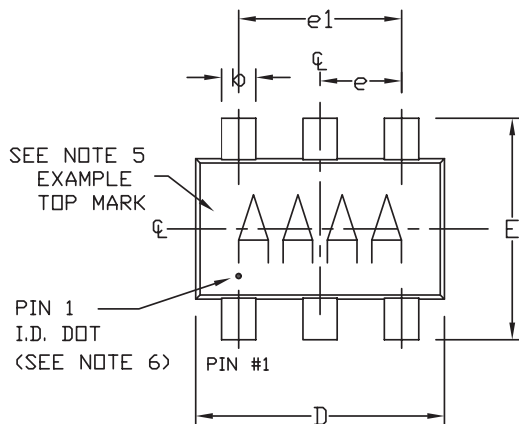

SYMBOL	MIN	MAX
A	0.90	1.45
A1	0.00	0.15
A2	0.90	1.30
b	0.35	0.50
C	0.08	0.20
D	2.80	3.00
E	2.60	3.00
E1	1.50	1.75
L	0.35	0.60
L1	0.60	REF.
e1	1.90	BSC.
e	0.95	BSC.
a	0°	10°

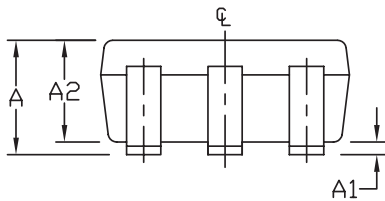

**NOTES:**

1. ALL DIMENSIONS ARE IN MILLIMETERS.
2. FOOT LENGTH MEASURED AT INTERCEPT POINT BETWEEN DATUM A & LEAD SURFACE.
3. PACKAGE OUTLINE EXCLUSIVE OF MOLD FLASH & METAL BURR. MOLD FLASH, PROTRUSION OR METAL BURR SHOULD NOT EXCEED 0.25 MM.
4. PACKAGE OUTLINE INCLUSIVE OF SOLDER PLATING.
5. PIN 1 IS LOWER LEFT PIN WHEN READING TOP MARK FROM LEFT TO RIGHT. (SEE EXAMPLE TOP MARK)
6. PIN 1 I.D. DOT IS 0.3 MM Ø MIN. LOCATED ABOVE PIN 1.
7. MEETS JEDEC MO178, VARIATION AB.
8. SOLDER THICKNESS MEASURED AT FLAT SECTION OF LEAD BETWEEN 0.08mm AND 0.15mm FROM LEAD TIP.
9. LEAD TO BE COPLANAR WITHIN 0.1 MM.

<small>PROPRIETARY INFORMATION</small>		
<small>TITLE:</small> PACKAGE OUTLINE, SOT-23, 6L		
<small>APPROVAL</small>	<small>DOCUMENT CONTROL NO.</small> 21-0058	<small>REV.</small> F 1/1

# Low IBIAS, +1.4V/800nA, Rail-to-Rail Op Amps with +1.2V Buffered Reference

## Package Information (continued)

(The package drawing(s) in this data sheet may not reflect the most current specifications. For the latest package outline information, go to [www.maxim-ic.com/packages](http://www.maxim-ic.com/packages).)

8LUMAXD EPS

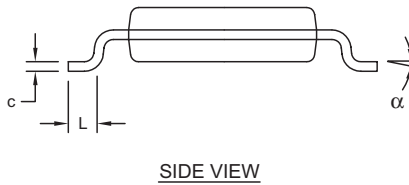
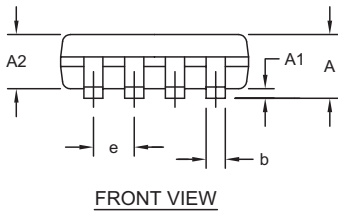
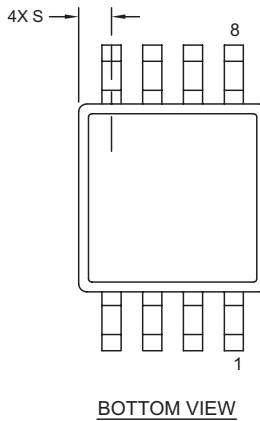
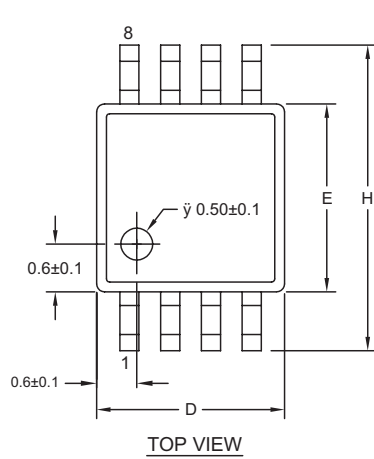

DIM	INCHES		MILLIMETERS	
	MIN	MAX	MIN	MAX
A	-	0.043	-	1.10
A1	0.002	0.006	0.05	0.15
A2	0.030	0.037	0.75	0.95
b	0.010	0.014	0.25	0.36
c	0.005	0.007	0.13	0.18
D	0.116	0.120	2.95	3.05
e	0.0256 BSC		0.65 BSC	
E	0.116	0.120	2.95	3.05
H	0.188	0.198	4.78	5.03
L	0.016	0.026	0.41	0.66
α	0°	6°	0°	6°
S	0.0207 BSC		0.5250 BSC	

**NOTES:**

1. D&E DO NOT INCLUDE MOLD FLASH.
2. MOLD FLASH OR PROTRUSIONS NOT TO EXCEED 0.15MM (.006").
3. CONTROLLING DIMENSION: MILLIMETERS.
4. MEETS JEDEC MO-187C-AA.

<small>PROPRIETARY INFORMATION</small>	
<small>TITLE:</small> <b>PACKAGE OUTLINE, 8L uMAX/uSOP</b>	
<small>APPROVAL</small>	<small>DOCUMENT CONTROL NO.</small> <b>21-0036</b>
<small>REV.</small> <b>J</b>	<small>1/1</small>



# Low IBIAS, +1.4V/800nA, Rail-to-Rail Op Amps with +1.2V Buffered Reference

## Package Information (continued)

(The package drawing(s) in this data sheet may not reflect the most current specifications. For the latest package outline information, go to [www.maxim-ic.com/packages](http://www.maxim-ic.com/packages).)

MAX4036-MAX4039

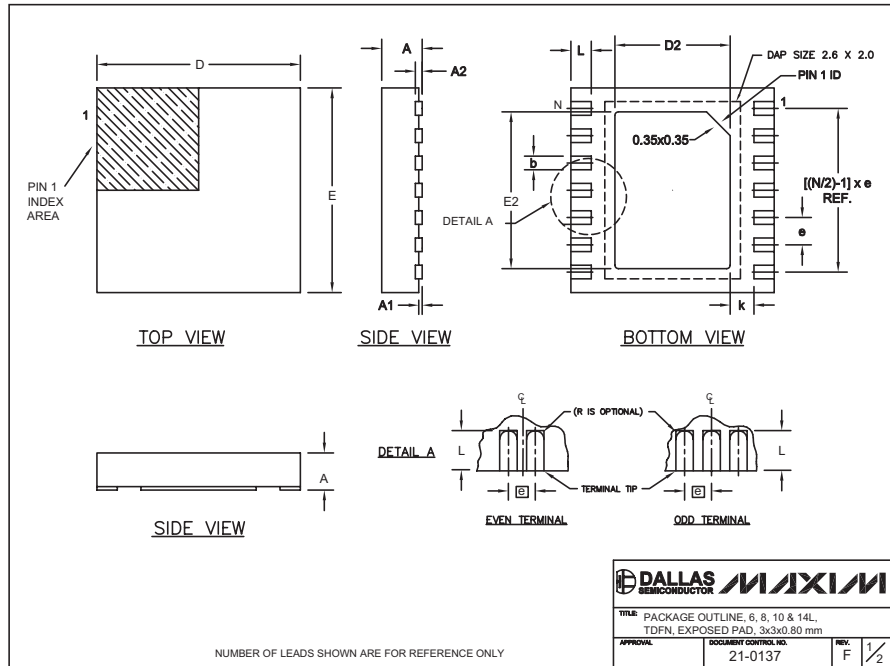

COMMON DIMENSIONS		
SYMBOL	MIN.	MAX.
A	0.70	0.80
D	2.90	3.10
E	2.90	3.10
A1	0.00	0.05
L	0.20	0.40
k	0.25 MIN.	
A2	0.20 REF.	

PACKAGE VARIATIONS							
PKG. CODE	N	D2	E2	e	JEDEC SPEC	b	[(N/2)-1] x e
T633-1	6	1.50±0.10	2.30±0.10	0.95 BSC	MO229 / WEEA	0.40±0.05	1.90 REF
T833-1	8	1.50±0.10	2.30±0.10	0.65 BSC	MO229 / WEEC	0.30±0.05	1.95 REF
T1033-1	10	1.50±0.10	2.30±0.10	0.50 BSC	MO229 / WEED-3	0.25±0.05	2.00 REF
T1433-1	14	1.70±0.10	2.30±0.10	0.40 BSC	----	0.20±0.03	2.40 REF
T1433-2	14	1.70±0.10	2.30±0.10	0.40 BSC	----	0.20±0.03	2.40 REF

**NOTES:**

1. ALL DIMENSIONS ARE IN mm. ANGLES IN DEGREES.
2. COPLANARITY SHALL NOT EXCEED 0.08 mm.
3. WARPAGE SHALL NOT EXCEED 0.10 mm.
4. PACKAGE LENGTH/PACKAGE WIDTH ARE CONSIDERED AS SPECIAL CHARACTERISTIC(S).
5. DRAWING CONFORMS TO JEDEC MO229, EXCEPT DIMENSIONS "D2" AND "E2", AND T1433-1 & T1433-2.
6. "N" IS THE TOTAL NUMBER OF LEADS.

DALLAS SEMICONDUCTOR **MAXIM**

TITLE: PACKAGE OUTLINE, 6, 8, 10 & 14L, TDFN, EXPOSED PAD, 3x3x0.80 mm

APPROVAL	DOCUMENT CONTROL NO. 21-0137	REV. F	1/2
----------	---------------------------------	-----------	-----

# Low IBIAS, +1.4V/800nA, Rail-to-Rail Op Amps with +1.2V Buffered Reference

## Package Information (continued)

(The package drawing(s) in this data sheet may not reflect the most current specifications. For the latest package outline information, go to [www.maxim-ic.com/packages](http://www.maxim-ic.com/packages).)

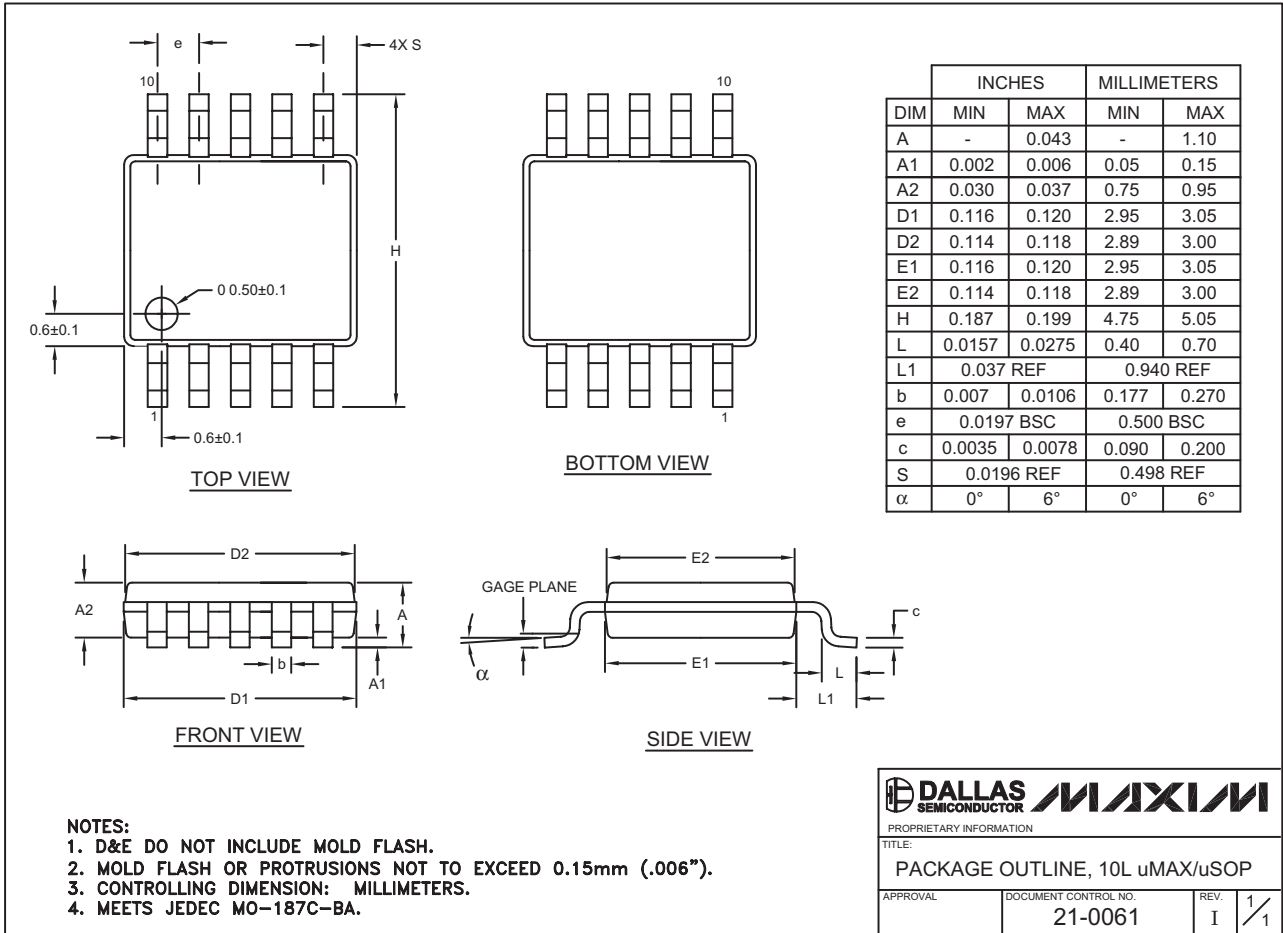

10LUMAX/EPS

# Low IBIAS, +1.4V/800nA, Rail-to-Rail Op Amps with +1.2V Buffered Reference

## Package Information (continued)

(The package drawing(s) in this data sheet may not reflect the most current specifications. For the latest package outline information, go to [www.maxim-ic.com/packages](http://www.maxim-ic.com/packages).)

**MAX4036-MAX4039**

**TOP VIEW**

COMMON DIMENSIONS	
A	0.62±0.05-0.08
A1	0.29±0.02
A2	0.33 REF.
b	∅0.35±0.03
D1	1.00 BASIC
E1	1.00 BASIC
e	0.50 BASIC
SD	0.00 BASIC
SE	0.00 BASIC

PKG. CODE	VARIABLE DIMENSIONS		DEPOPULATED SOLDER BALLS
	D	E	
B9-1	1.52±0.05	1.52±0.05	NONE
B9-2	1.52±0.05	1.52±0.05	B2
B9-3	1.52±0.05	1.52±0.05	B1, B2, B3
B9-4	1.60±0.05	1.60±0.05	NONE
B9-5	1.60±0.05	1.60±0.05	B2
B9-6	1.60±0.05	1.60±0.05	B1, B2, B3

**NOTES:**

- ALL DIMENSIONS ARE IN MILLIMETERS.
- PRODUCT MARKING: NUMBER OF CHARACTERS AND LINES VARY PER PRODUCT.

**BOTTOM VIEW**

**SIDE VIEW**

<b>DALLAS SEMICONDUCTOR</b>		<b>MAXIM</b>	
PROPRIETARY INFORMATION			
TITLE			
PACKAGE OUTLINE, 3x3 UCSP			
APPROVAL	DOCUMENT CONTROL NO.	REV.	1/1
	21-0093	I	

Maxim cannot assume responsibility for use of any circuitry other than circuitry entirely embodied in a Maxim product. No circuit patent licenses are implied. Maxim reserves the right to change the circuitry and specifications without notice at any time.

**Maxim Integrated Products, 120 San Gabriel Drive, Sunnyvale, CA 94086 408-737-7600** \_\_\_\_\_ 19