

## NPN Silicon RF Transistor

**BFQ 71**

- For broadband amplifiers up to 2 GHz and fast non-saturated switches at collector currents from 1 mA to 20 mA.
- Hermetically sealed ceramic package.
- HiRel/Mil screening available.
- CECC-type available: CECC 50002/260.

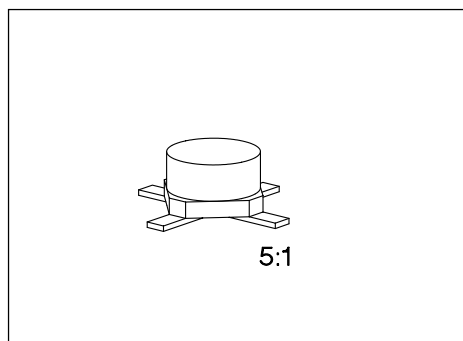

**ESD: Electrostatic discharge sensitive device, observe handling precautions!**

Type	Marking	Ordering Code (tape and reel)	Pin Configuration				Package <sup>1)</sup>
			1	2	3	4	
BFQ 71	71	Q62702-F775	B	E	C	E	Cerrec-X

### Maximum Ratings

Parameter	Symbol	Values	Unit
Collector-emitter voltage	$V_{CE0}$	15	V
Collector-emitter voltage, $V_{BE} = 0$	$V_{CES}$	20	
Collector-base voltage	$V_{CB0}$	20	
Emitter-base voltage	$V_{EB0}$	2.5	
Collector current	$I_C$	30	mA
Base current	$I_B$	4	
Total power dissipation, $T_s \leq 103 \text{ }^\circ\text{C}^3)$	$P_{tot}$	300	mW
Junction temperature	$T_j$	175	$^\circ\text{C}$
Ambient temperature range	$T_A$	- 65 ... + 175	
Storage temperature range	$T_{stg}$	- 65 ... + 175	

### Thermal Resistance

Junction - ambient <sup>2)</sup>	$R_{th JA}$	$\leq 320$	K/W
Junction - soldering point <sup>3)</sup>	$R_{th JS}$	$\leq 240$	

1) For detailed dimensions see chapter Package Outlines.

2) Package mounted on alumina 15 mm × 16.7 mm × 0.7 mm.

3)  $T_s$  is measured on the collector lead at the soldering point to the pcb.

## Electrical Characteristics

at  $T_A = 25\text{ °C}$ , unless otherwise specified.

Parameter	Symbol	Values			Unit
		min.	typ.	max.	

## DC Characteristics

Collector-emitter breakdown voltage $I_C = 1\text{ mA}, I_B = 0$	$V_{(BR)CE0}$	15	–	–	V
Collector-base cutoff current $V_{CB} = 10\text{ V}, I_E = 0$	$I_{CB0}$	–	–	50	nA
Emitter-base cutoff current $V_{EB} = 2\text{ V}, I_C = 0$	$I_{EB0}$	–	–	10	$\mu\text{A}$
DC current gain $I_C = 5\text{ mA}, V_{CE} = 6\text{ V}$ $I_C = 20\text{ mA}, V_{CE} = 6\text{ V}$	$h_{FE}$	40 40	90 100	250 –	–
Collector-emitter saturation voltage $I_C = 30\text{ mA}, I_B = 3\text{ mA}$	$V_{CEsat}$	–	0.16	0.4	V
Base-emitter voltage $I_C = 5\text{ mA}, V_{CE} = 6\text{ V}$	$V_{BE}$	–	0.78	–	

## Electrical Characteristics

at  $T_A = 25\text{ }^\circ\text{C}$ , unless otherwise specified.

Parameter	Symbol	Values			Unit
		min.	typ.	max.	

## AC Characteristics

Transition frequency $I_C = 5\text{ mA}$ , $V_{CE} = 6\text{ V}$ , $f = 200\text{ MHz}$ $I_C = 20\text{ mA}$ , $V_{CE} = 6\text{ V}$ , $f = 200\text{ MHz}$	$f_t$	– 4	4.2 5.2	– –	GHz
Collector-base capacitance $V_{CB} = 6\text{ V}$ , $V_{BE} = v_{be} = 0$ , $f = 1\text{ MHz}$	$C_{cb}$	–	0.46	0.6	pF
Collector-emitter capacitance $V_{CE} = 6\text{ V}$ , $V_{BE} = v_{be} = 0$ , $f = 1\text{ MHz}$	$C_{ce}$	–	0.4	–	
Input capacitance $V_{EB} = 0.5\text{ V}$ , $I_C = i_c = 0$ , $f = 1\text{ MHz}$	$C_{ibo}$	–	1.2	–	
Output capacitance $V_{CE} = 6\text{ V}$ , $V_{BE} = v_{be} = 0$ , $f = 1\text{ MHz}$	$C_{obs}$	–	0.86	1.2	
Noise figure $I_C = 5\text{ mA}$ , $V_{CE} = 6\text{ V}$ , $f = 10\text{ MHz}$ , $Z_S = 75\text{ }\Omega$ $I_C = 2\text{ mA}$ , $V_{CE} = 6\text{ V}$ , $f = 800\text{ MHz}$ , $Z_S = Z_{Sopt}$ $I_C = 3\text{ mA}$ , $V_{CE} = 10\text{ V}$ , $f = 2\text{ GHz}$ , $Z_S = Z_{Sopt}$	$F$	– – –	1.4 1.5 3.2	2.2 3 –	dB
Power gain $I_C = 2\text{ mA}$ , $V_{CE} = 6\text{ V}$ , $f = 800\text{ MHz}$ , $Z_S = Z_{Sopt}$ , $Z_L = Z_{Lopt}$	$G_{pe}$	–	15	–	
Transducer gain $I_C = 20\text{ mA}$ , $V_{CE} = 6\text{ V}$ , $f = 1\text{ GHz}$ , $Z_0 = 50\text{ }\Omega$	$ S_{21e} ^2$	–	13.4	–	
Linear output voltage two-tone intermodulation test $I_C = 15\text{ mA}$ , $V_{CE} = 10\text{ V}$ , $d_{IM} = 60\text{ dB}$ , $f_1 = 806\text{ MHz}$ , $f_2 = 810\text{ MHz}$ , $Z_S = Z_L = 50\text{ }\Omega$	$V_{o1} = V_{o2}$	–	110	–	mV
Third order intercept point $I_C = 15\text{ mA}$ , $V_{CE} = 10\text{ V}$ , $f = 800\text{ MHz}$	$IP_3$	–	23.5	–	dBm

### Total power dissipation $P_{tot} = f(T_A^*; T_S)$

\*Package mounted on alumina

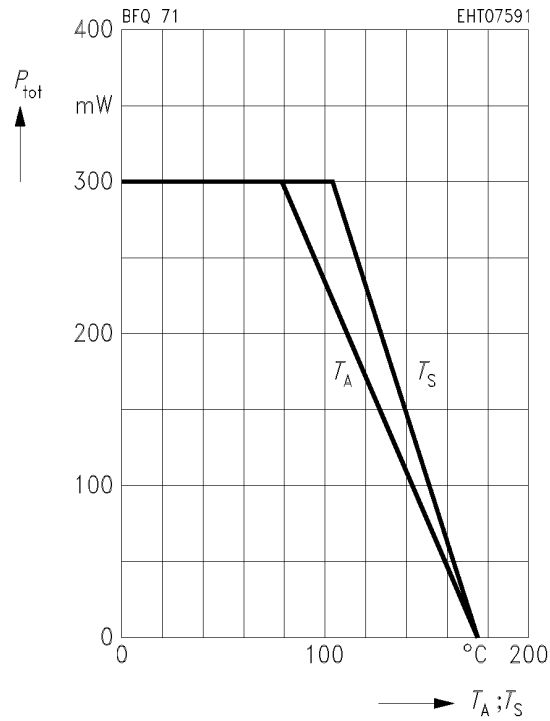

### Transition frequency $f_T = f(I_C)$

$V_{CE} = 6\text{ V}, f = 200\text{ MHz}$

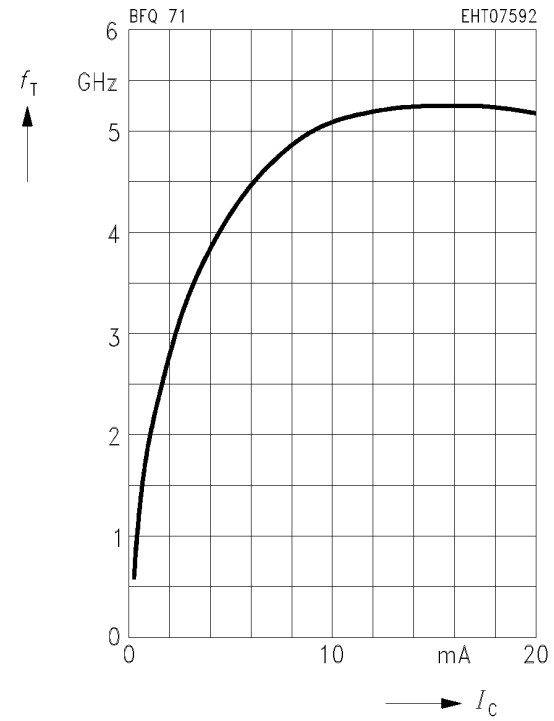

### Collector-base capacitance $C_{cb} = f(V_{CB})$

$V_{BE} = v_{be} = 0, f = 1\text{ MHz}$

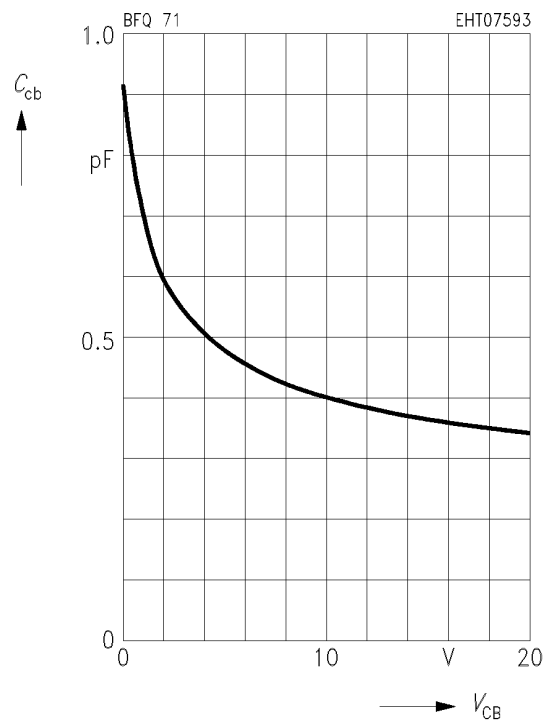

### Common Emitter Noise Parameters

$f$	$F_{min}$	$G_p(F_{min})$	$\Gamma_{opt}$		$R_N$	$N$	$F_{50 \Omega}$	$G_p(F_{50 \Omega})$
GHz	dB	dB	MAG	ANG	$\Omega$	-	dB	dB

$I_C = 2 \text{ mA}, V_{CE} = 6 \text{ V}, Z_0 = 50 \Omega$

0.01	1.1	-	(Z <sub>s</sub> = 150 Ω)		-	-	1.6	-
------	-----	---	--------------------------	--	---	---	-----	---

$I_C = 5 \text{ mA}, V_{CE} = 10 \text{ V}, Z_0 = 50 \Omega$

0.01	1.3	-	(Z <sub>s</sub> = 100 Ω)		-	-	1.7	-
0.8	1.6	15.3	0.29	56	18.5	0.24	1.8	14.8
2.0	3.1	9	0.12	124.5	30	0.67	-	-

### Noise figure $F = f(Z_s)$

$V_{CE} = 6 \text{ V}, f = 10 \text{ MHz}$

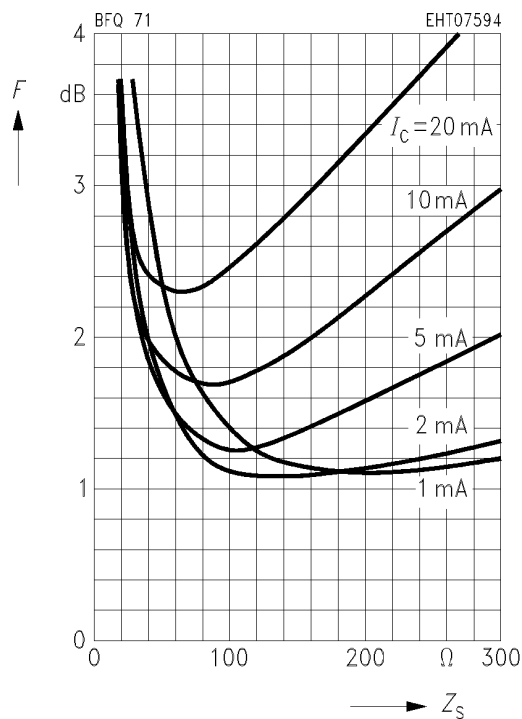

**Circles of constant noise figure  $F = f(Z_S)$  and available power gain  $G_{av} = f(Z_S)$**

$I_C = 5 \text{ mA}$ ,  $V_{CE} = 10 \text{ V}$ ,  $f = 800 \text{ MHz}$

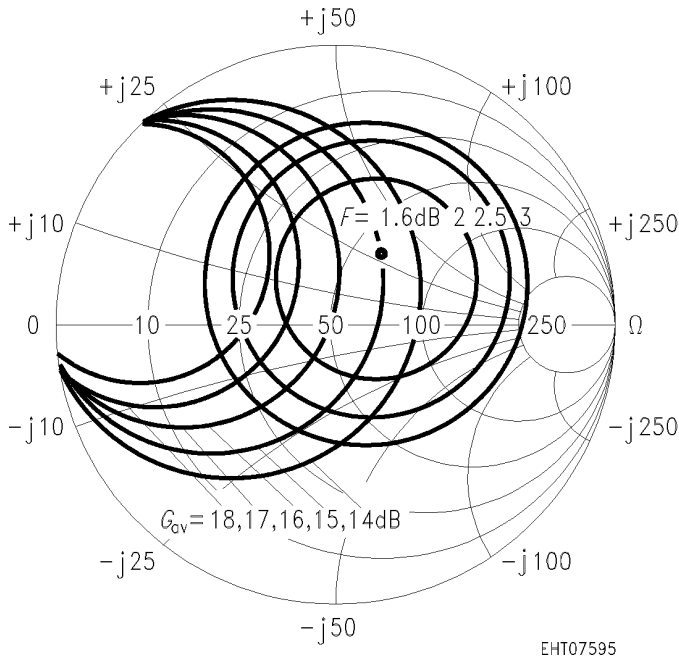

**Noise figure  $F = f(I_C)$**

**Power gain  $G = f(I_C)$**

$V_{CE} = 10 \text{ V}$ ,  $f = 800 \text{ MHz}$ ,  $Z_{Lopt}(G)$

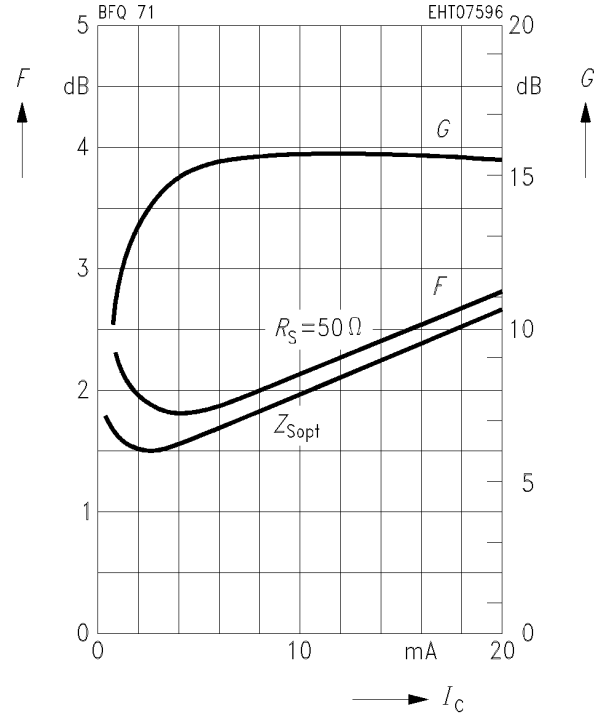

**Circles of constant noise figure  $F = f(Z_S)$  and available power gain  $G_{av} = f(Z_S)$**

$I_C = 5 \text{ mA}$ ,  $V_{CE} = 10 \text{ V}$ ,  $f = 2 \text{ GHz}$

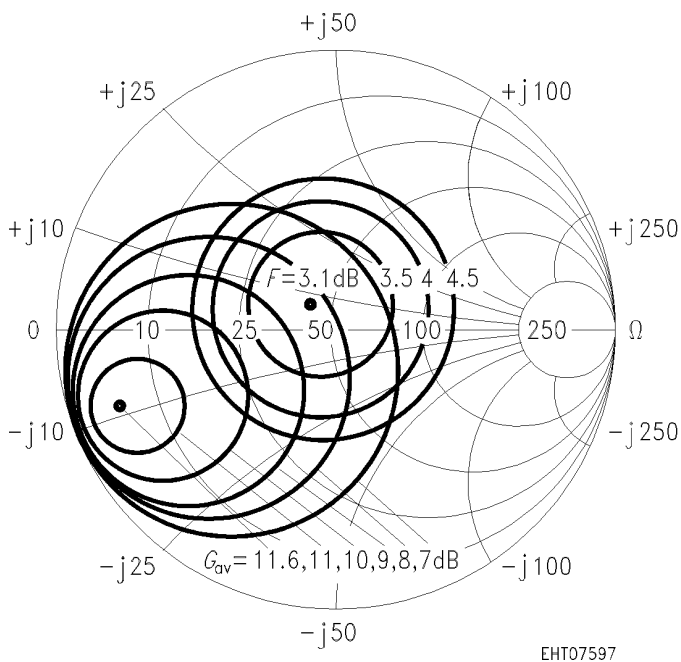

**Noise figure  $F = f(I_C)$**

**Power gain  $G = f(I_C)$**

$V_{CE} = 10 \text{ V}$ ,  $f = 2 \text{ GHz}$ ,  $Z_{Lopt}(G)$

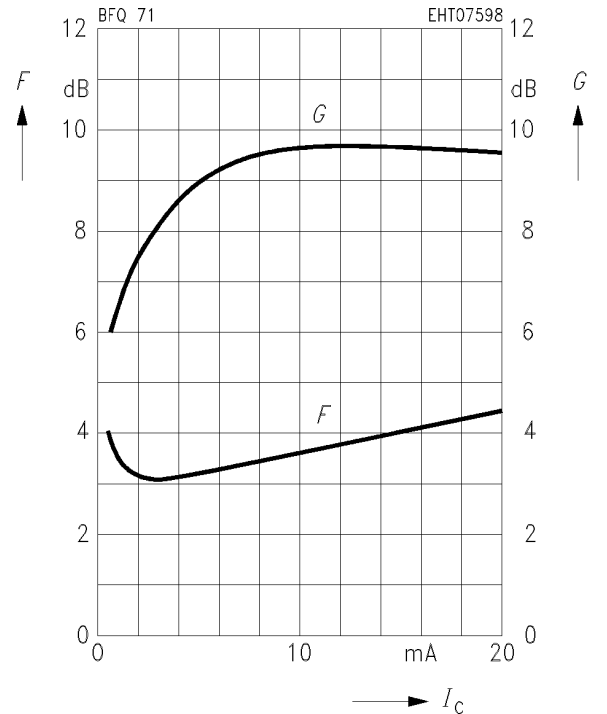

## Common Emitter Power Gain

### Power gain $G_{ms}, |S_{21e}|^2 = f(I_C)$

$V_{CE} = 6 \text{ V}, f = 200 \text{ MHz}, Z_0 = 50 \Omega$

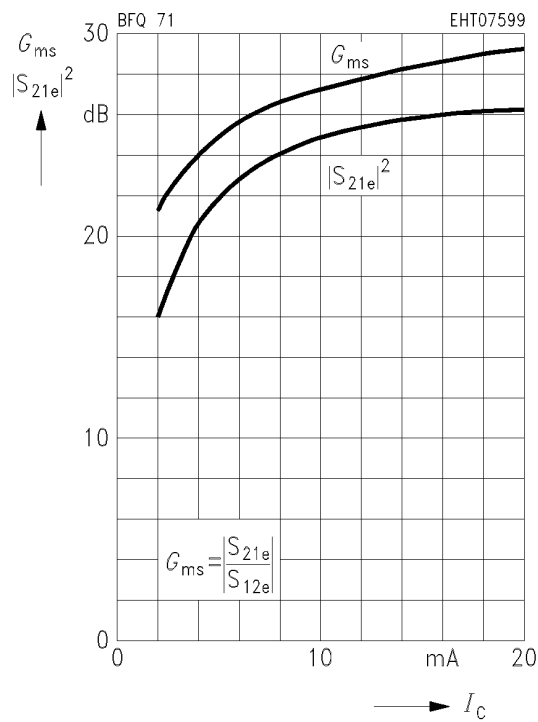

### Power gain $G_{ms}, |S_{21e}|^2 = f(I_C)$

$V_{CE} = 6 \text{ V}, f = 500 \text{ MHz}, Z_0 = 50 \Omega$

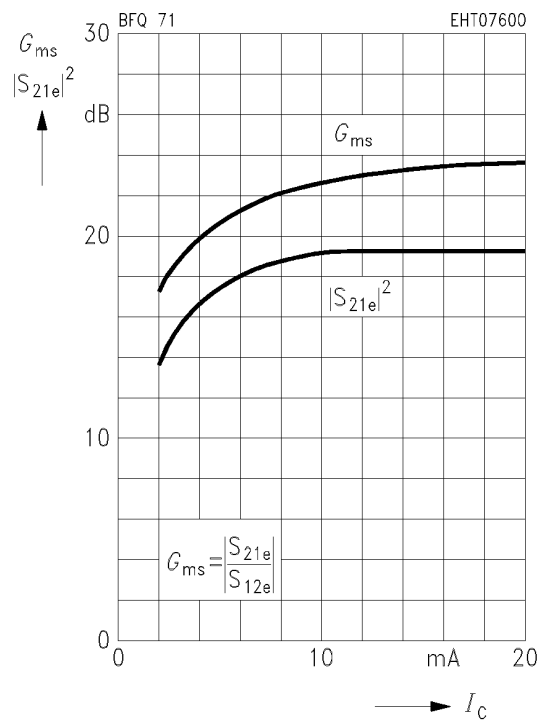

### Power gain $G_{ms}, |S_{21e}|^2 = f(I_C)$

$V_{CE} = 6 \text{ V}, f = 800 \text{ MHz}, Z_0 = 50 \Omega$

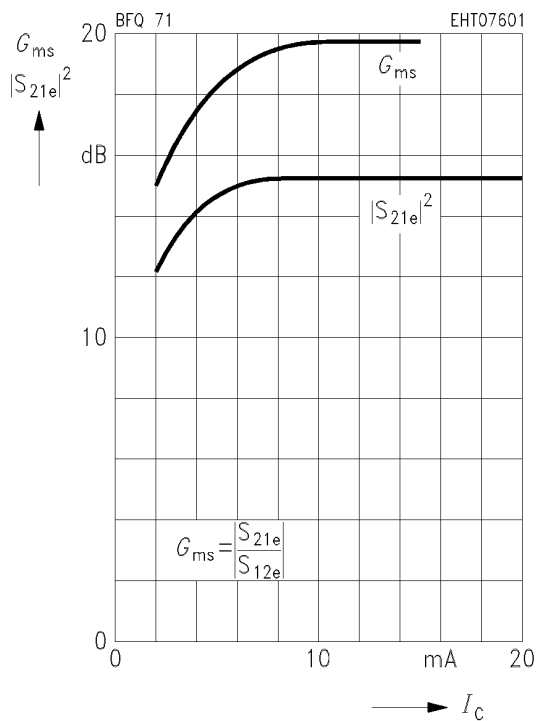

### Power gain $G_{ma}, |S_{21e}|^2 = f(I_C)$

$V_{CE} = 6 \text{ V}, f = 2 \text{ GHz}, Z_0 = 50 \Omega$

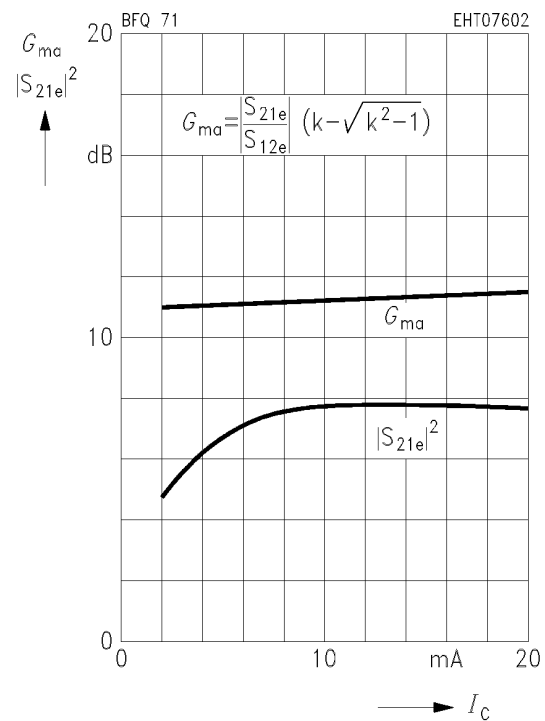

**Power gain  $G_{ms}$ ,  $|S_{21e}|^2 = f(f)$**   
 $I_C = 2 \text{ mA}$ ,  $V_{CE} = 6 \text{ V}$ ,  $Z_0 = 50 \Omega$

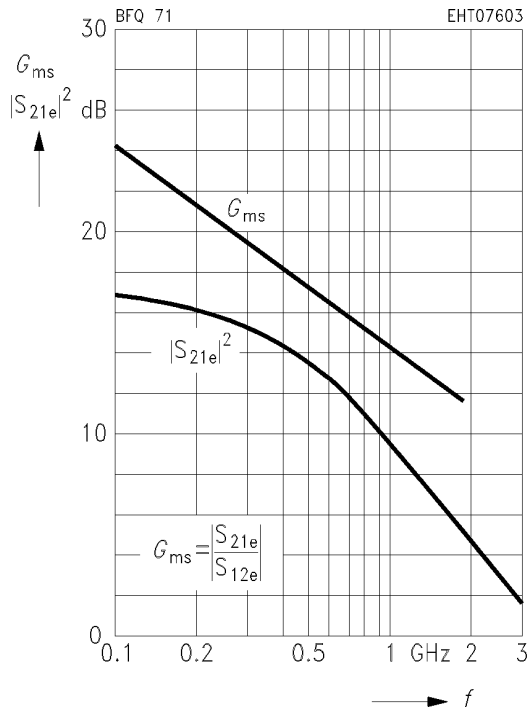

**Power gain  $G_{ma}$ ,  $G_{ms}$ ,  $|S_{21e}|^2 = f(f)$**   
 $I_C = 5 \text{ mA}$ ,  $V_{CE} = 6 \text{ V}$ ,  $Z_0 = 50 \Omega$

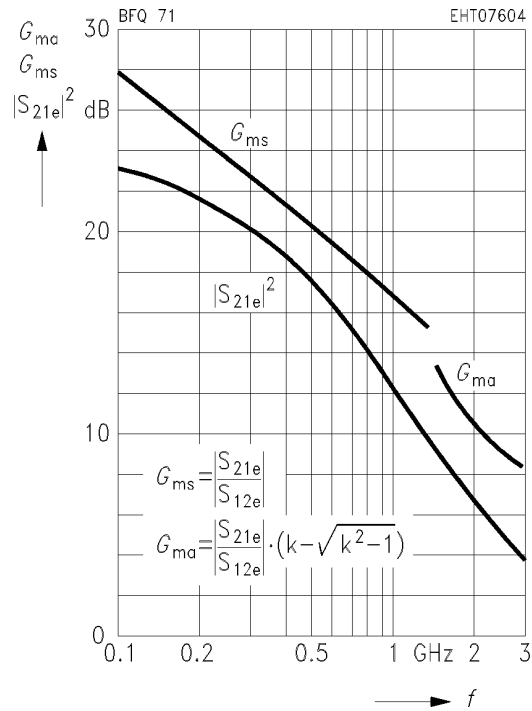

**Power gain  $G_{ma}$ ,  $G_{ms}$ ,  $|S_{21e}|^2 = f(f)$**   
 $I_C = 10 \text{ mA}$ ,  $V_{CE} = 6 \text{ V}$ ,  $Z_0 = 50 \Omega$

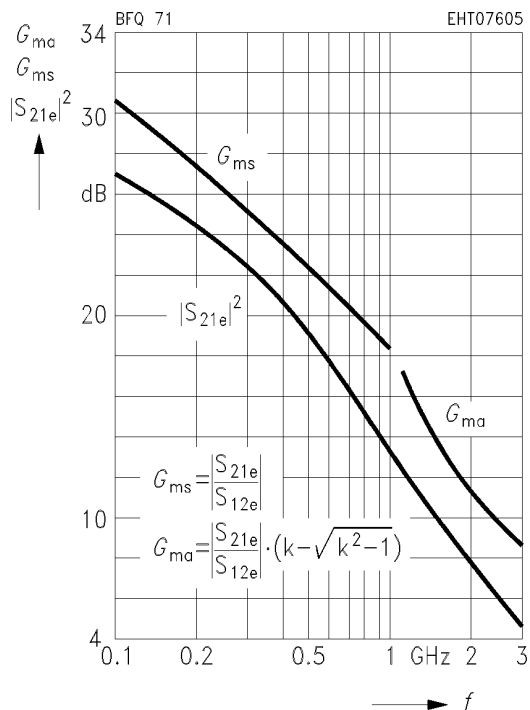

**Power gain  $G_{ma}$ ,  $G_{ms}$ ,  $|S_{21e}|^2 = f(f)$**   
 $I_C = 20 \text{ mA}$ ,  $V_{CE} = 6 \text{ V}$ ,  $Z_0 = 50 \Omega$

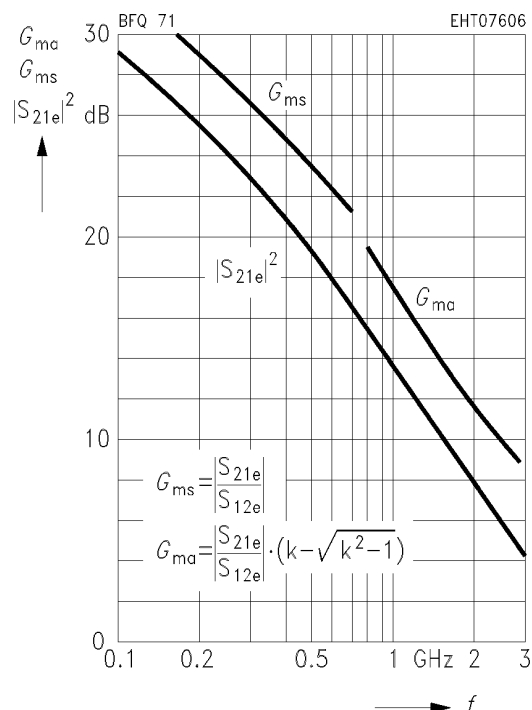



### Common Emitter S Parameters

<i>f</i>	<i>S</i> <sub>11</sub>		<i>S</i> <sub>21</sub>		<i>S</i> <sub>12</sub>		<i>S</i> <sub>22</sub>	
	GHZ	MAG	ANG	MAG	ANG	MAG	ANG	MAG

*I*<sub>C</sub> = 2 mA, *V*<sub>CE</sub> = 6 V, *Z*<sub>0</sub> = 50 Ω

0.1	0.90	- 19	6.93	166	0.025	78	0.98	- 8
0.2	0.87	- 37	6.45	152	0.048	68	0.94	- 16
0.3	0.81	- 55	5.85	140	0.068	59	0.88	- 23
0.4	0.77	- 71	5.41	129	0.082	51	0.82	- 28
0.6	0.69	- 97	4.41	112	0.101	40	0.73	- 36
0.8	0.64	- 118	3.64	98	0.112	33	0.65	- 41
1.0	0.61	- 134	3.06	87	0.118	28	0.60	- 45
1.2	0.59	- 147	2.64	79	0.121	25	0.57	- 49
1.5	0.57	- 163	2.19	66	0.125	22	0.54	- 54
1.8	0.57	- 176	1.87	56	0.129	20	0.52	- 60
2.0	0.58	176	1.70	49	0.131	20	0.51	- 65
2.5	0.59	159	1.41	34	0.138	20	0.49	- 78
3.0	0.60	145	1.21	21	0.150	19	0.48	- 92

*S*<sub>11</sub>, *S*<sub>22</sub> = *f* (*f*)

*I*<sub>C</sub> = 2 mA, *V*<sub>CE</sub> = 6 V, *Z*<sub>0</sub> = 50 Ω

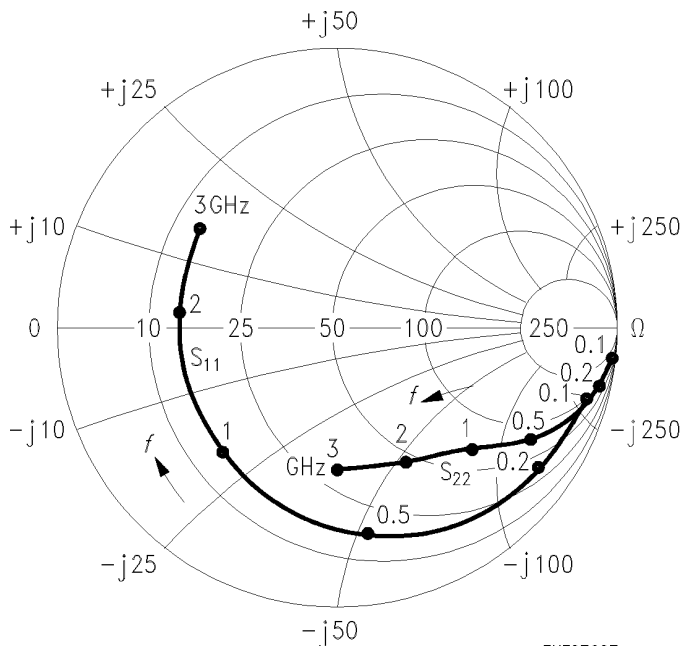

EHT07607

*S*<sub>12</sub>, *S*<sub>21</sub> = *f* (*f*)

*I*<sub>C</sub> = 2 mA, *V*<sub>CE</sub> = 6 V, *Z*<sub>0</sub> = 50 Ω

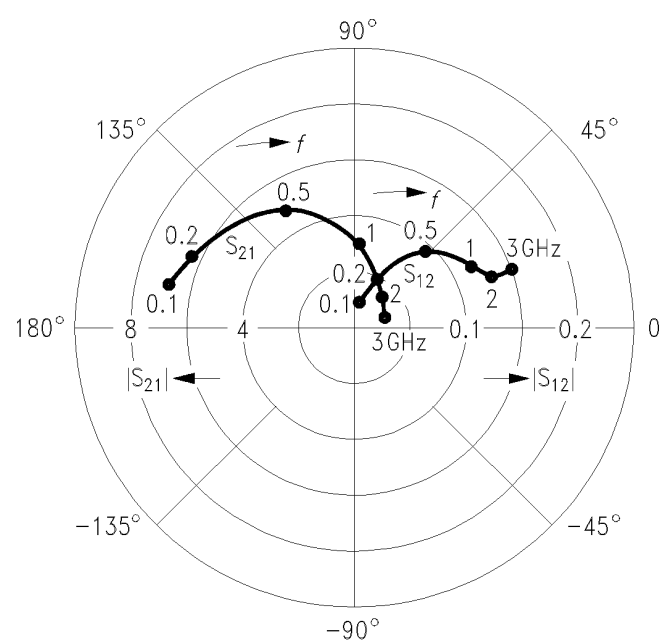

EHT07608

### Common Emitter S Parameters (continued)

<i>f</i>	<i>S</i> <sub>11</sub>		<i>S</i> <sub>21</sub>		<i>S</i> <sub>12</sub>		<i>S</i> <sub>22</sub>	
	MAG	ANG	MAG	ANG	MAG	ANG	MAG	ANG
0.1	0.79	- 31	14.23	160	0.023	76	0.95	- 14
0.2	0.73	- 59	12.37	151	0.040	61	0.84	- 26
0.3	0.66	- 83	10.36	127	0.053	51	0.73	- 33
0.4	0.62	- 102	8.88	115	0.060	45	0.65	- 38
0.6	0.57	- 128	6.56	100	0.071	40	0.53	- 43
0.8	0.55	- 146	5.12	89	0.077	37	0.47	- 46
1.0	0.54	- 160	4.17	80	0.083	37	0.43	- 48
1.2	0.54	- 170	3.55	73	0.089	37	0.40	- 51
1.5	0.54	178	2.89	63	0.099	37	0.38	- 55
1.8	0.54	168	2.43	54	0.110	37	0.37	- 61
2.0	0.56	162	2.20	48	0.117	36	0.36	- 65
2.5	0.57	148	1.81	35	0.137	35	0.34	- 78
3.0	0.59	136	1.55	23	0.158	32	0.34	- 92

*I*<sub>C</sub> = 5 mA, *V*<sub>CE</sub> = 6 V, *Z*<sub>0</sub> = 50 Ω

*S*<sub>11</sub>, *S*<sub>22</sub> = *f* (*f*)

*I*<sub>C</sub> = 5 mA, *V*<sub>CE</sub> = 6 V, *Z*<sub>0</sub> = 50 Ω

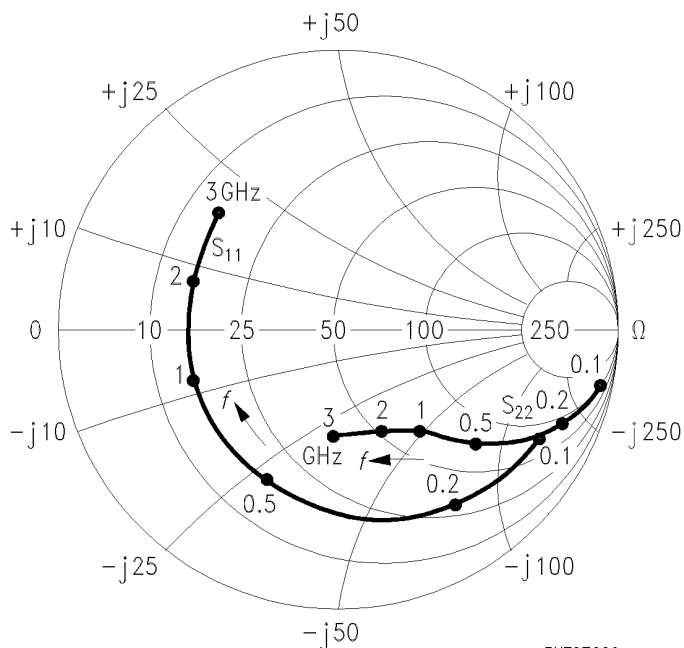

EHT07609

*S*<sub>12</sub>, *S*<sub>21</sub> = *f* (*f*)

*I*<sub>C</sub> = 5 mA, *V*<sub>CE</sub> = 6 V, *Z*<sub>0</sub> = 50 Ω

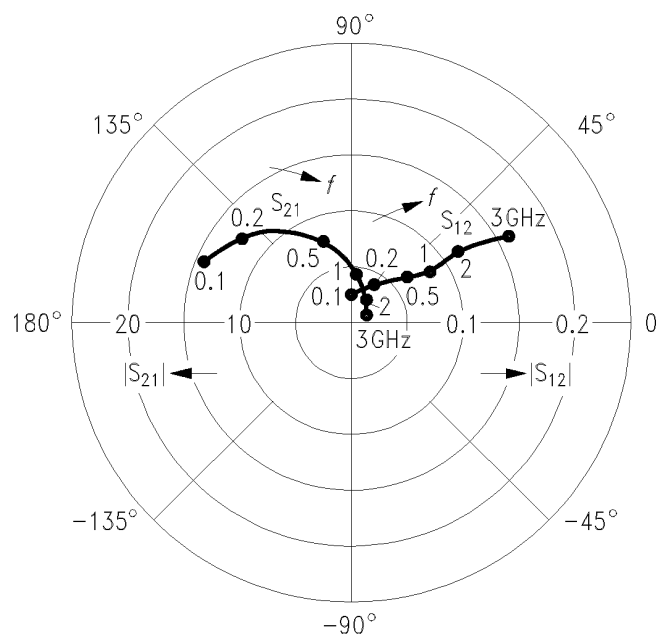

EHT07610

### Common Emitter S Parameters (continued)

<i>f</i>	<i>S</i> <sub>11</sub>		<i>S</i> <sub>21</sub>		<i>S</i> <sub>12</sub>		<i>S</i> <sub>22</sub>	
	MAG	ANG	MAG	ANG	MAG	ANG	MAG	ANG
0.1	0.68	- 47	22.06	152	0.020	70	0.90	- 20
0.2	0.60	- 85	17.31	130	0.032	56	0.73	- 33
0.3	0.55	- 111	13.39	116	0.040	49	0.59	- 39
0.4	0.55	- 128	10.84	106	0.045	46	0.51	- 42
0.6	0.53	- 150	7.60	93	0.053	46	0.41	- 44
0.8	0.53	- 164	5.80	83	0.061	46	0.37	- 46
1.0	0.53	- 174	4.67	76	0.069	47	0.34	- 47
1.2	0.53	178	3.95	70	0.078	48	0.32	- 49
1.5	0.53	168	3.19	60	0.091	48	0.31	- 53
1.8	0.54	160	2.67	52	0.106	47	0.31	- 59
2.0	0.56	155	2.42	47	0.114	46	0.30	- 63
2.5	0.58	143	1.99	34	0.138	43	0.28	- 76
3.0	0.60	132	1.69	23	0.163	38	0.28	- 91

*I*<sub>C</sub> = 10 mA, *V*<sub>CE</sub> = 6 V, *Z*<sub>0</sub> = 50 Ω

### *S*<sub>11</sub>, *S*<sub>22</sub> = *f* (*f*)

*I*<sub>C</sub> = 10 mA, *V*<sub>CE</sub> = 6 V, *Z*<sub>0</sub> = 50 Ω

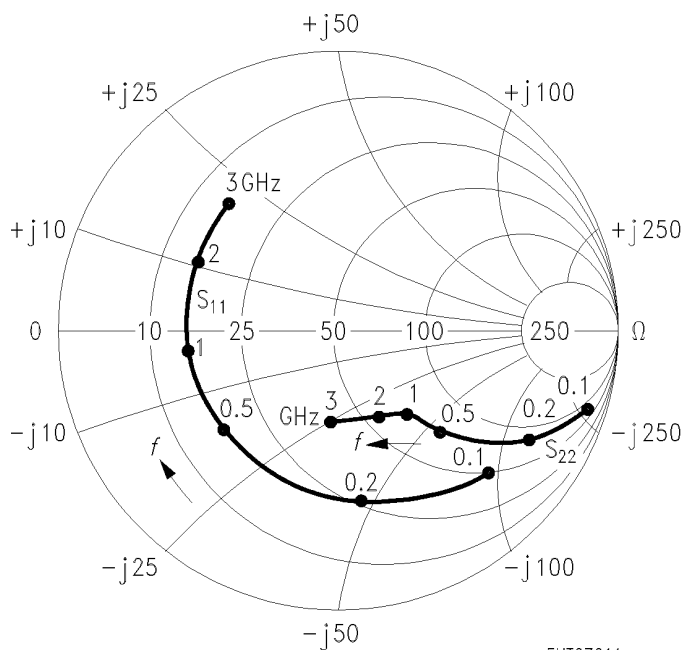

EHT07611

### *S*<sub>12</sub>, *S*<sub>21</sub> = *f* (*f*)

*I*<sub>C</sub> = 10 mA, *V*<sub>CE</sub> = 6 V, *Z*<sub>0</sub> = 50 Ω

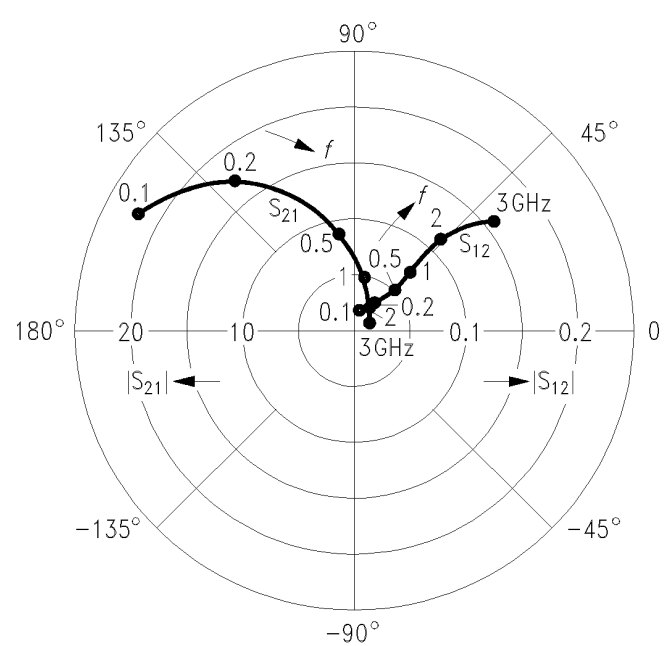

EHT07612

### Common Emitter S Parameters (continued)

<i>f</i>	<i>S</i> <sub>11</sub>		<i>S</i> <sub>21</sub>		<i>S</i> <sub>12</sub>		<i>S</i> <sub>22</sub>		
	GHZ	MAG	ANG	MAG	ANG	MAG	ANG	MAG	ANG
<i>I</i> <sub>C</sub> = 15 mA, <i>V</i> <sub>CE</sub> = 6 V, <i>Z</i> <sub>0</sub> = 50 Ω									
0.1	0.56	- 57	25.74	145	0.018	69	0.85	- 23	
0.2	0.47	- 96	18.17	122	0.028	58	0.65	- 32	
0.3	0.42	- 121	13.28	109	0.035	56	0.54	- 35	
0.4	0.42	- 137	10.48	100	0.042	57	0.47	- 35	
0.6	0.41	- 156	7.19	89	0.054	59	0.41	- 36	
0.8	0.40	- 168	5.46	81	0.068	60	0.39	- 37	
1.0	0.41	- 177	4.39	74	0.082	60	0.37	- 39	
1.2	0.41	176	3.71	68	0.096	60	0.36	- 41	
1.5	0.41	169	3.01	59	0.118	58	0.35	- 45	
1.8	0.43	161	2.53	52	0.142	56	0.35	- 52	
2.0	0.44	156	2.31	47	0.158	53	0.34	- 57	
2.5	0.46	147	1.91	35	0.204	47	0.33	- 70	
3.0	0.50	137	1.65	24	0.255	38	0.32	- 88	

### *S*<sub>11</sub>, *S*<sub>22</sub> = *f* (*f*)

*I*<sub>C</sub> = 15 mA, *V*<sub>CE</sub> = 6 V, *Z*<sub>0</sub> = 50 Ω

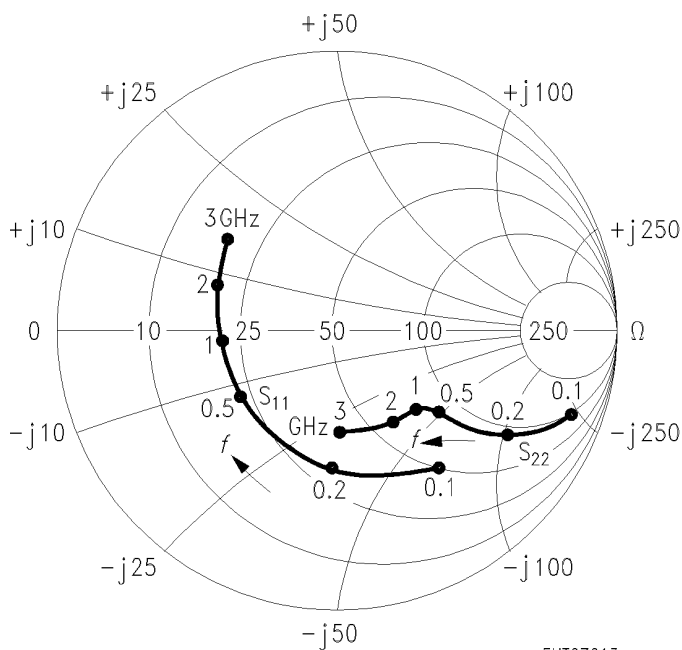

EHT07613

### *S*<sub>12</sub>, *S*<sub>21</sub> = *f* (*f*)

*I*<sub>C</sub> = 15 mA, *V*<sub>CE</sub> = 6 V, *Z*<sub>0</sub> = 50 Ω

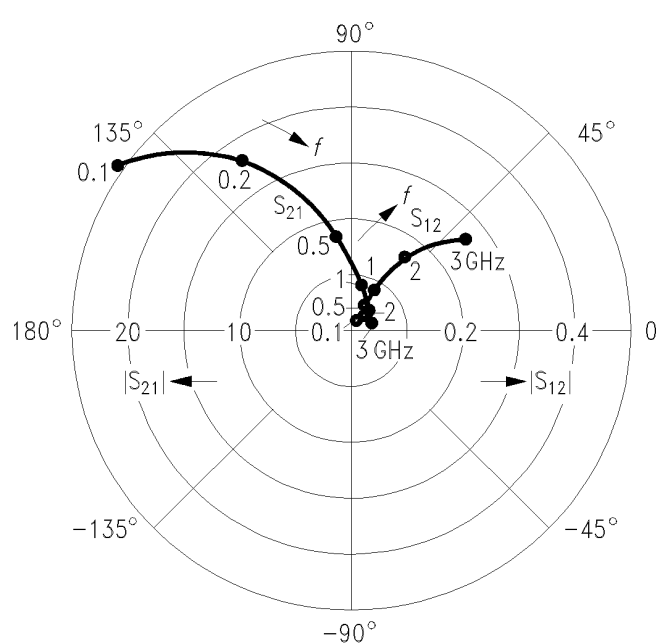

EHT07614

### Common Emitter S Parameters (continued)

<i>f</i>	<i>S</i> <sub>11</sub>		<i>S</i> <sub>21</sub>		<i>S</i> <sub>12</sub>		<i>S</i> <sub>22</sub>	
	MAG	ANG	MAG	ANG	MAG	ANG	MAG	ANG
GHz								
<i>I</i> <sub>C</sub> = 20 mA, <i>V</i> <sub>CE</sub> = 6 V, <i>Z</i> <sub>0</sub> = 50 Ω								
0.1	0.54	- 71	29.35	142	0.016	66	0.82	- 25
0.2	0.52	- 114	20.19	119	0.025	52	0.60	- 36
0.3	0.51	- 137	14.58	106	0.030	51	0.48	- 39
0.4	0.52	- 150	11.40	98	0.034	51	0.42	- 39
0.6	0.52	- 166	7.77	87	0.043	54	0.36	- 38
0.8	0.53	- 176	5.86	79	0.053	56	0.34	- 39
1.0	0.54	176	4.69	73	0.062	56	0.32	- 41
1.2	0.54	170	3.96	66	0.072	56	0.31	- 43
1.5	0.54	161	3.19	57	0.087	55	0.30	- 47
1.8	0.55	155	2.66	50	0.102	53	0.30	- 54
2.0	0.58	150	2.41	45	0.112	52	0.30	- 59
2.5	0.59	140	1.97	32	0.137	48	0.28	- 72
3.0	0.62	130	1.68	21	0.162	42	0.28	- 87

*S*<sub>11</sub>, *S*<sub>22</sub> = *f* (*f*)

*I*<sub>C</sub> = 20 mA, *V*<sub>CE</sub> = 6 V, *Z*<sub>0</sub> = 50 Ω

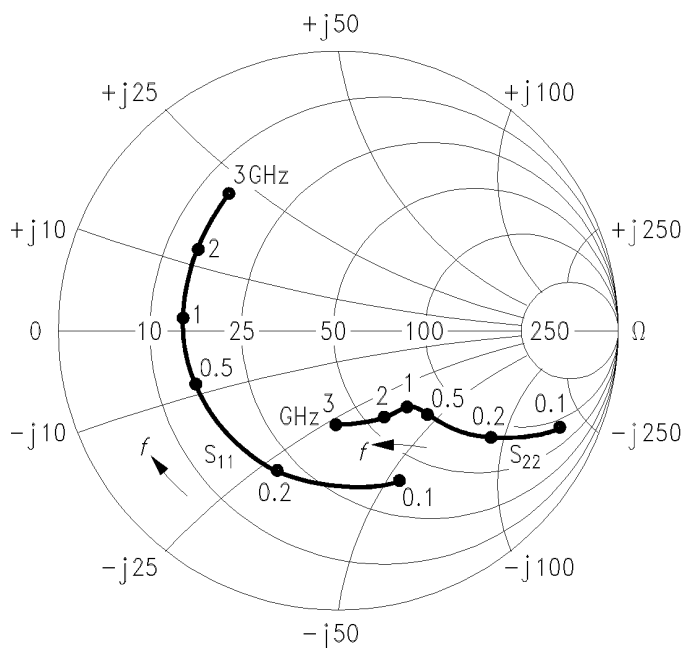

EHT07615

*S*<sub>12</sub>, *S*<sub>21</sub> = *f* (*f*)

*I*<sub>C</sub> = 20 mA, *V*<sub>CE</sub> = 6 V, *Z*<sub>0</sub> = 50 Ω

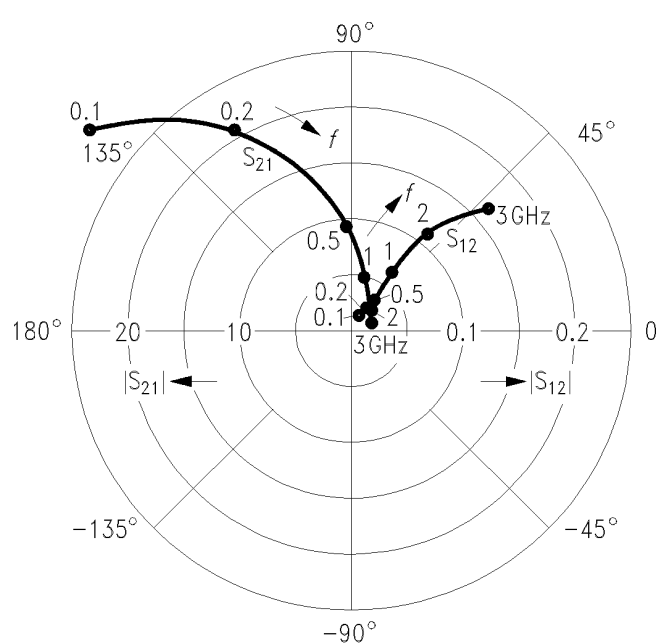

EHT07616

### Common Emitter S Parameters (continued)

<i>f</i>	<i>S</i> <sub>11</sub>		<i>S</i> <sub>21</sub>		<i>S</i> <sub>12</sub>		<i>S</i> <sub>22</sub>	
	MAG	ANG	MAG	ANG	MAG	ANG	MAG	ANG
0.1	0.91	- 17	7.02	166	0.021	78	0.98	- 7
0.2	0.87	- 36	6.57	153	0.042	69	0.95	- 14
0.3	0.82	- 53	5.98	141	0.060	60	0.90	- 20
0.4	0.78	- 69	5.01	130	0.073	53	0.84	- 25
0.6	0.70	- 94	4.54	113	0.090	42	0.75	- 33
0.8	0.64	- 115	3.76	100	0.100	35	0.69	- 38
1.0	0.60	- 132	3.17	89	0.106	30	0.64	- 41
1.2	0.58	- 145	2.74	80	0.109	27	0.61	- 45
1.5	0.56	- 161	2.28	68	0.113	24	0.58	- 50
1.8	0.56	- 174	1.94	57	0.118	23	0.56	- 55
2.0	0.57	177	1.77	51	0.120	23	0.55	- 60
2.5	0.58	160	1.47	36	0.127	23	0.53	- 72
3.0	0.59	146	1.26	22	0.140	23	0.52	- 85

*I*<sub>C</sub> = 2 mA, *V*<sub>CE</sub> = 10 V, *Z*<sub>0</sub> = 50 Ω

### *S*<sub>11</sub>, *S*<sub>22</sub> = *f* (*f*)

*I*<sub>C</sub> = 2 mA, *V*<sub>CE</sub> = 10 V, *Z*<sub>0</sub> = 50 Ω

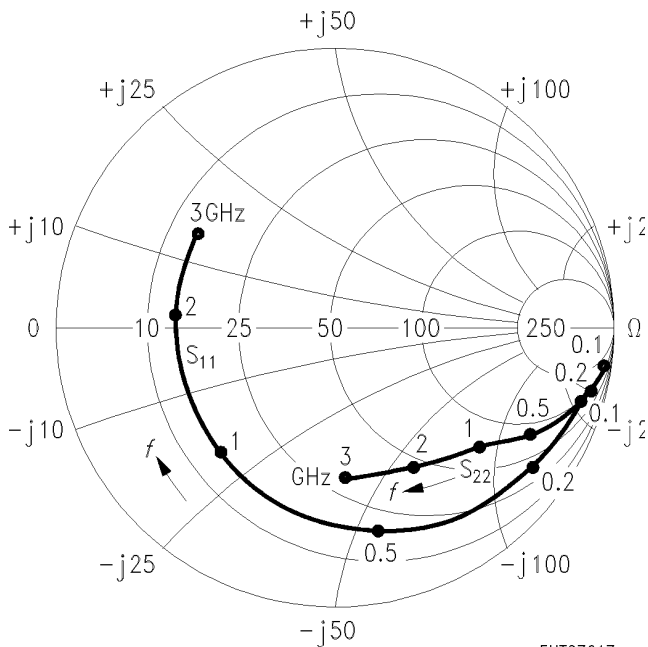

EHT07617

### *S*<sub>12</sub>, *S*<sub>21</sub> = *f* (*f*)

*I*<sub>C</sub> = 2 mA, *V*<sub>CE</sub> = 10 V, *Z*<sub>0</sub> = 50 Ω

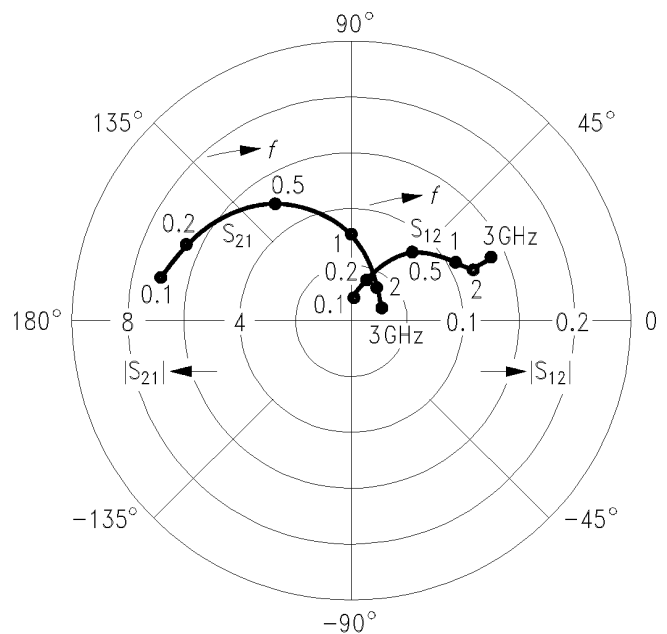

EHT07618

### Common Emitter S Parameters (continued)

<i>f</i>	<i>S</i> <sub>11</sub>		<i>S</i> <sub>21</sub>		<i>S</i> <sub>12</sub>		<i>S</i> <sub>22</sub>	
	MAG	ANG	MAG	ANG	MAG	ANG	MAG	ANG
0.1	0.80	- 28	14.24	160	0.020	71	0.95	- 13
0.2	0.73	- 57	12.50	142	0.036	61	0.86	- 23
0.3	0.67	- 79	10.55	128	0.047	53	0.76	- 29
0.4	0.63	- 98	9.10	117	0.055	47	0.68	- 34
0.6	0.57	- 125	6.78	101	0.064	41	0.58	- 38
0.8	0.54	- 143	5.31	90	0.071	39	0.52	- 41
1.0	0.53	- 157	4.33	81	0.076	38	0.48	- 43
1.2	0.52	- 168	3.69	74	0.082	38	0.46	- 45
1.5	0.52	180	3.00	63	0.091	39	0.44	- 49
1.8	0.53	170	2.52	54	0.101	39	0.43	- 55
2.0	0.54	163	2.29	49	0.108	39	0.42	- 59
2.5	0.56	150	1.89	36	0.127	38	0.40	- 70
3.0	0.58	137	1.61	23	0.148	35	0.40	- 84

*I*<sub>C</sub> = 5 mA, *V*<sub>CE</sub> = 10 V, *Z*<sub>0</sub> = 50 Ω

### *S*<sub>11</sub>, *S*<sub>22</sub> = *f* (*f*)

*I*<sub>C</sub> = 5 mA, *V*<sub>CE</sub> = 10 V, *Z*<sub>0</sub> = 50 Ω

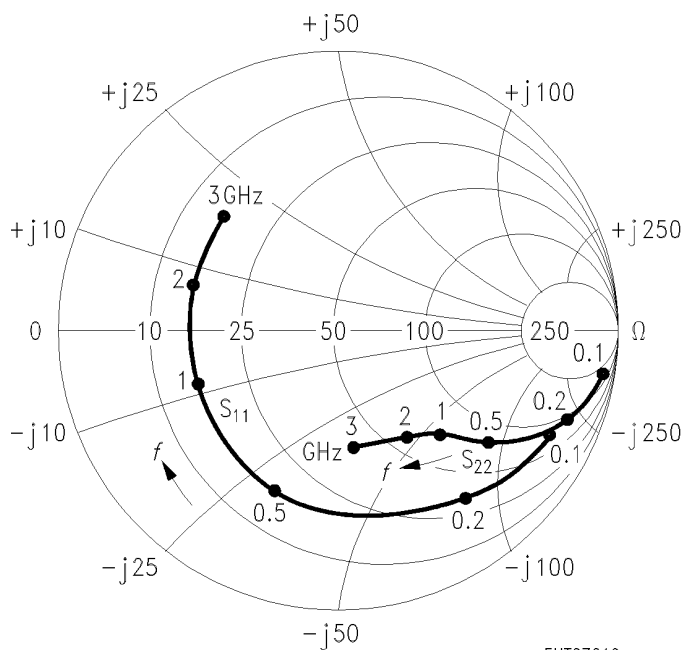

EHT07619

### *S*<sub>12</sub>, *S*<sub>21</sub> = *f* (*f*)

*I*<sub>C</sub> = 5 mA, *V*<sub>CE</sub> = 10 V, *Z*<sub>0</sub> = 50 Ω

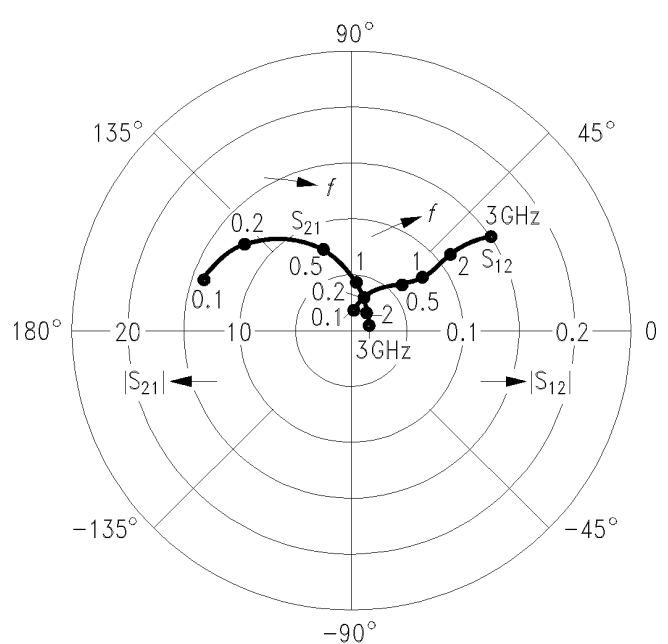

EHT07620

### Common Emitter S Parameters (continued)

<i>f</i>	<i>S</i> <sub>11</sub>		<i>S</i> <sub>21</sub>		<i>S</i> <sub>12</sub>		<i>S</i> <sub>22</sub>	
	MAG	ANG	MAG	ANG	MAG	ANG	MAG	ANG
0.1	0.68	- 43	21.82	153	0.018	71	0.91	- 17
0.2	0.60	- 78	17.39	131	0.030	58	0.76	- 29
0.3	0.56	- 105	13.60	117	0.037	50	0.64	- 34
0.4	0.54	- 123	11.10	107	0.042	47	0.56	- 36
0.6	0.51	- 146	7.83	94	0.050	46	0.47	- 38
0.8	0.51	- 161	5.99	84	0.057	47	0.43	- 39
1.0	0.51	- 171	4.83	77	0.064	48	0.41	- 41
1.2	0.51	180	4.08	70	0.072	49	0.39	- 43
1.5	0.51	170	3.30	61	0.084	49	0.38	- 48
1.8	0.52	162	2.77	53	0.098	48	0.38	- 52
2.0	0.54	156	2.51	48	0.106	47	0.37	- 56
2.5	0.56	145	2.06	35	0.129	45	0.35	- 67
3.0	0.58	134	1.75	23	0.152	40	0.35	- 81

*I*<sub>C</sub> = 10 mA, *V*<sub>CE</sub> = 10 V, *Z*<sub>0</sub> = 50 Ω

### *S*<sub>11</sub>, *S*<sub>22</sub> = *f* (*f*)

*I*<sub>C</sub> = 10 mA, *V*<sub>CE</sub> = 10 V, *Z*<sub>0</sub> = 50 Ω

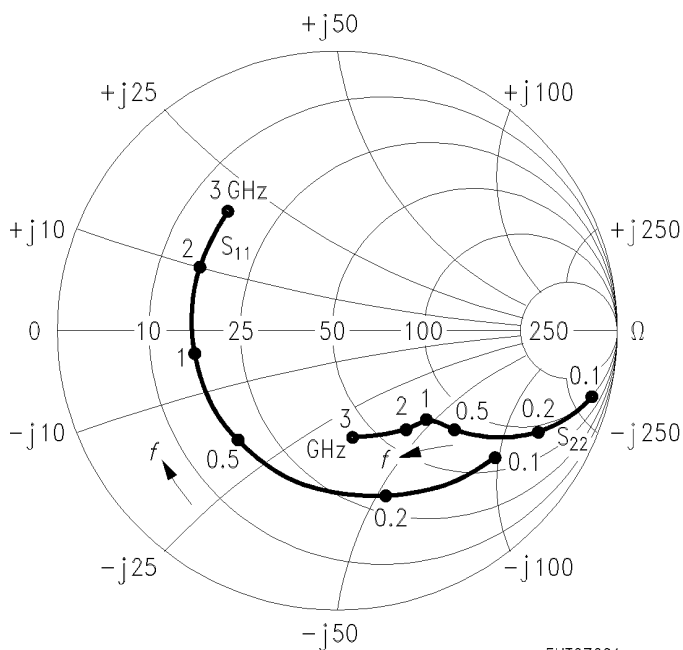

EHT07621

### *S*<sub>12</sub>, *S*<sub>21</sub> = *f* (*f*)

*I*<sub>C</sub> = 10 mA, *V*<sub>CE</sub> = 10 V, *Z*<sub>0</sub> = 50 Ω

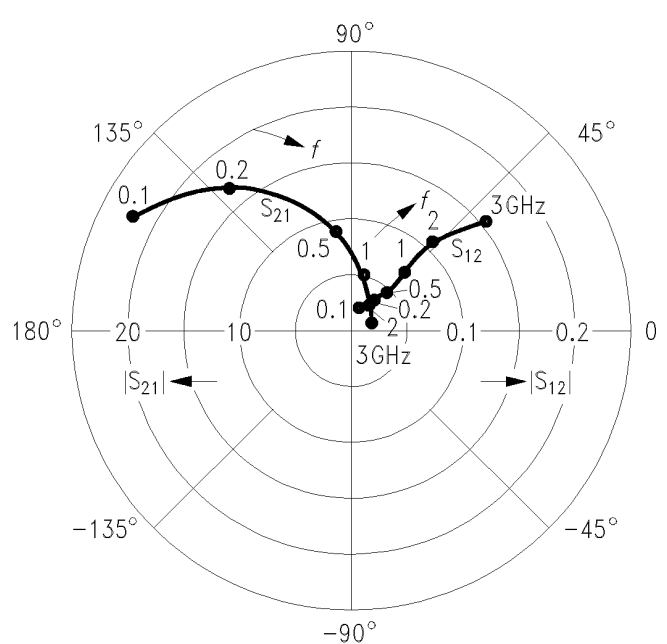

EHT07622



### Common Emitter S Parameters (continued)

<i>f</i>	<i>S</i> <sub>11</sub>		<i>S</i> <sub>21</sub>		<i>S</i> <sub>12</sub>		<i>S</i> <sub>22</sub>	
	MAG	ANG	MAG	ANG	MAG	ANG	MAG	ANG
0.1	0.62	- 55	26.35	148	0.017	69	0.88	- 20
0.2	0.55	- 94	19.54	125	0.026	55	0.69	- 31
0.3	0.52	- 119	14.64	112	0.031	50	0.57	- 34
0.4	0.51	- 136	11.66	102	0.036	50	0.50	- 35
0.6	0.50	- 156	8.06	90	0.044	51	0.44	- 35
0.8	0.50	- 169	6.12	82	0.052	52	0.41	- 36
1.0	0.51	- 178	4.91	75	0.061	53	0.39	- 38
1.2	0.51	175	4.15	68	0.069	54	0.38	- 40
1.5	0.51	166	3.35	59	0.082	53	0.37	- 44
1.8	0.53	158	2.80	51	0.097	52	0.37	- 50
2.0	0.54	153	2.53	47	0.106	51	0.36	- 54
2.5	0.57	143	2.07	34	0.129	48	0.34	- 65
3.0	0.59	132	1.77	23	0.153	43	0.34	- 80

*I*<sub>C</sub> = 15 mA, *V*<sub>CE</sub> = 10 V, *Z*<sub>0</sub> = 50 Ω

### *S*<sub>11</sub>, *S*<sub>22</sub> = *f* (*f*)

*I*<sub>C</sub> = 15 mA, *V*<sub>CE</sub> = 10 V, *Z*<sub>0</sub> = 50 Ω

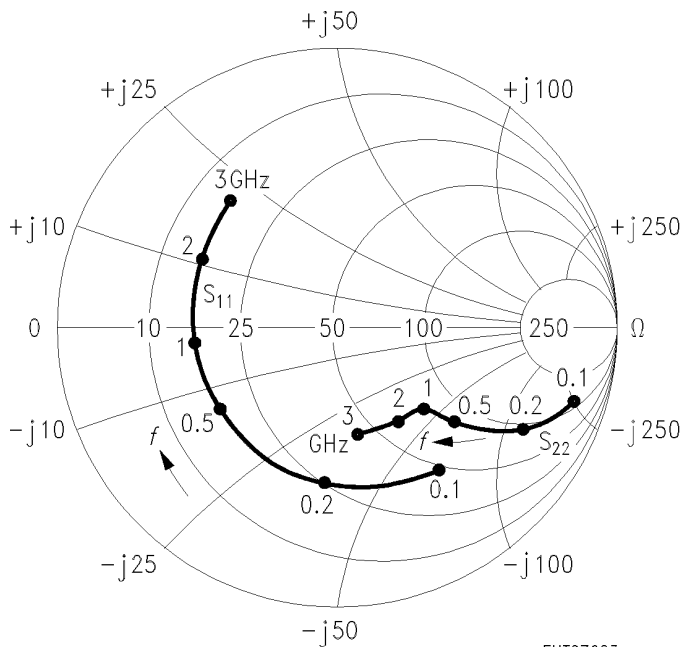

EHT07623

### *S*<sub>12</sub>, *S*<sub>21</sub> = *f* (*f*)

*I*<sub>C</sub> = 15 mA, *V*<sub>CE</sub> = 10 V, *Z*<sub>0</sub> = 50 Ω

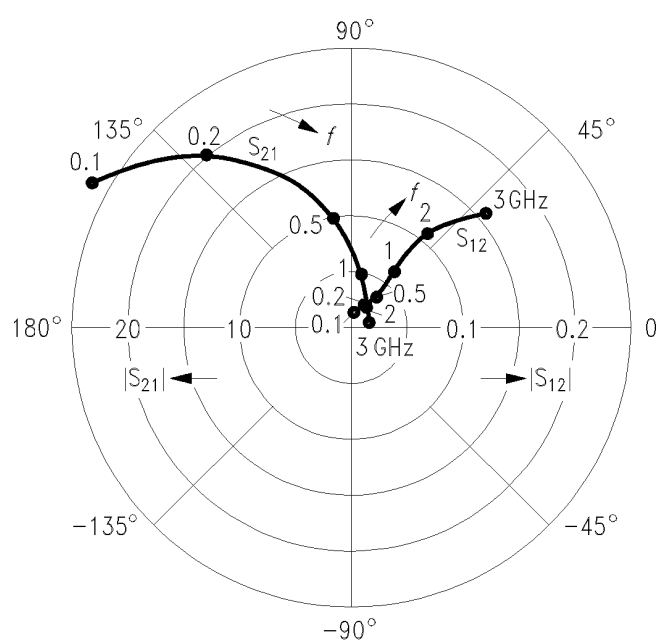

EHT07624

### Common Emitter S Parameters (continued)

<i>f</i>	<i>S</i> <sub>11</sub>		<i>S</i> <sub>21</sub>		<i>S</i> <sub>12</sub>		<i>S</i> <sub>22</sub>	
	MAG	ANG	MAG	ANG	MAG	ANG	MAG	ANG
GHz								
<i>I</i> <sub>C</sub> = 20 mA, <i>V</i> <sub>CE</sub> = 10 V, <i>Z</i> <sub>0</sub> = 50 Ω								
0.1	0.57	- 63	28.86	144	0.015	65	0.84	- 21
0.2	0.52	- 106	20.30	121	0.024	54	0.65	- 30
0.3	0.50	- 130	14.82	108	0.029	50	0.54	- 32
0.4	0.51	- 144	11.65	99	0.033	52	0.49	- 32
0.6	0.50	- 162	7.97	88	0.041	54	0.43	- 32
0.8	0.51	- 173	6.02	80	0.050	56	0.41	- 33
1.0	0.52	179	4.83	73	0.058	56	0.40	- 35
1.2	0.52	172	4.08	67	0.068	57	0.38	- 38
1.5	0.52	163	3.29	58	0.081	56	0.38	- 42
1.8	0.53	156	2.74	50	0.096	54	0.38	- 48
2.0	0.55	152	2.49	46	0.104	53	0.37	- 53
2.5	0.57	141	2.04	33	0.128	50	0.36	- 64
3.0	0.60	131	1.73	22	0.152	44	0.36	- 79

*S*<sub>11</sub>, *S*<sub>22</sub> = *f* (*f*)

*I*<sub>C</sub> = 20 mA, *V*<sub>CE</sub> = 10 V, *Z*<sub>0</sub> = 50 Ω

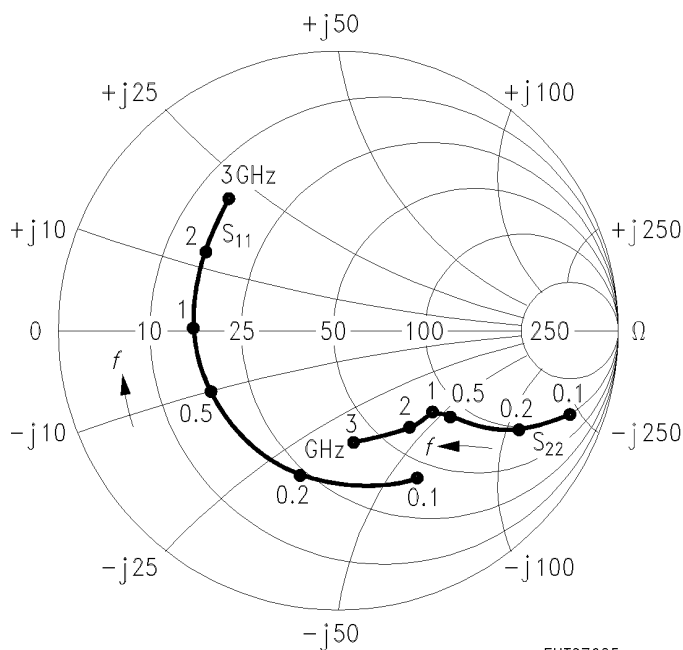

EHT07625

*S*<sub>12</sub>, *S*<sub>21</sub> = *f* (*f*)

*I*<sub>C</sub> = 20 mA, *V*<sub>CE</sub> = 10 V, *Z*<sub>0</sub> = 50 Ω

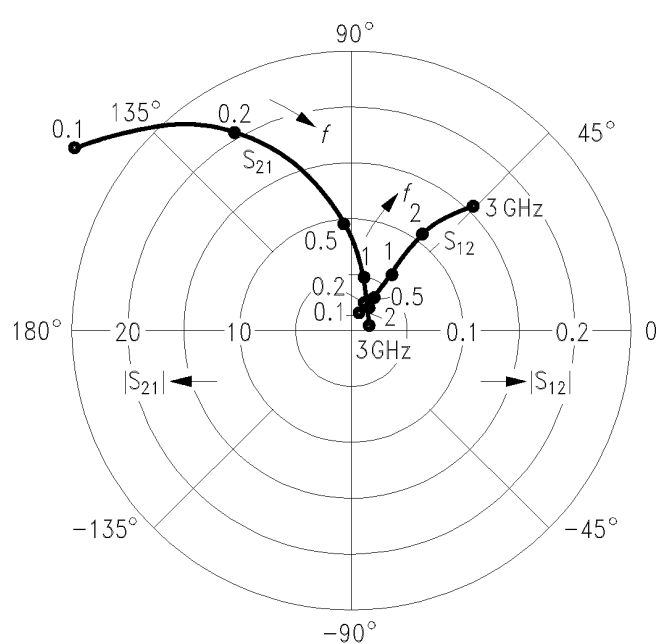

EHT07626