

Shielding and Guarding

How to Exclude Interference-Type Noise

What to Do and Why to Do It — A Rational Approach

by Alan Rich

This is the second of two articles dealing with interference noise. In the last issue of *Analog Dialogue* (Vol. 16, No. 3, pp. 16-19), we discussed the nature of interference, described the relationship between sources, coupling channels, and receivers, and considered means of combatting interference in systems by reducing or eliminating one of those three elements.

One of the means of reducing noise coupling is *shielding*. Our purpose in this article is to describe the correct uses of shielding to reduce noise. The major topics we will discuss include noise due to capacitive coupling, noise due to magnetic coupling, and driven shields and guards. A set of guidelines will be included, with do's and don'ts.

From the outset, it should be noted that shielding problems are always rational and do not involve the occult; but they are not always straightforward. Each problem must be analyzed carefully. It is important first to identify the noise source, the receiver, and the coupling medium. Improper shielding and grounding, based on faulty identification of any of these elements, may only make matters worse or create a new problem.

You can think of shielding as serving two purposes. First, shielding can be used to confine noise to a small region; this will prevent noise from extending its reach and getting into a nearby critical circuit. However, the problem with such shields is that noise captured by the shield can still cause problems if the return path the noise takes is not carefully planned and implemented by understanding of the ground system and making the connections correctly.

Second, if noise is present in a system, shields can be placed around critical circuits to prevent the noise from getting into sensitive portions of the circuits. These shields can consist of metal boxes around circuit regions or cables with shields around the center conductors. Again, where and how the shields are connected is important.

CAPACITIVELY COUPLED NOISE

If the noise results from an electric field, a shield works because a charge, Q_2 , resulting from an external potential, V_1 , cannot exist on the interior of a closed conducting surface (Figure 1).

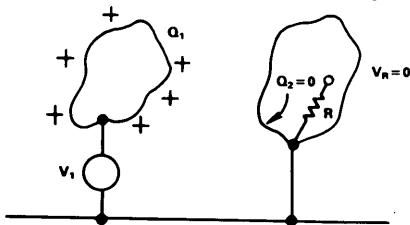

Figure 1. Charge Q_1 cannot create charge inside a closed metal shell.

Reprinted from *Analog Dialogue* 17-1 1983

Coupling by mutual, or stray, capacitance can be modeled by the circuit of Figure 2. Here, V_n is a noise source (switching transistor, TTL gate, etc.), C_s is the stray capacitance, Z is the impedance of a receiver (for example, a bypass resistor connected between the input of a high-gain amplifier and ground), and V_{no} is the output noise developed across Z .

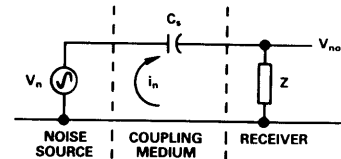

Figure 2. Equivalent circuit of capacitive coupling between a source and a nearby impedance.

A noise current, $i_n = V_n / (Z + Z_{Cs})$, will result, producing a noise voltage, $V_{no} = V_n / (1 + Z_{Cs}/Z)$. For example, if $C_s = 2.5$ pF, $Z = 10k\Omega$ (resistive), and $V_n = 100$ mV at 1.3 MHz, the output noise will be 20 mV (0.2% of 10V, i.e., 8 LSBs of 12 bits).

It is important to recognize the effect that very small amounts of stray capacitance will have on sensitive circuits. This becomes increasingly critical as systems are being designed to combine circuits operating at lower power (implying higher impedance levels), higher speed (implying lower nodal stray capacitance, faster edges, and higher frequencies), and higher resolution (much less output noise permitted).

When a shield is added, the change to the situation of Figure 2 is exemplified by the circuit model of Figure 3. With the assumption that the shield has zero impedance, the noise current in loop A-B-D-A will be V_n / Z_{Cs1} , but the noise current in loop D-B-C-D will be zero, since there is no driving source in that loop. And, since no current flows, there will be no voltage developed across Z . The sensitive circuit has thus been shielded from the noise source, V_n .

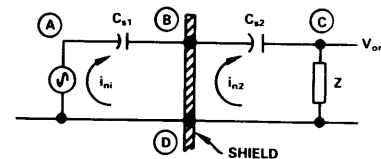

Figure 3. Equivalent circuit of the situation of Figure 2, with a shield interposed between the source and the impedance.

Guidelines for Applying Electrostatic Shields

- An electrostatic shield, to be effective, should be connected to the reference potential of any circuitry contained within the shield. If the signal is earthed or grounded (i.e., connected to a metal chassis or frame, and/or to earth), the shield must be earthed or grounded. But grounding the shield is useless if the signal is not grounded.

shield return. This, in turn, develops a shield voltage common to both the analog and digital shields. An equivalent circuit is shown in Figure 10, in which $V(t)$ is a 5-volt step from a TTL logic gate, R_{o2} is the 13-ohm output impedance of the logic gate, C_{ws} is the 470-pF capacitance from the shield to the center conductor of the shielded cable, and R_s and L_s are the 0.1-ohm resistance and 1-microhenry inductance of the 2-foot wire connecting the shield to the system ground.

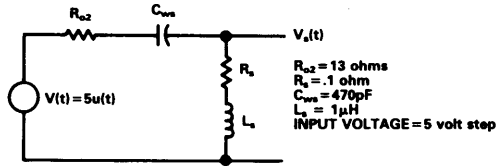

Figure 10. Equivalent circuit for generating shield voltage.

The shield voltage, $V_s(t)$, can be solved for by conventional circuit-analysis techniques, or simulated by actually building and carefully making measurements on a circuit with the given parameters. For the purpose of demonstration, the calculated response waveform, illustrated in Figure 11, with a 5-volt initial spike, resonant frequency of 7.3 MHz, and damping time constant of 0.15 μs , is sufficient to illustrate the nature of the voltage that appears on the shield and is capacitively coupled to the analog input. If the voltage is looked at with a wideband oscilloscope, it will look like a noise "spike." We can see that this transient will couple a fast damped waveform of significant peak amplitude to the analog system input.

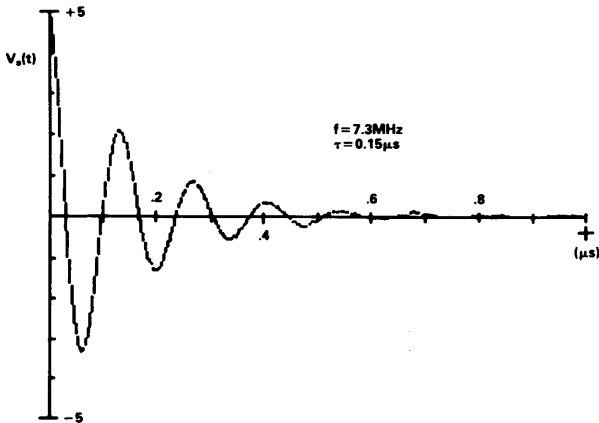

Figure 11. Computed response of circuit of Figure 10.

Even in a purely digital system, noise glitches can be caused to appear in apparently remote portions of a system having the kind of situation shown. This can often explain some otherwise inexplicable system bugs.

In quite a few cases, the proper choice of shield connection among the many possibilities may not be immediately obvious, and the guidelines may not provide us with a clear choice. There is no alternative but to analyze the various possibilities and choose the approach for which the lowest noise may be calculated.

For example, consider the case illustrated in Figure 12, in which the measurement system and the source have differing ground potentials. Should we connect the shield to A: the low side at the measurement-system input, B: ground at the system input, C: ground at the signal source, or D: the low side at the source?

A is a poor choice, since noise current is allowed to flow in a signal

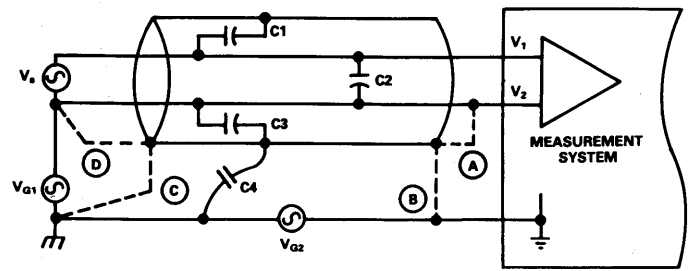

Figure 12. Possible grounds where system and source have differing ground potentials.

conductor. The path of the noise current due to V_{G1} , as it returns through C_4 , is shown in Figure 13a.

B is also a poor choice, since the two noise sources in series, V_{G1} and V_{G2} , produce a component across the two signal wires, developed by the source impedance in parallel with C_2 , in series with C_1 , as shown in Figure 13b.

C is poor, too, since V_{G1} produces a voltage across the two signal wires, by the same mechanism as (B), as Figure 13c shows.

D is the best choice, under the given assumptions, as can be seen in Figure 13d. It also tends to confirm the grounding guideline to connect the shield at the signal's reference potential.

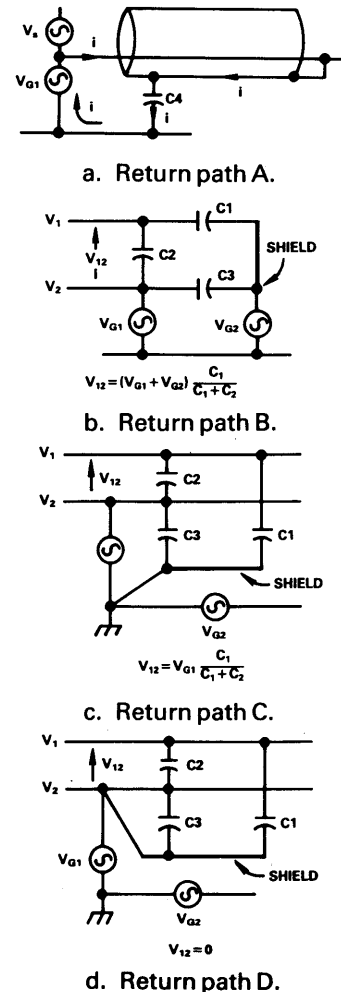

Figure 13. Equivalent circuits.

NOISE RESULTING FROM A MAGNETIC FIELD

Noise in the form of a magnetic field induces voltage in a conductor or circuit; it is much more difficult to shield against than elec-

●The shield conductor of a shielded cable should be connected to the reference potential at the signal-reference node (Figure 4).

●If the shield is split into sections, as might occur if connectors are used, the shield for each segment must be tied to those for the

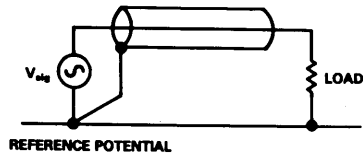

Figure 4. Grounding a cable shield.

adjoining segments, and ultimately connected (only) to the signal-reference node (Figure 5).

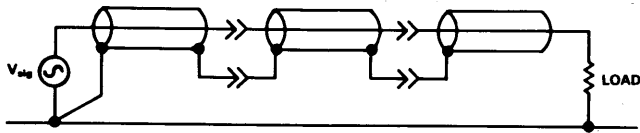

Figure 5. Shields must be interconnected if interrupted.

●The number of separate shields required in a system is equal to the number of independent signals that are being measured. Each signal should have its own shield, with no connections to other shields in the system, unless they share a common reference potential (signal "ground"). If there is more than one signal ground (Figure 6), each shield should be connected to its own reference potential.

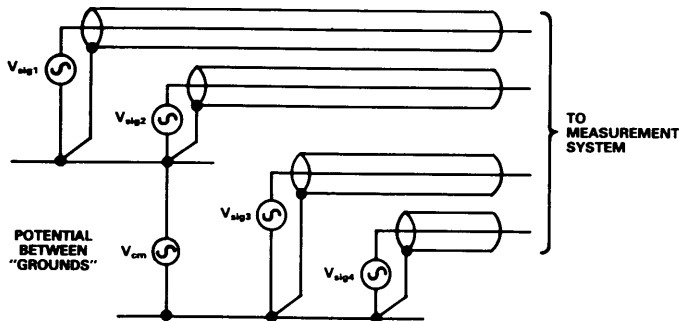

Figure 6. Each signal should have its own shield connected to its own reference potential.

●Don't connect both ends of the shield to "ground". The potential difference between the two "grounds" will cause a shield current to flow (Figure 7). The shield current will induce a noise voltage into the center conductor via magnetic coupling. An example of this can be found in Part 1 of this series, *Analog Dialogue* 16-3, page 18, Figure 10.

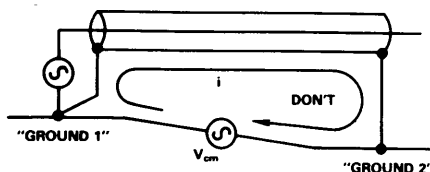
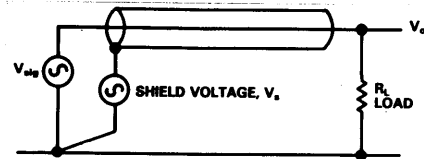

Figure 7. Don't connect the shield to ground at more than one point.

●Don't allow shield current to exist (except as noted later in this article). The shield current will induce a voltage in the center conductor.

●Don't allow the shield to be at a voltage with respect to the reference potential (except in the case of a guard shield, to be described). The shield voltage will couple capacitively to the center conductor (or conductors in a multiple-conductor shield). With

a noise voltage, V_s , on the shield, the situation is as shown in Figure 8.



a. Shield at potential V_s .

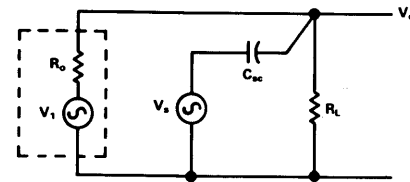

b. Equivalent circuit.

Figure 8. Don't permit the shield to be at a potential with respect to the signal.

The fraction of V_s appearing at the output will be

$$V_o = \frac{V_s}{\sqrt{1 + \frac{1}{(2\pi f R_{eq} C_{sc})^2}}} \quad (1)$$

where V_1 is the open-circuit signal voltage, R_o is the signal's source impedance, C_{sc} is the cable's shield-to-conductor capacitance, and R_{eq} is the equivalent parallel resistance of R_o and R_L . For example, if $V_s = 1V$ at 1.5MHz, $C_{sc} = 200pF$ (10 feet of cable), $R_o = 1000$ ohms, and $R_L = 10k\Omega$, the output noise voltage will be 0.86 volts. This is an often-ignored guideline; serious noise problems can be created by inadvertently applying undesired potentials to the shield.

●Know by careful study how the noise current that has been captured by the shield returns to "ground." An improperly returned shield can cause shield voltages, can couple into other circuits, or couple into other shields. The shield return should be as short as possible to minimize inductance.

Here is an example that illustrates the problems that can arise in relation to these last two guidelines: Consider the improperly configured shield system shown in Figure 9, in which a precision voltage source, V_1 , and a digital logic gate share a common shield connection. This situation can occur in a large system where analog and digital signals are cabled together.

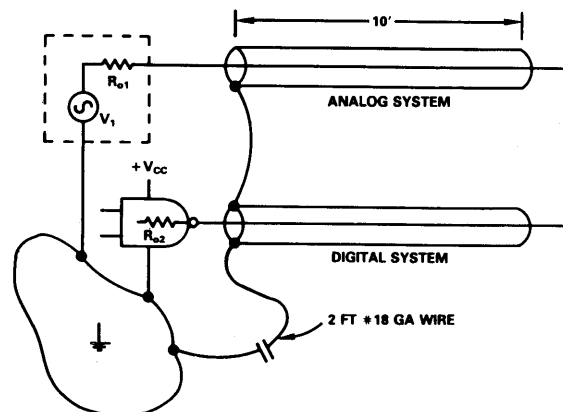

Figure 9. A situation that generates transient shield voltages.

A step voltage change in the output of the logic circuit couples capacitively to its shield, creating a current in the common 2-foot

tric fields because it can penetrate conducting materials. A typical shield placed around a conductor and grounded at one end has little if any effect on the magnetically induced voltage in that conductor.

As a magnetic field, B , penetrates a shield, its amplitude decreases exponentially (Figure 14). The skin depth, δ , of the shield material, is defined as the depth of penetration required for the field to be attenuated to 37% ($\exp(-1)$) of its value in free air. Table 1¹ lists typical values of δ for several materials at various frequencies. You can see that any of the materials will be more effective as a shield at high frequency, because δ decreases with frequency, and that steel provides at least an order of magnitude more effective shielding at any frequency than copper or aluminum.

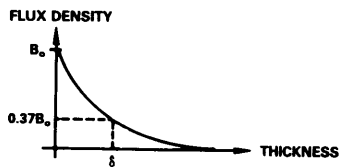

Figure 14. Magnetic field in a shield as a function of penetration depth.

Figure 15 compares absorption loss as a function of frequency for two thicknesses of copper and steel. 1/8-inch steel becomes quite effective for frequencies above 200 Hz, and even a 20-mil (0.5 mm) thickness of copper is effective at frequencies above 1 MHz. However, all show a glaring weakness at lower frequencies, including 50-60-Hz line frequencies—the principal source of magnetically coupled noise at low frequency.

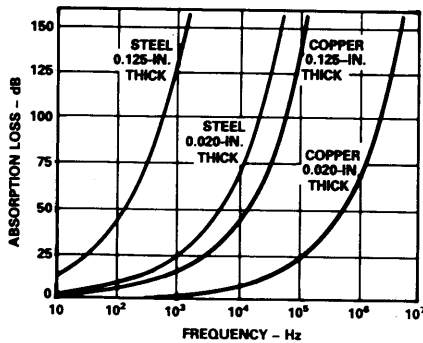

Figure 15. Absorption loss vs. frequency for two thicknesses of copper and steel.

For improved low-frequency magnetic shielding, a shield consisting of a high-permeability magnetic material (e.g., Mumetal)

Table 1. Skin depth, δ , vs. frequency

Frequency	δ for Copper		δ for Aluminum		δ for Steel	
	(in.)	(mm)	(in.)	(mm)	(in.)	(mm)
60Hz	0.335	8.5	0.429	10.9	0.034	0.86
100Hz	0.260	6.6	0.333	8.5	0.026	0.66
1kHz	0.082	2.1	0.105	2.7	0.008	0.2
10kHz	0.026	0.66	0.033	0.84	0.003	0.08
100kHz	0.008	0.2	0.011	0.3	0.0008	0.02
1MHz	0.003	0.08	0.003	0.08	0.0003	0.008

¹Table 1 and Figures 15 and 16 are from Ott, H.W., *Noise Reduction Techniques in Electronic Systems* (New York: John Wiley & Sons, © 1976).

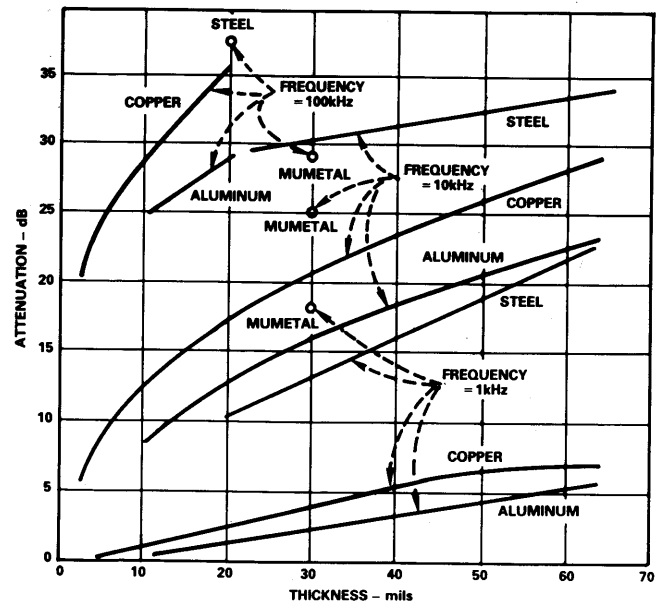
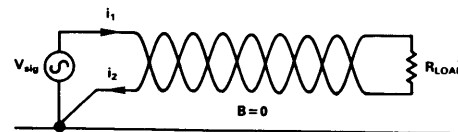

Figure 16. Shielding attenuation of Mumetal and other materials at several frequencies.

should be considered. Figure 16 compares a 30-mil thickness of Mumetal with various materials at several frequencies. It shows that, below 1 kHz, Mumetal is more effective than any of the other materials, while at 100kHz it is the least effective. However, Mumetal is not especially easy to apply, and if it is saturated by an excessively strong field, it will no longer provide an advantage.

As you can see, it is very difficult to shield against magnetic fields, i.e., to modify the coupling medium by shielding. Therefore, the most effective approaches at low frequency are to minimize the strength of the interfering magnetic field, minimize the receiver loop area, and minimize coupling by optimizing wiring geometries. Here are some guidelines:

- Locate the receiving circuits as far as possible from the source of the magnetic field.
- Avoid running wires parallel to the magnetic field; instead, cross the magnetic field at right angles.
- Shield the magnetic field with an appropriate material for the frequency and field strength.
- Use a twisted pair of wires for conductors carrying the high-level current that is the source of the magnetic field. If the currents in the two wires are equal and opposite, the net field in any direction



a. Correct connection with balanced currents.

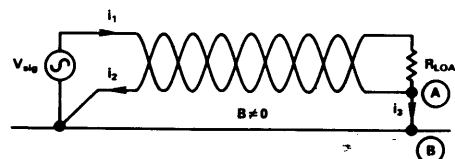

b. Incorrect connection forming ground loop.

Figure 17. Connections to a twisted pair.

over each cycle of twist will be zero (Figure 17a). For this arrangement to work, none of the current can be shared with another conductor, for example, a ground plane. Figure 17b shows what can happen if a ground loop is formed; if part of the current flows through the ground plane (depending on the ratio of conductor resistance to ground resistance), it will form a loop with the twisted pair, generating a field determined by $i_3 (= i_1 - i_2)$.

The ground connection between A and B need not be as simple as a short circuit to cause trouble. Any stray unbalanced capacitance or resistance from R_{load} circuits to the ground plane will also unbalance the currents and produce a net current through the wires and the ground plane, producing a ground loop and a related magnetic field. For this reason, it is also good practice to run the twisted pair close to the ground plane to tend to balance the capacitances from each side to ground, as well as to minimize loop area.

●Use a shielded cable with the high-level source circuit's return current carried in the shield (Figure 18). If the shield current, I_2 is equal and opposite to that in the center conductor, the center-conductor field and the shield field will cancel, producing a zero net field. In this case, which seems to violate the "no shield current" rule for receiver circuits, the concentric cable is not used to shield the center lead; instead, the geometry produces cancellation.

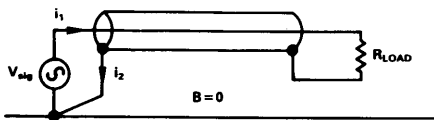

Figure 18. Use of shield for return current to noisy source.

This scheme can be usefully employed in an ATE system where accurate measurements must be performed on devices with high power-supply currents that may be noisy. For example, Figure 19 shows the application of this technique to the connections for the high-current logic supply for an a/d converter under test—at the end of a test cable.

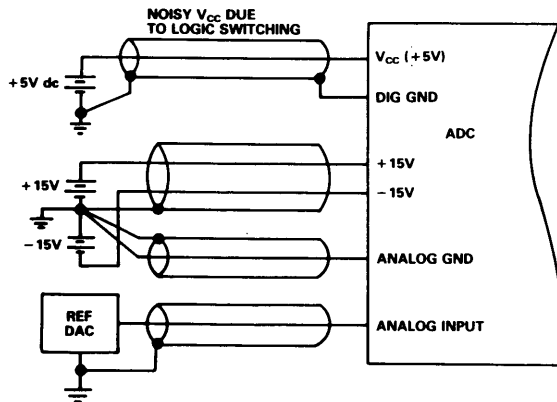

Figure 19. Application of circuit of Figure 18 in a test system.

●Since magnetically induced noise depends on the area of the receiver loop, the induced voltage due to magnetic coupling can be reduced by reducing the loop's area. What is the receiver loop? In the example shown in Figure 20, the signal source and its load are connected by a pair of conductors of length L and separation D . The circuit (assuming it has a rectangular configuration) forms a loop with area $D \cdot L$.

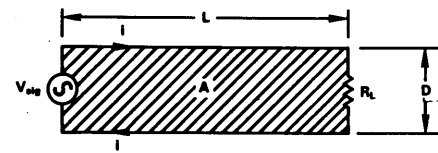

Figure 20. Area of a loop that receives magnetically coupled noise.

The voltage induced in series with the loop is proportional to the area and the cosine of its angle to the field. Thus, to minimize noise, the loop should be oriented at right angles to the field, and its area should be minimized.

The area can be reduced by decreasing the length of and/or decreasing the distance between the conductors. This is easily accomplished with a twisted pair, or at least a tightly cabled pair, of conductors. It is good practice to pair conductors so that the circuit wire and its return path will always be together. To do this, the designer must be certain of the actual path that the return current takes in getting back to the signal source. Quite often, the current returns by a path not intended in the original design layout.

If wires are moved (for example, by a technician troubleshooting some other problem), the loop area and orientation to the field may change, so that yesterday's acceptable noise level may be transformed to tomorrow's disastrous noise level. Which may lead to a service call . . . and another repetition of the cycle. The bottom line: Know the loop area and orientation, do what must be done to minimize noise—and *permanently secure the wiring!*

DRIVEN SHIELDS AND GUARDING

We have discussed the role of a current-driven shield carrying an equal and opposite current to reduce generated noise by reducing the magnetic field around a conductor.

Guarding is similar, in that it involves driving a shield, at low impedance, with a potential essentially equal to the common-mode voltage on the signal wire contained within the shield. Guarding has many useful purposes: It reduces common-mode capacitance, improves common-mode rejection, and eliminates leakage currents in high-impedance measurement circuits.

Figure 21 shows an example of an op amp with negligible bias current connected as a high-impedance non-inverting amplifier with gain. The purpose of the cable is to shield the high input-impedance signal conductor from capacitively coupled noise and to minimize leakage currents. The signal comes from a 10-megohm source, and the cable is assumed to have 1000 megohms of leakage resistance (which may change as a function of temperature, humidity, etc.) from conductor to shield. If connected as shown, the equivalent input circuit is an attenuator which loses 1% of the

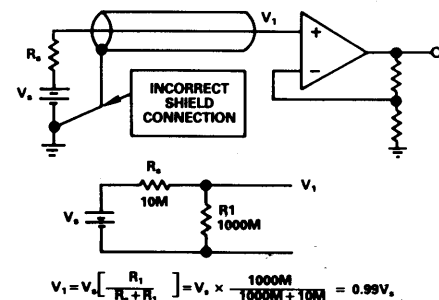

Figure 21. Op amp connected as high-impedance non-inverting amplifier with gain, with shielded input lead.

signal at the time it is measured, and an unknown fraction at other times. Also, the cable capacitance produces a substantial lag time constant, $R_s C_c$.

Figure 22 has the same players, but the shield is connected to the tap of the gain divider (usually at low impedance). Being connected to the inverting input of the op amp, it should be at the same potential as the amplifier's non-inverting input. Since there is no voltage across the cable's leakage resistance, there is no current through it and its resistance value doesn't matter; V_1 must therefore be equal to V_s , since bias current was assumed negligible.

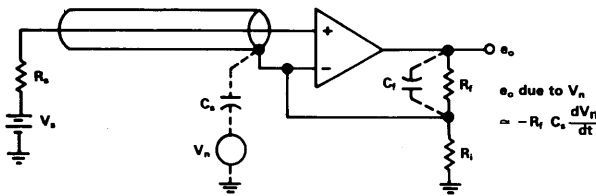
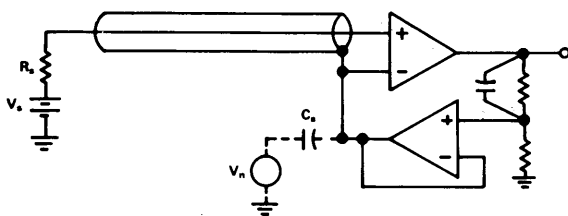

Figure 22. Same as Figure 21, but cable shield connected as a guard.

Also, there is no voltage across the cable capacitance, hence no charging or discharging of the cable; thus the lag time constant depends mainly on circuit strays and the amplifier's input capacitance. For stability, capacitance should be connected between the output and the negative input, such that $C_f R_F = C_s R_i$, where C_s is sum of the stray capacitance between shield and ground and the input capacitance.

There must be no noise voltage applied to the guard. In noisy systems, as Figure 22 shows, capacitively coupled noise will be differentiated, emphasizing the higher-frequency components. This can be avoided (Figure 23) by either using a buffer follower with fast response and low output impedance to drive the guard (a) or a second shield, around the guard, grounded to the signal common (b).



(a) Driven guard.

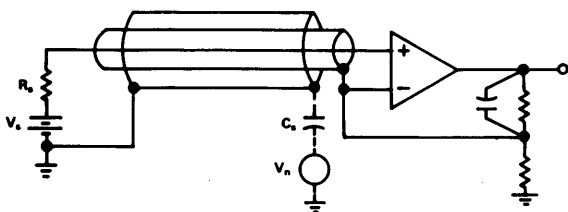

(b) Shielded guard.

Figure 23. Avoiding noise pickup on the guard.

In high-impedance current-input inverting configurations, where a length of shielded wire is used to guard the lead from the current source to the amplifier's inverting input, the guard should either be driven by a buffer at the same potential as the non-inverting input (and connected nowhere else), or be tied directly to the non-

inverting input, with a second outer shield connected to the signal's reference point.

SUMMARY

Table 2 summarizes the important points made in this article. All are important to maintaining a high-integrity shield system. However, we cannot emphasize too strongly the two subjects that are most-often ignored: appearance of noise voltage on signal shields and proper disposition of shield noise currents. *Noise voltage must not exist on the shield*; shield-to-conductor capacitance will couple the noise directly to the center conductor. *If shield currents are not returned properly, they can show up in a remote part of the system and perhaps cause trouble in a location totally unrelated to the shielding problem that was "solved."*

Table 2. Applicability of shielding considerations

Consideration	Universal	Electric	Magnetic
Know the noise source, coupling medium, and receiver.	X	X	X
Different shielding techniques are required for different noise sources, coupling channels, and receivers.	X	X	X
In most situations, conventional circuit analysis using lumped elements can be used.	X	X	X
Connect the shield at the signal-source end only.		X	
Carry shields through connectors.		X	
Individual shields should not be tied together.		X	
Do not ground both ends of a shield.		X	
Do not allow shield current to flow, except for driven shields - to cancel magnetic fields		X	X
Do not allow voltage on a shield, except for guarding.		X	
Know exactly where noise current from the shield will flow.		X	
Use short connections to return noise current from the shield.		X	
Electrostatic shields have little effect in reducing noise resulting from magnetic fields.			X
Reduce magnetic fields by physical separation proper orientation, twisted pairs, and/or driven shields.			X
Know the receiver loop area and orientation to the field. Keep field at right angles and reduce the loop area by using paired conductors, preferably twisted pairs, and minimize wire lengths.			X
Use guarding in high-impedance circuits	X	X	
In high-impedance circuits, be extremely careful of shield noise	X	X	

BRIEF BIBLIOGRAPHY

For further reading, see:

Brokaw, A. Paul. "Analog Signal Handling for High Speed and Accuracy," *Analog Dialogue* 11-2, 1977, pp. 10-16.

Brokaw, A. Paul. "An I.C. Amplifier Users' Guide to Decoupling, Grounding, and Making Things Go Right for a Change," *Analog Devices Data-Acquisition Databook* 1982, Volume I, Pages 21-13 to 21-20.

Morrison, Ralph. *Grounding and Shielding Techniques in Instrumentation* Second Edition. (New York: John Wiley & Sons, 1977).

Ott, Henry W. *Noise Reduction Technique in Electronic Systems*. (New York: John Wiley & Sons, 1976).