



## 1.5A SmartOR™ Dual Regulator with V<sub>AUX</sub> Drive

### Features

- Automatic selection of V<sub>CC</sub> or V<sub>SBY</sub>
- Drive control signal for external V<sub>AUX</sub> switch
- Continuous 3.3V output supply
- Glitch-free output during supply transitions
- Built-in hysteresis for supply selection
- V<sub>CC</sub> regulates up to 1.5A output current
- V<sub>SBY</sub> regulates up to 375mA output current
- Foldback current limiting
- Thermal shutdown with hysteresis
- On-chip controller operates from V<sub>CC</sub>, V<sub>SBY</sub> or V<sub>OUT</sub>

### Applications

- Peripheral Component Interface (PCI) Adapter Cards
- Network Interface Cards (NIC's)
- Multiple Powered Systems
- Systems with Standby Capabilities

### Product Description

The California Micro Devices' SmartOR™ CMPWR280 is a fully protected Dual-Input low dropout CMOS regulator that also provides the necessary control signal for driving an external auxiliary Pchannel MOSFET switch. The SmartOR™ device automatically selects one of three possible inputs on a priority basis: V<sub>CC</sub> (1.5A), V<sub>SBY</sub> (375mA) or V<sub>AUX</sub> via the drive signal used to control an external switch.

V<sub>CC</sub> is given first priority. In the event of the V<sub>CC</sub> supply being powered down, the device will automatically deselect the V<sub>CC</sub> prior to regulator dropout and immediately select V<sub>SBY</sub> (second priority) as its power source.

If neither V<sub>CC</sub> nor V<sub>SBY</sub> are present the drive control output will turn-on an external P-channel MOSFET switch from an auxiliary 3.3V supply V<sub>AUX</sub> to V<sub>OUT</sub>.

All the necessary control circuitry needed to provide a smooth and automatic transition between all three supplies has been incorporated. This allows V<sub>CC</sub> to be dynamically switched without loss of output voltage.

The CMPWR280 is internally protected against output short-circuits, current overload and thermal overload.

### Pin Diagram

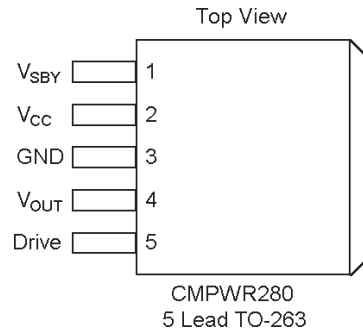

### Typical Application Circuit

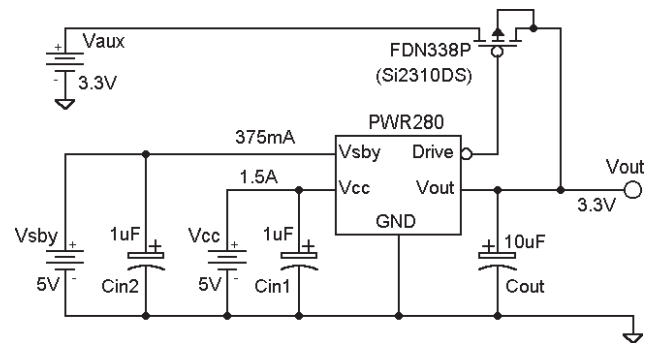

### Simplified Electrical Schematic

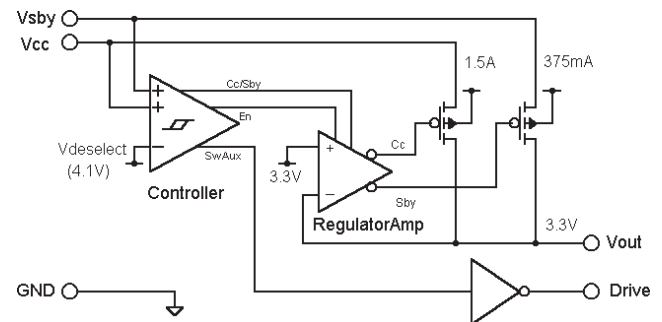

### STANDARD PART ORDERING INFORMATION

Package		Ordering Part Number
Pins	Style	Part Marking
5	TO263	CMPWR280TO

When placing an order please specify desired shipping: Tubes or Tape & Reel.



ABSOLUTE MAXIMUM RATINGS		
Parameter	Rating	Unit
ESD Protection (HBM)	2000	V
$V_{CC}$ , $V_{SBY}$ , $V_{OUT}$	+6.0, Gnd -0.5	V
Drive Logic Voltage	$V_{CC}$ ( $V_{SBY}$ ) +0.5, GND -0.5	V
Storage Temperature Range	-40 to +150	
Operating Ambient	0 to +70	°C
Operating Junction	0 to +150	
Power Dissipation: (TO-263) <sup>Note 1</sup>	Internally Limited	W

OPERATING CONDITIONS		
Parameter	Range	Unit
$V_{CC}$ , $V_{SBY}$	5.0 ± 0.25	V
Temperature (Ambient)	0 to +70	°C
Load Current	0 to 1500	mA
$C_{EXT}$	10 ± 10%	µF

ELECTRICAL OPERATING CHARACTERISTICS (over operating conditions unless specified otherwise)						
Symbol	Parameter	Conditions	MIN	TYP	MAX	UNIT
$V_{OUT}$	Regulator Output Voltage	0mA < $I_{LOAD}$ < 1500mA ( $V_{CC}$ ) 0mA < $I_{LOAD}$ < 375mA ( $V_{SBY}$ )	3.135	3.30	3.465	V
$V_{CCSEL}$	Select Voltage	$V_{CC}$ Regulator Enabled		4.50	4.70	
$V_{CCDES}$	$V_{CC}$ Deselect Voltage	$V_{CC}$ Regulator Disabled	3.90	4.10		V
$V_{CCHYST}$	Hysteresis Voltage	$V_{CC}$ Hysteresis: <sup>Note 2</sup>		0.40		
$I_{OUT}$	Maximum Output Current	$V_{CC}$ selected $V_{SBY}$ selected	1500 375	2500 750		mA
$I_{SC}$	Short Circuit Output Current	$V_{CC}$ selected $V_{SBY}$ selected		800 200		mA
$I_{ROCC}$	$V_{CC}$ Pin Reverse Leakage	$V_{CC} = 0V$ , $V_{SBY} = 5V$		10	100	µA
$I_{RSBY}$	$V_{SBY}$ Pin Reverse Leakage	$V_{SBY} = 0V$ , $V_{CC} = 5V$		10	10	
$V_{RLOAD}$	$V_{CC}$ Load Regulation $V_{SBY}$ Load Regulation	$V_{CC}$ selected, $I_{LOAD} = 15mA$ to 1500mA $V_{SBY}$ selected, $I_{LOAD} = 5mA$ to 375mA		30 30		mV
$V_{RLINE}$	Line Regulation	$V_{CC} = 4.5V$ to 5.5V, $I_{LOAD} = 5mA$		5		mV
$I_{CC}$	$V_{CC}$ Supply Current	$V_{CC}$ selected, $I_{OUT} = 0mA$ $V_{CCDES} > V_{CC} > V_{AUX}$ or $V_{OUT}$		1.5 0.1	3.0 0.2	mA
$I_{SBY}$	$V_{SBY}$ Supply Current	$V_{SBY}$ selected, $I_{OUT} = 0mA$		1.5	3.0	mA
$I_{GND}$	Ground Current: <sup>Note 3</sup>	Regulator Disabled (only $V_{OUT}$ present) Regulator selected, $I_{LOAD} = 5mA$ Regulator selected = 5V, $I_{LOAD} = 500mA$		0.2 1.5 1.8	0.3 3.0 3.5	mA
$R_{OH}$	Drive $R_{DS}$ High	$R_{DS}$ to $V_{CC}$ , $V_{CC} > V_{CCSEL}$		5	10	kΩ
$R_{OH}$	Drive $R_{DS}$ Low	$R_{DS}$ to GND, $V_{CCDES} > V_{CC}$		0.5	1	
$t_{DH}$	Drive High Delay	$C_{DRIVE} = 1nF$ , $V_{CC}$ $t_{RISE} < 100ns$		5.0		µs
$t_{DL}$	Drive Low Delay	$C_{DRIVE} = 1nF$ , $V_{CC}$ $t_{FALL} < 100ns$		0.5		
$T_{DISABLE}$	Shutdown temperature			165		°C
$T_{HYST}$	Thermal hysteresis			30		

Note 1: The maximum power dissipation of this device is internally limited by thermal shutdown circuitry. To achieve a power dissipation of 3.0 watts, a case-to-ambient thermal resistance of 25°C/W must be provided. This will typically require dedicated heatsinking ability of the printed circuit board. For more details, please see the Typical Thermal Characteristics section.

Note 2: The hysteresis defines the maximum level of acceptable disturbance on  $V_{CC}$  during switching. It is recommended that the  $V_{CC}$  source impedance be kept below 0.15Ω to ensure the switching disturbance remains below the hysteresis during select/deselect transitions.

Note 3: Ground pin current consists of controller current (0.2mA) and regulator current when selected



## Interface Signals

$V_{CC}$  is the primary 5V power supply for the internal regulator. Whenever  $V_{CC}$  exceeds  $V_{CCSEL}$  (4.5V), the internal regulator (1500mA) will be enabled and deliver a fixed 3.3V at  $V_{OUT}$ . When  $V_{CC}$  falls below  $V_{CCDES}$  (4.1V typically) the regulator will be disabled.

Internal loading on this pin is typically 1.5mA when the regulator is enabled, which reduces to 0.2mA whenever the regulator is disabled. If  $V_{CC}$  falls below either the  $V_{SBY}$  or  $V_{OUT}$  voltage, the loading on  $V_{CC}$  will reduce to only a few microamperes.

During a  $V_{CC}$  power up sequence, there will be an effective step increase in  $V_{CC}$  line current when the regulator is enabled. The amplitude of this step increase will depend on the dc load current and any current required for charging/discharging the load capacitance. This line current transient will cause a voltage disturbance at the  $V_{CC}$  pin proportional to the effective power supply source impedance being delivered to the  $V_{CC}$  input.

To prevent chatter during Select and Deselect transitions, a built-in hysteresis voltage of 400mV has been incorporated. It is recommended that the power supply connected to the  $V_{CC}$  input should have a source impedance of less than  $0.15\Omega$  to minimize the chatter during the enabling/disabling of the regulator.

$V_{SBY}$  is the standby 5V supply power source, which is only selected on when  $V_{CC} < V_{CCDES}$ . If  $V_{SBY}$  is selected, the regulator can deliver a maximum of 375mA load current. Whenever  $V_{SBY}$  exceeds both  $V_{CC}$  and  $V_{OUT}$ , it will be used to provide all the internal bias currents and any necessary regulator current.

**GND** is the reference for all voltages. The current that flows in the ground connection is very low (typically 2.0mA) and has minimal variation over all load conditions

$V_{OUT}$  is the regulator output voltage connection used to power the load. An output capacitor of ten microfarads is used to provide the necessary phase compensation, thereby preventing oscillation. This capacitor also helps to minimize the peak output disturbance during power supply changeover.

When both  $V_{CC}$  and  $V_{SBY}$  fall below  $V_{OUT}$ ,  $V_{OUT}$  will be used to provide the necessary quiescent current for the internal reference circuits. This ensures excellent start-up characteristics for the regulator.

**Drive** is an active LOW logic output intended to be used as the control signal for driving an external P-channel MOSFET switch whenever the regulator is disabled. This will allow the voltage at  $V_{OUT}$  to be powered from an auxiliary supply voltage (3.3V).

The Drive pin is pulled HIGH to  $V_{CC}$  whenever the regulator is enabled, thus ensuring that the auxiliary supply remains isolated during normal regulator operation.

Pin Functions	
Symbol	Description
$V_{SBY}$	Standby Positive 5V Supply input. Used to power internal regulator (375mA) when $V_{CC}$ is not available.
$V_{CC}$	Main Positive 5V Supply input. Powers the internal regulator (1.5A) whenever $V_{CC}$ exceeds the select threshold (typically 4.5V)
GND	Ground Reference for all voltages.
$V_{OUT}$	Regulator output voltage (3.3V).
Drive	Logic signal for controlling external auxiliary switch. Active LOW output whenever the internal regulator is disabled.



Typical DC Characteristics

Unless stated otherwise, all DC characteristics were measured at room temperature with a nominal V<sub>CC</sub> supply voltage of 5.0 volts and an output capacitance of 10μF.

Fig 1.1. V<sub>CC</sub> Line regulation

is measured while forcing the deselect threshold to an artificial low level for loads of 100mA, 500mA and 1.5A. At the maximum rated load of 1.5A, a drop in line regulation occurs when the V<sub>CC</sub> supply voltage drops below 3.8V. For light load conditions (100mA), regulation is maintained as low as 3.2V.

Fig 1.1. Line Regulation

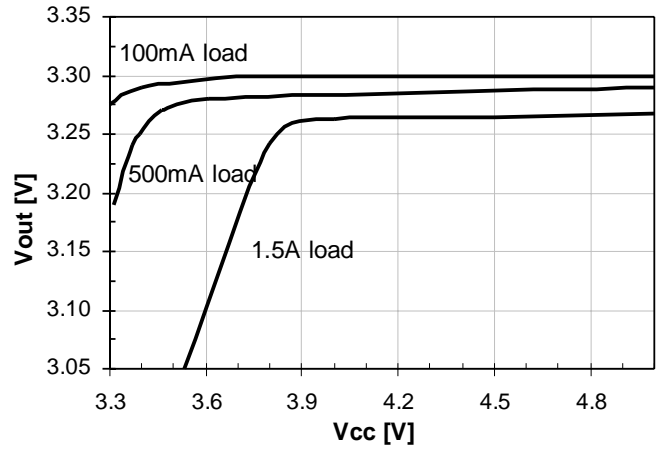

Fig 1.2. V<sub>CC</sub> Load regulation (pulse condition)

performance is shown up to and beyond the rated load. A change in load from 10% to 100% of rated current (150mA to 1500mA) results in an output voltage change of about 20mV. This translates into an effective output impedance of less than 15mΩ.

Fig 1.2. V<sub>CC</sub> Load Regulation (pulse condition)

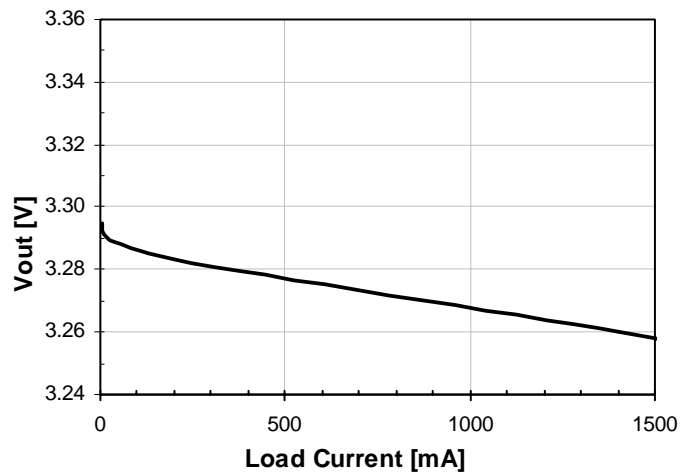
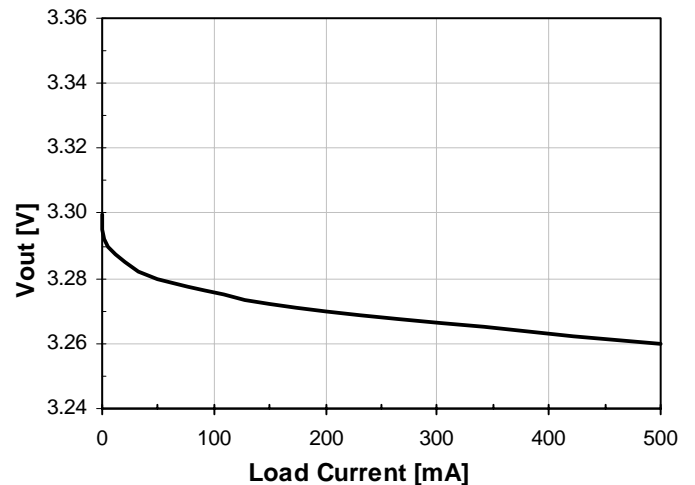

Fig 1.3. V<sub>SBY</sub> Load regulation (pulse condition)

performance is shown up to and beyond the rated load. A change in load from 10% to 100% of rated (50mA to 500mA) results in an output voltage change of about 20mV. This translates into an effective output impedance of less than 50mΩ.

Fig 1.3. V<sub>SBY</sub> Load Regul. (pulse condition)





**Fig 1.4. Ground Current** is shown across the entire range of load conditions. The ground current of 2mA has minimal variation across the range of load conditions and shows only a slight increase at maximum load due to the current limit protection circuitry.

**Fig 1.4. Ground Current**

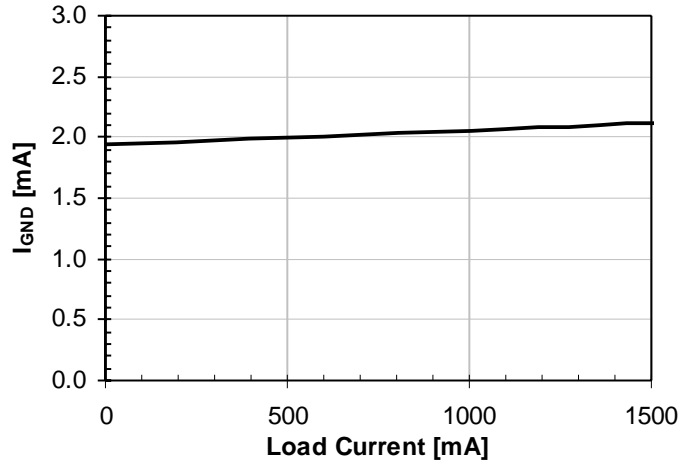

**Fig 1.5. Supply Current** of the device is shown across the entire V<sub>CC</sub> range.

The supply current remains below 0.2mA when the V<sub>CC</sub> supply is lower than 4.2V and the regulator is deselected. Above this point, the regulator is enabled and a supply current of 2.0mA is conducted.

**Fig 1.5. Vcc Supply Current (No Load)**

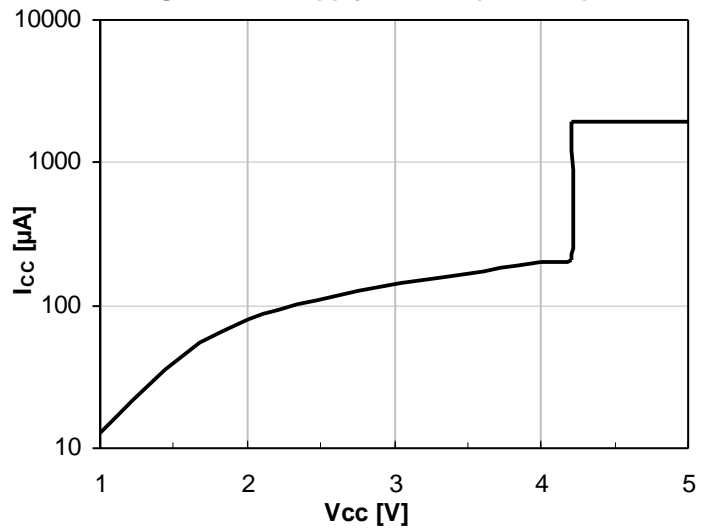



Typical Transient Characteristics

The transient characterization test setup shown below includes the effective source impedance of the  $V_{CC}$  supply ( $R_s$ ). This was measured to be approximately  $0.1\Omega$ . It is recommended that this effective source impedance be no greater than  $0.15\Omega$  to ensure precise switching is maintained during  $V_{CC}$  selection and deselection.

Both the rise and fall times during  $V_{CC}$  power-up/down sequencing were controlled to be around 10 milliseconds duration. This is considered to represent worst case conditions for most application circuits.

During a selection or deselection transition the DC load current is switching from  $V_{AUX}$  to  $V_{CC}$  and vice versa, or from  $V_{SBY}$  to  $V_{CC}$ . In addition to the normal load current there may also be an in-rush current for charging/discharging the load capacitor.

The total current pulse being applied to either  $V_{AUX}$  or  $V_{CC}$  is equal to the sum of the dc load and the corresponding in-rush current. Transient currents in excess of one amp can readily occur for brief intervals when either supply commences to power the load.

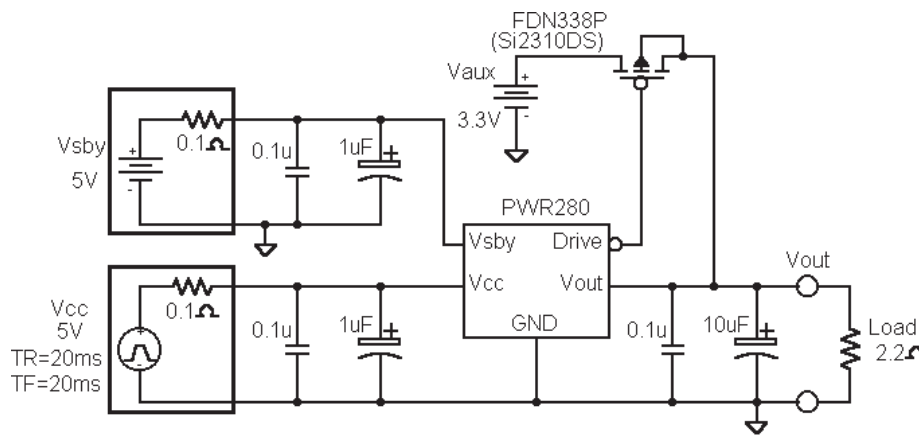

Transient Performance Test Setup

**$V_{CC}$  Load Transient Response** is shown for a step load from 15mA to 1500mA. An overshoot of approximately 300mV is observed, before settling within 3μs.

**$V_{SBY}$  Load Transient Response** is shown for a step load from 5mA to 375mA. An overshoot of approximately 100mV is observed, before settling within 1μs.

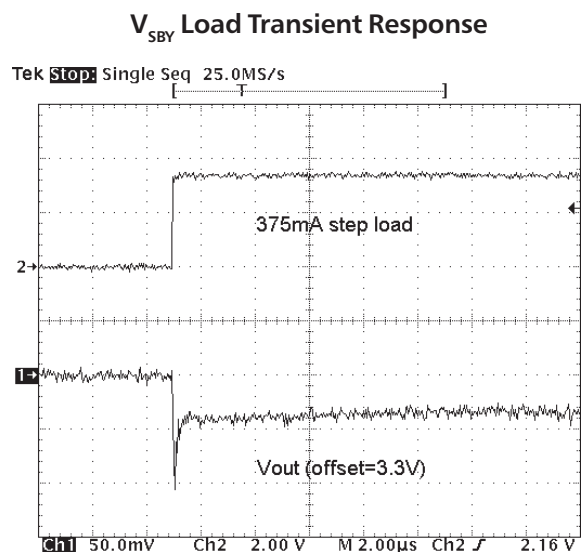
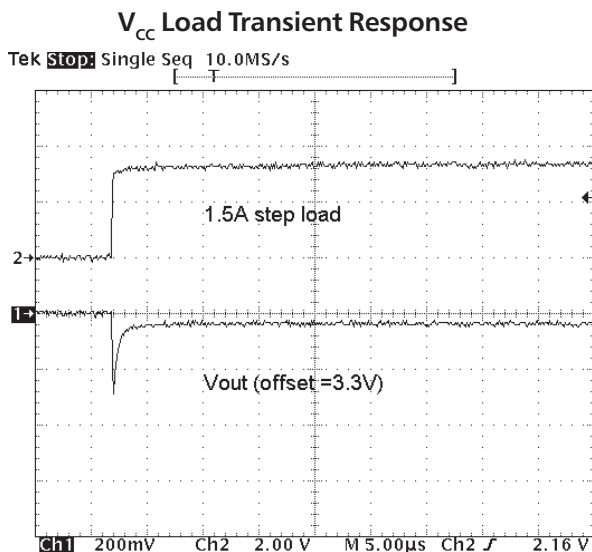



Typical Transient Characteristics - Cold Start and Full Power Down

Fig 2.1  $V_{CC}$  cold start

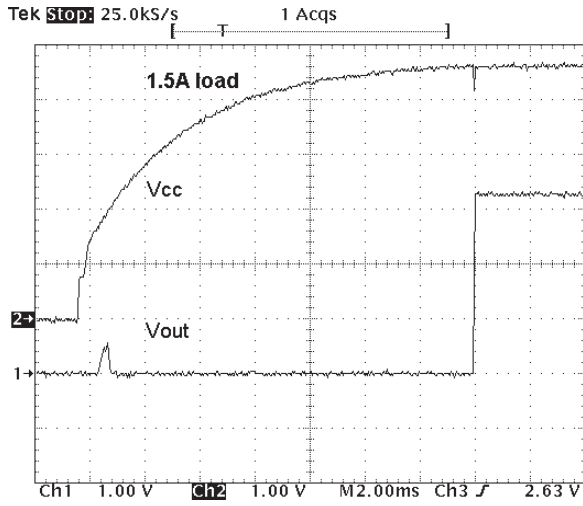

Fig 2.2  $V_{CC}$  full power down

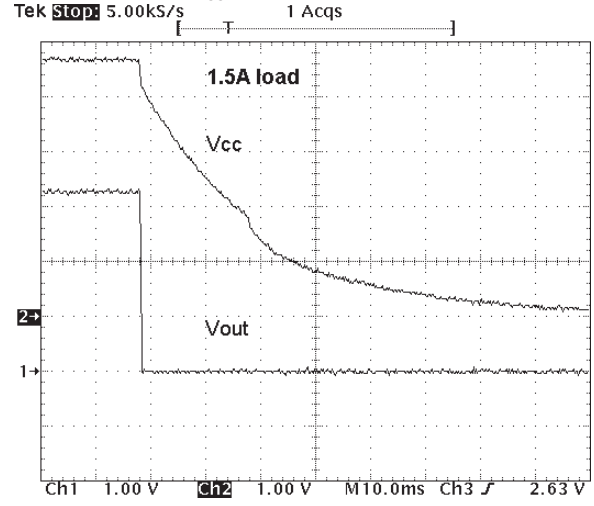

Fig 2.3  $V_{SBY}$  cold start

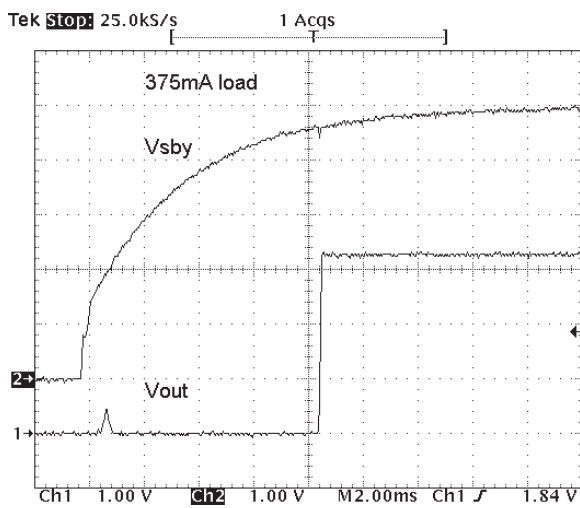
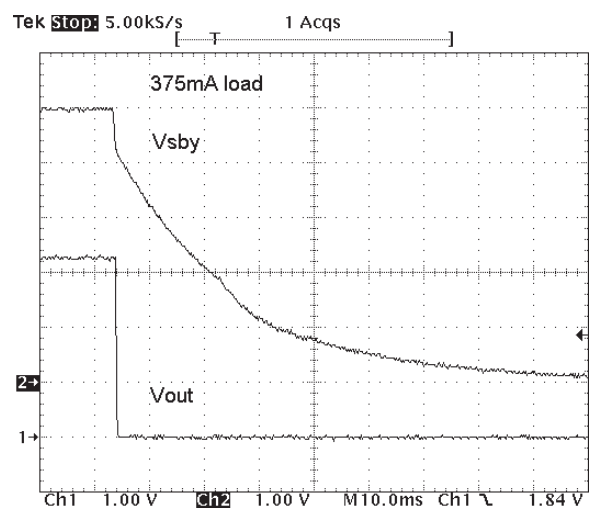

Fig 2.4  $V_{SBY}$  full power down





Typical Transient Characteristics - V<sub>CC</sub> Power Changeover

Fig 2.7 V<sub>CC</sub> power up (V<sub>SBY</sub> = 5V)

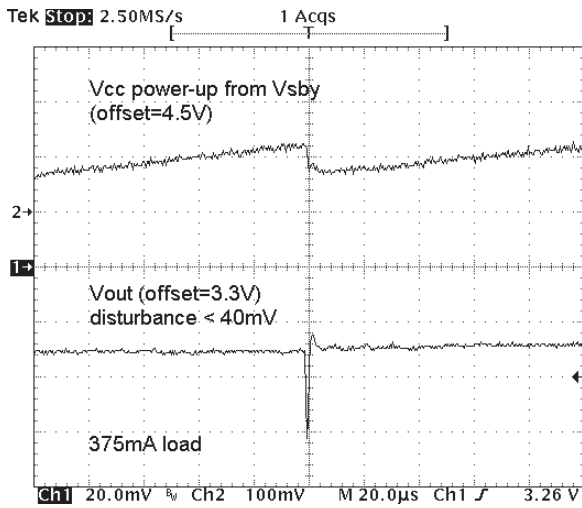

Fig 2.8 V<sub>CC</sub> power down (V<sub>SBY</sub> = 5V)

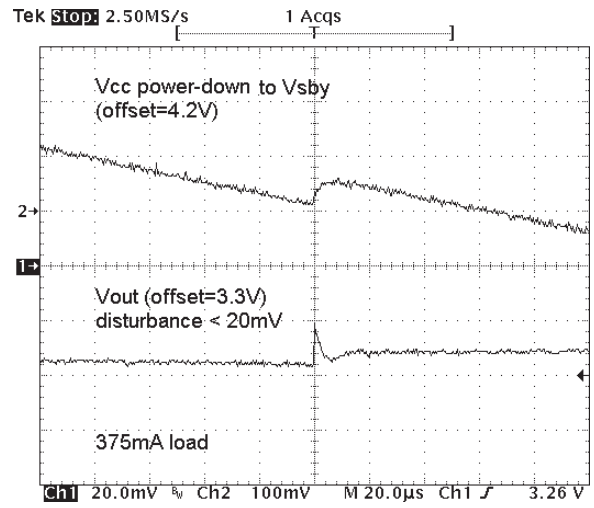

Fig 2.9 V<sub>CC</sub> power up (V<sub>AUX</sub> = 3.3V)

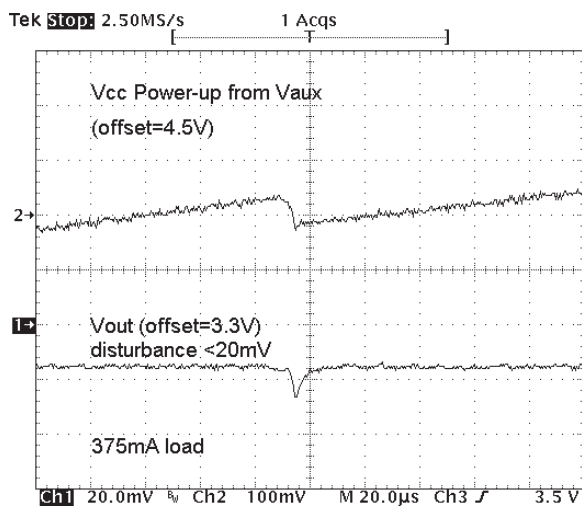

Fig 2.10 V<sub>CC</sub> power down (V<sub>AUX</sub> = 3.3V)

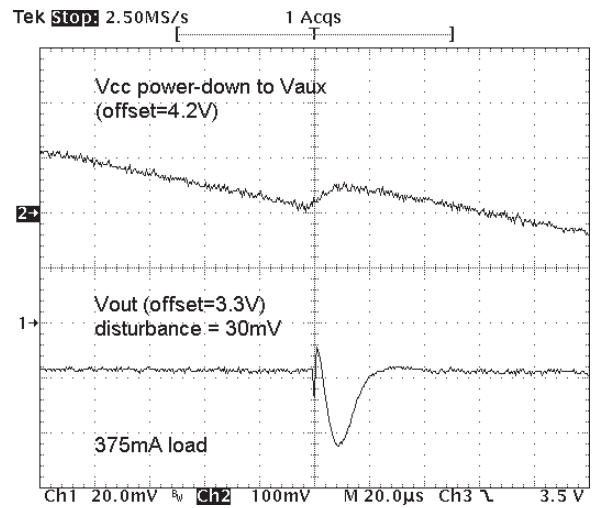

Fig 2.11 V<sub>CC</sub> power up (V<sub>AUX</sub> = 3.0V)

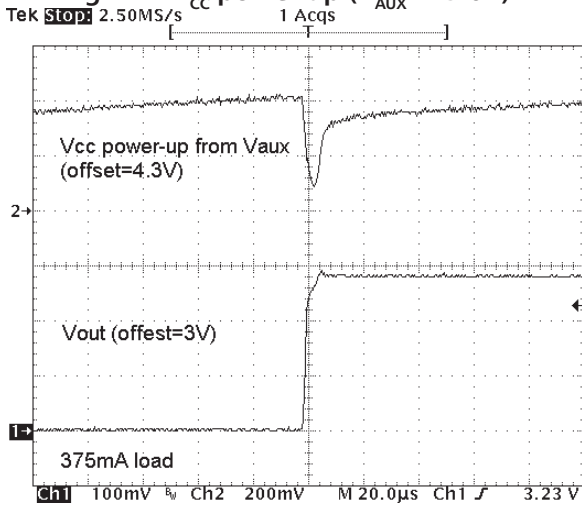
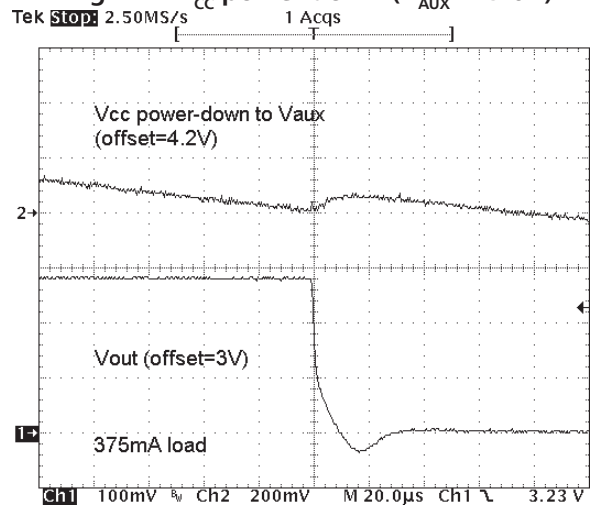

Fig 2.12 V<sub>CC</sub> power down (V<sub>AUX</sub> = 3.0V)







Typical Thermal Characteristics

Thermal dissipation of junction heat consists primarily of two paths in series. The first path is the junction to the case ( $\theta_{JC}$ ) thermal resistance which is defined by the package style, and the second path is the case to ambient ( $\theta_{CA}$ ) thermal resistance, which is dependent on board layout. The overall junction to ambient ( $\theta_{JA}$ ) thermal resistance is equal to:

$$\theta_{JA} = \theta_{JC} + \theta_{CA}$$

For a given package style and board layout, the operating junction temperature is a function of junction power dissipation  $P_{JUNC}$  and the ambient temperature, resulting in the following thermal equation:

$$T_{JUNC} = T_{AMB} + P_{JUNC} (\theta_{JC}) + P_{JUNC} (\theta_{CA})$$

$$= T_{AMB} + P_{JUNC} (\theta_{JA})$$

The CMPWR280TO is housed in a TO-263 5-lead package, which provides a  $\theta_{JC}$  of 3°C/W. The ground tab is soldered down to the PCB. When the device is mounted on a double sided printed circuit board with two square inches of copper allocated for "heat spreading", the resulting  $\theta_{JA}$  is 25°C/W.

Based on a maximum power dissipation of 2.85W (1.9Vx1.5A) with an ambient of 70°C the resulting junction temperature will be:

$$T_{JUNC} = T_{AMB} + P_{JUNC} (\theta_{JA})$$

$$= 70^{\circ}\text{C} + 2.85\text{W} (25^{\circ}\text{C/W})$$

$$= 70^{\circ}\text{C} + 71^{\circ}\text{C} = 141^{\circ}\text{C}$$

All thermal characteristics of the CMPWR280TO were measured using a double sided board with two square inches of copper area connected to the GND pins for "heat spreading".

Measurements showing performance up to junction temperature of 125°C were performed under light load conditions (5mA). This allows the ambient temperature to be representative of the internal junction temperature.

**Note:** The use of multi-layer board construction with power planes will further enhance the thermal performance of the package. In the event of no copper area being dedicated for heat spreading, a multi-layer board construction will typically provide the CMPWR280TO with an overall  $\theta_{JA}$  of 25°C/W which allows up to 2.5W to be safely dissipated.

**Fig 3.1. Output Voltage vs. Temperature.** This shows the regulator  $V_{OUT}$  performance up to the maximum rated junction temperature. The overall 125°C variation in junction temperature causes an output voltage change of about 25mV.

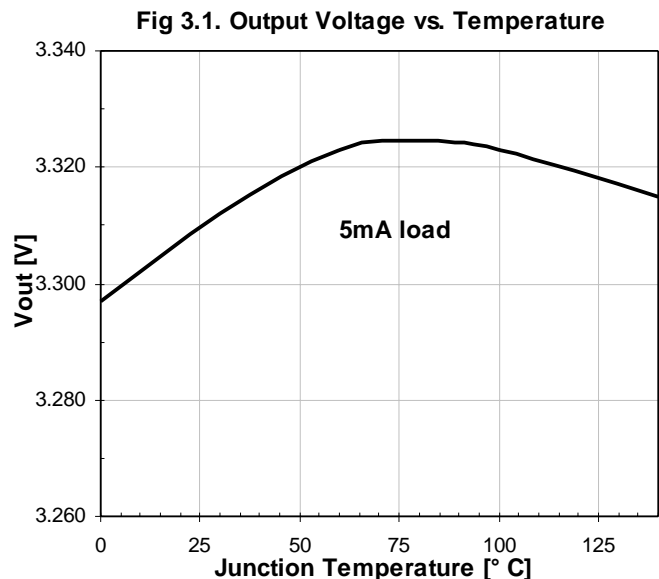



## Typical Thermal Characteristics cont'd

**Fig 3.2. Output Voltage (Rated) vs. Temperature.** This shows the regulator steady state performance when fully loaded (1.5A) in an ambient temperature up to the rated maximum of 70°C. The output variation at maximum load is about 13mV across the normal temperature operating.

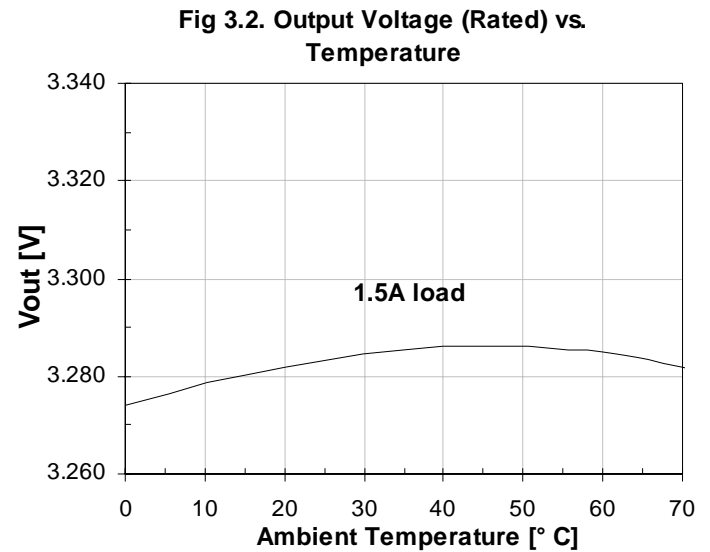

**Fig 3.3. Thresholds vs. Temperature.** This shows the regulator select/deselect threshold variation up to the maximum rated junction temperature. The overall 125°C change in junction temperature causes a 30mV variation in the select threshold voltage (regulator enable). The deselect threshold level varies about 30mV over the 125°C change in junction temperature. The hysteresis remains essentially constant over the entire temperature range.

